

# 1A Low Noise High Current LED Charge Pump with Independent Torch/Flash Current Control

## FEATURES

- High Efficiency Operation: 1x, 1.5x or 2x Boost Modes with Automatic Mode Switching
- Ultralow Dropout  $I_{LED}$  Current Control
- Output Current up to 1A
- Low Noise Constant Frequency Operation\*
- Independent Low Current/High Current Programming and Enable Pins
- Wide  $V_{IN}$  Range: 2.9V to 4.4V
- Open/Shorted LED Protection
- LED Disconnect in Shutdown
- Low Shutdown Current: 2.5 $\mu$ A
- 4% LED Current Programming Accuracy
- Automatic Soft-Start Limits Inrush Current
- No Inductors
- Tiny Application Circuit (All Components <1mm Profile)
- 3mm  $\times$  4mm 12-Lead DFN Package

## APPLICATIONS

- LED Torch/Camera Light Supply for Cell Phones, PDAs and Digital Cameras
- Generic Lighting and/or Flash/Strobe Applications

## DESCRIPTION

The LTC<sup>®</sup>3216 is a low noise, high current charge pump DC/DC converter designed to power high current LEDs. The part includes an accurate programmable current source capable of driving loads up to 1A from a 2.9V to 4.4V input. Low external parts count (two flying capacitors, two programming resistors and two bypass capacitors at  $V_{IN}$  and CPO) make the LTC3216 ideally suited for small, battery-powered applications.

Built-in soft-start circuitry prevents excessive inrush current during start-up. High switching frequency enables the use of small external capacitors. Independent high and low current settings are programmed by two external resistors. Shutdown mode and current output levels are selected via two logic inputs.

An ultralow dropout current source maintains accurate LED current at very low  $I_{LED}$  voltages. Automatic mode switching optimizes efficiency by monitoring the voltage across the LED current source and switching modes only when  $I_{LED}$  dropout is detected. The LTC3216 is available in a small 3mm  $\times$  4mm 12-Lead DFN package.

**LT**, LTC and LT are registered trademarks of Linear Technology Corporation. All other trademarks are the property of their respective owners.  
 \*Protected by U.S. Patents including 6411531.

## TYPICAL APPLICATION

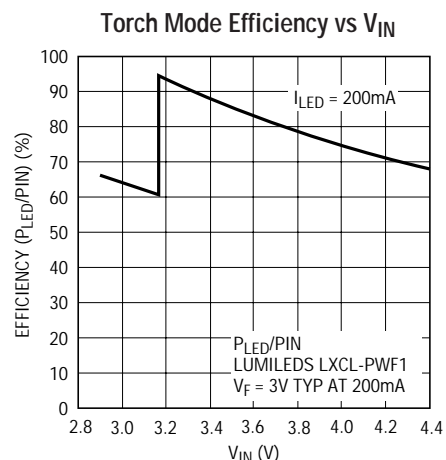
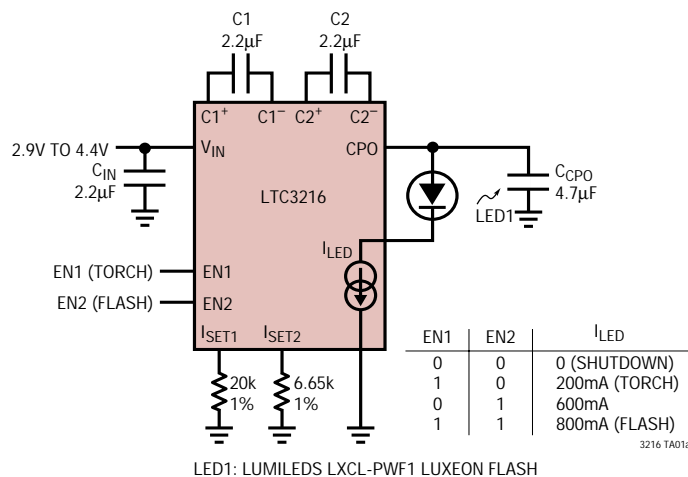

## ABSOLUTE MAXIMUM RATINGS

(Note 1)

$V_{IN}$ to GND .....	-0.3V to 5.5V
CPO to GND .....	-0.3V to 5.5V
EN2, EN1 .....	-0.3V to $V_{IN} + 0.3V$
$I_{CPO}$ , $I_{LED}$ (Note 2) .....	1500mA
CPO Short-Circuit Duration .....	Indefinite
Operating Temperature Range (Note 3) ...	-40°C to 85°C
Storage Temperature Range .....	-65°C to 125°C

## PACKAGE/ORDER INFORMATION

<p>DE12 PACKAGE 12-LEAD (4mm x 3mm) PLASTIC DFN EXPOSED PAD IS GND (PIN 13) MUST BE SOLDERED TO PCB <math>T_{JMAX} = 125^{\circ}C</math>, <math>\theta_{JA} = 43^{\circ}C/W</math></p>	ORDER PART NUMBER
	LTC3216EDE
	DFN PART MARKING
	3216

Consult LTC Marketing for parts specified with wider operating temperature ranges.

## ELECTRICAL CHARACTERISTICS

The ● denotes the specifications which apply over the full operating temperature range, otherwise specifications are at  $T_A = 25^{\circ}C$ .  $V_{IN} = 3.6V$ ,  $C_{IN} = C1 = C2 = 2.2\mu F$ ,  $C_{CPO} = 4.7\mu F$

PARAMETER	CONDITIONS	MIN	TYP	MAX	UNITS
<b>Input Power Supply</b>					
$V_{IN}$ Operating Voltage		● 2.9		4.4	V
$I_{VIN}$ Operating Current	$I_{CPO} = 0mA$ , 1x Mode $I_{CPO} = 0mA$ , 1.5x $I_{CPO} = 0mA$ , 2x Mode		300 7 9.2		$\mu A$ mA mA
$I_{VIN}$ Shutdown Current	EN2 = EN1 = LOW		2.5	7	$\mu A$
<b>LED Current</b>					
LED Current Ratio ( $I_{LED}/I_{SET1/2}$ )	$I_{LED} = 200mA$ to 800mA	● 3120	3250	3380	mA/mA
$I_{LED}$ Dropout Voltage	Mode Switch Threshold, $I_{LED} = 200mA$		120		mV
Mode Switching Delay (LED Warmup Time)	EN1 = HIGH, EN2 = LOW EN1 = LOW or HIGH, EN2 = HIGH		150 2		ms ms
LED Current On Time	EN $\downarrow$ to LED Current On		130		$\mu s$
<b>Charge Pump (CPO)</b>					
1x Mode Output Voltage	$I_{CPO} = 0mA$		$V_{IN}$		V
1.5x Mode Output Voltage	$I_{CPO} = 0mA$		4.6		V
2x Mode Output Voltage	$I_{CPO} = 0mA$		5.1		V
1x Mode Output Impedance			0.25		$\Omega$
1.5x Mode Output Impedance	$V_{IN} = 3.4V$ , $V_{CPO} < 4.6V$ , $C1 = C2 = 2.2\mu F$		1.5		$\Omega$
2x Mode Output Impedance	$V_{IN} = 3.2V$ , $V_{CPO} < 5.1V$ , $C1 = C2 = 2.2\mu F$		1.7		$\Omega$
CLK Frequency		● 0.6	0.9	1.2	MHz
<b>EN1, EN2</b>					
High Level Input Voltage ( $V_{IH}$ )		● 1.4			V
Low Level Input Voltage ( $V_{IL}$ )		●		0.4	V
Input Current ( $I_{IH}$ )		● -1		1	$\mu A$
Input Current ( $I_{IL}$ )		● -1		1	$\mu A$

# ELECTRICAL CHARACTERISTICS

The ● denotes the specifications which apply over the full operating temperature range, otherwise specifications are at  $T_A = 25^\circ\text{C}$ .  $V_{IN} = 3.6\text{V}$ ,  $C_{IN} = C1 = C2 = 2.2\mu\text{F}$ ,  $C_{CPO} = 4.7\mu\text{F}$

PARAMETER	CONDITIONS	MIN	TYP	MAX	UNITS
$I_{SET1}$ , $I_{SET2}$					
$V_{ISET1}$ , $V_{ISET2}$	$I_{SETX} = 50\mu\text{A}$	● 1.195	1.22	1.245	V
$I_{ISET1}$ , $I_{ISET2}$		●		321	$\mu\text{A}$

**Note 1:** Absolute Maximum Ratings are those values beyond which the life of a device may be impaired.

**Note 2:** Based on long-term current density limitations. Assumes an operating duty cycle of  $\leq 10\%$  under absolute maximum conditions for durations less than 10 seconds. Max current for continuous operation is 500mA.

**Note 3:** The LTC3216E is guaranteed to meet performance specifications from  $0^\circ\text{C}$  to  $70^\circ\text{C}$ . Specifications over the  $-40^\circ\text{C}$  to  $85^\circ\text{C}$  operating temperature range are assured by design, characterization and correlation with statistical process controls.

## TYPICAL PERFORMANCE CHARACTERISTICS

$T_A = 25^\circ\text{C}$  unless otherwise noted.

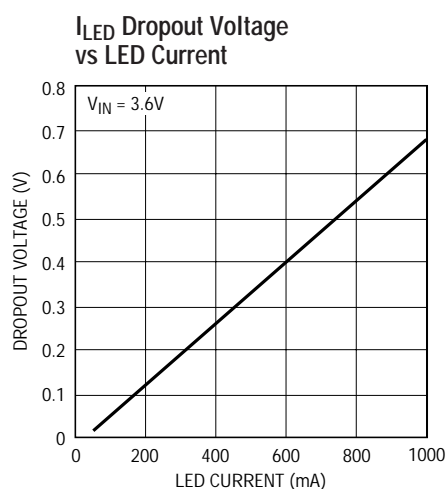

3216 G01

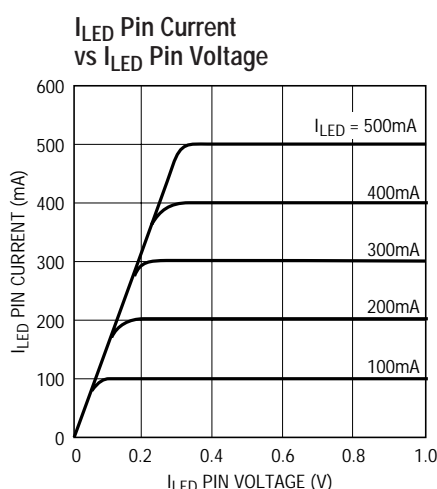

3216 G02

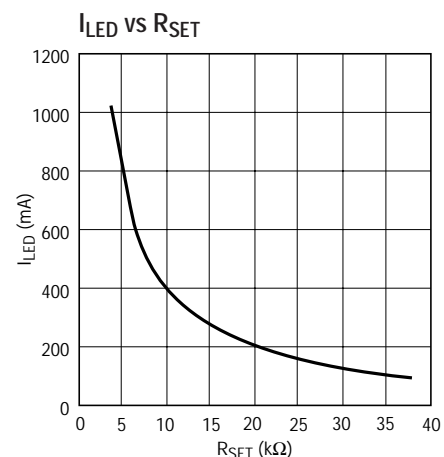

1573 G06

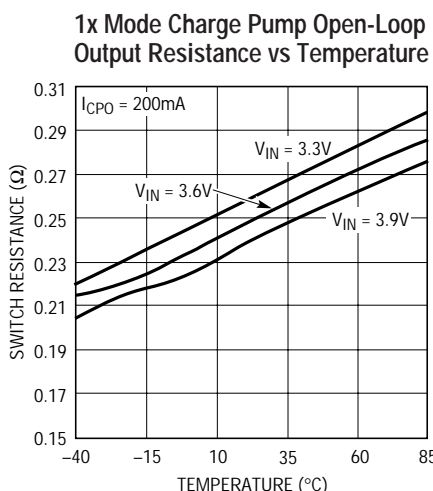

3216 G07

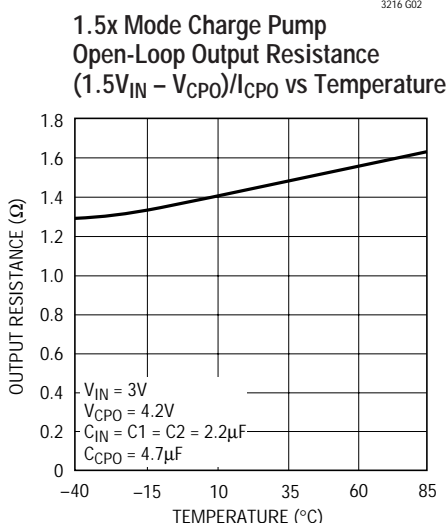

3216 G05

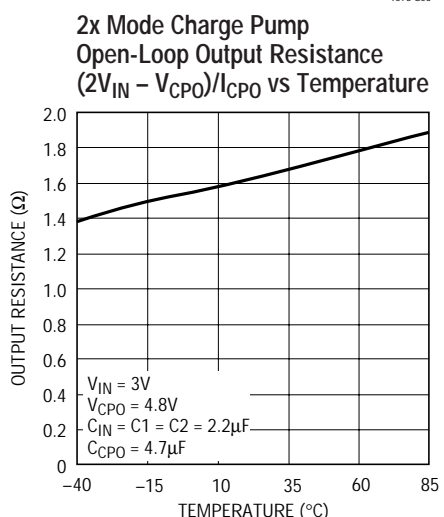

3216 G06

## TYPICAL PERFORMANCE CHARACTERISTICS $T_A = 25^\circ\text{C}$ unless otherwise noted.

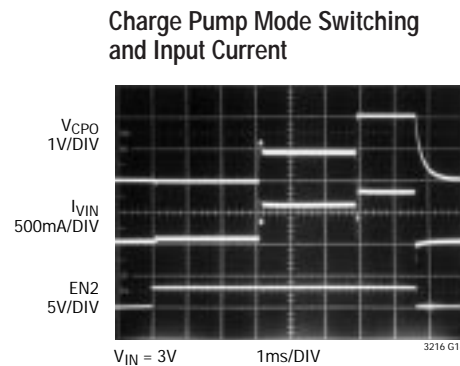
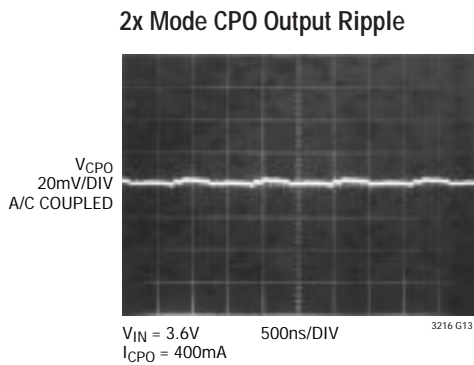
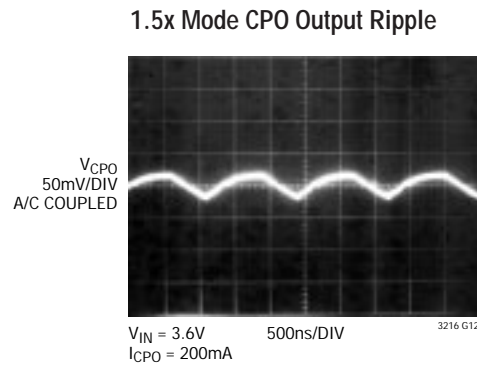
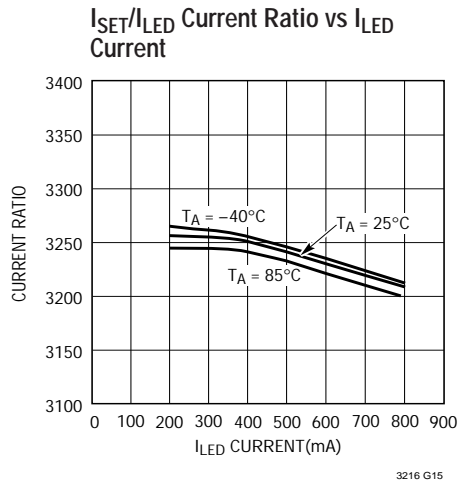
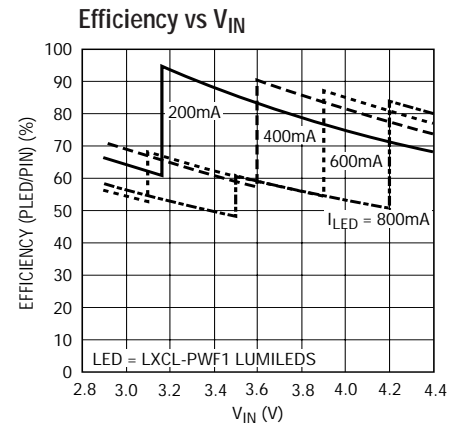
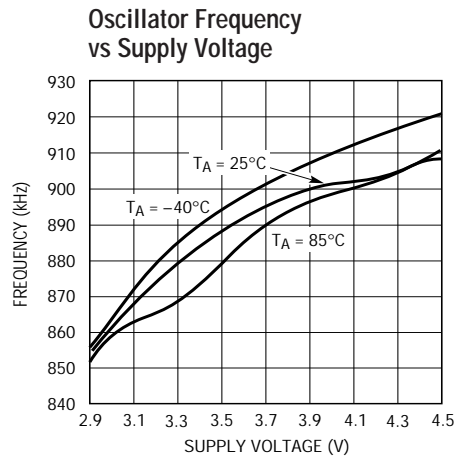
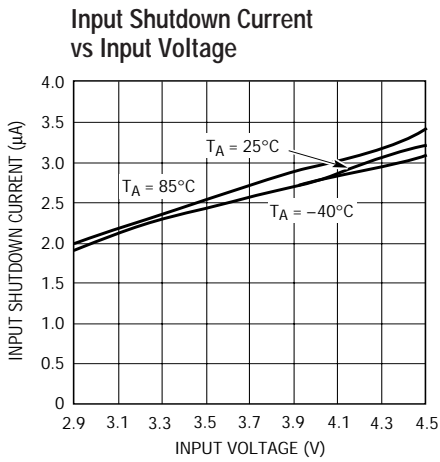

## PIN FUNCTIONS

**C2<sup>+</sup>, C1<sup>+</sup>, C2<sup>-</sup>, C1<sup>-</sup> (Pins 1, 2, 10, 12):** Charge Pump Flying Capacitor Pins. A 2.2 $\mu$ F X5R or X7R ceramic capacitor should be connected from C1<sup>+</sup> to C1<sup>-</sup> and from C2<sup>+</sup> to C2<sup>-</sup>.

**CPO (Pin 3):** Output. CPO is the output of the Charge Pump. This pin may be enabled or disabled using the EN1 and EN2 inputs. A 4.7 $\mu$ F X5R or X7R ceramic capacitor is required from CPO to GND.

**I<sub>SET1</sub>/I<sub>SET2</sub> (Pins 4, 6):** LED Current Programming Resistor Pins. The I<sub>SET1</sub> and I<sub>SET2</sub> pins will servo to 1.22V. Resistors connected between each of these pins and GND are used to set the high and low LED current levels. Connecting a resistor of 2k $\Omega$  or less will cause the LTC3216 to enter overcurrent shutdown mode.

**I<sub>LED</sub> (Pin 5):** Output. I<sub>LED</sub> is the LED current source output. The LED is connected between CPO (anode) and I<sub>LED</sub> (cathode). The current into the I<sub>LED</sub> pin is set via the EN1 and EN2 inputs, and the programming resistors connected from I<sub>SET2</sub> and I<sub>SET1</sub> to GND.

**EN1/EN2 (Pins 7, 8):** Inputs. The EN1 and EN2 pins are used to select which current level is being supplied to the LED, as well as to put the part into shutdown mode. The truth table for these pins is as follows:

Truth Table

EN1	EN2	MODE
0	0	Shutdown
1	0	Low Current
0	1	High Current
1	1	Low + High Current

**V<sub>IN</sub> (Pin 9):** Power. Supply voltage for the LTC3216. V<sub>IN</sub> should be bypassed with a 2.2 $\mu$ F or greater low impedance ceramic capacitor to GND.

**GND (Pin 11):** Charge Pump Ground. This pin should be connected directly to a low impedance ground plane.

**EXPOSED PAD (Pin 13):** Control Signal Ground. This pad must be soldered to a low impedance ground plane for optimum thermal and electrical performance.

## BLOCK DIAGRAM

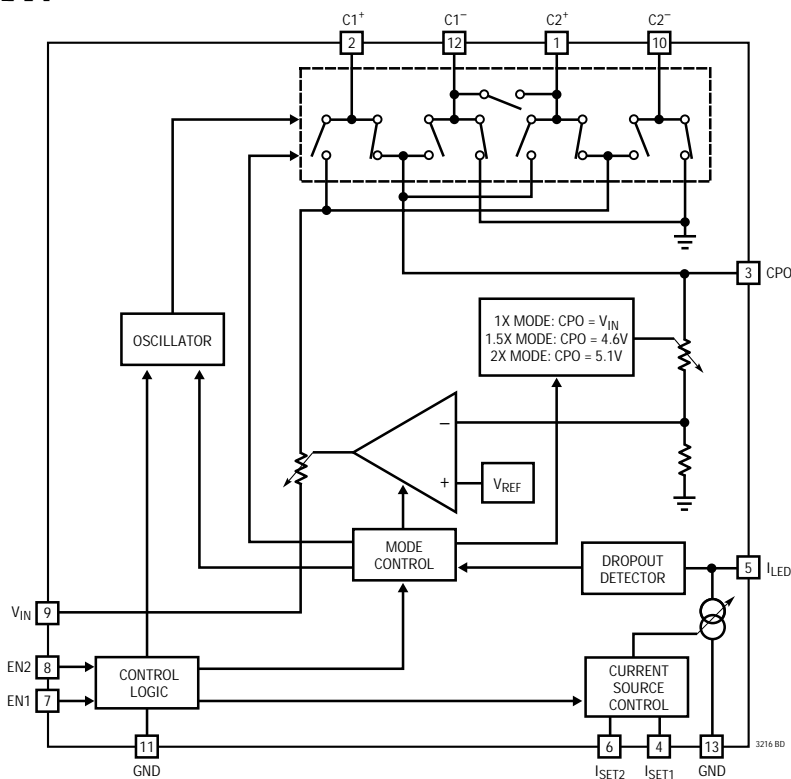

3216fa

## OPERATION

The LTC3216 uses a fractional switched capacitor charge pump to power a high current LED with a programmed regulated current. The part starts up into the 1x mode. In this mode,  $V_{IN}$  is directly connected to CPO. This mode provides maximum efficiency and minimum noise. The LTC3216 will remain in this mode until the LED current source begins to dropout. When dropout is detected, the LTC3216 will switch to 1.5x mode after a soft-start period. Any subsequent dropout detected will cause the part to enter 2x mode. The part may be reset to 1x mode by bringing the part into shutdown mode and then reenabling the part.

A two phase nonoverlapping clock activates the charge pump switches. In the 2x mode, the flying capacitors are charged on alternate clock phases from  $V_{IN}$ . While one capacitor is being charged from  $V_{IN}$ , the other is stacked on top of  $V_{IN}$  and connected to the output. Alternatively, in the 1.5x mode the flying capacitors are charged in series during the first clock phase, and stacked in parallel on top of  $V_{IN}$  on the second clock phase. This sequence of charging and discharging the flying capacitors continues at a free running frequency of 900kHz (typ).

The current delivered to the LED load is controlled by the internal programmable current source. Three discrete current settings (Low, High and Low + High) are available and may be selected via the EN2 and EN1 pins. The values of these currents may be selected by choosing the appropriate programming resistors. Each resistor is connected between the  $I_{SET2}$  or  $I_{SET1}$  pin and GND. The resistor values needed to attain the desired current levels can be determined by equation 1.

$$R_{SET1/2} = 3965/I_{LED} \quad (1)$$

A resistor value of 2k $\Omega$  or less (i.e. a short-circuit) will cause the LTC3216 to enter overcurrent shutdown mode. This mode will prevent damage to the part by shutting down the high power sections of the chip.

Regulation is achieved by sensing the voltage at the CPO pin and modulating the charge pump strength based on the error signal. The CPO regulation voltages are set

internally, and are dependent on the charge pump mode as shown in Table 1.

**Table 1. Charge Pump Output Regulation Voltages**

Charge Pump Mode	$V_{CPO}$
1.5x	4.6V
2x	5.1V

In shutdown mode all circuitry is turned off and the LTC3216 draws a very low current from the  $V_{IN}$  supply. Furthermore, CPO is weakly connected to  $V_{IN}$ . The LTC3216 enters shutdown mode when both the EN1 and EN2 pins are brought low. Since EN1 and EN2 are high impedance CMOS inputs they should never be allowed to float. To ensure that their states are defined they must always be driven with valid logic levels.

### Thermal Protection

The LTC3216 has built-in overtemperature protection. Thermal shutdown circuitry will shutdown the  $I_{LED}$  output when the junction temperature exceeds approximately 150°C. It will re-enable the  $I_{LED}$  output once the junction temperature drops back to approximately 135°C. The LTC3216 will cycle in and out of thermal shutdown indefinitely without latch up or damage until the heat source is removed.

### Soft-Start

To prevent excessive inrush current during start-up and mode switching, the LTC3216 employs built-in soft-start circuitry. Soft-start is achieved by increasing the amount of current available to the output charge storage capacitor linearly over a period of approximately 250 $\mu$ s.

### Charge Pump Strength

When the LTC3216 operates in either the 1.5x mode or 2x mode, the charge pump can be modeled as a Thevenin-equivalent circuit to determine the amount of current available from the effective input voltage and effective open-loop output resistance,  $R_{OL}$  (Figure 1).

## OPERATION

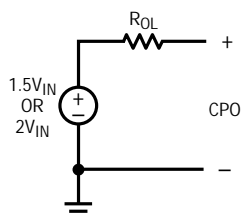

Figure 1. Charge Pump Open-Loop Thevenin-Equivalent Circuit

$R_{OL}$  is dependent on a number of factors including the oscillator frequency, flying capacitor values and switch resistances.

From Figure 1, we can see that the output current is proportional to:

$$(1.5V_{IN} - CPO)/R_{OL} \text{ or } (2V_{IN} - CPO)/R_{OL} \quad (2)$$

in the 1.5x mode or 2x mode respectively.

### Current Levels

The LTC3216 may be programmed to have three discrete current levels. These are the LOW, HIGH and LOW + HIGH current levels. The LOW and HIGH currents are set by the resistors connected between  $I_{SET1}$  and  $I_{SET2}$  pins, respectively, to GND. The LOW + HIGH current mode supplies a current that is equal to sum of the LOW and HIGH currents.

Due to the low output impedance of this part, care should be taken in selecting current levels. This part can supply up

to 500mA continuously, and up to 1A for pulsed operation with a 10% duty cycle. Pulsed operation may be achieved by toggling the EN1 and EN2 bits. In either continuous or pulsed operation, proper board layout is required for effective heat sinking.

### Mode Switching

The LTC3216 will automatically switch from 1x mode to 1.5x mode, and subsequently from 1.5x mode to 2x mode whenever a dropout condition is detected at the  $I_{LED}$  pin. In the LOW current mode, the part will wait approximately 150ms after dropout is detected before switching to the next mode. In the HIGH and LOW + HIGH current modes, the part will wait approximately 2ms before switching to the next mode. These delays allow the LED to warm up and reduce its forward voltage which may remove the dropout condition.

In order to reset the part back into 1x mode, the LTC3216 must be brought into shutdown ( $EN1 = EN2 = LOW$ ). Immediately after the part has been brought to shutdown, it may be set to the desired output current level via the EN1 and EN2 pins. An internal comparator will not allow the main switches to connect  $V_{IN}$  and CPO in 1x mode until the voltage at the CPO pin has decayed to less than or equal to the voltage at the  $V_{IN}$  pin.

## APPLICATIONS INFORMATION

### $V_{IN}$ , CPO Capacitor Selection

The style and value of capacitors used with the LTC3216 determine several important parameters such as regulator control loop stability, output ripple, charge pump strength and minimum start-up time.

To reduce noise and ripple, it is recommended that low equivalent series resistance (ESR) ceramic capacitors be used for both  $C_{VIN}$  and  $C_{CPO}$ . Tantalum and aluminum capacitors are not recommended because of their high ESR.

The value of  $C_{CPO}$  directly controls the amount of output ripple for a given load current. Increasing the size of  $C_{CPO}$  will reduce the output ripple at the expense of higher start-up current. The peak-to-peak output ripple for 1.5x mode is approximately given by the expression:

$$V_{RIPPLE(P-P)} = I_{OUT} / (3f_{OSC} \cdot C_{CPO}) \quad (3)$$

Where  $f_{OSC}$  is the LTC3216's oscillator frequency (typically 900kHz) and  $C_{CPO}$  is the output storage capacitor.

Both the style and value of the output capacitor can significantly affect the stability of the LTC3216. As shown in the block diagram, the LTC3216 uses a control loop to adjust the strength of the charge pump to match the current required at the output. The error signal of this loop is stored directly on the output charge storage capacitor. The charge storage capacitor also serves as the dominant pole for the control loop. To prevent ringing or instability, it is important for the output capacitor to maintain at least 2.2 $\mu$ F of actual capacitance over all conditions.

Likewise, excessive ESR on the output capacitor will tend to degrade the loop stability of the LTC3216. The closed loop output resistance of the LTC3216 is designed to be 76m $\Omega$ . For a 100mA load current change, the error signal will change by about 7.6mV. If the output capacitor has 76m $\Omega$  or more of ESR, the closed-loop frequency response will cease to roll off in a simple one-pole fashion and poor load transient response of instability could result. Multilayer ceramic chip capacitors typically have exceptional ESR performance. MLCCs combined with a tight board layout will yield very good stability. As the value

of  $C_{CPO}$  controls the amount of output ripple, the value of  $C_{VIN}$  controls the amount of ripple present at the input pin ( $V_{IN}$ ). The input current to the LTC3216 will be relatively constant while the charge pump is on either the input charging phase or the output charging phase but will drop to zero during the clock nonoverlap times. Since the nonoverlap time is small (~15ns), these missing "notches" will result in only a small perturbation on the input power supply line. Note that a higher ESR capacitor such as tantalum will have higher input noise due to the input current change times the ESR. Therefore, ceramic capacitors are again recommended for their exceptional ESR performance. Input noise can be further reduced by powering the LTC3216 through a very small series inductor as shown in Figure 2. A 10nH inductor will reject the fast current notches, thereby presenting a nearly constant current load to the input power supply. For economy, the 10nH inductor can be fabricated on the PC board with about 1cm (0.4") of PC board trace.

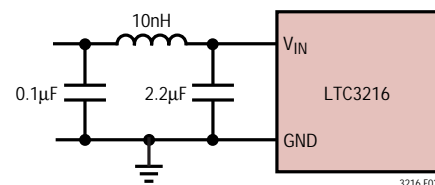

Figure 2. 10nH Inductor Used for Input Noise Reduction (Approximately 1cm of Wire)

### Flying Capacitor Selection

Warning: Polarized capacitors such as tantalum or aluminum should never be used for the flying capacitors since their voltage can reverse upon start-up of the LTC3216. Ceramic capacitors should always be used for the flying capacitors.

The flying capacitors control the strength of the charge pump. In order to achieve the rated output current it is necessary to have at least 2.2 $\mu$ F of actual capacitance for each of the flying capacitors. Capacitors of different materials lose their capacitance with higher temperature and voltage at different rates. For example, a ceramic capacitor made of X7R material will retain most of its capacitance



## APPLICATIONS INFORMATION

from  $-40^{\circ}\text{C}$  to  $85^{\circ}\text{C}$  whereas a Z5U or Y5V style capacitor will lose considerable capacitance over that range. Z5U and Y5V capacitors may also have a very poor voltage coefficient causing them to lose 60% or more of their capacitance when the rated voltage is applied. Therefore, when comparing different capacitors, it is often more appropriate to compare the amount of achievable capacitance for a given case size rather than comparing the specified capacitance value. For example, over rated voltage and temperature conditions, a  $1\mu\text{F}$ , 10V, Y5V ceramic capacitor in a 0603 case may not provide any more capacitance than a  $0.22\mu\text{F}$ , 10V, X7R available in the same case. The capacitor manufacturer's data sheet should be consulted to determine what value of capacitor is needed to ensure minimum capacitances at all temperatures and voltages.

Table 2 shows a list of ceramic capacitor manufacturers and how to contact them.

**Table 2. Recommended Capacitor Vendors**

AVX	<a href="http://www.avxcorp.com">www.avxcorp.com</a>
Kemet	<a href="http://www.kemet.com">www.kemet.com</a>
Murata	<a href="http://www.murata.com">www.murata.com</a>
Taiyo Yuden	<a href="http://www.t-yuden.com">www.t-yuden.com</a>
Vishay	<a href="http://www.vishay.com">www.vishay.com</a>
TDK	<a href="http://www.tdk.com">www.tdk.com</a>

### Layout Considerations and Noise

Due to its high switching frequency and the transient currents produced by the LTC3216, careful board layout is necessary. A true ground plane and short connections to all capacitors will improve performance and ensure proper regulation under all conditions.

The flying capacitor pins  $\text{C1}^+$ ,  $\text{C2}^+$ ,  $\text{C1}^-$  and  $\text{C2}^-$  will have very high edge rate waveforms. The large  $\text{dv/dt}$  on these pins can couple energy capacitively to adjacent PCB runs. Magnetic fields can also be generated if the flying capacitors are not close to the LTC3216 (i.e., the loop area is large). To decouple capacitive energy transfer, a Faraday shield may be used. This is a grounded PCB trace between the sensitive node and the LTC3216 pins. For a high quality AC ground, it should be returned to a solid ground plane that extends all the way to the LTC3216.

### Power Efficiency

To calculate the power efficiency ( $\eta$ ) of a white LED driver chip, the LED power should be compared to the input power. The difference between these two numbers represents lost power whether it is in the charge pump or the current sources. Stated mathematically, the power efficiency is given by:

$$\eta \equiv \frac{P_{\text{LED}}}{P_{\text{IN}}} \quad (4)$$

The efficiency of the LTC3216 depends upon the mode in which it is operating. Recall that the LTC3216 operates as a pass switch, connecting  $V_{\text{IN}}$  to CPO, until dropout is detected at the  $I_{\text{LED}}$  pin. This feature provides the optimum efficiency available for a given input voltage and LED forward voltage. When it is operating as a switch, the efficiency is approximated by:

$$\eta \equiv \frac{P_{\text{LED}}}{P_{\text{IN}}} = \frac{V_{\text{LED}} \cdot I_{\text{LED}}}{V_{\text{IN}} \cdot I_{\text{IN}}} \approx \frac{V_{\text{LED}}}{V_{\text{IN}}} \quad (5)$$

since the input current will be very close to the LED current.

At moderate to high output power, the quiescent current of the LTC3216 is negligible and the expression above is valid.

Once dropout is detected at the  $I_{\text{LED}}$  pin, the LTC3216 enables the charge pump in 1.5x mode.

In 1.5x boost mode, the efficiency is similar to that of a linear regulator with an effective input voltage of 1.5 times the actual input voltage. This is because the input current for a 1.5x charge pump is approximately 1.5 times the load current. In an ideal 1.5x charge pump, the power efficiency would be given by:

$$\eta_{\text{IDEAL}} \equiv \frac{P_{\text{LED}}}{P_{\text{IN}}} = \frac{V_{\text{LED}} \cdot I_{\text{LED}}}{V_{\text{IN}} \cdot 1.5I_{\text{LED}}} \approx \frac{V_{\text{LED}}}{1.5V_{\text{IN}}} \quad (6)$$

## TYPICAL APPLICATIONS

Similarly, in 2x boost mode, the efficiency is similar to that of a linear regulator with an effective input voltage of 2 times the actual input voltage. In an ideal 2x charge pump, the power efficiency would be given by:

$$\eta_{\text{IDEAL}} \equiv \frac{P_{\text{LED}}}{P_{\text{IN}}} = \frac{V_{\text{LED}} \cdot I_{\text{LED}}}{V_{\text{IN}} \cdot 2 \cdot I_{\text{LED}}} \approx \frac{V_{\text{LED}}}{2 \cdot V_{\text{IN}}} \quad (7)$$

### Thermal Management

For higher input voltages and maximum output current, there can be substantial power dissipation in the LTC3216. If the junction temperature increases above approximately 150°C, the thermal shutdown circuitry will automatically deactivate the output. To reduce maximum junction temperature, a good thermal connection to the PC board is recommended. Connecting the Exposed Pad to a ground plane and maintaining a solid ground plane under the device can reduce the thermal resistance of the package and PC board considerably.

## PACKAGE DESCRIPTION

DE Package  
12-Lead Plastic DFN (4mm × 3mm)  
(Reference LTC DWG # 05-08-1695)

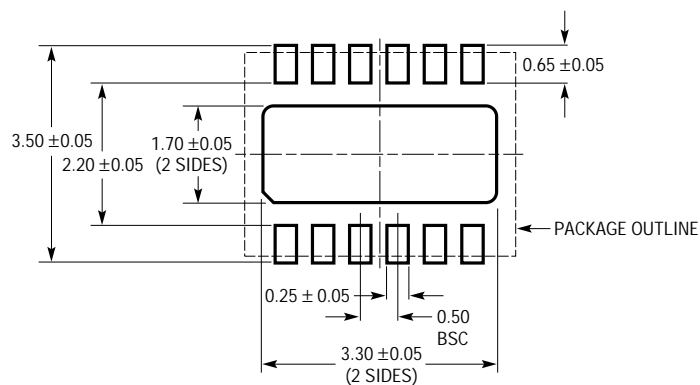

RECOMMENDED SOLDER PAD PITCH AND DIMENSIONS

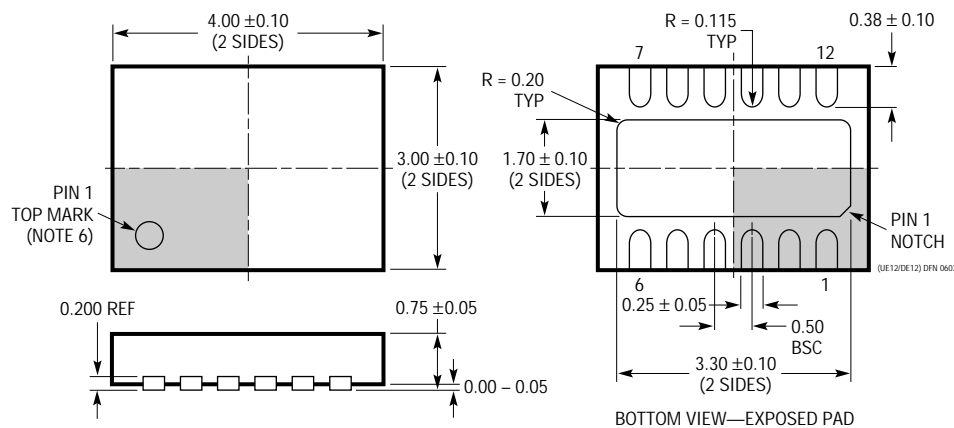

NOTE:

1. DRAWING PROPOSED TO BE A VARIATION OF VERSION (WGED) IN JEDEC PACKAGE OUTLINE MO-229
2. DRAWING NOT TO SCALE
3. ALL DIMENSIONS ARE IN MILLIMETERS
4. DIMENSIONS OF EXPOSED PAD ON BOTTOM OF PACKAGE DO NOT INCLUDE MOLD FLASH. MOLD FLASH, IF PRESENT, SHALL NOT EXCEED 0.15mm ON ANY SIDE
5. EXPOSED PAD SHALL BE SOLDER PLATED
6. SHADED AREA IS ONLY A REFERENCE FOR PIN 1 LOCATION ON THE TOP AND BOTTOM OF PACKAGE

## TYPICAL APPLICATION

High Power Camera Light and Flash

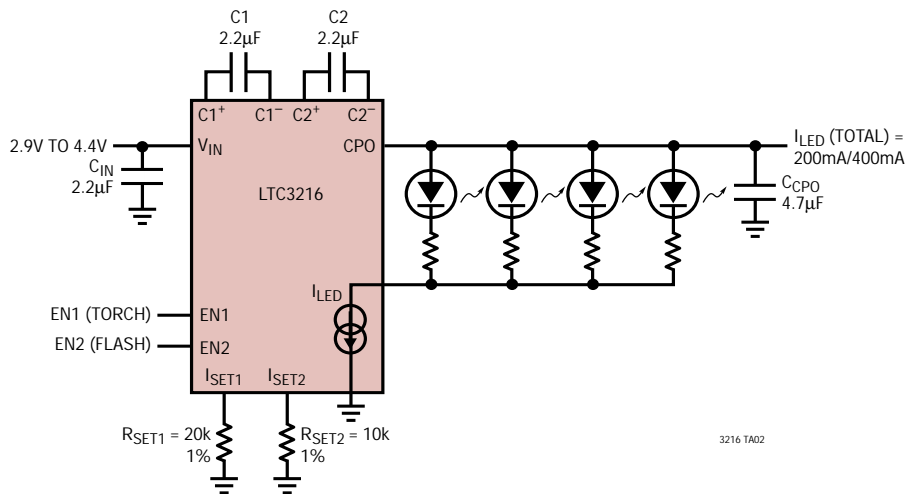

## RELATED PARTS

PART NUMBER	DESCRIPTION	COMMENTS
LT1618	Constant Current, 1.4MHz, 1.5A Boost Converter	$V_{IN}$ : 1.6V to 18V, $V_{OUT(MAX)}$ = 36V, $I_Q$ = 1.8mA, $I_{SD}$ < 1µA MS Package
LT1961	1.5A ( $I_{SW}$ ), 1.25MHz, High Efficiency Step-Up DC/DC Converter	$V_{IN}$ : 3V to 25V, $V_{OUT(MAX)}$ = 35V, $I_Q$ = 0.9mA, $I_{SD}$ 6µA MS8E Package
LTC3205	250mA, 1MHz, Multi-Display LED Controller	$V_{IN}$ : 2.8V to 4.5V, $V_{OUT(MAX)}$ = 5.5V, $I_Q$ = 50µA, $I_{SD}$ < 1µA DFN Package
LTC3206	400mA, 800kHz, Multi-Display LED Controller	$V_{IN}$ : 2.8V to 4.5V, $V_{OUT(MAX)}$ = 5.5V, $I_Q$ = 50µA, $I_{SD}$ < 1µA DFN Package
LTC3453	1MHz, 800mA Synchronous Buck-Boost High Power LED Driver	$V_{IN(MIN)}$ : 2.7V to 5.5V, $V_{IN(MAX)}$ : 2.7V to 4.5V, $I_Q$ = 2.5mA, $I_{SD}$ < 6µA QFN Package
LT3467/LT3467A	1.1A ( $I_{SW}$ ), 1.3/2.1MHz, High Efficiency Step-Up DC/DC Converter with Integrated Soft-Start	$V_{IN}$ : 2.4V to 16V, $V_{OUT(MAX)}$ = 40V, $I_Q$ = 1.2mA, $I_{SD}$ < 1µA ThinSOT Package
LT3479	3A, Full Featured DC/DC Converter with Soft-Start and Inrush Current Protection	$V_{IN}$ : 2.5V to 24V, $V_{OUT(MAX)}$ = 40V, $I_Q$ = 5mA, $I_{SD}$ < 1µA DFN, TSSOP Packages