

XC62K Series

Negative Voltage Regulators



- ◆ CMOS Low Power Consumption
- ◆ Small Input-Output Voltage Differential
 - : 0.12V @ 50mA,
 - 0.38V @ 100mA
- ◆ Maximum Output Current : 100mA (V_{OUT}=-5.0V)
- ◆ Highly Accurate : ±2% (±1%)
- ◆ Output Voltage Range : -2.1V ~ -6.0V
- ◆ Supply Current : 3.0μA (V_{OUT}=-5.0V)
- ◆ SOT-23/SOT-89/TO-92 Package

General Description

The XC62K series are highly precise, low power consumption, negative voltage regulators, manufactured using CMOS and laser trimming technologies. The series achieves high output currents with small input-output voltage differentials, and consists of a high precision voltage reference, an error correction circuit, and an output driver with current limitation.

SOT-23 (150mW), SOT-89 (500mW) and TO-92 (300mW) packages are available.

Applications

- Battery Powered Equipment
- Portable & Cellular Phones
- Various Portable Equipment
- Power Supply for GaAs Applications

3

Features

- Ultra Small Input-Output Voltage Differential** : 50mA output possible with a 0.12V differential (V_{OUT}=-5.0V).
- Maximum Output Current** : 100mA (within max. power dissipation, V_{OUT}= -5.0V)
- Output Voltage Range** : -2.1V ~ -6.0V in 0.1V increments.
-5.0, -4.0, -3.0V, -2.5V standard.
(All other voltages are semi-custom)
- Highly Accurate** : Output voltage ±2%
(±1% for semi-custom products)
- Low Power Consumption** : Typ. 3.0μA @ V_{OUT}= -5.0V
- Output Voltage Temperature Characteristics** : Typ. ±100ppm/°C
- Input Stability** : Typ. 0.1%/V
- Ultra Small Packages** : SOT-23 (150mW) mini-mold,
SOT-89 (500mW) mini-power mold
TO-92 (300mW)

Typical Application Circuit

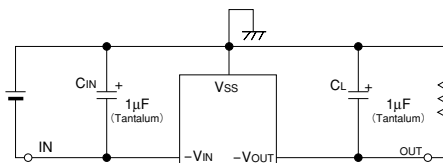

Typical Performance Characteristic

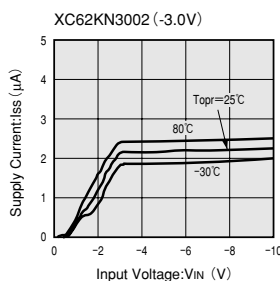

XC62K Series

Pin Configuration

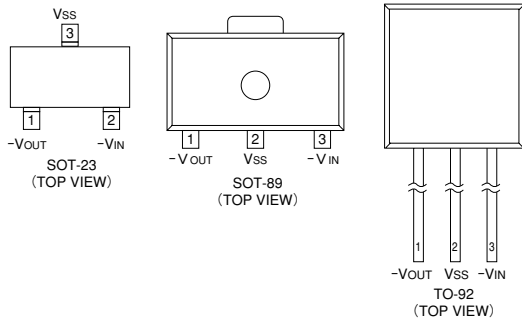

3

Pin Assignment

PIN NUMBER			PIN NAME	FUNCTION
SOT-23	SOT-89	TO-92		
2	3	3	-VIN	Power Supply Input
3	2	2	VSS	Ground
1	1	1	-VOUT	Output

Product Classification

Ordering Information

X C 6 2 K X X X X X X X
 ↑ ↑ ↑ ↑ ↑ ↑
 a b c d e f

DESIGNATOR	DESCRIPTION	DESIGNATOR	DESCRIPTION
a	<u>Polarity of Output Voltage</u> N=Negative	e	<u>Package Type</u> M=SOT-23 P=SOT-89 T=TO-92 (Standard)
b	<u>Output Voltage</u> 30=3.0V 50=5.0V		
c	<u>Temperature Characteristics</u> 0=±100ppm/°C (typical)	f	<u>Device Orientation</u> R=Embossed Tape (Standard Feed) L=Embossed Tape (Reverse Feed) H=Paper Tape (TO-92) B=Bag (TO-92)
d	<u>Accuracy</u> 1=±1.0% (Semi-custom products) 2=±2.0%		

■ Packaging Information

● SOT-23

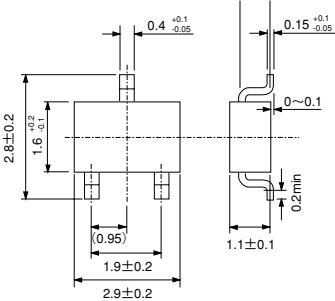

3

● SOT-89

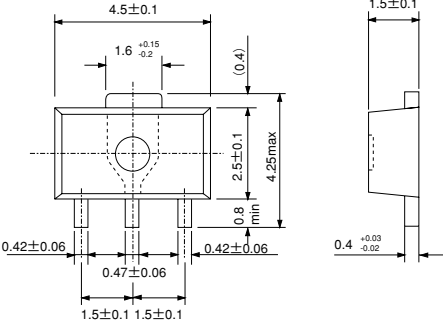

XC62K Series

●TO-92

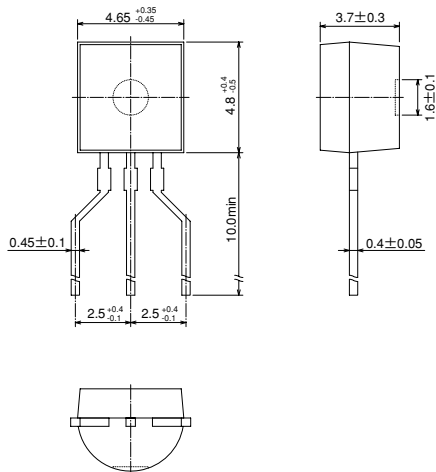

3

■Marking

●SOT-23, SOT-89

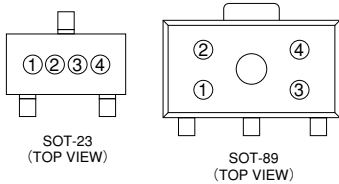

① Integral Number of Output Voltage

DESIGNATOR	VOLTAGE(V)	DESIGNATOR	VOLTAGE(V)
2	2.②	5	5.②
3	3.②	6	6.②
4	4.②		

② Decimal number of Output Voltage

DESIGNATOR	VOLTAGE(V)	DESIGNATOR	VOLTAGE(V)
A	①.0	F	①.5
B	①.1	H	①.6
C	①.2	K	①.7
D	①.3	L	①.8
E	①.4	M	①.9

③ Polarity of Output Voltage

DESIGNATOR	POLARITY
5	Negative

④ Assembly Lot Number Based on internal standards.

XC62K
Series

●TO-92

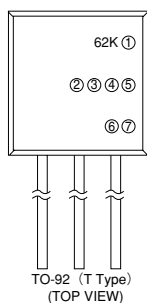

① Represents the Polarity of Output Voltage

DESIGNATOR	OUTPUT CONFIGURATION
N	—

④ Represents the temperature Characteristics

DESIGNATOR	TEMPERATURE CHARACTERISTICS
0	TPY±100ppm

⑤ Represents the Detect Voltage Accuracy

DESIGNATOR	DETECT VOLTAGE ACCURACY
1	within ±1% (semi-custom)
2	within ±2%

⑥ Represents a least significant digit of the produced year

DESIGNATOR	PRODUCED YEAR
0	2000
1	2001

⑦ Denotes the production lot number

0 to 9, A to Z repeated(G,I,J,O,Q,W excepted)

②③ Represents the Detect Voltage

DESIGNATOR		VOLTAGE (V)
②	③	
3	3	3.3
5	0	5.0

3

■Block Diagram

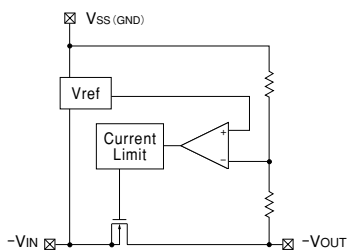

■Absolute Maximum Ratings

Ta=25°C

PARAMETER	SYMBOL	RATINGS	UNITS
Input Voltage	V _{IN}	-12	V
Output Current	I _{OUT}	200	mA
Output Voltage	V _{OUT}	-V _{DD} -0.3 ~ V _{IN} +0.3	V
Continuous Total Power Dissipation	P _d	SOT-23	150
		SOT-89	500
		TO-92	300
Operating Ambient Temperature	T _{opr}	-30 ~ +80	°C
Storage Temperature	T _{stg}	-40 ~ +125	°C

Note: Please ensure that I_{OUT} is less than P_d ÷ (V_{OUT} - V_{IN})

XC62K Series

Electrical Characteristics

XC62KN5002 $V_{OUT}(T)=-5.0V$ $T_a=25^{\circ}C$

PARAMETER	SYMBOL	CONDITIONS	MIN	TYP	MAX	UNITS
Output Voltage	$V_{OUT}(E)$	$I_{OUT}=20mA$ $V_{IN}=-6.0V$	$\times 0.98$ -4.90	$V_{OUT}(T)$ -5.0	$\times 1.02$ -5.10	V
Maximum Output Current	$I_{OUT\ max.}$	$V_{IN}=-6.0V, V_{OUT}(E) \geq -4.5V$	100			mA
Load Stability	ΔV_{OUT}	$V_{IN}=-6.0V$ $1mA \leq I_{OUT} \leq 50mA$		40	80	mV
Input/Output Voltage Differential	V_{dif}	$I_{OUT}=50mA$ $I_{OUT}=100mA$		120 380	300 600	mV
Supply Current	I_{SS}	$V_{IN}=-6.0V$		3.0	7.0	μA
Input Stability	$\frac{\Delta V_{OUT}}{\Delta V_{IN} \cdot V_{OUT}}$	$I_{OUT}=20mA$ $-6.0V \leq V_{IN} \leq -10.0V$		0.1	0.3	%/V
Input Voltage	V_{IN}				-10.0	V
Output Voltage Temperature Characteristics	$\frac{\Delta V_{OUT}}{\Delta T_{opr} \cdot V_{OUT}}$	$I_{OUT}=20mA$ $-30^{\circ}C \leq T_{opr} \leq 80^{\circ}C$		± 100		ppm/ $^{\circ}C$

XC62KN4002 $V_{OUT}(T)=-4.0V$ $T_a=25^{\circ}C$

PARAMETER	SYMBOL	CONDITIONS	MIN	TYP	MAX	UNITS
Output Voltage	$V_{OUT}(E)$	$I_{OUT}=20mA$ $V_{IN}=-5.0V$	$\times 0.98$ -3.92	$V_{OUT}(T)$ -4.0	$\times 1.02$ -4.08	V
Maximum Output Current	$I_{OUT\ max.}$	$V_{IN}=-5.0V, V_{OUT}(E) \geq -3.6V$	80			mA
Load Stability	ΔV_{OUT}	$V_{IN}=-5.0V$ $1mA \leq I_{OUT} \leq 45mA$		40	80	mV
Input/Output Voltage Differential	V_{dif}	$I_{OUT}=45mA$ $I_{OUT}=90mA$		120 380	300 600	mV
Supply Current	I_{SS}	$V_{IN}=-5.0V$		3.0	6.5	μA
Input Stability	$\frac{\Delta V_{OUT}}{\Delta V_{IN} \cdot V_{OUT}}$	$I_{OUT}=20mA$ $-5.0V \leq V_{IN} \leq -10.0V$		0.1	0.3	%/V
Input Voltage	V_{IN}				-10.0	V
Output Voltage Temperature Characteristics	$\frac{\Delta V_{OUT}}{\Delta T_{opr} \cdot V_{OUT}}$	$I_{OUT}=20mA$ $-30^{\circ}C \leq T_{opr} \leq 80^{\circ}C$		± 100		ppm/ $^{\circ}C$

- Note: 1. $V_{OUT}(T)$ =Specified output voltage
 2. $V_{OUT}(E)$ =Effective output voltage (i.e. the output voltage when " $V_{OUT}(T) - 1.0V$ " is provided at the V_{IN} pin while maintaining a certain I_{OUT} value).
 3. $V_{dif} = |V_{in1} - V_{out1}|$
 4. V_{out1} =A voltage equal to 98% of the Output Voltage whenever an amply stabilised I_{OUT} ($V_{OUT}(T) - 1.0V$) is input.
 5. V_{in1} =The Input Voltage when a voltage equal to 98% of $V_{OUT}(E)$ appears. (Input Voltage is gradually decreased.)
 6. $I_{OUT\ max}$ =Please ensure that output current is within the values given for power dissipation.

XC62K
Series

XC62KN3002 $V_{OUT}(T)=-3.0V$ Ta=25°C

PARAMETER	SYMBOL	CONDITIONS	MIN	TYP	MAX	UNITS
Output Voltage	$V_{OUT}(E)$	$I_{OUT}=20mA$ $V_{IN}=-4.0V$	$\times 0.98$ -2.94	$V_{OUT}(T)$ -3.0	$\times 1.02$ -3.06	V
Maximum Output Current	$I_{OUT\ max}$	$V_{IN}=-4.0V, V_{OUT}(E) \geq -2.7V$	60			mA
Load Stability	ΔV_{OUT}	$V_{IN}=-4.0V$ $1mA \leq I_{OUT} \leq 40mA$		40	80	mV
Input/Output Voltage Differential	V_{dif}	$I_{OUT}=40mA$ $I_{OUT}=80mA$		120 380	300 600	mV
Supply Current	I_{SS}	$V_{IN}=-4.0V$		2.5	6.0	μA
Input Stability	$\frac{\Delta V_{OUT}}{\Delta V_{IN} \cdot V_{OUT}}$	$I_{OUT}=20mA$ $-4.0V \leq V_{IN} \leq -10.0V$		0.1	0.3	%/V
Input Voltage	V_{IN}				-10.0	V
Output Voltage Temperature Characteristics	$\frac{\Delta V_{OUT}}{\Delta T_{opr} \cdot V_{OUT}}$	$I_{OUT}=20mA$ $-30^\circ C \leq T_{opr} \leq 80^\circ C$		± 100		ppm/°C

3

- Note:
1. $V_{OUT}(T)$ =Specified output voltage
 2. $V_{OUT}(E)$ =Effective output voltage (i.e. the output voltage when " $V_{OUT}(T) - 1.0V$ " is provided at the V_{IN} pin while maintaining a certain I_{OUT} value).
 3. $V_{dif} = (V_{IN1} - V_{OUT1})$
 4. V_{OUT1} =A voltage equal to 98% of the Output Voltage whenever an amply stabilised I_{OUT} ($V_{OUT}(T) - 1.0V$) is input.
 5. V_{IN1} =The Input Voltage when a voltage equal to 98% of $V_{OUT}(E)$ appears. (Input Voltage is gradually decreased.)
 6. $I_{OUT\ max}$ =Please ensure that output current is within the values given for power dissipation.

Typical Application Circuit

Standard Circuit

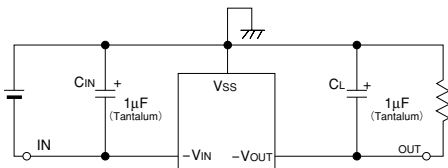

Directions for use

Notes on Use

Please ensure that values for C_{IN} and C_L are more than $1\mu F$ (Tantalum).

Test Circuits

1. Supply Current

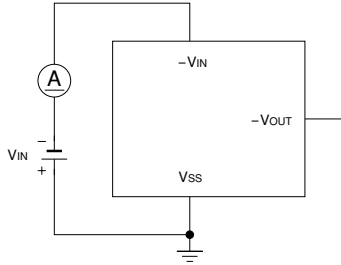

3

2. Output Voltage

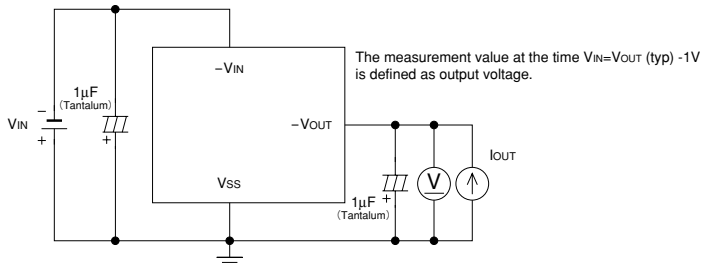

3. Input stability, Input/Output voltage differential

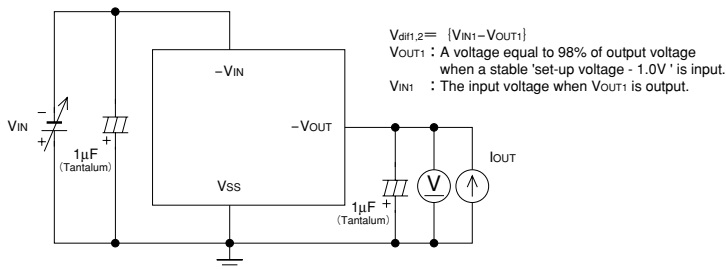

4. Load stability, Maximum output current

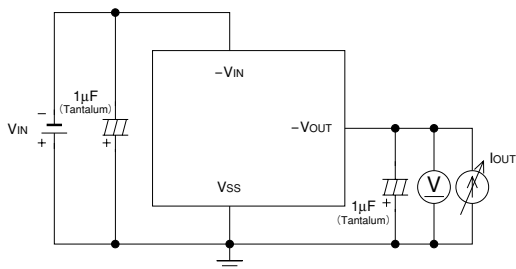

Typical Performance Characteristics

(1) OUTPUT VOLTAGE vs. OUTPUT CURRENT

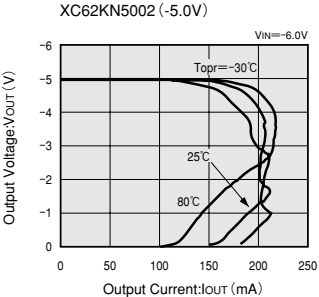
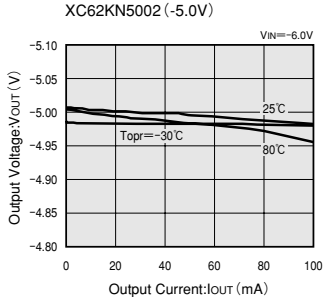

3

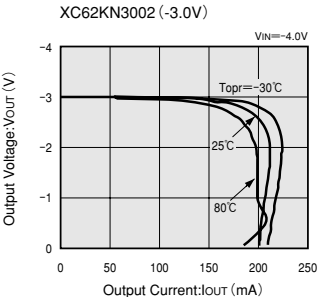
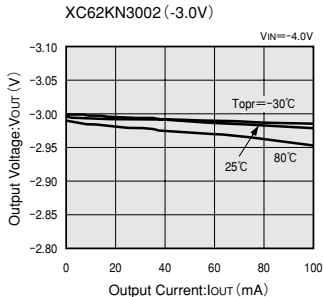
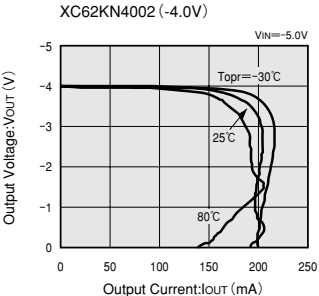
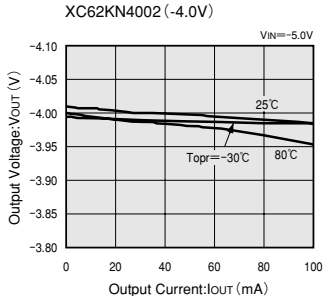

XC62K Series

(2) OUTPUT VOLTAGE vs. INPUT VOLTAGE

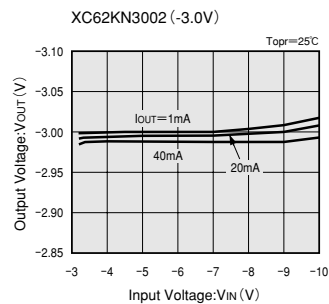
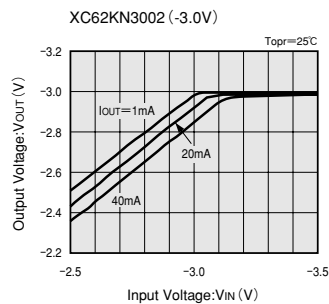
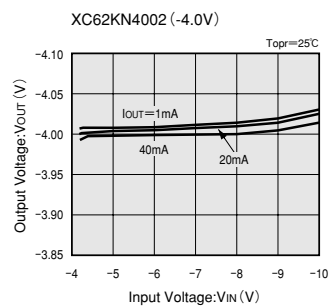
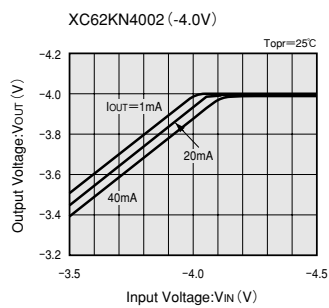
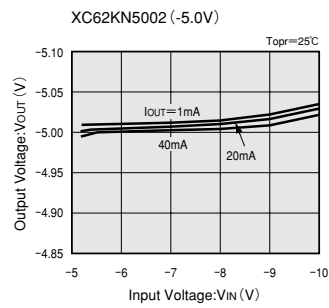
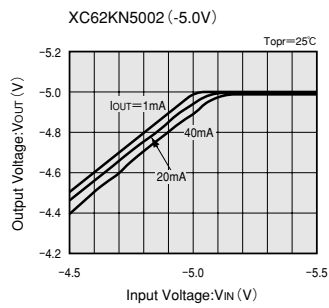

(3) INPUT/OUTPUT VOLTAGE DIFFERENTIAL vs. OUTPUT CURRENT

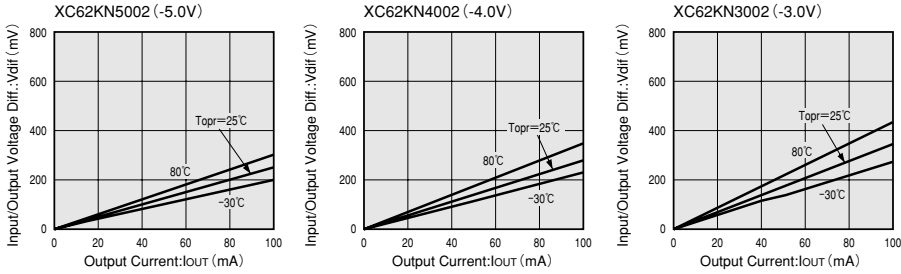

3

(4) SUPPLY CURRENT vs. INPUT VOLTAGE

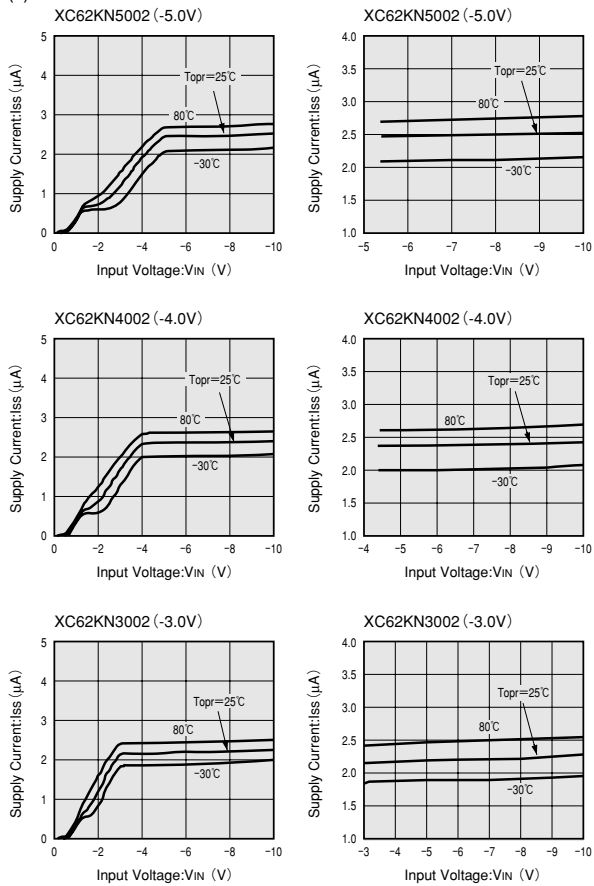

XC62K Series

3

(5) OUTPUT VOLTAGE vs. AMBIENT TEMPERATURE

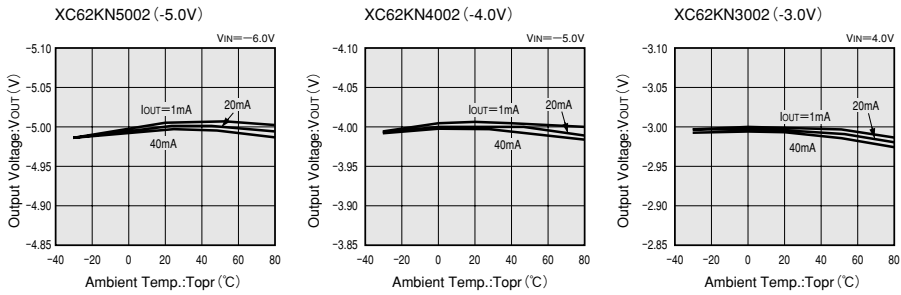

(6) SUPPLY CURRENT vs. AMBIENT TEMPERATURE

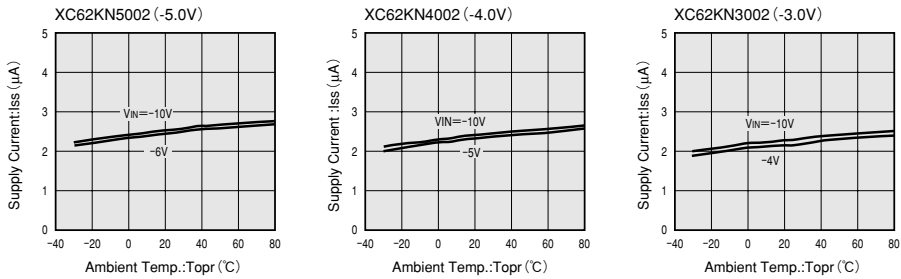

(7) INPUT TRANSIENT RESPONSE 1

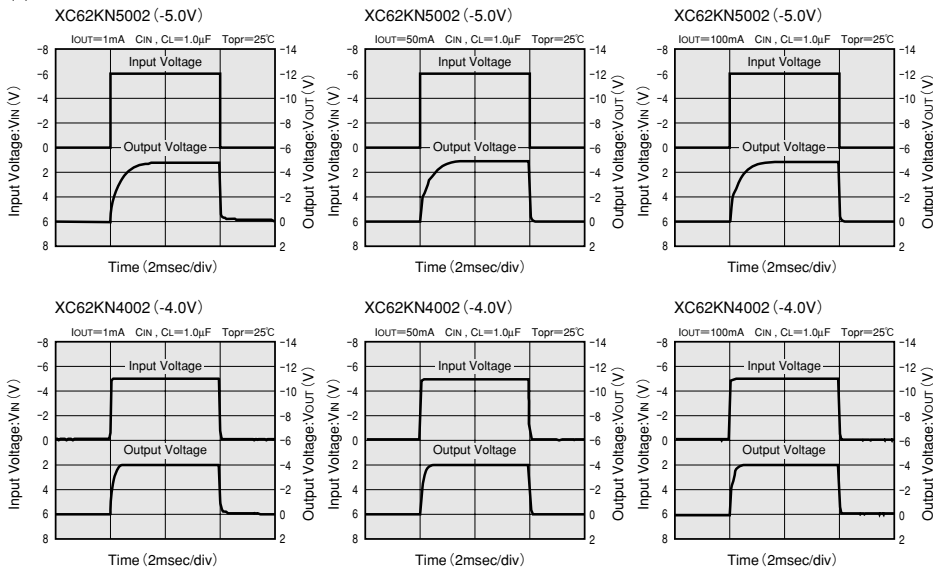

(7) INPUT TRANSIENT RESPONSE 1

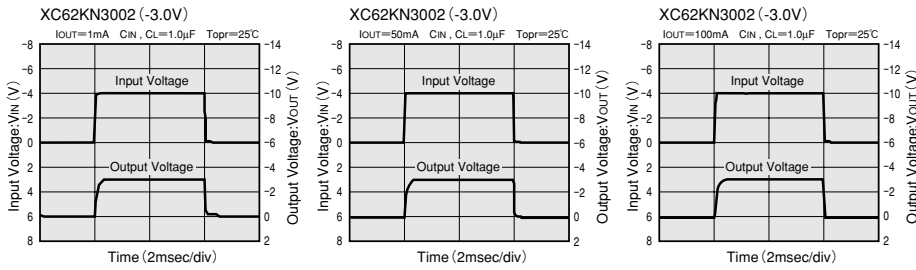

3

(8) INPUT TRANSIENT RESPONSE 2

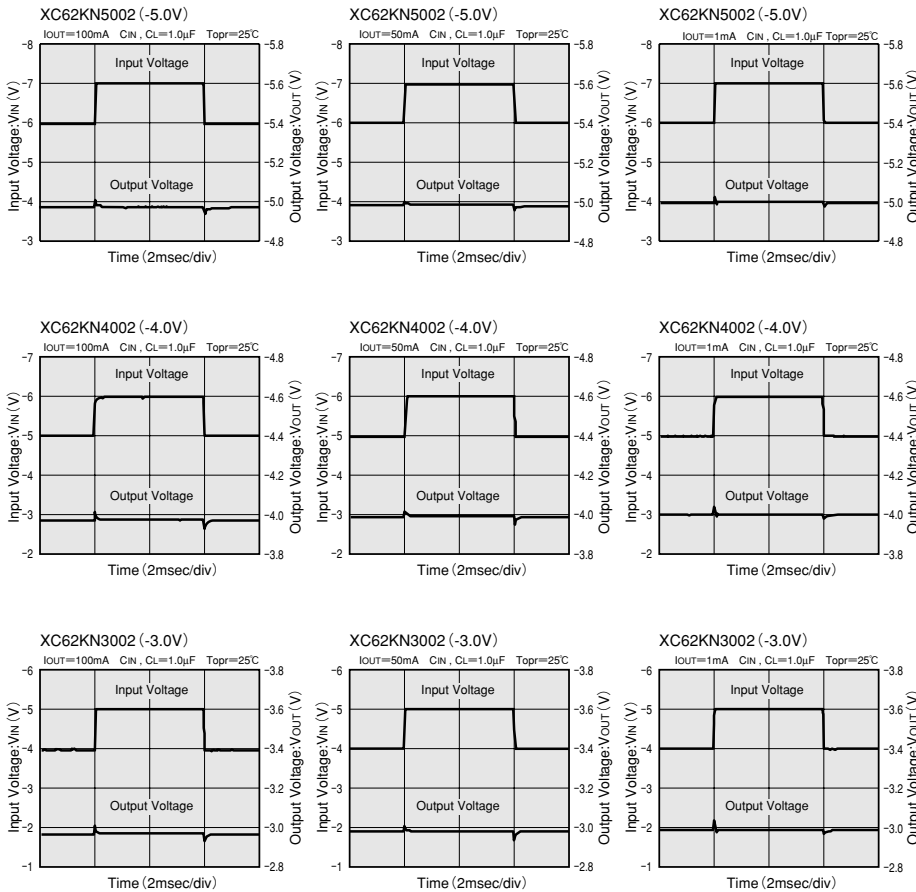

XC62K Series

3

(9) LOAD TRANSIENT RESPONSE

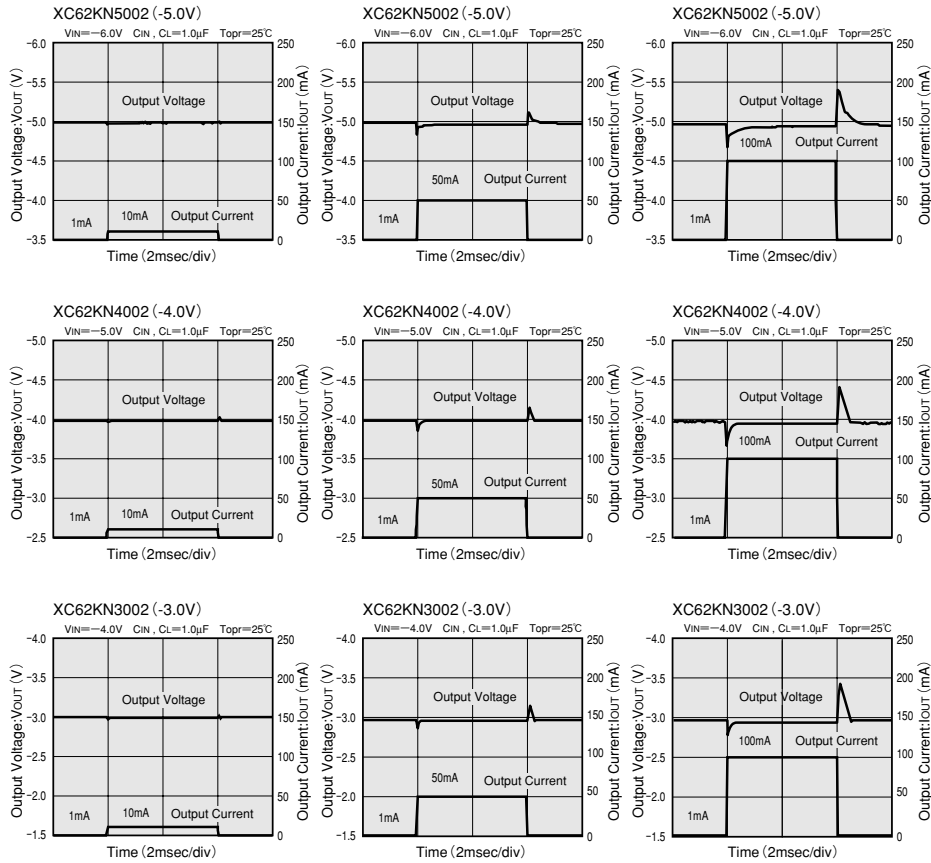

(10) RIPPLE REJECTION RATE

