



VERY LOW DROP AND LOW NOISE VOLTAGE REGULATOR WITH INHIBIT FUNCTION, LOW ESR CAP. COMPATIBLE

- VERY LOW DROPOUT VOLTAGE (120mV AT 50mA AND 7mV AT 1mA LOAD)
- VERY LOW QUIESCENT CURRENT (375 μ A TYP. AT 50mA LOAD AND 75 μ A AT 1mA)
- OUTPUT CURRENT UP TO 50mA
- LOGIC CONTROLLED ELECTRONIC SHUTDOWN
- OUTPUT VOLTAGE OF 1.5, 1.8, 2.5, 2.8, 2.85, 3, 3.1, 3.2, 3.3, 3.5, 3.6, 3.8, 4, 4.7, 5V
- INTERNAL CURRENT AND THERMAL LIMIT
- AVAILABLE IN $\pm 1\%$ TOLLERANCE (AT 25°C, A VERSION)
- SUPPLY VOLTAGE REJECTION: 45dB (TYP)
- ONLY 1 μ F FOR STABILITY
- LOW OUTPUT NOISE VOLTAGE 30 μ Vrms
- SMALLEST PACKAGE SOT23-5L
- TEMPERATURE RANGE: -40°C TO 125°C

DESCRIPTION

The LD2982 is a 50mA fixed output voltage regulator. The ultra low drop voltage and the low quiescent current make them particularly suitable for low noise, low power applications, and in battery powered systems. In sleep mode quiescent current is less than 1 μ A when INHIBIT

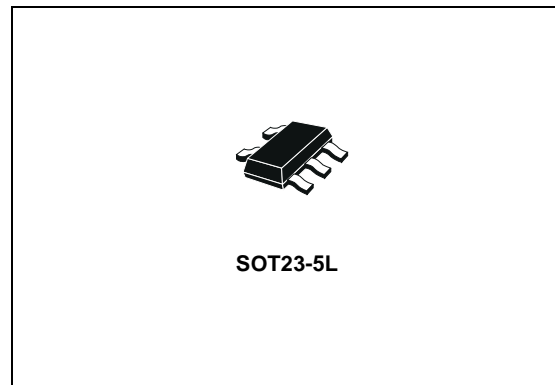

pin is pulled low. Shutdown Logic Control Function is available on pin 3 (TTL compatible). This means that when the device is used as local regulator, it is possible to put a part of the board in standby, decreasing the total power consumption.

An external capacitor $C_{BYP}=10nF$ connected between bypass pin and GND reduce the noise to 30 μ Vrms.

Typical application are in cellular phone, palmtop/laptop computer, personal digital assistant (PDA), personal stereo, camcorder and camera.

SCHEMATIC DIAGRAM

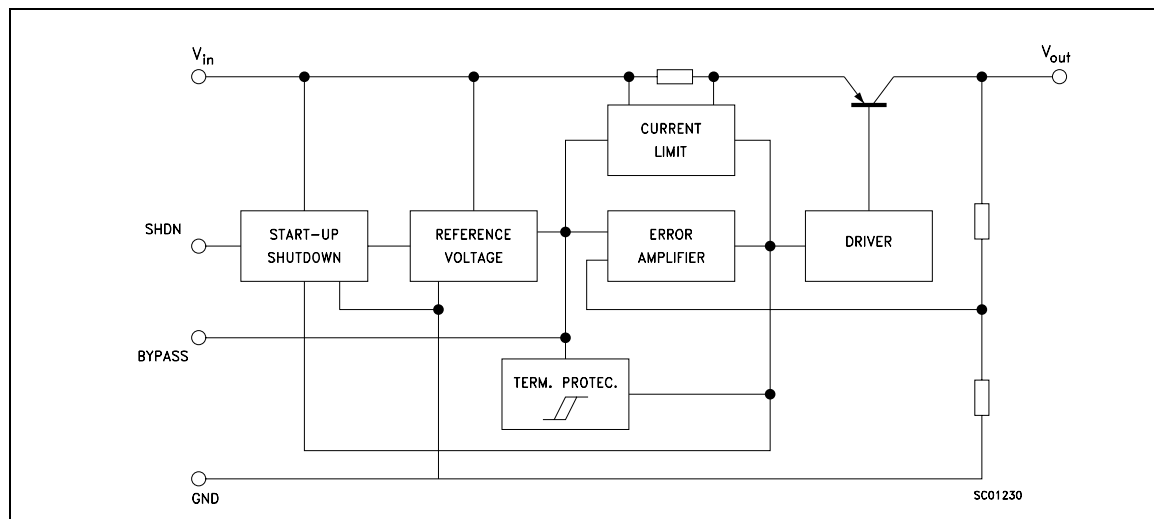

LD2982 SERIES

ABSOLUTE MAXIMUM RATINGS

Symbol	Parameter	Value	Unit
V_I	DC Input Voltage	16	V
V_{INH}	INHIBIT Input Voltage	16	V
I_O	Output Current	Internally limited	
P_{tot}	Power Dissipation	Internally limited	
T_{stg}	Storage Temperature Range	-65 to +150	°C
T_{op}	Operating Junction Temperature Range	-40 to +125	°C

Absolute Maximum Ratings are those values beyond which damage to the device may occur. Functional operation under these condition is not implied.

THERMAL DATA

Symbol	Parameter	SOT23-5L	Unit
$R_{thj-case}$	Thermal Resistance Junction-case	81	°C/W

CONNECTION DIAGRAM (top view)

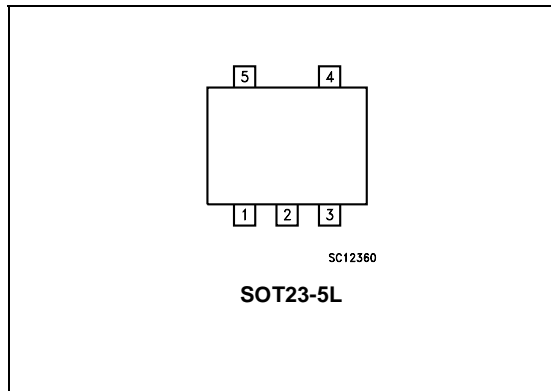

PIN DESCRIPTION

Pin N°	Symbol	Name and Function
1	IN	Input Port
2	GND	Ground Pin
3	INHIBIT	Control switch ON/OFF. Inhibit is not internally pulled-up; it cannot be left floating. Disable the device when connected to GND or to a positive voltage less than 0.18V
4	Bypass	Bypass Pin: Capacitor to be connected to GND in order to improve the thermal noise performances.
5	OUT	Output Port

ORDERING CODES

A VERSION	B VERSION	OUTPUT VOLTAGES
LD2982AM15R	LD2982BM15R	1.5V
LD2982AM18R	LD2982BM18R	1.8V
LD2982AM25R	LD2982BM25R	2.5V
LD2982AM28R	LD2982BM28R	2.8V
LD2982AM285R	LD2982BM285R	2.85V
LD2982AM30R	LD2982BM30R	3.0V
LD2982AM31R	LD2982BM31R	3.1V
LD2982AM32R	LD2982BM32R	3.2V
LD2982AM33R	LD2982BM33R	3.3V
LD2982AM35R	LD2982BM35R	3.5V
LD2982AM36R	LD2982BM36R	3.6V
LD2982AM38R	LD2982BM38R	3.8V
LD2982AM40R	LD2982BM40R	4.0V
LD2982AM47R	LD2982BM47R	4.7V
LD2982AM50R	LD2982BM50R	5.0V

ELECTRICAL CHARACTERISTICS FOR LD2982A ($T_J = 25^\circ\text{C}$, $V_I = V_O + 1\text{V}$, $I_O = 1\text{mA}$, $V_{\text{SHDN}} = 2\text{V}$, $C_I = 1\mu\text{F}$, $C_O = 1\mu\text{F}$, unless otherwise specified)

Symbol	Parameter	Test Conditions	Min.	Typ.	Max.	Unit
V_{Op}	Operating Input Voltage		2.5		16	V
V_O	Output Voltage	$V_I = 2.5\text{V}$	1.485	1.5	1.515	V
		$I_O = 1$ to 50mA	1.477		1.523	V
		$I_O = 1$ to 50mA $T_J = -40$ to 125°C	1.470		1.530	V
V_O	Output Voltage	$V_I = 2.8\text{V}$	1.782	1.8	1.818	V
		$I_O = 1$ to 50mA	1.773		1.827	V
		$I_O = 1$ to 50mA $T_J = -40$ to 125°C	1.764		1.836	V
V_O	Output Voltage	$V_I = 3.5\text{V}$	2.475	2.5	2.525	V
		$I_O = 1$ to 50mA	2.462		2.537	V
		$I_O = 1$ to 50mA $T_J = -40$ to 125°C	2.45		2.55	V
V_O	Output Voltage	$V_I = 3.8\text{V}$	2.772	2.8	2.828	V
		$I_O = 1$ to 50mA	2.758		2.842	V
		$I_O = 1$ to 50mA $T_J = -40$ to 125°C	2.744		2.856	V
V_O	Output Voltage	$V_I = 3.85\text{V}$	2.821	2.85	2.879	V
		$I_O = 1$ to 50mA	2.807		2.893	V
		$I_O = 1$ to 50mA $T_J = -40$ to 125°C	2.793		2.907	V
V_O	Output Voltage	$V_I = 4.0\text{V}$	2.970	3.0	3.030	V
		$I_O = 1$ to 50mA	2.955		3.045	V
		$I_O = 1$ to 50mA $T_J = -40$ to 125°C	2.94		3.06	V
V_O	Output Voltage	$V_I = 4.1\text{V}$	3.069	3.1	3.131	V
		$I_O = 1$ to 50mA	3.053		3.146	V
		$I_O = 1$ to 50mA $T_J = -40$ to 125°C	3.038		3.162	V
V_O	Output Voltage	$V_I = 4.2\text{V}$	3.168	3.2	3.232	V
		$I_O = 1$ to 50mA	3.152		3.248	V
		$I_O = 1$ to 50mA $T_J = -40$ to 125°C	3.136		3.264	V
V_O	Output Voltage	$V_I = 4.3\text{V}$	3.267	3.3	3.333	V
		$I_O = 1$ to 50mA	3.250		3.349	V
		$I_O = 1$ to 50mA $T_J = -40$ to 125°C	3.234		3.366	V
V_O	Output Voltage	$V_I = 4.5\text{V}$	3.465	3.5	3.535	V
		$I_O = 1$ to 50mA	3.447		3.552	V
		$I_O = 1$ to 50mA $T_J = -40$ to 125°C	3.43		3.57	V
V_O	Output Voltage	$V_I = 4.6\text{V}$	3.564	3.6	3.636	V
		$I_O = 1$ to 50mA	3.546		3.654	V
		$I_O = 1$ to 50mA $T_J = -40$ to 125°C	3.528		3.672	V
V_O	Output Voltage	$V_I = 4.8\text{V}$	3.762	3.8	3.838	V
		$I_O = 1$ to 50mA	3.743		3.857	V
		$I_O = 1$ to 50mA $T_J = -40$ to 125°C	3.724		3.876	V
V_O	Output Voltage	$V_I = 5.0\text{V}$	3.96	4	4.04	V
		$I_O = 1$ to 50mA	3.94		4.06	V
		$I_O = 1$ to 50mA $T_J = -40$ to 125°C	3.92		4.08	V

LD2982 SERIES

Symbol	Parameter	Test Conditions	Min.	Typ.	Max.	Unit
V _O	Output Voltage	V _I = 5.7V	4.653	4.7	4.747	V
		I _O = 1 to 50mA	4.629		4.77	V
		I _O = 1 to 50mA T _J = -40 to 125°C	4.606		4.794	V
V _O	Output Voltage	V _I = 6.0V	4.95	5	5.05	V
		I _O = 1 to 50mA	4.925		5.075	V
		I _O = 1 to 50mA T _J = -40 to 125°C	4.9		5.1	V
I _{SC}	Short Circuit Current	R _L = 0		150		mA
ΔV _O /ΔV _I	Line Regulation	V _I = V _O +1V to 16V, I _O = 1mA		0.003	0.014	%/V _I
		V _I = V _O +1V to 16V, I _O = 1mA T _J = -40 to 125°C			0.032	%/V _I
V _d	Dropout Voltage	I _O = 0		1	3	mV
		I _O = 0 T _J = -40 to 125°C			5	mV
		I _O = 1mA		7	10	mV
		I _O = 1mA T _J = -40 to 125°C			15	mV
		I _O = 10mA		40	60	mV
		I _O = 10mA T _J = -40 to 125°C			90	mV
		I _O = 50mA		120	150	mV
		I _O = 50mA T _J = -40 to 125°C			225	mV
I _d	Quiescent Current	I _O = 0		80	100	μA
		I _O = 0 T _J = -40 to 125°C			150	μA
		I _O = 1mA		100	150	μA
		I _O = 1mA T _J = -40 to 125°C			200	μA
		I _O = 10mA		200	300	μA
		I _O = 10mA T _J = -40 to 125°C			400	μA
		I _O = 50mA		600	900	μA
		I _O = 50mA T _J = -40 to 125°C			1200	μA
		OFF MODE V _{INH} < 0.18V		0		μA
		OFF MODE V _{INH} < 0.18V T _J = -40 to 125°C			1	μA
SVR	Supply Voltage Rejection	C _{BYP} = 0.01μF C _O = 10μF f = 1KHz		45		dB
V _{IL}	Control Input Logic Low	T _J = -40 to 125°C			0.15	V
V _{IH}	Control Input Logic High	T _J = -40 to 125°C	2			V
I _{iNH}	Control Input Current	T _J = -40 to 125°C V _{SHDN} = 5V		5	15	μA
		T _J = -40 to 125°C V _{SHDN} = 0V		0	-1	μA
eN	Output Noise Voltage	B = 300Hz to 50KHz C _{BYP} = 0.01μF C _O = 10μF		30		μV

ELECTRICAL CHARACTERISTICS FOR LD2982B ($T_J = 25^\circ\text{C}$, $V_I = V_O + 1\text{V}$, $I_O = 1\text{mA}$, $V_{\text{SHDN}} = 2\text{V}$, $C_I = 1\mu\text{F}$, $C_O = 1\mu\text{F}$, unless otherwise specified)

Symbol	Parameter	Test Conditions	Min.	Typ.	Max.	Unit
V_{Op}	Operating Input Voltage		2.5		16	V
V_O	Output Voltage	$V_I = 2.5\text{V}$	1.477	1.5	1.523	V
		$I_O = 1$ to 50mA	1.470		1.530	V
		$I_O = 1$ to 50mA $T_J = -40$ to 125°C	1.447		1.553	V
V_O	Output Voltage	$V_I = 2.8\text{V}$	1.773	1.8	1.827	V
		$I_O = 1$ to 50mA	1.764		1.836	V
		$I_O = 1$ to 50mA $T_J = -40$ to 125°C	1.737		1.863	V
V_O	Output Voltage	$V_I = 3.5\text{V}$	2.462	2.5	2.537	V
		$I_O = 1$ to 50mA	2.45		2.55	V
		$I_O = 1$ to 50mA $T_J = -40$ to 125°C	2.412		2.587	V
V_O	Output Voltage	$V_I = 3.8\text{V}$	2.758	2.8	2.842	V
		$I_O = 1$ to 50mA	2.744		2.856	V
		$I_O = 1$ to 50mA $T_J = -40$ to 125°C	2.702		2.898	V
V_O	Output Voltage	$V_I = 3.85\text{V}$	2.807	2.85	2.893	V
		$I_O = 1$ to 50mA	2.793		2.907	V
		$I_O = 1$ to 50mA $T_J = -40$ to 125°C	2.750		2.950	V
V_O	Output Voltage	$V_I = 4.0\text{V}$	2.955	3.0	3.045	V
		$I_O = 1$ to 50mA	2.94		3.06	V
		$I_O = 1$ to 50mA $T_J = -40$ to 125°C	2.895		3.105	V
V_O	Output Voltage	$V_I = 4.1\text{V}$	3.053	3.1	3.146	V
		$I_O = 1$ to 50mA	3.038		3.162	V
		$I_O = 1$ to 50mA $T_J = -40$ to 125°C	2.991		3.208	V
V_O	Output Voltage	$V_I = 4.2\text{V}$	3.152	3.2	3.248	V
		$I_O = 1$ to 50mA	3.136		3.264	V
		$I_O = 1$ to 50mA $T_J = -40$ to 125°C	3.088		3.312	V
V_O	Output Voltage	$V_I = 4.3\text{V}$	3.250	3.3	3.349	V
		$I_O = 1$ to 50mA	3.234		3.366	V
		$I_O = 1$ to 50mA $T_J = -40$ to 125°C	3.184		3.415	V
V_O	Output Voltage	$V_I = 4.5\text{V}$	3.447	3.5	3.552	V
		$I_O = 1$ to 50mA	3.430		3.370	V
		$I_O = 1$ to 50mA $T_J = -40$ to 125°C	3.377		3.662	V
V_O	Output Voltage	$V_I = 4.6\text{V}$	3.546	3.6	3.654	V
		$I_O = 1$ to 50mA	3.528		3.672	V
		$I_O = 1$ to 50mA $T_J = -40$ to 125°C	3.474		3.726	V
V_O	Output Voltage	$V_I = 4.8\text{V}$	3.743	3.8	3.857	V
		$I_O = 1$ to 50mA	3.724		3.876	V
		$I_O = 1$ to 50mA $T_J = -40$ to 125°C	3.667		3.933	V
V_O	Output Voltage	$V_I = 5.0\text{V}$	3.94	4	4.06	V
		$I_O = 1$ to 50mA	3.92		4.08	V
		$I_O = 1$ to 50mA $T_J = -40$ to 125°C	3.86		4.14	V

LD2982 SERIES

Symbol	Parameter	Test Conditions	Min.	Typ.	Max.	Unit
V _O	Output Voltage	V _I = 5.7V	4.629	4.7	4.77	V
		I _O = 1 to 50mA	4.606		4.794	V
		I _O = 1 to 50mA T _J = -40 to 125°C	4.535		4.864	V
V _O	Output Voltage	V _I = 6.0V	4.925	5	5.075	V
		I _O = 1 to 50mA	4.9		5.1	V
		I _O = 1 to 50mA T _J = -40 to 125°C	4.825		5.175	V
I _{SC}	Short Circuit Current	R _L = 0		400		mA
ΔV _O /ΔV _I	Line Regulation	V _I = V _O +1V to 16V, I _O = 1mA		0.003	0.014	%/V _I
		V _I = V _O +1V to 16V, I _O = 1mA T _J = -40 to 125°C			0.032	%/V _I
V _d	Dropout Voltage	I _O = 0		1	3	mV
		I _O = 0 T _J = -40 to 125°C			5	mV
		I _O = 1mA		7	10	mV
		I _O = 1mA T _J = -40 to 125°C			15	mV
		I _O = 10mA		40	60	mV
		I _O = 10mA T _J = -40 to 125°C			90	mV
		I _O = 50mA		120	150	mV
		I _O = 50mA T _J = -40 to 125°C			225	mV
I _d	Quiescent Current	I _O = 0		80	100	μA
		I _O = 0 T _J = -40 to 125°C			150	μA
		I _O = 1mA		100	150	μA
		I _O = 1mA T _J = -40 to 125°C			200	μA
		I _O = 10mA		200	300	μA
		I _O = 10mA T _J = -40 to 125°C			400	μA
		I _O = 50mA		600	900	μA
		I _O = 50mA T _J = -40 to 125°C			1200	μA
		OFF MODE V _{INH} < 0.18V		0		μA
		OFF MODE V _{INH} < 0.18V T _J = -40 to 125°C			1	μA
SVR	Supply Voltage Rejection	C _{BYP} = 0.01μF C _O = 10μF f = 1KHz		45		dB
V _{IL}	Control Input Logic Low	T _J = -40 to 125°C			0.15	V
V _{IH}	Control Input Logic High	T _J = -40 to 125°C	2			V
I _{iNH}	Control Input Current	T _J = -40 to 125°C V _{SHDN} = 5V		5	15	μA
		T _J = -40 to 125°C V _{SHDN} = 0V		0	-1	μA
eN	Output Noise Voltage	B = 300Hz to 50KHz C _{BYP} = 0.01μF C _O = 10μF		30		μV

TYPICAL CHARACTERISTICS (unless otherwise specified $T_J = 25^\circ\text{C}$, $C_I = 1\mu\text{F}$, $C_O = 2.2\mu\text{F}$, $C_{BYP} = 100\text{nF}$)

Figure 1 : Output Voltage vs Temperature

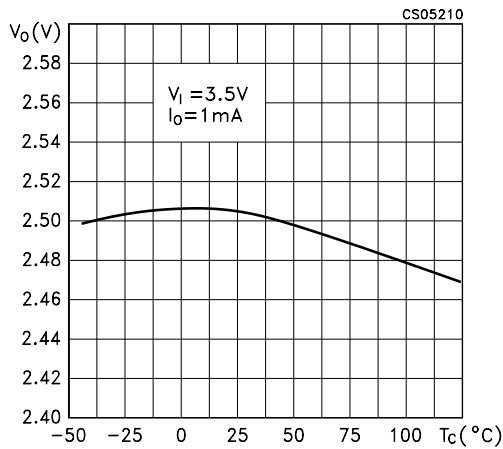

Figure 2 : Dropout Voltage vs Temperature

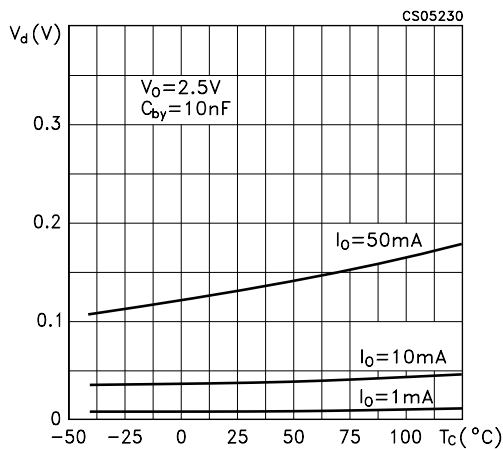

Figure 3 : Dropout Voltage vs Output Current

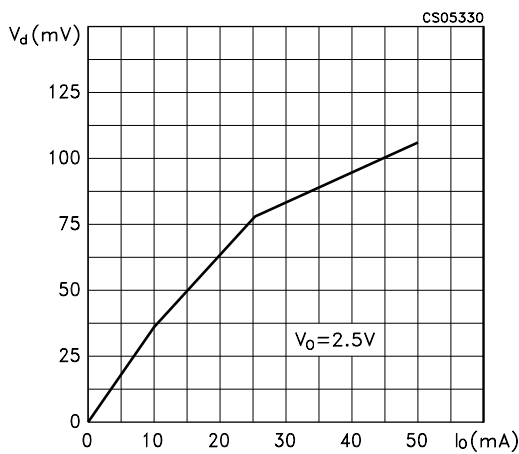

Figure 4 : Quiescent Current vs Load Current

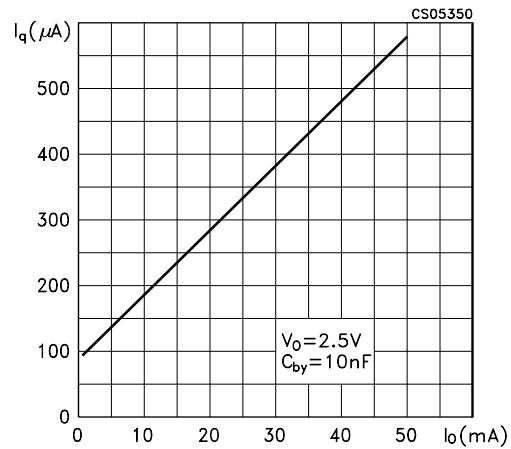

Figure 5 : Quiescent Current vs Temperature

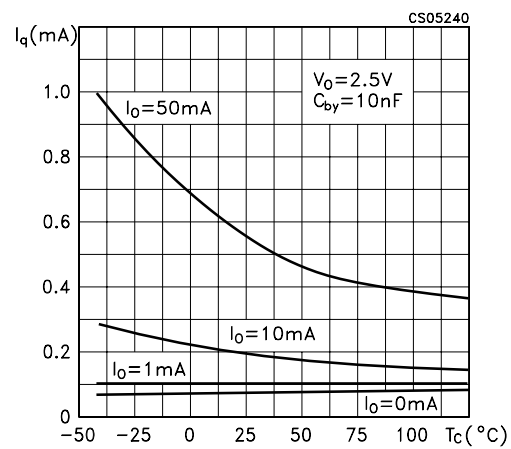

Figure 6 : Supply Voltage Rejection vs Temperature

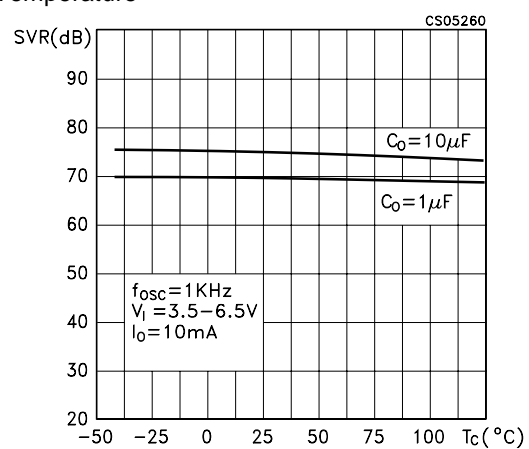

Figure 7 : Supply Voltage Rejection vs Output Current

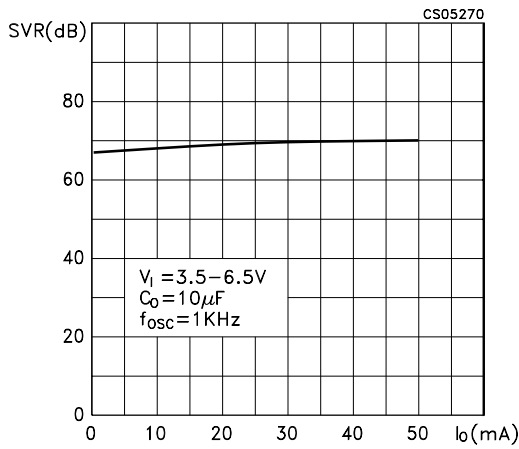

Figure 10 : Supply Voltage Rejection vs Frequency

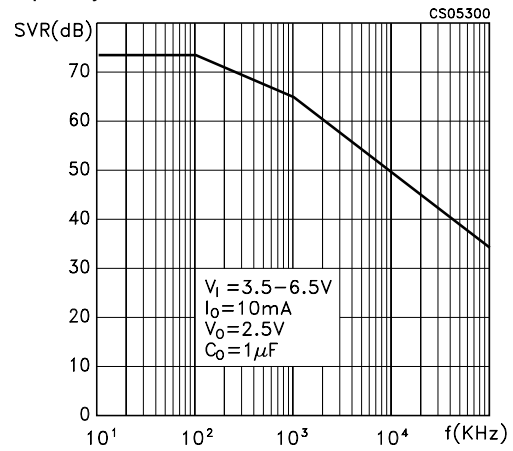

Figure 8 : Supply Voltage Rejection vs Output Current

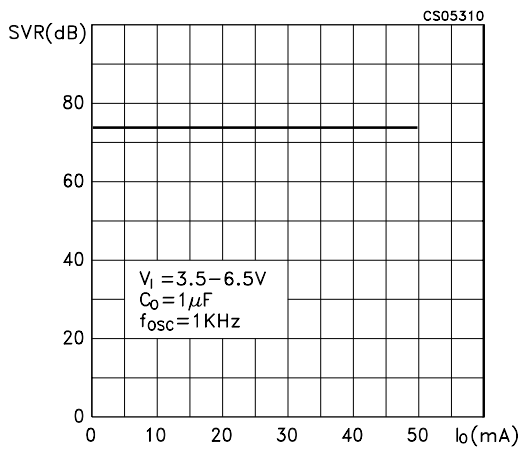

Figure 11 : Line Transient

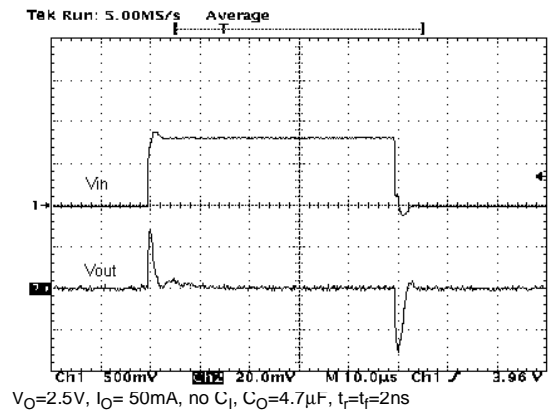

Figure 9 : Supply Voltage Rejection vs Frequency

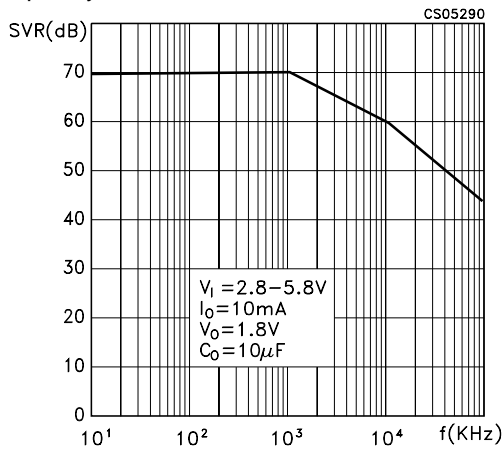

Figure 12 : Line Transient

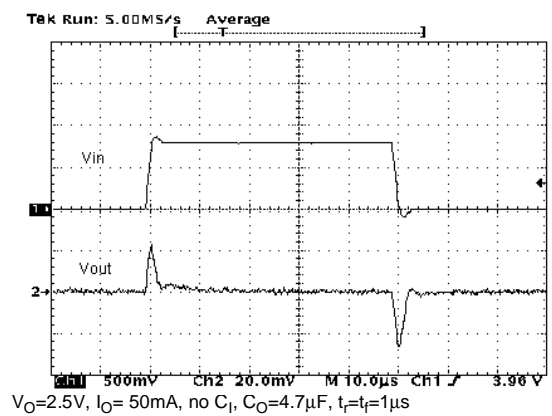

Figure 13 : Load Transient

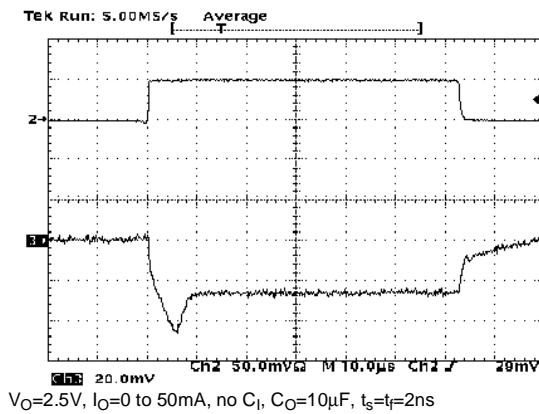
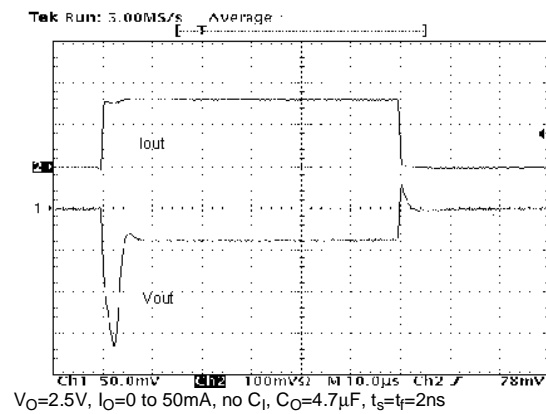

Figure 14 : Load Transient



EXTERNAL CAPACITORS

Like any low-dropout regulator, the LD2982 requires external capacitors for regulator stability. This capacitor must be selected to meet the requirements of minimum capacitance and equivalent series resistance. We suggest to solder input and output capacitors as close as possible to the relative pins.

INPUT CAPACITOR

An input capacitor whose value is $1\mu F$ is required with the LD2982 (amount of capacitance can be increased without limit). This capacitor must be located a distance of not more than 0.5" from the input pin of the device and returned to a clean analog ground. Any good quality ceramic, tantalum or film capacitors can be used for this capacitor.

OUTPUT CAPACITOR

The LD2982 is designed specifically to work with ceramic output capacitors. It may also be possible to use Tantalum capacitors, but these are not as attractive for reasons of size and cost. By the way, the output capacitor must meet both the requirement for minimum amount of capacitance and E.S.R. (equivalent series resistance) value. Due to the different loop gain, the stability improves for higher output versions and so the suggested minimum output capacitor value, if low E.S.R. ceramic type is used, is $1\mu F$ for output voltages equal or major than 3.8V, $2.2\mu F$ for V_O going from 1.8 to 3.3V, and $3.3\mu F$ for the other versions. However, if an output capacitor lower than the suggested one is used, it's possible to make stable the regulator adding a resistor in series to the capacitor.

IMPORTANT:

The output capacitor must maintain its ESR in the stable region over the full operating temperature to assure stability. Also, capacitor tolerance and variation with temperature must be considered to assure the minimum amount of capacitance is provided at all times. This capacitor should be located not more than 0.5" from the output pin of the device and returned to a clean analog ground.

INHIBIT INPUT OPERATION

The inhibit pin can be used to turn OFF the regulator when pulled low, so drastically reducing the current consumption down to less than $1\mu A$. When the inhibit feature is not used, this pin must be tied to V_I to keep the regulator output ON at all times. To assure proper operation, the signal source used to drive the inhibit pin must be able to swing above and below the specified thresholds listed in the electrical characteristics section under V_{IH} V_{IL} . Any slew rate can be used to drive the inhibit.

LD2982 SERIES

REVERSE CURRENT

The power transistor used in the LD2982 has not an inherent diode connected between the regulator input and output. If the output is forced above the input, no current will flow from the output to the input across the series pass transistor. When a V_{REV} voltage is applied on the output, the reverse current measured flows to the GND across the two feedback resistors. This current typical value is $160\mu\text{A}$. R_1 and R_2 resistors are implanted type; typical values are, respectively, $42.6\text{ K}\Omega$ and $51.150\text{ K}\Omega$.

Figure 15 : Reverse Current Test Circuit

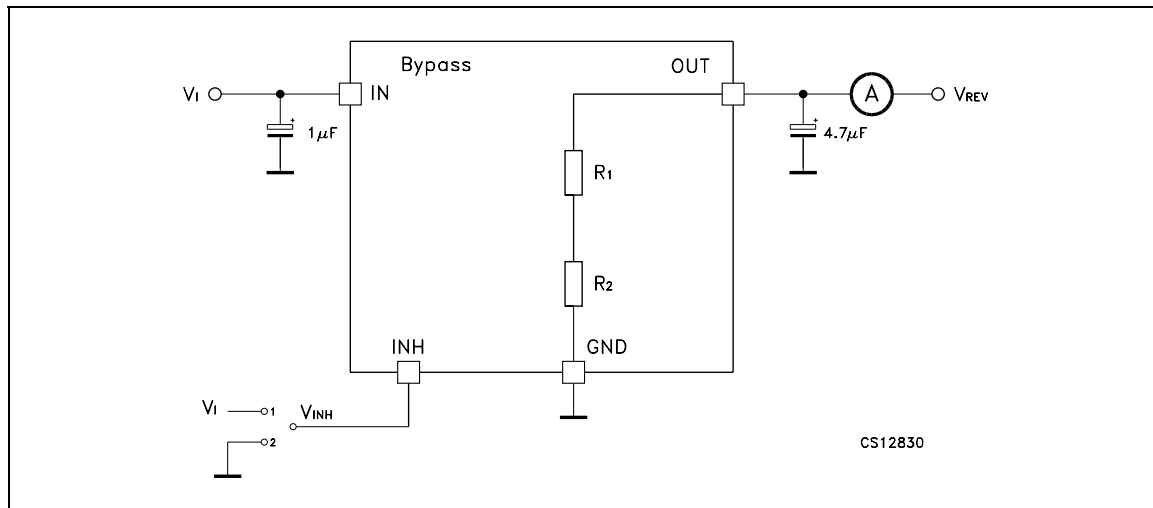

SOT23-5L MECHANICAL DATA

DIM.	mm.			mils		
	MIN.	TYP	MAX.	MIN.	TYP.	MAX.
A	0.90		1.45	35.4		57.1
A1	0.00		0.10	0.0		3.9
A2	0.90		1.30	35.4		51.2
b	0.35		0.50	13.7		19.7
C	0.09		0.20	3.5		7.8
D	2.80		3.00	110.2		118.1
E	1.50		1.75	59.0		68.8
e		0.95			37.4	
H	2.60		3.00	102.3		118.1
L	0.10		0.60	3.9		23.6

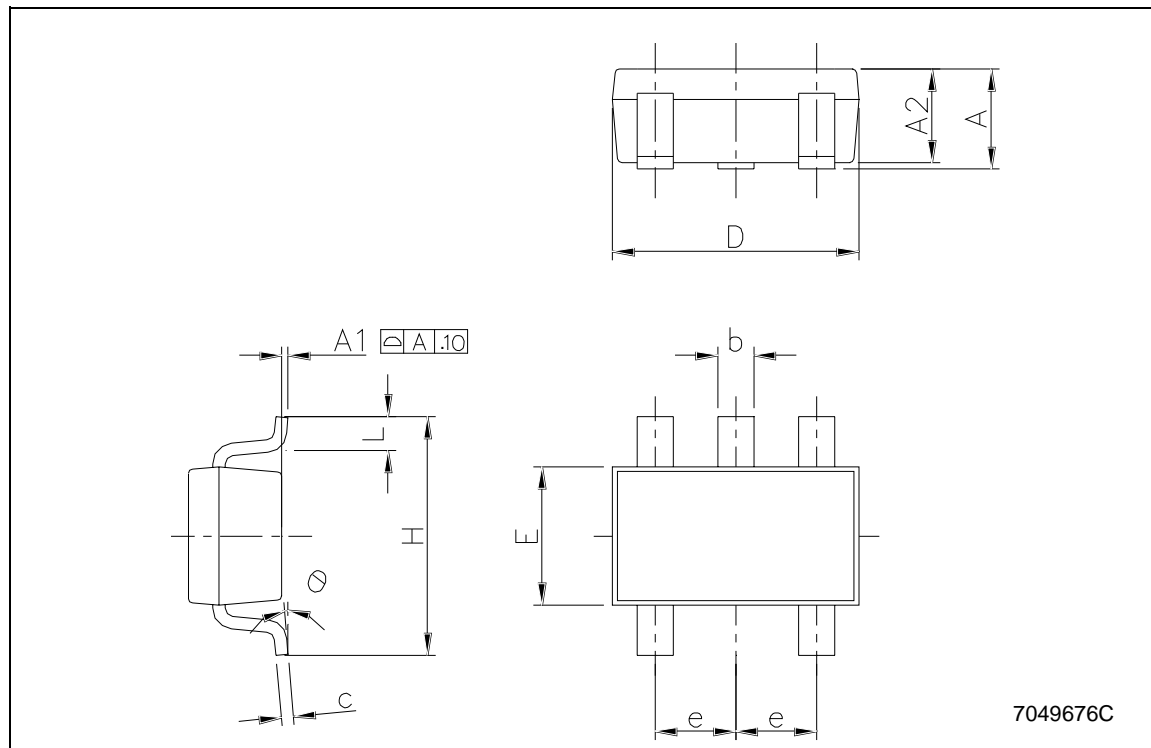

Tape & Reel SOT23-xL MECHANICAL DATA

DIM.	mm.			inch		
	MIN.	TYP	MAX.	MIN.	TYP.	MAX.
A			180			7.086
C	12.8	13.0	13.2	0.504	0.512	0.519
D	20.2			0.795		
N	60			2.362		
T			14.4			0.567
Ao	3.13	3.23	3.33	0.123	0.127	0.131
Bo	3.07	3.17	3.27	0.120	0.124	0.128
Ko	1.27	1.37	1.47	0.050	0.054	0.058
Po	3.9	4.0	4.1	0.153	0.157	0.161
P	3.9	4.0	4.1	0.153	0.157	0.161

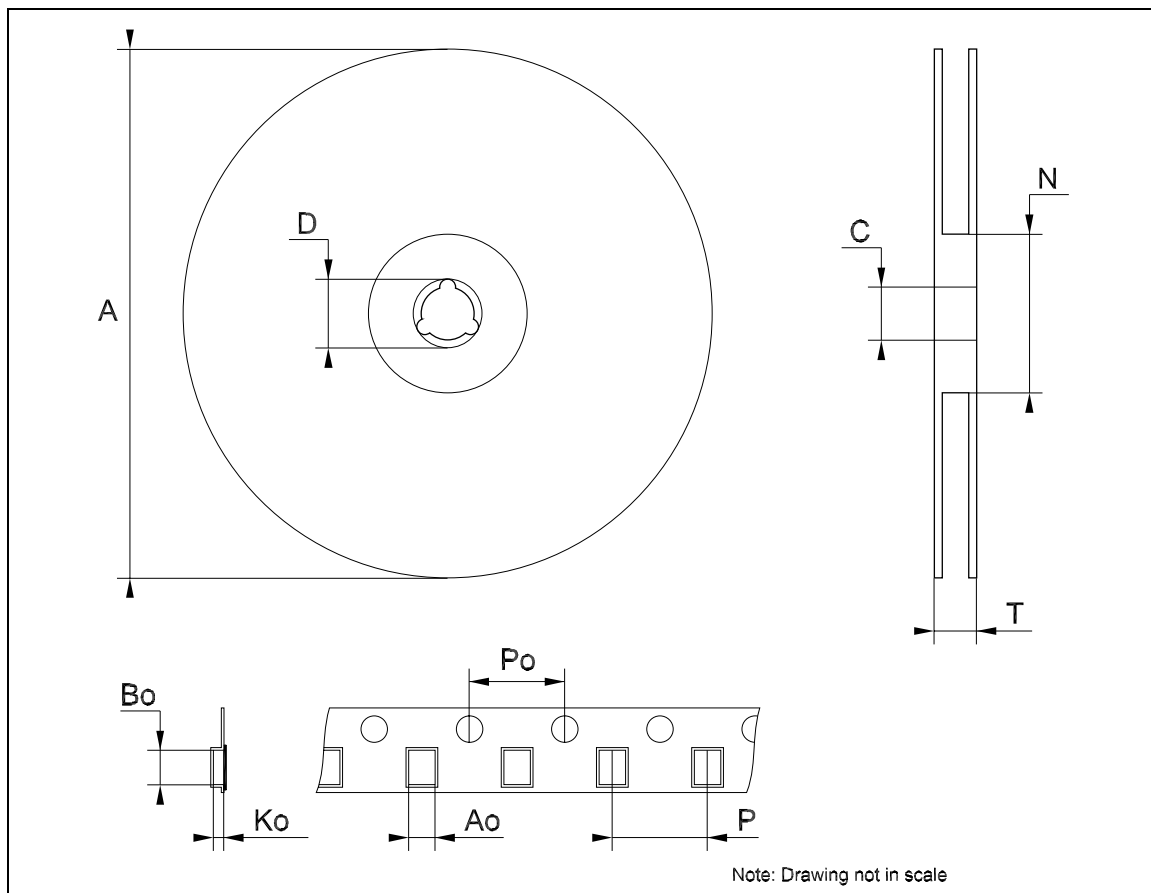

Information furnished is believed to be accurate and reliable. However, STMicroelectronics assumes no responsibility for the consequences of use of such information nor for any infringement of patents or other rights of third parties which may result from its use. No license is granted by implication or otherwise under any patent or patent rights of STMicroelectronics. Specifications mentioned in this publication are subject to change without notice. This publication supersedes and replaces all information previously supplied. STMicroelectronics products are not authorized for use as critical components in life support devices or systems without express written approval of STMicroelectronics.

© The ST logo is a registered trademark of STMicroelectronics

© 2003 STMicroelectronics - Printed in Italy - All Rights Reserved
STMicroelectronics GROUP OF COMPANIES

Australia - Brazil - Canada - China - Finland - France - Germany - Hong Kong - India - Israel - Italy - Japan - Malaysia - Malta - Morocco
Singapore - Spain - Sweden - Switzerland - United Kingdom - United States.

© <http://www.st.com>

