

## TA76432FT, TA76432FC, TA76432F, TA76432FR, TA76432S

### 1.26-V Adjustable High-Precision Shunt Regulators

These devices are adjustable high-precision shunt regulators whose output voltage ( $V_{KA}$ ) can be set arbitrarily using two external resistors.

These devices have a precise internal reference voltage of 1.26 V, enabling them to operate at low voltage.

These devices are ideal for use as error amplifiers in 3-V switching-regulator systems. In addition, they can be used as zener diodes to perform temperature compensation.

#### Features

- Precision reference voltage:  $V_{REF} = 1.26 \text{ V} \pm 1.4\%$  ( $T_a = 25^\circ\text{C}$ )
- Small temperature coefficient:  $|\alpha V_{REF}| = 30 \text{ ppm}/^\circ\text{C}$  (typ.)
- Adjustable output voltage:  $V_{REF} \leq V_{OUT} \leq 19 \text{ V}$
- Minimum cathode current for regulation:  
 $I_{kmin} = 0.5 \text{ mA}$  (max.)
- Operating temperature:  $T_a = -40 \sim 85^\circ\text{C}$
- Packages: UFV (TA76432FT), SMV (TA76432FC),  
PW-MINI (TA76432F/FR) and  
TO-92MOD (TA76432S)
- The TA76432FT is housed in an ultra-thin UFV package.  
(thickness: 0.7 mm typ.)

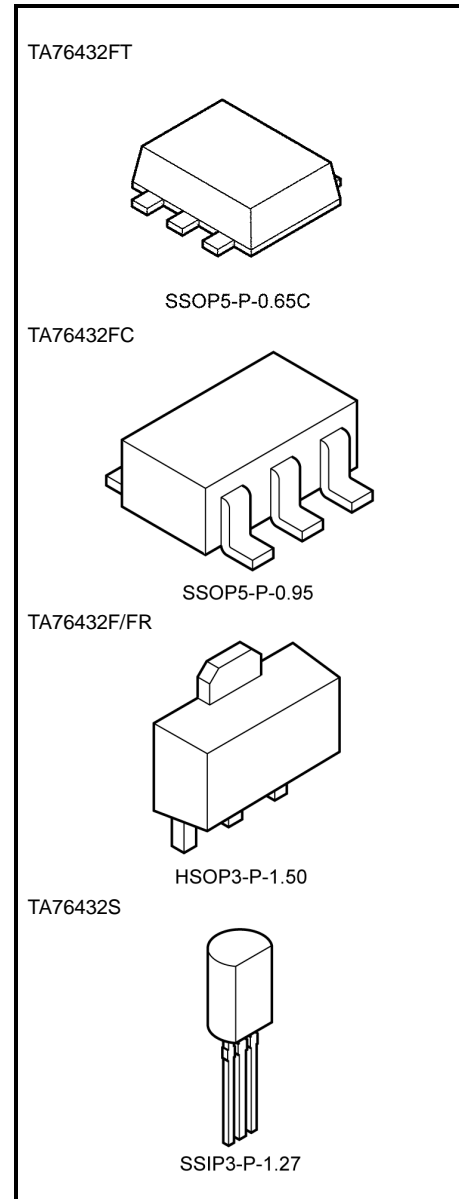

#### Weight

SSOP5-P-0.65C	: 0.007 g (typ.)
SSOP5-P-0.95	: 0.014 g (typ.)
HSOP3-P-1.50	: 0.05 g (typ.)
SSIP3-P-1.27	: 0.36 g (typ.)

## Pin Assignment/Marking

TA76432FT/TA76432FC

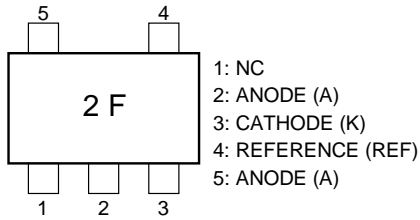

TA76432F/FR

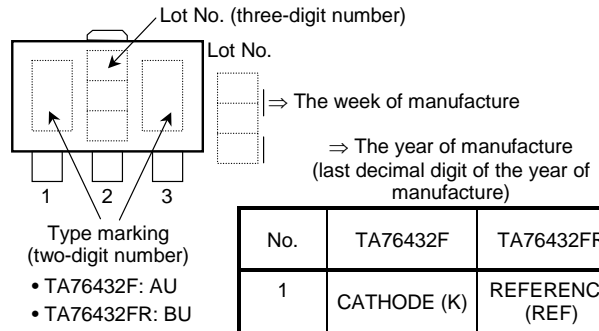

TA76432S



Lot No: Last decimal digit of the year of manufacture and January to December is denoted by alphabet A to L respectively. For example: Jan-2001 coded to "1A"

No.	TA76432F	TA76432FR
1	CATHODE (K)	REFERENCE (REF)
2	ANODE (A)	ANODE (A)
3	REFERENCE (REF)	CATHODE (K)

Note: TA76432F vs. TA76432FR: reverse pin connection.

## How to Order

Product No.	Package Type	Packing Type and Capacity	Minimum Order
TA76432FT (TE85L)	UFV (surface-mount type)	Embossed tape: 3000/tape	1 tape
TA76432FC (TE85L)	SMV (surface-mount type)	Embossed tape: 3000/tape	1 tape
TA76432F/R	PW-MINI (SOT-89) (surface-mount type)	On cut tape (TE12L): 100/tape section	100
TA76432F/R (TE12L)		Embossed tape: 1000/tape	1 tape
TA76432S	TO-92MOD (lead type)	Loose in bag: 200/bag	1 bag
TA76432S (TPE6)		Radial tape: 2000/tape	1 tape

Note: The lead pitch for the TA76432S and TA76432S (TPE6) may vary.

## Functional Block Diagram

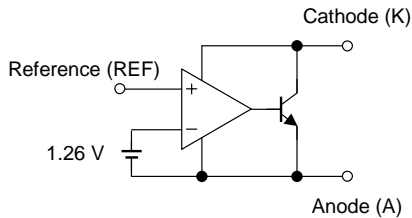

## Circuit Symbol

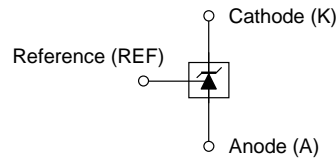

## Typical Application Circuits

1.26 V Reference ( $V_{KA} = V_{REF}$ )

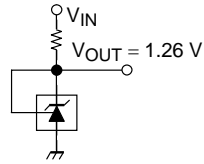

Shunt regulator ( $V_{KA} > V_{REF}$ )

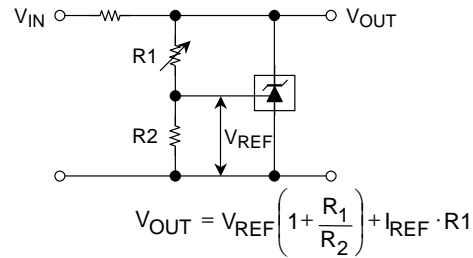

## Precautions during Use

- (1) TA76432FT, TA76432FC, TA76432F/FR, TA76432S  
These products contain MOS elements. Please take care to avoid generating static electricity when handling these devices.
- (2) TA76432FT, TA76432FC, TA76432F/FR, TA76432S  
The oscillation frequency of these devices is determined by the value of the capacitor connected between the anode and the cathode.  
When establishing maximum operating condition parameters, please derate the maximum rating values specified in these datasheets so as to allow an operational safety margin.  
Use of a laminated ceramic capacitor is recommended.
- (3) Precautions when handling anode pin of TA76432FT/TA76432FC  
Pin 2 and pin 5 should normally be shorted together. If only pin 5 is used, pin 2 should either be left open or always kept at a lower potential than pin 5. Do not leave pin 5 open and use pin 2 only.

## Maximum Ratings ( $T_a = 25^\circ\text{C}$ )

Characteristics	Symbol	Rating	Unit
Cathode voltage	$V_{KA}$	20	V
Cathode current	$I_K$	20	mA
Cathode-anode reverse current	$-I_K$	10	mA
Reference voltage	$V_{REF}$	7	V
Reference current	$I_{REF}$	50	$\mu\text{A}$
Reference-anode reverse current	$-I_{REF}$	10	mA
Power dissipation	TA76432FT	0.45 (Note 1)	W
	TA76432FC	0.2	
	TA76432F/FR	0.38 (Note 2)	
	TA76432S	0.5	
Thermal resistance	TA76432FT	277 (Note 1)	$^\circ\text{C/W}$
	TA76432FC	625	
	TA76432F/FR	328 (Note 2)	
	TA76432S	250	
Operating temperature	$T_{opr}$	-40-85	$^\circ\text{C}$
Junction temperature	$T_j$	150	$^\circ\text{C}$
Storage temperature	$T_{stg}$	-55-150	$^\circ\text{C}$

Note 1: Glass epoxy substrate mounting: 30 mm × 30 mm × 0.8 mm (Cu pad area 35 mm<sup>2</sup>)

Note 2: Glass epoxy substrate mounting: 30 mm × 30 mm × 0.8 mm (Cu pad area 50 mm<sup>2</sup>)

## Recommended Operating Conditions

Characteristics	Symbol	Min	Typ.	Max	Unit
Cathode voltage	$V_{KA}$	$V_{REF}$	—	19	V
Cathode current	$I_K$	0.5	—	15	mA
Operating temperature	$T_{opr}$	-40	—	85	°C

## Electrical Characteristics (Unless otherwise specified, $T_a = 25^\circ\text{C}$ , $I_K = 5\text{ mA}$ )

Characteristics	Symbol	Test Condition	Min	Typ.	Max	Unit
Reference voltage	$V_{REF}$	$V_{KA} = V_{REF}$	1.242	1.26	1.278	V
Deviation of reference input voltage over temperature	$V_{REF (dev)}$	$0^\circ\text{C} \leq T_a \leq 85^\circ\text{C}$ , $V_{KA} = V_{REF}$	—	3	15	mV
Ratio of change in reference input voltage to the change in cathode voltage	$\Delta V_{REF}/\Delta V$	$V_{REF} \leq V_{KA} \leq 5\text{ V}$	—	0.5	2.5	mV/V
		$5\text{ V} \leq V_{KA} \leq 19\text{ V}$	—	0.3	2.0	
Reference Input current	$I_{REF}$	$V_{KA} = V_{REF}$	—	2	4	$\mu\text{A}$
Deviation of reference input current over temperature	$I_{REF (dev)}$	$0^\circ\text{C} \leq T_a \leq 85^\circ\text{C}$ , $V_{KA} = V_{REF}$ , $R_1 = 10\text{ k}\Omega$ , $R_2 = \infty$	—	0.3	1.2	$\mu\text{A}$
Minimum cathode current for regulation	$I_{Kmin}$	$V_{KA} = V_{REF}$	—	0.2	0.5	mA
Off-State cathode current	$I_{Koff}$	$V_{KA} = 19\text{ V}$ , $V_{REF} = 0\text{ V}$	—	—	1.0	$\mu\text{A}$
Dynamic impedance	$ Z_{KA} $	$V_{KA} = V_{REF}$ , $f \leq 1\text{ kHz}$ , $0.5\text{ mA} \leq I_K \leq 15\text{ mA}$	—	0.2	0.5	$\Omega$

The deviation parameters  $V_{REF (dev)}$  and  $I_{REF (dev)}$  are defined as the maximum variation of the  $V_{REF}$  and  $I_{REF}$  over the rated temperature range.

The average temperature coefficient of the  $V_{REF}$  is defined as:

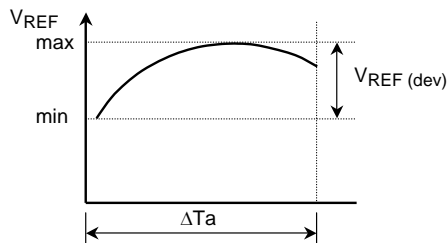

$$|\alpha V_{REF}| = \frac{\left( \frac{V_{REF (dev)} \times 10^6}{V_{REF @ 25^\circ\text{C}}} \right)}{\Delta T_a} \text{ (ppm/}^\circ\text{C)}$$

## Application Circuit Example

Error amplification circuit for switching power supply

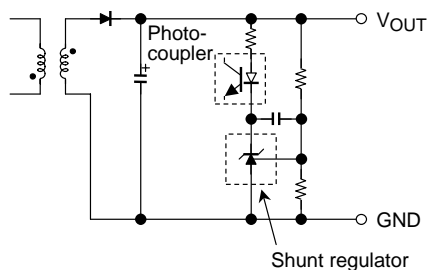

This circuit amplifies the difference between the switching power supply's secondary output voltage and the shunt regulator's reference voltage. It then feeds the amplified voltage back to the primary input voltage via the photocoupler.

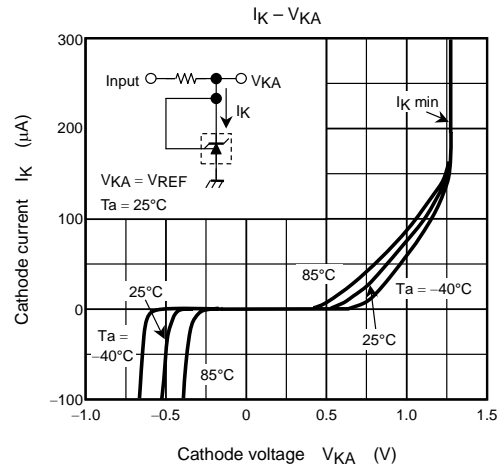
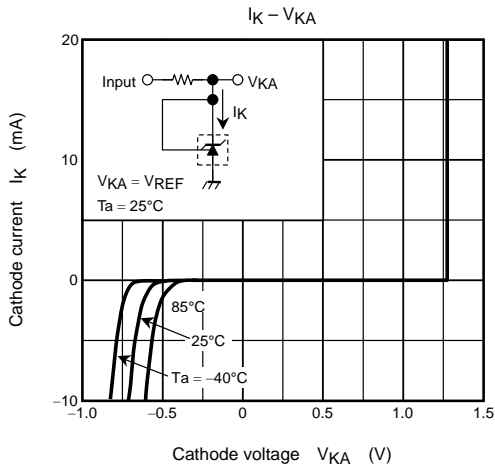
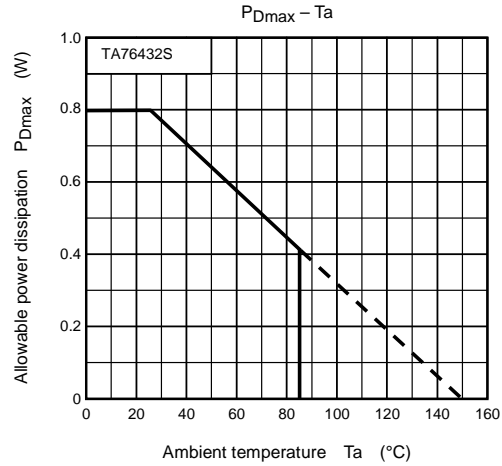
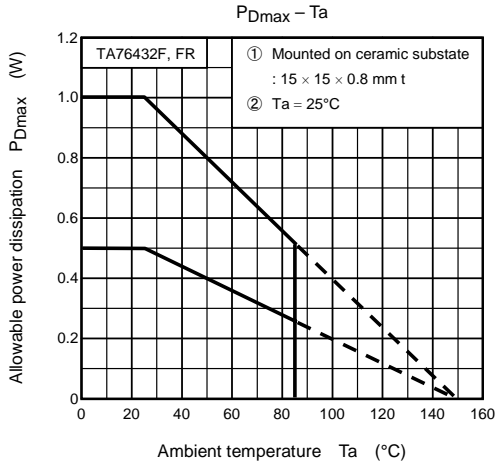
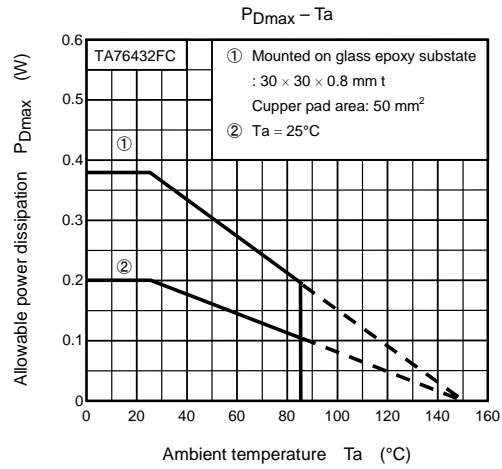
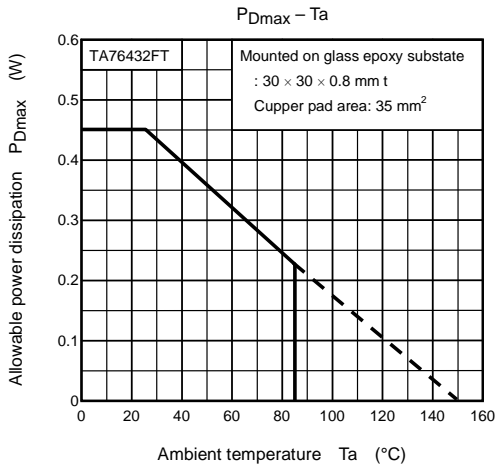

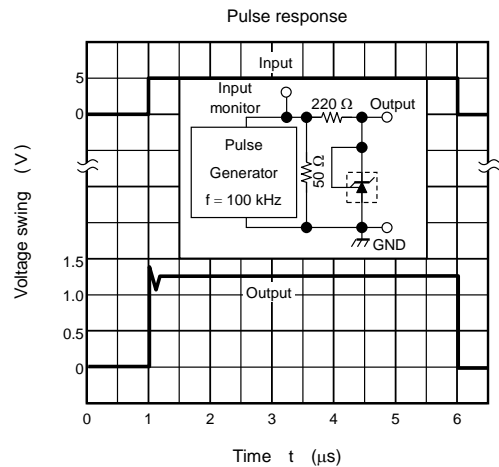
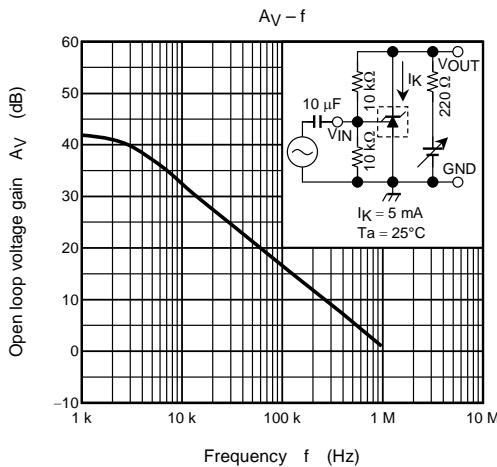
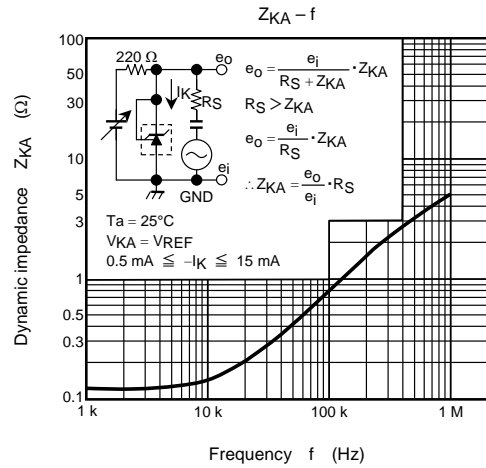
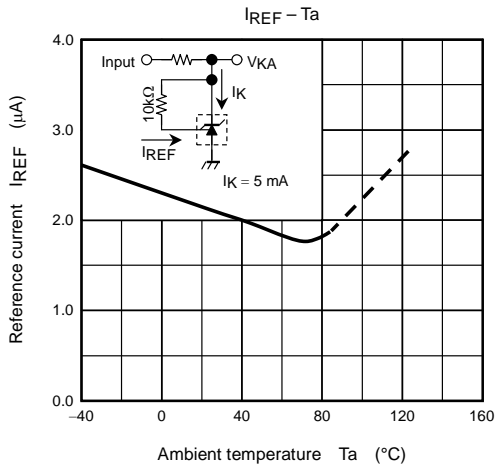
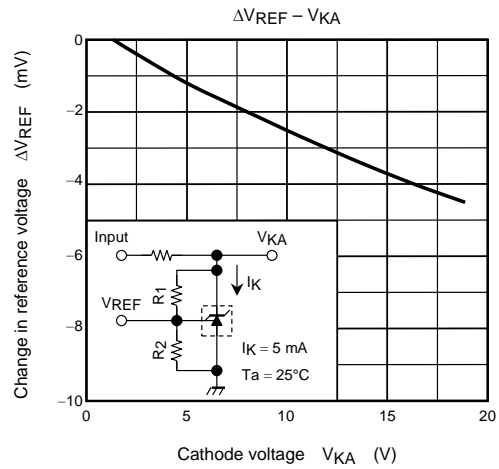
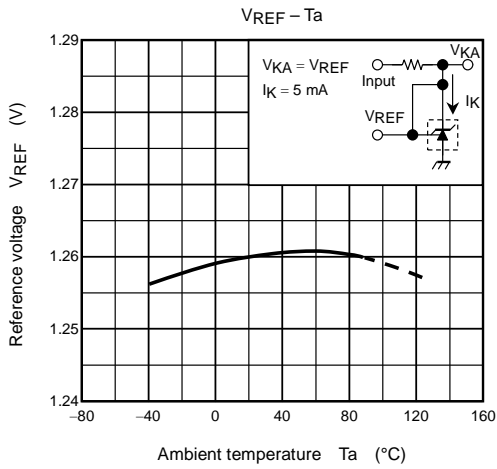

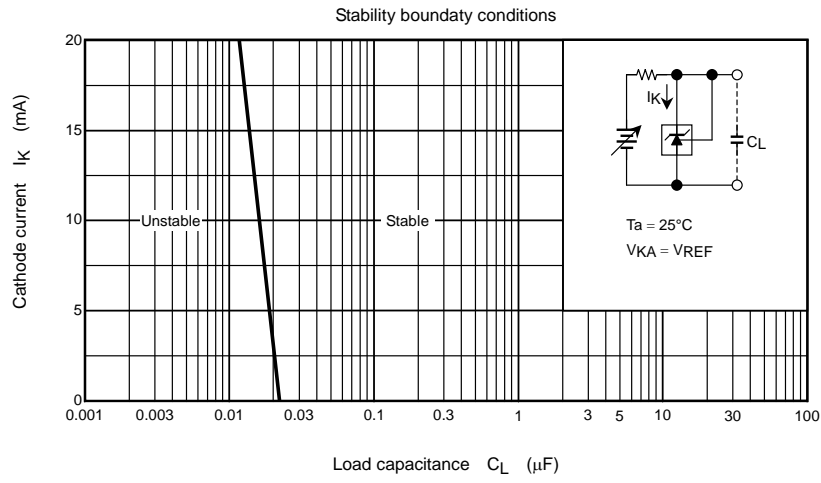

## Package Dimensions

SSOP5-P-0.65C

Unit: mm

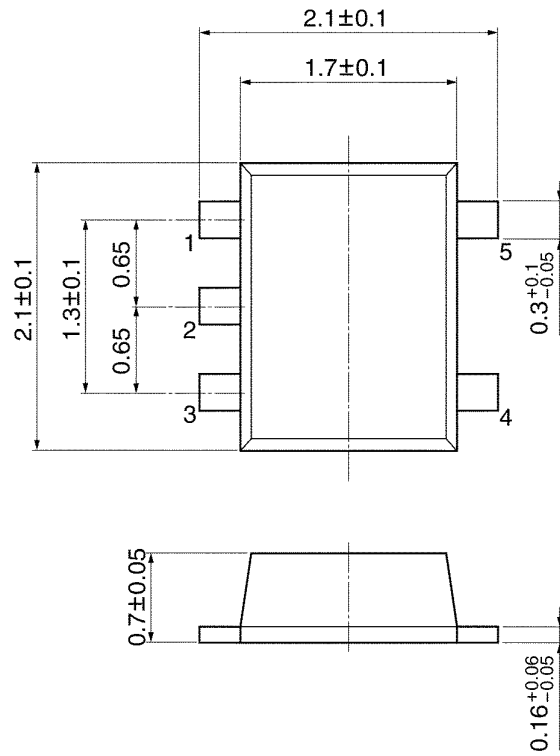

TA76432FT (UFV)

Weight: 0.007 g (typ.)



## Package Dimensions

SSOP5-P-0.95

Unit : mm

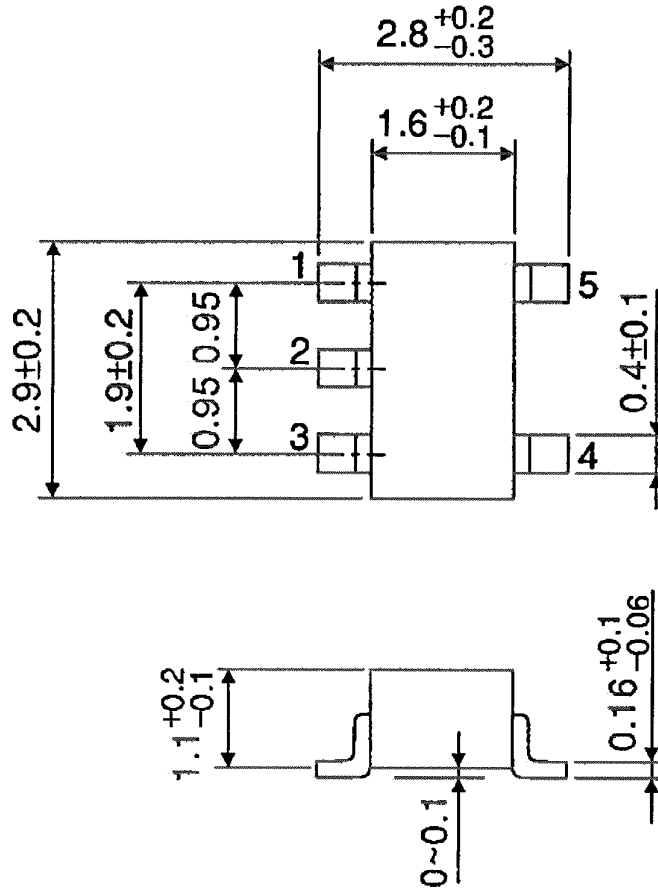

TA76432FC (SMV)

Weight: 0.014 g (typ.)

## Package Dimensions

HSOP3-P-1.50

Unit : mm

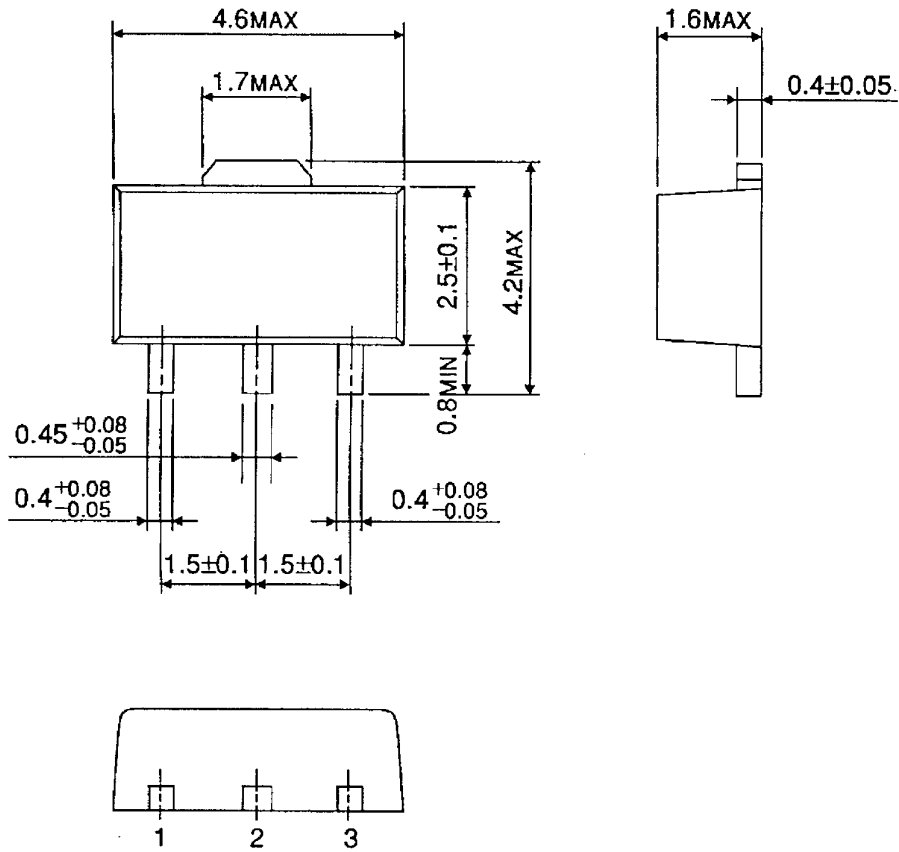

TA76432F/FR (PW-MINI)

Weight: 0.05 g (typ.)

## Package Dimensions

SSIP3-P-1.27

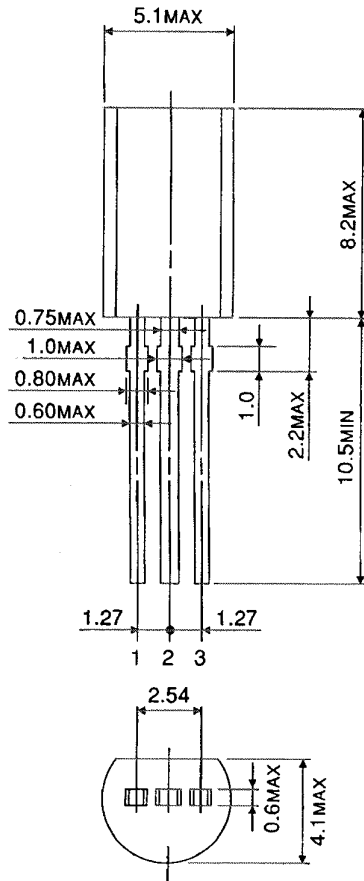

TA76432S (TO-92MOD)

Weight: 0.36 g (typ.)

**RESTRICTIONS ON PRODUCT USE**

000707EBA

- TOSHIBA is continually working to improve the quality and reliability of its products. Nevertheless, semiconductor devices in general can malfunction or fail due to their inherent electrical sensitivity and vulnerability to physical stress. It is the responsibility of the buyer, when utilizing TOSHIBA products, to comply with the standards of safety in making a safe design for the entire system, and to avoid situations in which a malfunction or failure of such TOSHIBA products could cause loss of human life, bodily injury or damage to property.  
In developing your designs, please ensure that TOSHIBA products are used within specified operating ranges as set forth in the most recent TOSHIBA products specifications. Also, please keep in mind the precautions and conditions set forth in the "Handling Guide for Semiconductor Devices," or "TOSHIBA Semiconductor Reliability Handbook" etc..
- The TOSHIBA products listed in this document are intended for usage in general electronics applications (computer, personal equipment, office equipment, measuring equipment, industrial robotics, domestic appliances, etc.). These TOSHIBA products are neither intended nor warranted for usage in equipment that requires extraordinarily high quality and/or reliability or a malfunction or failure of which may cause loss of human life or bodily injury ("Unintended Usage"). Unintended Usage include atomic energy control instruments, airplane or spaceship instruments, transportation instruments, traffic signal instruments, combustion control instruments, medical instruments, all types of safety devices, etc.. Unintended Usage of TOSHIBA products listed in this document shall be made at the customer's own risk.
- The products described in this document are subject to the foreign exchange and foreign trade laws.
- The information contained herein is presented only as a guide for the applications of our products. No responsibility is assumed by TOSHIBA CORPORATION for any infringements of intellectual property or other rights of the third parties which may result from its use. No license is granted by implication or otherwise under any intellectual property or other rights of TOSHIBA CORPORATION or others.
- The information contained herein is subject to change without notice.