

M5M5256CFP, VP, RV-12VLL, -15VLL, -12VXL, -15VXL

262144-BIT(32768-WORD BY 8-BIT)CMOS STATIC RAM

DESCRIPTION

This M5M5256CFP, VP, RV is a 262144-bit CMOS static RAMs organized as 32768-words by 8-bits which is fabricated using high-performance 3 polysilicon CMOS technology. The use of resistive load NMOS cells and CMOS periphery result in a high-density and low-power static RAM. They are low stand-by current and low voltage operation (3V) and ideal for the battery operation application.

Especially the M5M5256CVP, RV are packaged in a 28-pin thin small outline package. Two types of devices are available, M5M5256CVP (normal lead bend type package) and M5M5256CRV (reverse lead bend type package). Using both type of devices, it becomes very easy to design a printed circuit board.

FEATURES

Type name	Access time (max)	Power supply current	
		Active (max)	Stand-by (max)
M5M5256CFP, VP, RV-12VLL M5M5256CFP, VP, RV-15VLL	120ns 150ns	50mA (V _{CC} =5.5V)	11 μA (V _{CC} = 3.3V)
M5M5256CFP, VP, RV-12VXL M5M5256CFP, VP, RV-15VXL	120ns 150ns	20mA (V _{CC} =3.3V)	2.2 μA (V _{CC} = 3.3V) 0.05 μA (V _{CC} = 3V, typ)

- Single + 2.7~5.5V power supply
- No clocks, no refresh
- Data-hold on + 2V power supply
- Directly TTL compatible: All inputs and outputs
- Three-state outputs: OR-tie capability
- Simple memory expansion by \bar{S}
- \bar{OE} prevents data contention in the I/O bus
- Common data I/O
- Low stand-by current.....0.05 μA (typ)
- Package
 M5M5256CFP.....28 pin 450 mil SOP
 M5M5256CVP, RV.....28pin 8 × 13.4mm² TSOP

APPLICATION

Small capacity memory units

PIN CONFIGURATION (TOP VIEW)

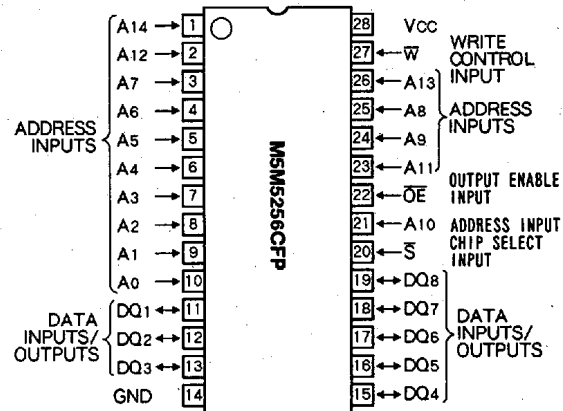

Outline 28P2W-C

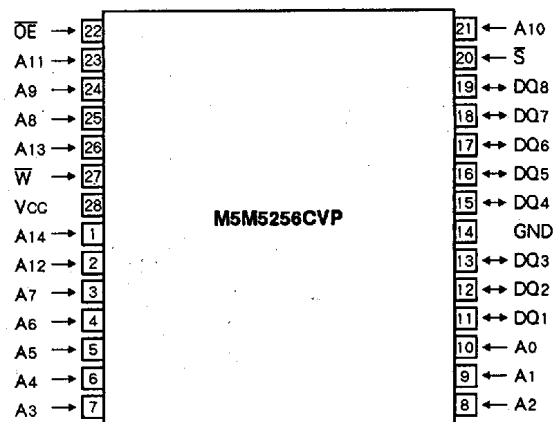

Outline 28P2C-A

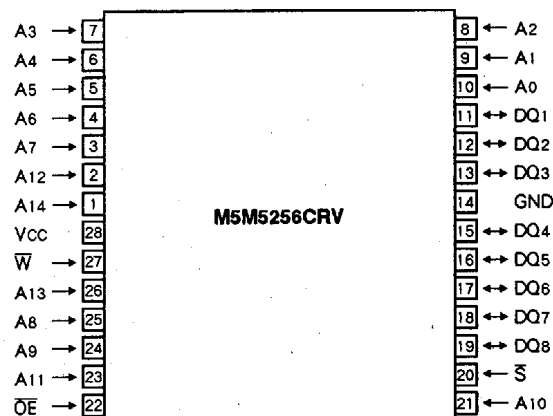

Outline 28P2C-B

M5M5256CFP,VP,RV-12VLL,-15VLL,-12VXL,-15VXL

262144-BIT(32768-WORD BY 8-BIT)CMOS STATIC RAM

FUNCTION

The operation mode of the M5M5256CFP,VP,RV is determined by a combination of the device control inputs \bar{S} , \bar{W} and \bar{OE} . Each mode is summarized in the function table.

A write cycle is executed whenever the low level \bar{W} overlaps with the low level \bar{S} . The address must be set-up before the write cycle and must be stable during the entire cycle. The data is latched into a cell on the trailing edge of \bar{W} , \bar{S} , whichever occurs first, requiring the set-up and hold time relative to these edge to be maintained. The output enable \bar{OE} directly controls the output stage. Setting the \bar{OE} at a high level, the output stage is in a high-impedance state, and the data bus contention problem in the write cycle is eliminated.

A read cycle is executed by setting \bar{W} at a high level and \bar{OE} at a low level while \bar{S} are in an active state.

When setting \bar{S} at a high level, the chip is in a non-selectable mode in which both reading and writing are disabled. In this mode, the output stage is in a high-impedance state, allowing OR-tie with other chips and memory expansion by \bar{S} . The power supply current is reduced as low as the stand-by current which is specified as I_{cc3} or I_{cc4} , and the memory data can be held +2V power supply, enabling battery back-up operation during power failure or power-down operation in the non-selected mode.

FUNCTION TABLE

\bar{S}	\bar{W}	\bar{OE}	Mode	DQ	I_{cc}
H	X	X	Non selection	High-impedance	Stand-by
L	L	X	Write	D_{in}	Active
L	H	L	Read	D_{out}	Active
L	H	H		High-impedance	Active

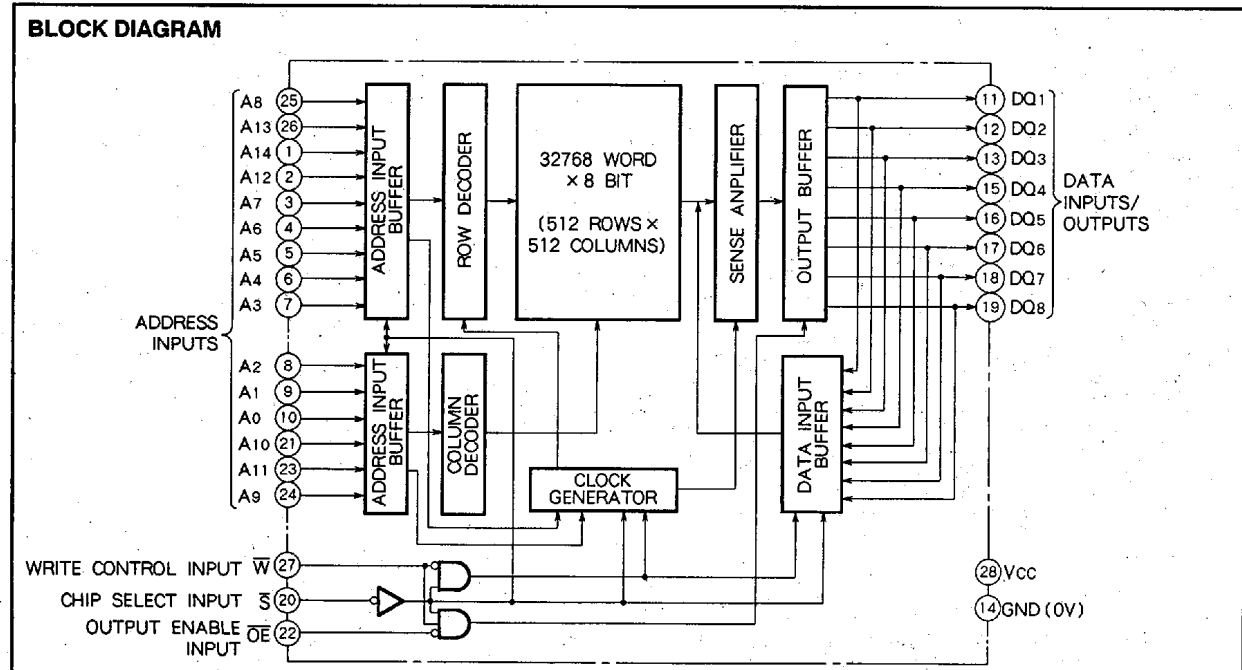

6249825 0027891 388

M5M5256CFP,VP,RV-12VLL,-15VLL,-12VXL,-15VXL

262144-BIT(32768-WORD BY 8-BIT)CMOS STATIC RAM

ABSOLUTE MAXIMUM RATINGS

Symbol	Parameter	Conditions	Ratings	Unit
V _{cc}	Supply voltage	With respect to GND	-0.3~7	V
V _I	Input voltage		-0.3*~V _{cc} +0.3	V
V _O	Output voltage		0~V _{cc}	V
P _d	Power dissipation	T _a = 25°C	700	mW
T _{opr}	Operating temperature		0~70	°C
T _{stg}	Storage temperature		-65~150	°C

* -3.0V in case of AC (Pulse width ≥ 30ns)

DC ELECTRICAL CHARACTERISTICS (T_a = 0~70°C, V_{cc} = 2.7~5.5V, unless otherwise noted)

Symbol	Parameter	Test conditions	Limits 1 (V _{cc} = 5V ± 10%)			Limits 2 (V _{cc} = 3V ± 10%)			Unit
			Min	Typ	Max	Min	Typ	Max	
V _{IH}	High-level input voltage		2.2		V _{cc} +0.3	2.0		V _{cc} +0.3	V
V _{IL}	Low-level input voltage		-0.3*		0.8	-0.3*		0.6	V
V _{OHI}	High-level output voltage 1	I _{OH} = -1mA (V _{cc} = 5V ± 10%) I _{OH} = -0.5mA (V _{cc} = 3V ± 10%)	2.4			2.4			V
V _{OHI2}	High-level output voltage 2	I _{OH} = -0.1mA (V _{cc} = 5V ± 10%) I _{OH} = -0.05mA (V _{cc} = 3V ± 10%)	V _{cc} -0.5			V _{cc} -0.5			V
V _{OL}	Low-level output voltage	I _{OL} = 2mA (V _{cc} = 5V ± 10%) I _{OL} = 1mA (V _{cc} = 3V ± 10%)			0.4			0.4	V
I _I	Input leakage current	V _I = 0~V _{cc}			±1			±1	μA
I _O	Output leakage current	\bar{S} = V _{IH} or OE = V _{IH} , V _{I/O} = 0~V _{cc}			±1			±1	μA
I _{cc1}	Active supply current (AC, MOS level)	\bar{S} ≤ 0.2V Other inputs ≤ 0.2V or ≥ V _{cc} - 0.2V Output open	Min. cycle	30	45	10	20		mA
			1MHz	4	8	1.5	3		
I _{cc2}	Active supply current (AC, TTL level)	\bar{S} = V _{IL} , Other inputs = V _{IL} or V _{IH} Output open	Min. cycle	35	50	10	20		mA
			1MHz	5	10	1.5	3		
I _{cc3}	Stand-by supply current	\bar{S} ≥ V _{cc} - 0.2V, Other inputs = 0~V _{cc}	-VLL		20			11	μA
			-VXL	0.1	5	0.05	2.2		
I _{cc4}	Stand-by supply current	\bar{S} = V _{IH} , Other inputs = 0~V _{cc}			3			0.3	mA

* -3.0V in case of AC (Pulse width ≤ 30ns)

CAPACITANCE (T_a = 0~70°C, V_{cc} = 2.7~5.5V, unless otherwise noted)

Symbol	Parameter	Test conditions	Limits			Unit
			Min	Typ	Max	
C _I	Input capacitance	V _I = GND, V _I = 25mV _{rms} , f = 1MHz			6	pF
C _O	Output capacitance	V _O = GND, V _O = 25mV _{rms} , f = 1MHz			8	pF

Note 1. Direction for current flowing into IC is indicated as positive. (no mark)

2. Typical value is V_{cc} = 5V or 3V, T_a = 25°C.3. C_I, C_O are periodically sampled and are not 100% tested.

6249825 0027892 214

M5M5256CFP,VP,RV-12VLL,-15VLL,-12VXL,-15VXL

262144-BIT(32768-WORD BY 8-BIT)CMOS STATIC RAM

AC ELECTRICAL CHARACTERISTICS (Ta = 0~70°C, Vcc = 2.7~5.5V, unless otherwise noted)

(1) MEASUREMENT CONDITIONS

Input pulse level $V_{IH} = 2.4V, V_{IL} = 0.6V$ ($V_{CC} = 5V \pm 10\%$)
 $V_{IH} = 2.2V, V_{IL} = 0.4V$ ($V_{CC} = 3V \pm 10\%$)

Input rise and fall time5ns

Reference level $V_{OH} = V_{OL} = 1.5V$

Transition is measured $\pm 500mV$ from steady state voltage.(for t_{en}, t_{dis})

Output loadsFig.1, $C_L = 100pF$ (FP, VP, RV- 15VLL, - 15VXL)
 $C_L = 50pF$ (FP, VP, RV- 12VLL, - 12VXL)
 $C_L = 5pF$ (for t_{en}, t_{dis})

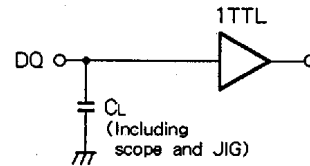

Fig.1 Output load

(2) READ CYCLE

Symbol	Parameter	Limits						Unit
		M5M5256C-12VLL M5M5256C-12VXL			M5M5256C-15VLL M5M5256C-15VXL			
		Min	Typ	Max	Min	Typ	Max	
t_{CR}	Read cycle time	120			150			ns
$t_a(A)$	Address access time			120			150	ns
$t_a(S)$	Chip select access time			120			150	ns
$t_a(OE)$	Output enable access time			60			75	ns
$t_{dis}(S)$	Output disable time after \bar{S} high			35			40	ns
$t_{dis}(OE)$	Output disable time after \bar{OE} high			35			40	ns
$t_{en}(S)$	Output enable time after \bar{S} low	10			10			ns
$t_{en}(OE)$	Output enable time after \bar{OE} low	10			10			ns
$t_v(A)$	Data valid time after address	10			10			ns

(3) WRITE CYCLE

Symbol	Parameter	Limits						Unit
		M5M5256C-12VLL M5M5256C-12VXL			M5M5256C-15VLL M5M5256C-15VXL			
		Min	Typ	Max	Min	Typ	Max	
t_{CW}	Write cycle time	120			150			ns
$t_{W(W)}$	Write pulse width	80			90			ns
$t_{su}(A)$	Address set up time	0			0			ns
$t_{su}(A-WH)$	Address set up time with respect to \bar{W} high	90			100			ns
$t_{su}(S)$	Chip select set up time	90			100			ns
$t_{su}(D)$	Data set up time	45			50			ns
$t_h(D)$	Data hold time	0			0			ns
$t_{rec}(W)$	Write recovery time	0			0			ns
$t_{dis}(W)$	Output disable time after \bar{W} low			35			40	ns
$t_{dis}(OE)$	Output disable time after \bar{OE} high			35			40	ns
$t_{en}(W)$	Output enable time after \bar{W} high	10			10			ns
$t_{en}(OE)$	Output enable time after \bar{OE} low	10			10			ns

M5M5256CFP,VP,RV-12VLL,-15VLL,-12VXL,-15VXL

262144-BIT(32768-WORD BY 8-BIT)CMOS STATIC RAM

(4) TIMING DIAGRAMS

Read cycle

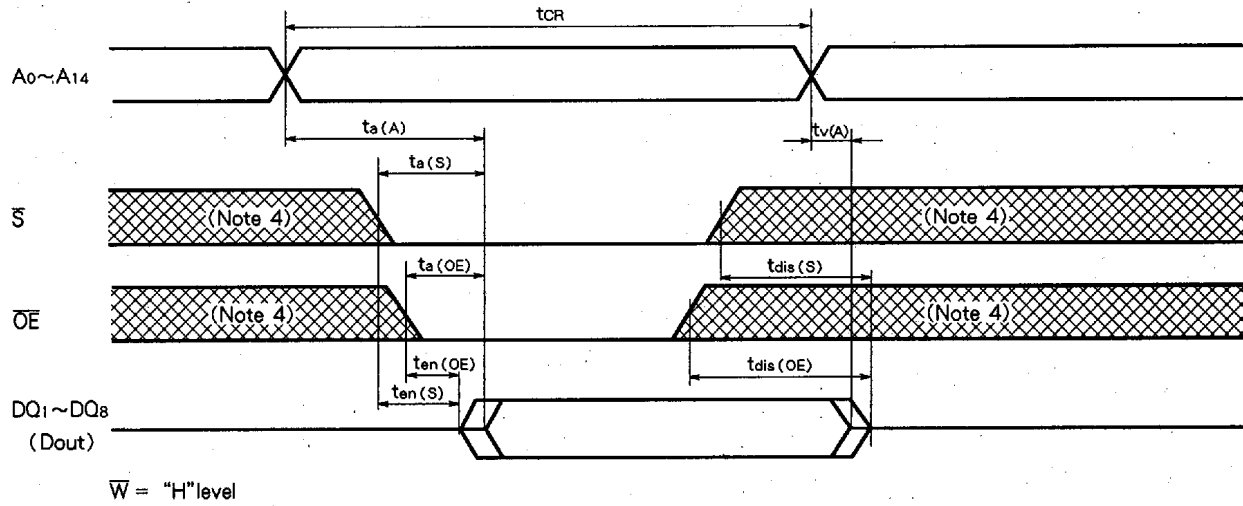

Write cycle (\bar{W} control mode)

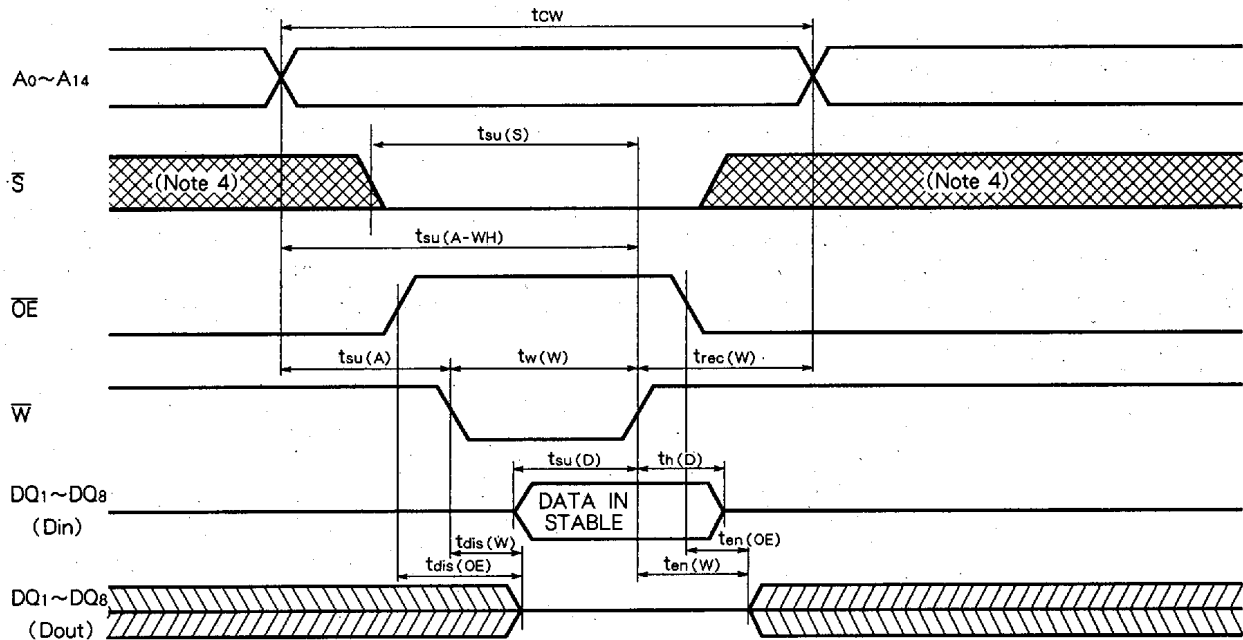

6249825 0027894 097



M5M5256CFP,VP,RV-12VLL,-15VLL,-12VXL,-15VXL

262144-BIT(32768-WORD BY 8-BIT)CMOS STATIC RAM

Write cycle (\bar{S} control mode)

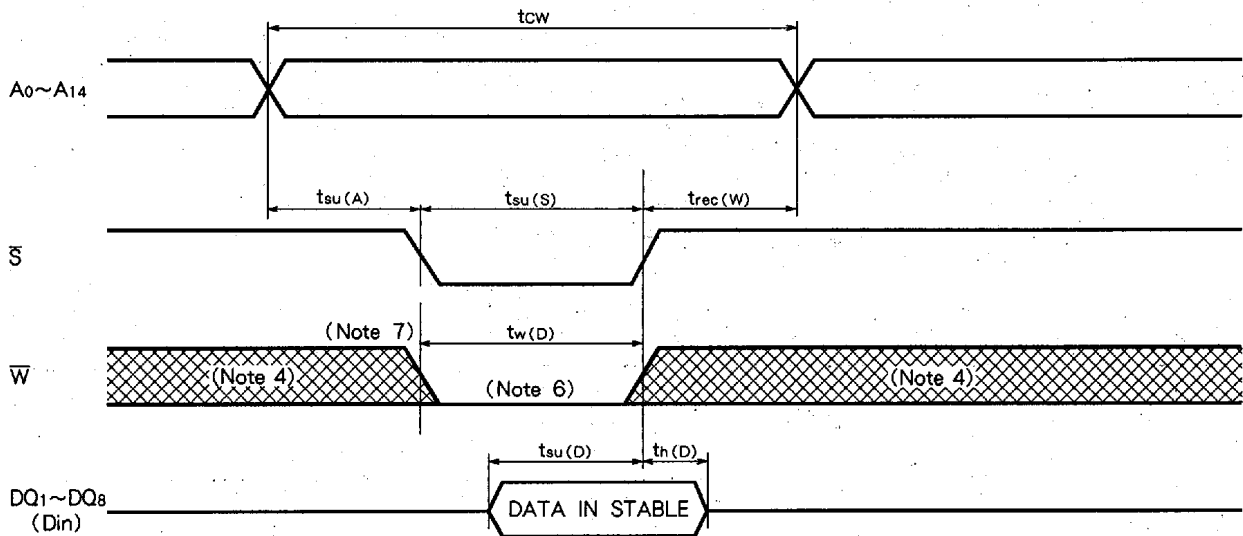

- Note 4. Hatching indicates the state is don't care.
- 5. Writing is executed in overlap of \bar{S} and \bar{W} low.
- 6. If \bar{W} goes low simultaneously with or prior to \bar{S} , the output remains in the high-impedance state.
- 7. Don't apply inverted phase signal externally when DQ pin is in output mode.
- 8. t_{en} , t_{dis} are periodically sampled and are not 100% tested.

M5M5256CFP,VP,RV-12VLL,-15VLL,-12VXL,-15VXL

262144-BIT(32768-WORD BY 8-BIT)CMOS STATIC RAM

POWER DOWN CHARACTERISTICS

(1) ELECTRICAL CHARACTERISTICS (Ta = 0~70°C, unless otherwise noted)

Symbol	Parameter	Test conditions	Limits			Unit
			Min	Typ	Max	
V _{CC(PD)}	Power down supply voltage		2			V
V _{I(̄S)}	Chip select input \bar{S}	2.2V ≤ V _{CC(PD)} 2V ≤ V _{CC(PD)} ≤ 2.2V	2.2			V
I _{CC(PD)}	Power down supply current	V _{CC} = 3V, Other inputs = 3V	-VLL -VXL		10* 2**	μA

* Ta = 25°C, I_{CC(PD)} = 1 μA

** Ta = 25°C, I_{CC(PD)} = 0.2 μA

(2) TIMING REQUIREMENTS (Ta = 0~70°C, unless otherwise noted)

Symbol	Parameter	Test conditions	Limits			Unit
			Min	Typ	Max	
t _{su(PD)}	Power down set up time		0			ns
t _{rec(PD)}	Power down recovery time		t _{CR}			ns

(3) POWER DOWN CHARACTERISTICS

\bar{S} control mode

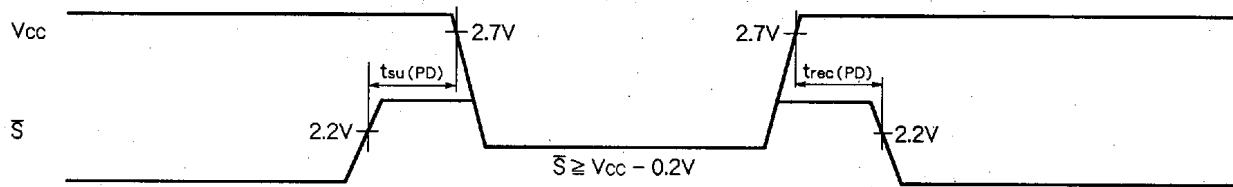

6249825 0027896 96T

