

## 2.5V/3.3V, High Bandwidth, Hot Insertion, 2-Bit, 2-Port Bus Switch w/ Individual Enables

### Features

- Near-Zero propagation delay
- 5Ω switches connect inputs to outputs
- High Bandwidth (>400 MHz)
- Rail-to-Rail, 3.3V or 2.5V Switching
- 5V I/O Tolerant
- 2.5V Supply Voltage Operation
- Permits Hot Insertion
- Packaging (Pb-free & Green Available):
  - 8-pin 173-mil wide plastic TSSOP
  - 8-pin 118-mil wide plastic MSOP

### Applications

- High Bandwidth Data Switching
- Hot Docking

### PI3C3305 Block Diagram

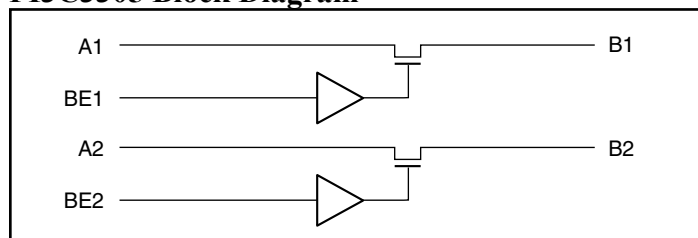

### PI3C3306 Block Diagram

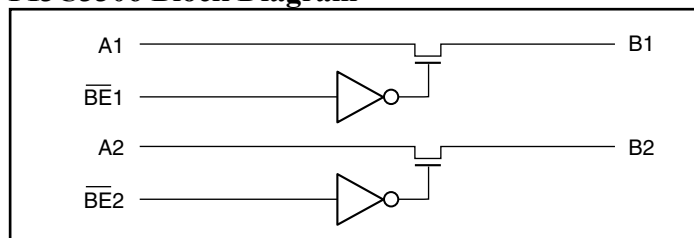

### PI3C3305 Pin Configuration

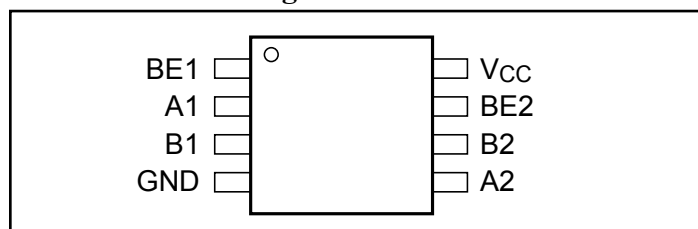

### PI3C3306 Pin Configuration

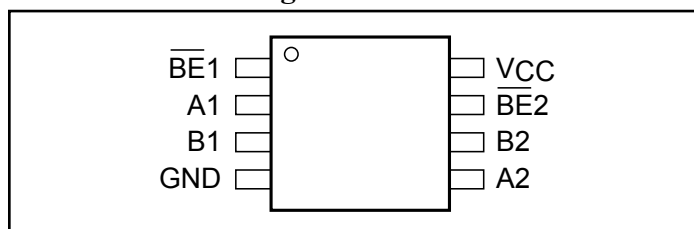

### Pin Description

Pin Name	Description
BE <sub>n</sub>	Switch Enable (PI3C3305)
$\overline{\text{BE}}_n$	Switch Enable (PI3C3306)
A2-A1	Bus A
B2-B1	Bus B
V <sub>CC</sub>	Power
GND	Ground

### Truth Table<sup>(1)</sup>

PI3C3306 $\overline{\text{BE}}_n$	PI3C3305 BE <sub>n</sub>	A <sub>n</sub>	B <sub>n</sub>	V <sub>CC</sub>	Function
X	X <sup>(2)</sup>	Hi-Z	Hi-Z	GND	Disconnect
H	L	Hi-Z	Hi-Z	V <sub>CC</sub>	Disconnect
L	H	B <sub>n</sub>	A <sub>n</sub>	V <sub>CC</sub>	Connect

#### Notes:

1. H = High Voltage Level; L = Low Voltage Level; Hi-Z = High Impedance; X = Don't Care
2. A pull-up resistor should be provided for power-up protection.

### Maximum Ratings

(Above which the useful life may be impaired. For user guidelines, not tested.)

Storage Temperature .....	-65°C to +150°C
Ambient Temperature with Power Applied .....	-40°C to +85°C
Supply Voltage to Ground Potential .....	-0.5V to +4.6V
DC Input Voltage .....	-0.5V to +5.5V
DC Output Current.....	120mA
Power Dissipation .....	0.5W

**Note:**

Stresses greater than those listed under MAXIMUM RATINGS may cause permanent damage to the device. This is a stress rating only and functional operation of the device at these or any other conditions above those indicated in the operational sections of this specification is not implied. Exposure to absolute maximum rating conditions for extended periods may affect reliability.

### DC Electrical Characteristics (Over Operating Range, $T_A = -40^\circ\text{C}$ to $+85^\circ\text{C}$ , $V_{CC} = 3.3\text{V} \pm 10\%$ )

Parameters	Description	Test Conditions <sup>(1)</sup>	Min.	Typ. <sup>(2)</sup>	Max.	Units
$V_{IH}$	Input HIGH Voltage	Guaranteed Logic HIGH Level	2.0			V
$V_{IL}$	Input LOW Voltage	Guaranteed Logic LOW Level	-0.5		0.8	
$I_{IH}$	Input HIGH Current	$V_{CC} = \text{Max.}, V_{IN} = V_{CC}$			$\pm 1$	$\mu\text{A}$
$I_{IL}$	Input LOW Current	$V_{CC} = \text{Max.}, V_{IN} = \text{GND}$			$\pm 1$	
$I_{OZH}$	High Impedance Output Current	$0 \leq A, B \leq V_{CC}$			$\pm 1$	
$V_{IK}$	Clamp Diode Voltage	$V_{CC} = \text{Min.}, I_{IN} = -18\text{mA}$		-0.73	-1.2	V
$R_{ON}$	Switch On Resistance <sup>(4)</sup>	$V_{CC} = \text{Min.}, V_{IN} = 0.0\text{V}, I_{ON} = 48\text{mA}$ or $60\text{mA}$		5	7	$\Omega$
		$V_{CC} = \text{Min.}, V_{IN} = 2.4\text{V}, I_{ON} = 15\text{mA}$		8	15	

### Capacitance ( $T_A = 25^\circ\text{C}$ , $f = 1\text{MHz}$ )

Parameters <sup>(5)</sup>	Description	Test Conditions	Typ.	Units
$C_{IN}$	Input Capacitance	$V_{IN} = 0\text{V}$	3.5	pF
$C_{OFF}$	A/B Capacitance, Switch Off		5.0	
$C_{ON}$	A/B Capacitance, Switch On		10.0	

**Notes:**

- For Max. or Min. conditions, use appropriate value specified under Electrical Characteristics for the applicable device type.
- Typical values are at  $V_{CC} = 3.3\text{V}$ ,  $T_A = 25^\circ\text{C}$  ambient and maximum loading.
- Not more than one output should be shorted at one time. Duration of the test should not exceed one second.
- Measured by the voltage drop between A and B pin at indicated current through the switch. On-Resistance is determined by the lower of the voltages on the two (A,B) pins.
- This parameter is determined by device characterization but is not production tested.

### Power Supply Characteristics

Parameters	Description	Test Conditions <sup>(1)</sup>		Min.	Typ. <sup>(2)</sup>	Max.	Units
I <sub>CC</sub>	Quiescent Power Supply Current	V <sub>CC</sub> = Max.	V <sub>IN</sub> = GND or V <sub>CC</sub>		260	500	μA
ΔI <sub>CC</sub>	Supply Current per Input HIGH	V <sub>CC</sub> = Max.	V <sub>IN</sub> = 3.0V <sup>(3)</sup>			750	

**Notes:**

1. For Max. or Min. conditions, use appropriate value specified under Electrical Characteristics for the applicable device.
2. Typical values are at V<sub>CC</sub> = 3.3V, +25°C ambient.
3. Per driven input (control input only); A and B pins do not contribute to ΔI<sub>CC</sub>.

### Switching Characteristics over 3.3V Operating Range

Parameters	Description	Test Conditions <sup>(1)</sup>	3305/3306		Units
			Com		
			Min.	Max.	
t <sub>PLH</sub> t <sub>PHL</sub>	Propagation Delay <sup>(2, 3)</sup> A to B, B to A	C <sub>L</sub> = 50pF, R <sub>L</sub> = 500Ω		0.25	ns
t <sub>PZH</sub> t <sub>PZL</sub>	Bus Enable Time	C <sub>L</sub> = 50pF, R <sub>L</sub> = 500Ω,	1.5	6.5	
t <sub>PHZ</sub> t <sub>PLZ</sub>	Bus Disable Time	R = 500Ω	1.5	5.5	

### Switching Characteristics over 2.5V Operating Range

Parameters	Description	Test Conditions <sup>(1)</sup>	3305/3306		Units
			Com		
			Min.	Max.	
t <sub>PLH</sub> t <sub>PHL</sub>	Propagation Delay <sup>(2, 3)</sup> A to B, B to A	C <sub>L</sub> = 50pF, R <sub>L</sub> = 500Ω		0.25	ns
t <sub>PZH</sub> t <sub>PZL</sub>	Bus Enable Time	C <sub>L</sub> = 50pF, R <sub>L</sub> = 500Ω,	1.5	9.8	
t <sub>PHZ</sub> t <sub>PLZ</sub>	Bus Disable Time	R = 500Ω	1.5	8.3	

**Notes:**

1. See test circuit and waveforms.
2. This parameter is guaranteed but not tested on Propagation Delays.
3. The bus switch contributes no propagational delay other than the RC delay of the On-Resistance of the switch and the load capacitance. The time constant for the switch alone is of the order of 0.25ns for 50pF load. Since this time constant is much smaller than the rise/fall times of typical driving signals, it adds very little propagational delay to the system. Propagational delay of the bus switch when used in a system is determined by the driving circuit on the driving side of the switch and its interaction with the load on the driven side.

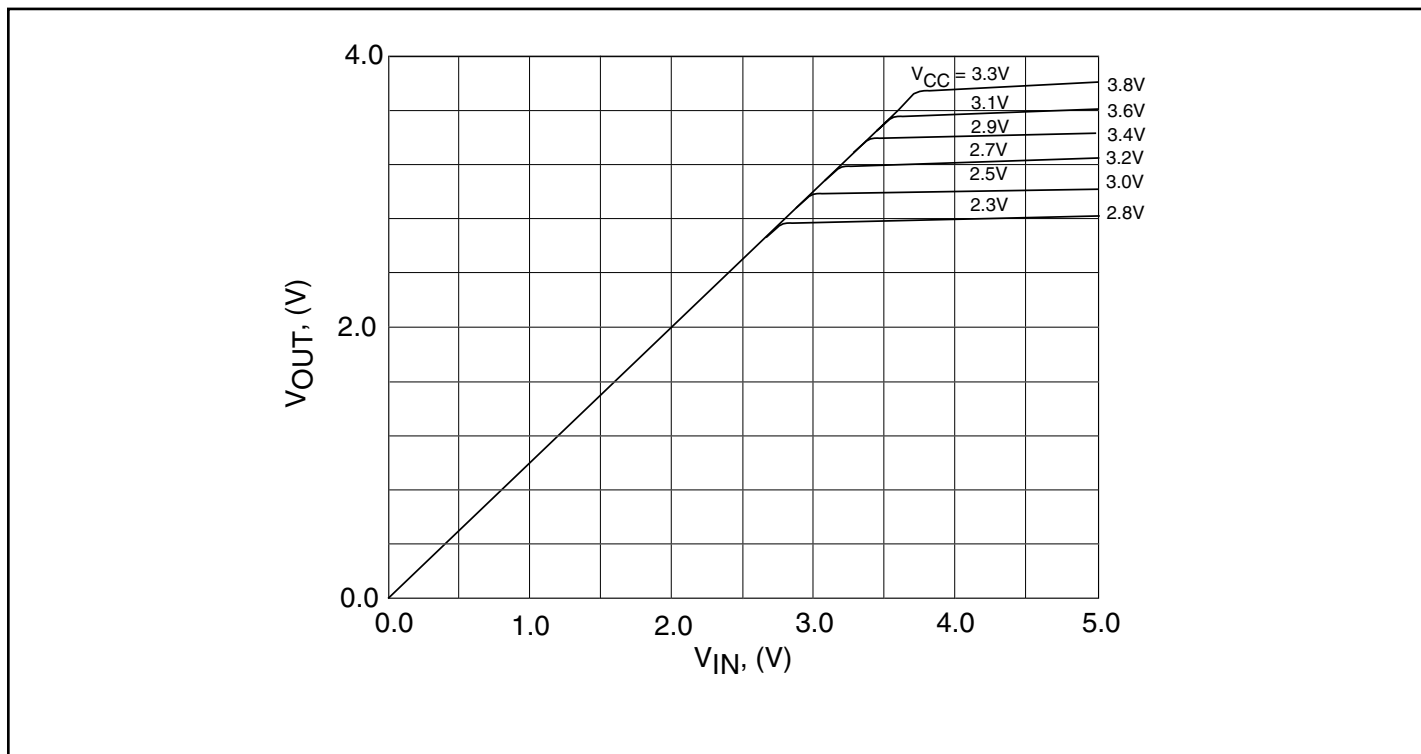

Output Voltage vs. Input Voltage over Various Supply Voltages

## Application Information

### Logic Inputs

The logic control input can be driven up to +3.6V regardless of the supply voltage. For example, given a +3.3V supply, IN may be driven LOW to 0V and HIGH to 3.6V. Driving IN Rail-to-Rail minimizes power consumption.

### Power-Supply Sequencing

Proper power-supply sequencing is advised for all CMOS devices. It is recommended to always apply V<sub>CC</sub> before applying signals to the input/output or control pins.

*Rail-to-Rail is a registered trademark of Nippon Motorola, Ltd*

Packaging Mechanical: 8-Pin TSSOP (L)

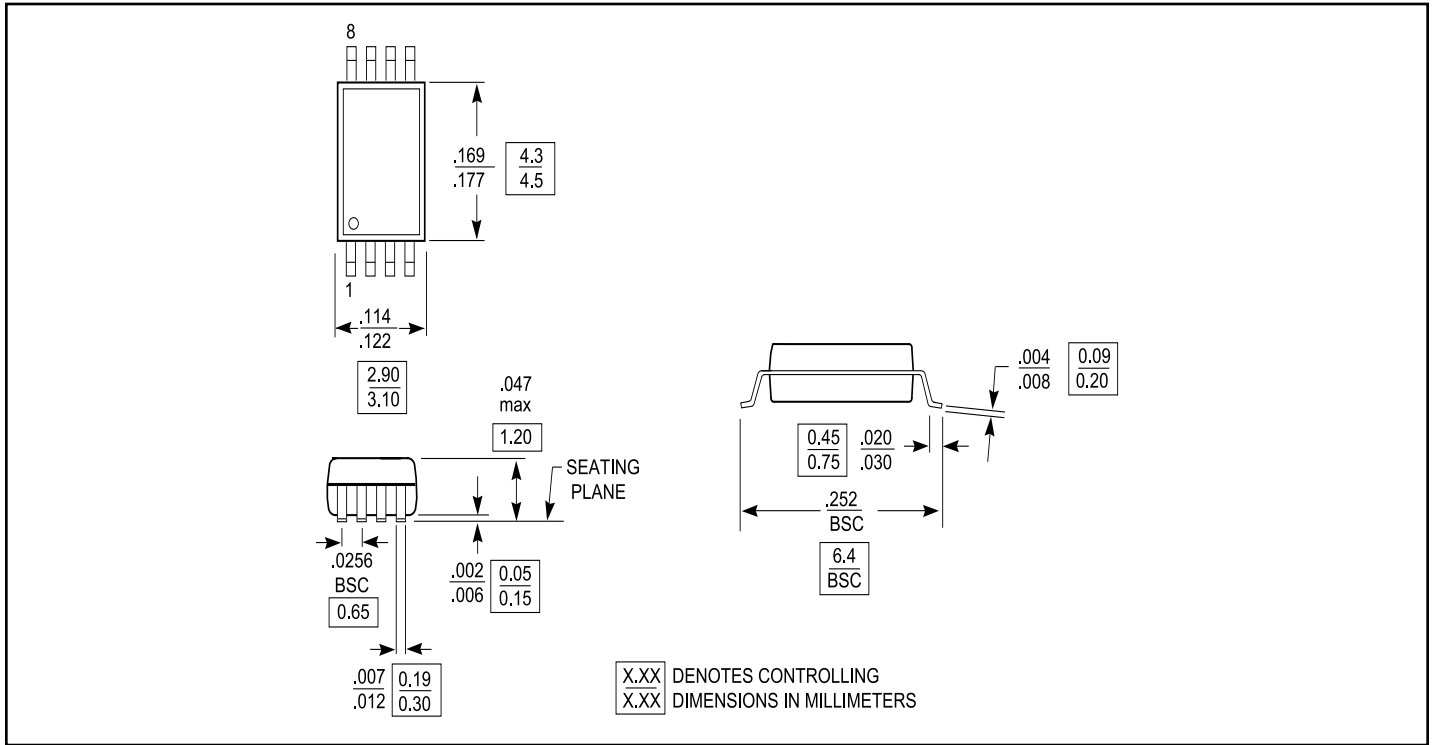

Packaging Mechanical: 8-Pin MSOP (U)

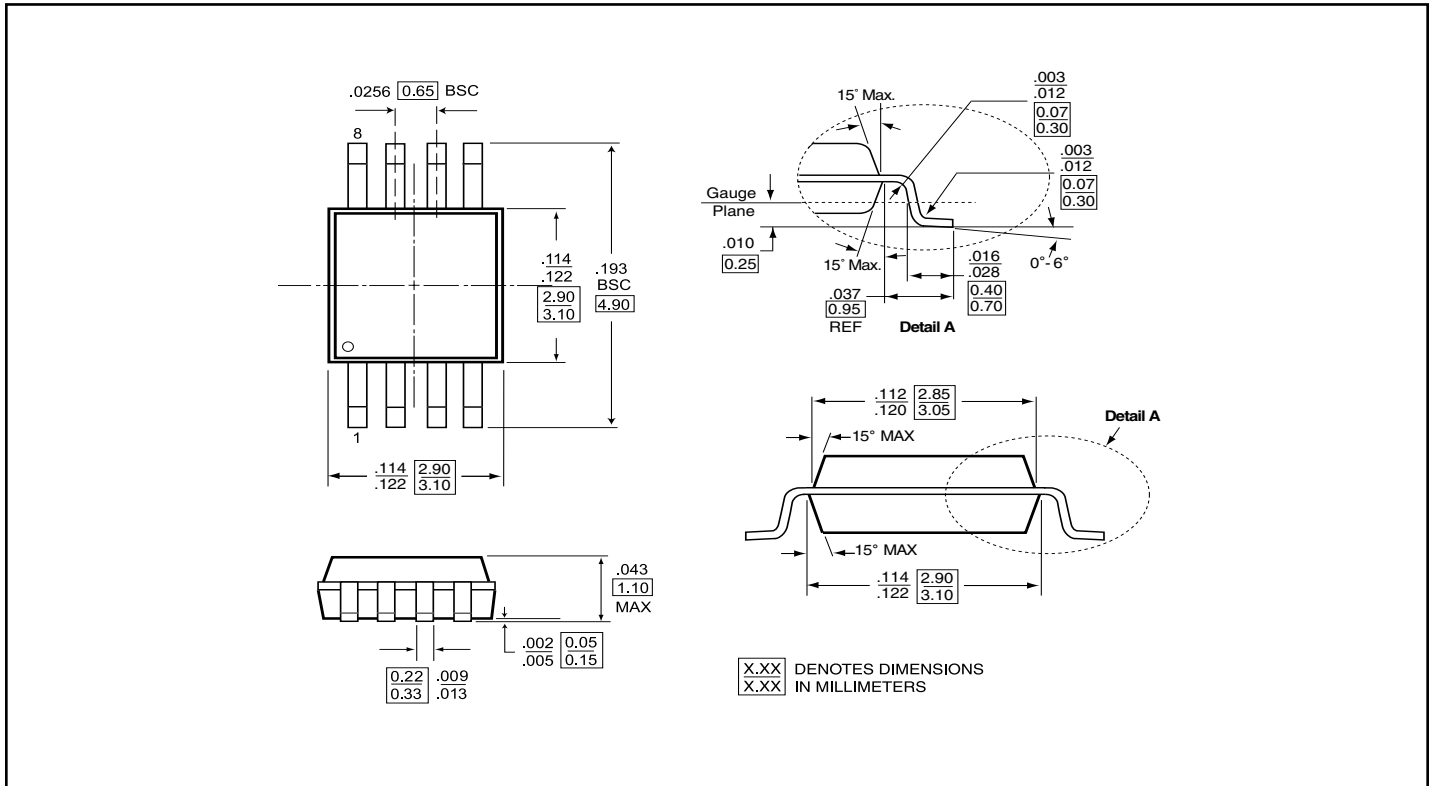

**Ordering Information**

<b>Ordering Code</b>	<b>Package Code</b>	<b>Description</b>
PI3C3305L	L	8-pin 173-mil wide plastic TSSOP
PI3C3305U	U	8-pin 118-mil wide plastic MSOP
PI3C3305UE	U	Pb-free & Green 8-pin 118-mil wide plastic MSOP
PI3C3306L	L	8-pin 173-mil wide plastic TSSOP
PI3C3306LE	L	Pb-free & Green 8-pin 173-mil wide plastic TSSOP
PI3C3306U	U	8-pin 118-mil wide plastic MSOP

**Notes:**

1. Thermal characteristics can be found on the company web site at [www.pericom.com/packaging/](http://www.pericom.com/packaging/)