

## Features

- Specified for +3V, +5V, or ±5V applications
- Large input common mode range  $0V < V_{CM} < V_S - 1.2V$
- Output swings to ground without saturating
- -3dB bandwidth = 125MHz
- ± 0.1dB bandwidth = 30MHz
- Low supply current = 5mA (per amplifier)
- Slew rate = 275V/μs
- Low offset voltage = 4mV max
- Output current = ±100mA
- High open loop gain = 80dB
- Differential gain = 0.05%
- Differential phase = 0.05°

## Applications

- Video amplifiers
- PCMCIA applications
- A/D drivers
- Line drivers
- Portable computers
- High speed communications
- RGB printers, FAX, scanners
- Broadcast equipment
- Active filtering

## Ordering Information

Part No	Package	Tape & Reel	Outline #
EL2250CN	8-Pin PDIP	-	MDP0031
EL2250CS	8-Pin SO	-	MDP0027
EL2250CS-T7	8-Pin SO	7"	MDP0027
EL2250CS-T13	8-Pin SO	13"	MDP0027
EL2450CN	14-Pin PDIP	-	MDP0031
EL2450CS	14-Pin SO	-	MDP0027
EL2450CS-T7	14-Pin SO	7"	MDP0027
EL2450CS-T13	14-Pin SO	13"	MDP0027

## General Description

The EL2250C/EL2450C are part of a family of the electronics industries fastest single supply op amps available. Prior single supply op amps have generally been limited to bandwidths and slew rates to that of the EL2250C/EL2450C. The 125MHz bandwidth, 275V/μs slew rate, and 0.05%/0.05° differential gain/differential phase makes this part ideal for single or dual supply video speed applications. With its voltage feedback architecture, this amplifier can accept reactive feedback networks, allowing them to be used in analog filtering applications. The inputs can sense signals below the bottom supply rail and as high as 1.2V below the top rail. Connecting the load resistor to ground and operating from a single supply, the outputs swing completely to ground without saturating. The outputs can also drive to within 1.2V of the top rail. The EL2250C/EL2450C will output ±100mA and will operate with single supply voltages as low as 2.7V, making them ideal for portable, low power applications.

The EL2250C/EL2450C are available in PDIP and SO packages in industry standard pin outs. Both parts operate over the industrial temperature range of -40°C to +85°C, and are part of a family of single supply op amps. For single amplifier applications, see the EL2150C/EL2157C. For dual and triple amplifiers with power down and output voltage clamps, see the EL2257C/EL2357C.

## Connection Diagrams

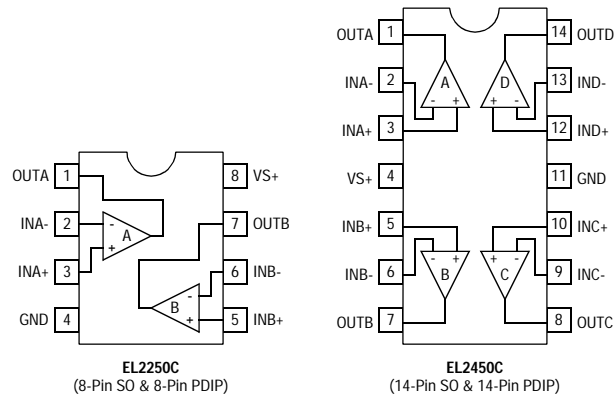

Note: All information contained in this data sheet has been carefully checked and is believed to be accurate as of the date of publication; however, this data sheet cannot be a "controlled document". Current revisions, if any, to these specifications are maintained at the factory and are available upon your request. We recommend checking the revision level before finalization of your design documentation.

© 2001 Elantec Semiconductor, Inc.

# EL2250C, EL2450C

## 125MHz Single Supply Dual/Quad Op Amps

### Absolute Maximum Ratings (T<sub>A</sub> = 25°C)

Supply Voltage between V <sub>S</sub> and GND	+12.6V	Power Dissipation	See Curves
Input Voltage (IN+, IN-)	GND-0.3V, V <sub>S</sub> +0.3V	Storage Temperature Range	-65°C to +150°C
Differential Input Voltage	±6V	Ambient Operating Temperature Range	-40°C to +85°C
Maximum Output Current	90mA	Operating Junction Temperature	150°C
Output Short Circuit Duration	(Note 1)		

#### Important Note:

All parameters having Min/Max specifications are guaranteed. Typ values are for information purposes only. Unless otherwise noted, all tests are at the specified temperature and are pulsed tests, therefore: T<sub>J</sub> = T<sub>C</sub> = T<sub>A</sub>.

### DC Electrical Characteristics

V<sub>S</sub> = +5V, GND = 0V, T<sub>A</sub> = 25°C, V<sub>CM</sub> = 1.5V, V<sub>OUT</sub> = 1.5V, unless otherwise specified.

Parameter	Description	Test Conditions	Min	Typ	Max	Unit
V <sub>OS</sub>	Offset Voltage	EL2250C	-2		2	mV
		EL2450C	-4		4	mV
TCV <sub>OS</sub>	Offset Voltage Temperature Coefficient	Measured from T <sub>MIN</sub> to T <sub>MAX</sub>		10		μV/°C
I <sub>B</sub>	Input Bias Current	V <sub>IN</sub> = 0V		-5.5	-10	μA
I <sub>OS</sub>	Input Offset Current	V <sub>IN</sub> = 0V	-750	150	750	nA
TCI <sub>OS</sub>	Input Bias Current Temperature Coefficient	Measured from T <sub>MIN</sub> to T <sub>MAX</sub>		50		nA/°C
PSRR	Power Supply Rejection Ratio	V <sub>S</sub> = +2.7V to +12V	55	70		dB
CMRR	Common Mode Rejection Ratio	V <sub>CM</sub> = 0V to +3.8V	55	65		dB
		V <sub>CM</sub> = 0V to +3.0V	55	70		dB
CMIR	Common Mode Input Range		0		V <sub>S</sub> -1.2	V
R <sub>IN</sub>	Input Resistance	Common Mode	1	2		MΩ
C <sub>IN</sub>	Input Capacitance	SO Package		1		pF
		PDIP Package		1.5		pF
R <sub>OUT</sub>	Output Resistance	A <sub>V</sub> = +1		40		mΩ
I <sub>S</sub>	Supply Current (per amplifier)	V <sub>S</sub> = +12V		5	6.5	mA
PSOR	Power Supply Operating Range		2.7		12.0	V

### DC Electrical Characteristics

V<sub>S</sub> = +5V, GND = 0V, T<sub>A</sub> = 25°C, V<sub>CM</sub> = +1.5V, V<sub>OUT</sub> = +1.5V, unless otherwise specified.

Parameter	Description	Test Conditions	Min	Typ	Max	Unit
AVOL	Open Loop Gain	V <sub>S</sub> = +12V, V <sub>OUT</sub> = +2V to +9V, R <sub>L</sub> = 1kΩ to GND	60	80		dB
		V <sub>OUT</sub> = +1.5V to +3.5V, R <sub>L</sub> = 1kΩ to GND		70		dB
		V <sub>OUT</sub> = +1.5V to +3.5V, R <sub>L</sub> = 150Ω to GND		60		dB
V <sub>OP</sub>	Positive Output Voltage Swing	V <sub>S</sub> = +12V, A <sub>V</sub> = +1, R <sub>L</sub> = 1kΩ to 0V		10.8		V
		V <sub>S</sub> = +12V, A <sub>V</sub> = +1, R <sub>L</sub> = 150Ω to 0V	9.6	10.0		V
		V <sub>S</sub> = ±5V, A <sub>V</sub> = +1, R <sub>L</sub> = 1kΩ to 0V		4.0		V
		V <sub>S</sub> = ±5V, A <sub>V</sub> = +1, R <sub>L</sub> = 150Ω to 0V	3.4	3.8		V
		V <sub>S</sub> = +3V, A <sub>V</sub> = +1, R <sub>L</sub> = 150Ω to 0V	1.8	1.95		V

# EL2250C, EL2450C

## 125MHz Single Supply Dual/Quad Op Amps

EL2250C, EL2450C

### DC Electrical Characteristics

$V_S = +5V$ ,  $GND = 0V$ ,  $T_A = 25^\circ C$ ,  $V_{CM} = +1.5V$ ,  $V_{OUT} = +1.5V$ , unless otherwise specified.

Parameter	Description	Test Conditions	Min	Typ	Max	Unit
$V_{ON}$	Negative Output Voltage Swing	$V_S = +12V$ , $A_V = +1$ , $R_L = 150\Omega$ to $0V$		5.5	8	mV
		$V_S = \pm 5V$ , $A_V = +1$ , $R_L = 1k\Omega$ to $0V$		-4.0		V
		$V_S = \pm 5V$ , $A_V = +1$ , $R_L = 150\Omega$ to $0V$		-3.7	-3.4	V
$I_{OUT}$	Output Current <sup>[1]</sup>	$V_S = \pm 5V$ , $A_V = +1$ , $R_L = 10\Omega$ to $0V$	$\pm 75$	$\pm 100$		mA
		$V_S = \pm 5V$ , $A_V = +1$ , $R_L = 50\Omega$ to $0V \pm 60V$ mA				

1. Internal short circuit protection circuitry has been built into the EL2250C/EL2450C; see the Applications section

### Closed Loop AC Electrical Characteristics

$V_S = +5V$ ,  $GND = 0V$ ,  $T_A = 25^\circ C$ ,  $V_{CM} = +1.5V$ ,  $V_{OUT} = +1.5V$ ,  $A_V = +1$ ,  $R_F = 0\Omega$ ,  $R_L = 150\Omega$  to  $GND$  pin, unless otherwise specified.<sup>[1]</sup>

Parameter	Description	Test Conditions	Min	Typ	Max	Unit
BW	-3dB Bandwidth ( $V_{OUT} = 400mV_{p-p}$ )	$V_S = +5V$ , $A_V = +1$ , $R_F = 0\Omega$		125		MHz
		$V_S = +5V$ , $A_V = -1$ , $R_F = 500\Omega$		60		MHz
		$V_S = +5V$ , $A_V = +2$ , $R_F = 500\Omega$		60		MHz
		$V_S = +5V$ , $A_V = +10$ , $R_F = 500\Omega$		6		MHz
		$V_S = +12V$ , $A_V = +1$ , $R_F = 0\Omega$		150		MHz
		$V_S = +3V$ , $A_V = +1$ , $R_F = 0\Omega$		100		MHz
BW	$\pm 0.1dB$ Bandwidth ( $V_{OUT} = 400mV_{p-p}$ )	$V_S = +12V$ , $A_V = +1$ , $R_F = 0\Omega$		25		MHz
		$V_S = +5V$ , $A_V = +1$ , $R_F = 0\Omega$		30		MHz
		$V_S = +3V$ , $A_V = +1$ , $R_F = 0\Omega$		20		MHz
GBWP	Gain Bandwidth Product	$V_S = +12V$ , @ $A_V = +10$		60		MHz
PM	Phase Margin	$R_L = 1k\Omega$ , $C_L = 6pF$		55		°
SR	Slew Rate	$V_S = +10V$ , $R_L = 150\Omega$ , $V_{OUT} = 0V$ to $+6V$	200	275		V/ $\mu s$
		$V_S = +5V$ , $R_L = 150\Omega$ , $V_{OUT} = 0V$ to $+3V$		300		V/ $\mu s$
$t_R$ , $t_F$	Rise Time, Fall Time	$\pm 0.1V$ Step		2.8		ns
OS	Overshoot	$\pm 0.1V$ Step		10		%
$t_{PD}$	Propagation Delay	$\pm 0.1V$ Step		3.2		ns
$t_S$	0.1% Settling Time	$V_S = \pm 5V$ , $R_L = 500\Omega$ , $A_V = +1$ , $V_{OUT} = \pm 3V$		40		ns
	0.01% Settling Time	$V_S = \pm 5V$ , $R_L = 500\Omega$ , $A_V = +1$ , $V_{OUT} = \pm 3V$		75		ns
dG	Differential Gain <sup>[2]</sup>	$A_V = +2$ , $R_F = 1k\Omega$		0.05		%
dP	Differential Phase <sup>[2]</sup>	$A_V = +2$ , $R_F = 1k\Omega$		0.05		°
$e_N$	Input Noise Voltage	$f = 10kHz$		48		nV/ $\sqrt{Hz}$
$i_N$	Input Noise Current	$f = 10kHz$		1.25		pA/ $\sqrt{Hz}$

1. All AC tests are performed on a "warmed up" part, except slew rate, which is pulse tested

2. Standard NTSC signal = 286mV<sub>p-p</sub>,  $f = 3.58MHz$ , as  $V_{IN}$  is swept from 0.6V to 1.314V;  $R_L$  is DC coupled

# EL2250C, EL2450C

125MHz Single Supply Dual/Quad Op Amps

## Typical Performance Curves

**Non-Inverting Frequency Response (Gain)**

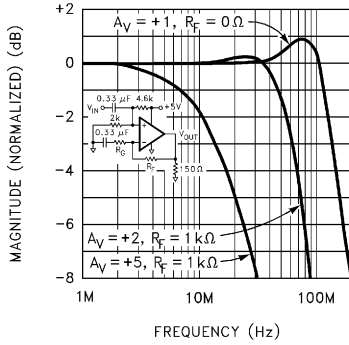

**Non-Inverting Frequency Response (Phase)**

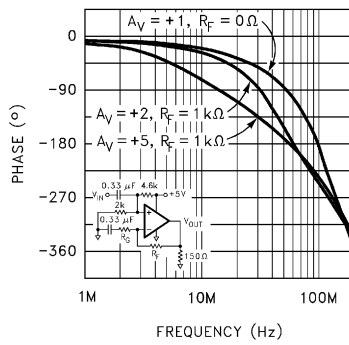

**3dB Bandwidth vs Temperature for Non-Inverting Gains**

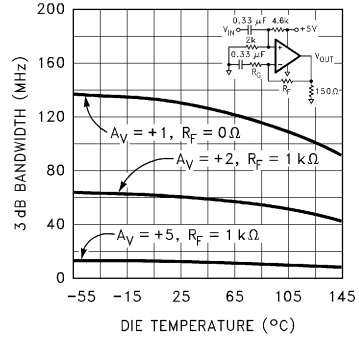

**Inverting Frequency Response (Gain)**

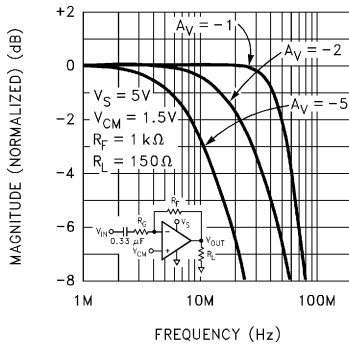

**Inverting Frequency Response (Phase)**

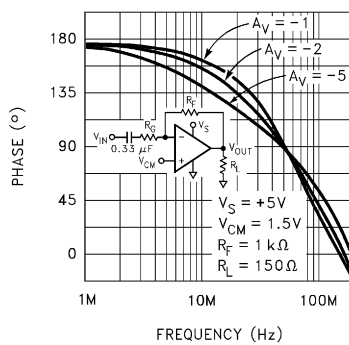

**3dB Bandwidth vs Temperature for Inverting Gains**

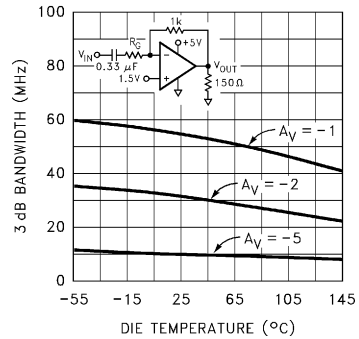

**Frequency Response for Various  $R_L$**

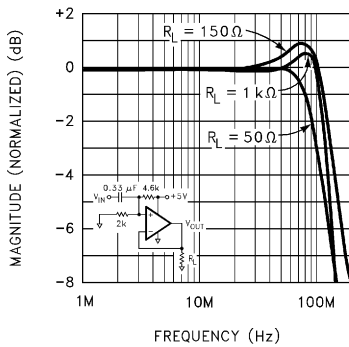

**Frequency Response for Various  $C_L$**

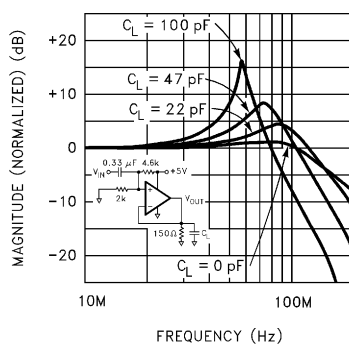

**Non-Inverting Frequency Response vs Common Mode Voltage**

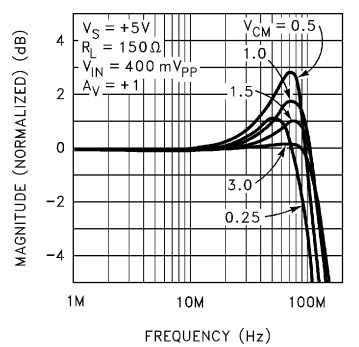

# EL2250C, EL2450C

## 125MHz Single Supply Dual/Quad Op Amps

EL2250C, EL2450C

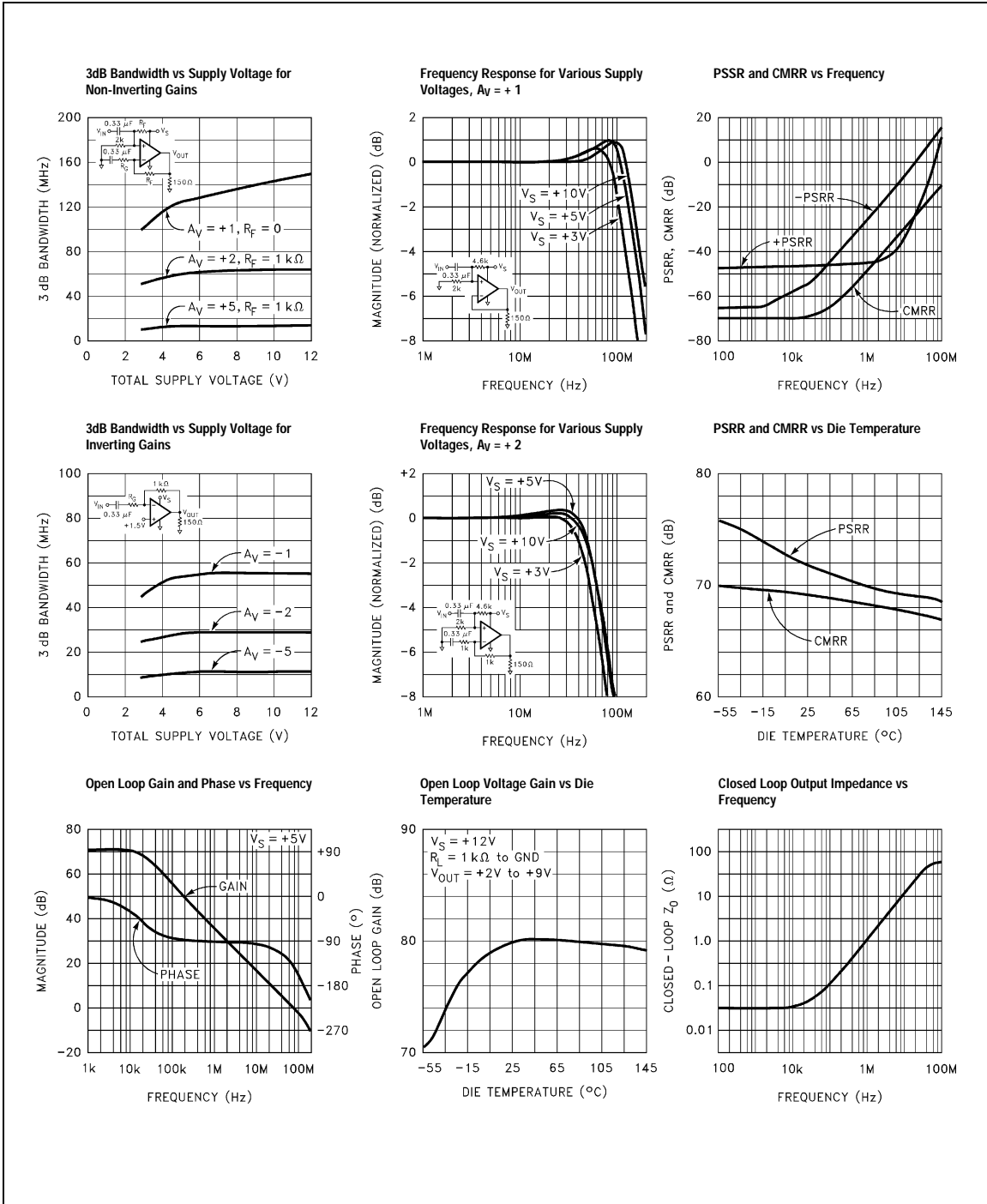

# EL2250C, EL2450C

125MHz Single Supply Dual/Quad Op Amps

Large Signal Step Response,  $V_S = +3V$

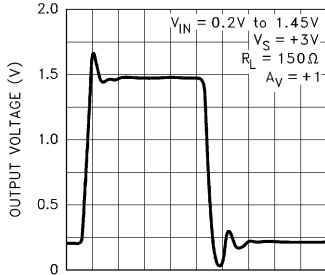

TIME 20 ns/div

Large Signal Step Response,  $V_S = +5V$

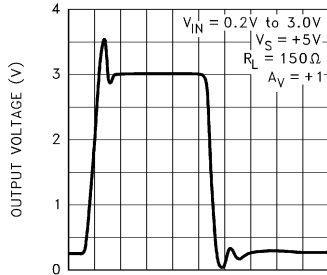

TIME 20 ns/div

Large Signal Step Response,  $V_S = +12V$

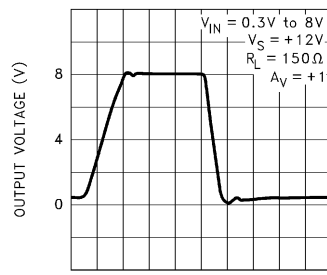

TIME 20 ns/div

Small Signal Step Response

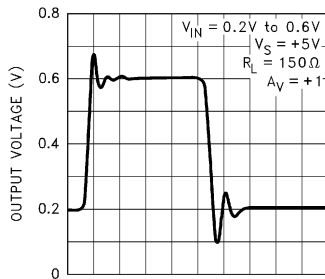

TIME 20 ns/div

Large Signal Step Response,  $V_S = \pm 5V$

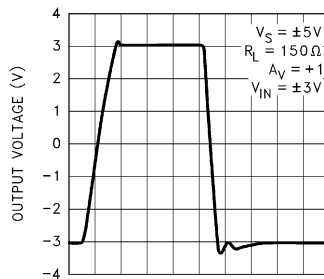

TIME 20 ns/div

Slew Rate vs Temperature

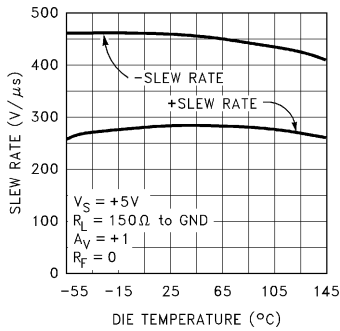

Settling Time vs Settling Accuracy

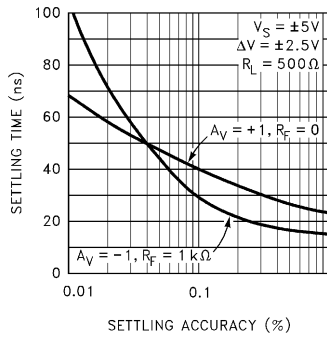

Voltage and Current Noise vs Frequency

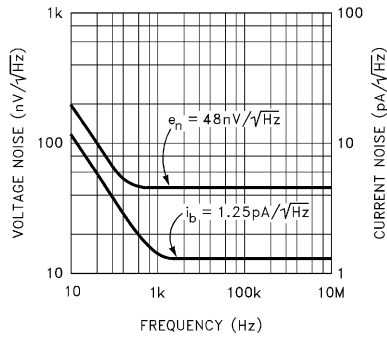

# EL2250C, EL2450C

## 125MHz Single Supply Dual/Quad Op Amps

EL2250C, EL2450C

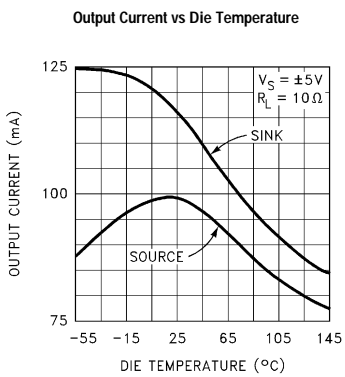
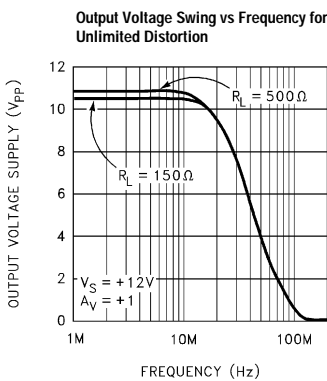
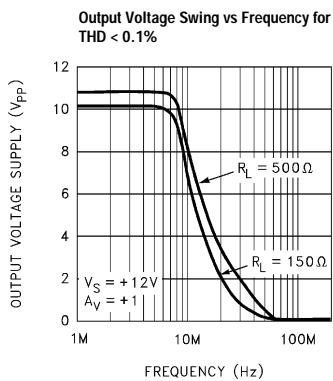
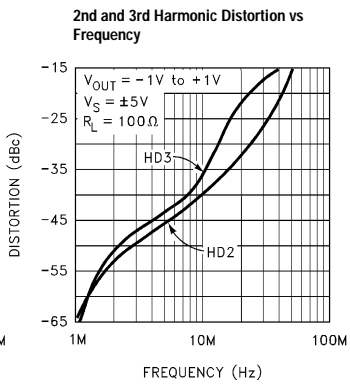
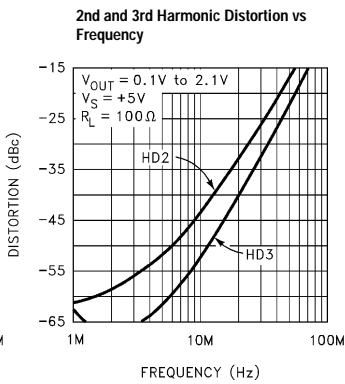
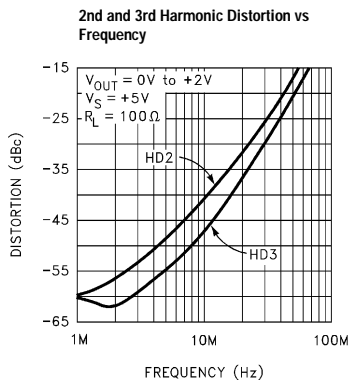
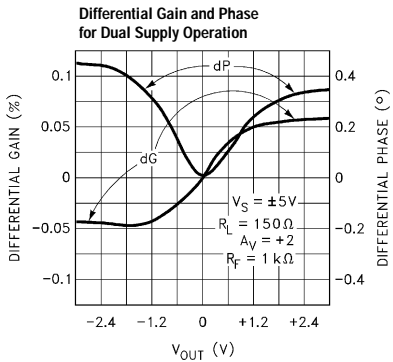
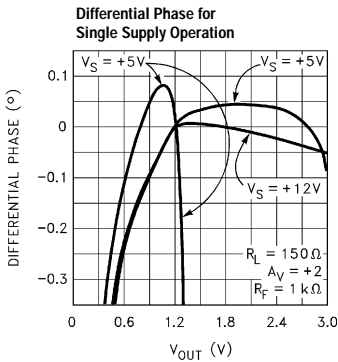
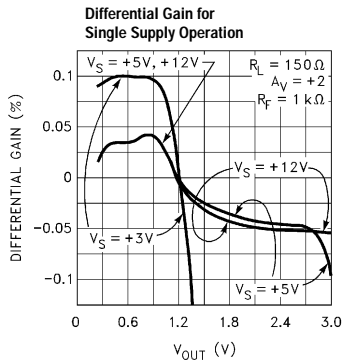

# EL2250C, EL2450C

## 125MHz Single Supply Dual/Quad Op Amps

Supply Current vs Supply Voltage (per amplifier)

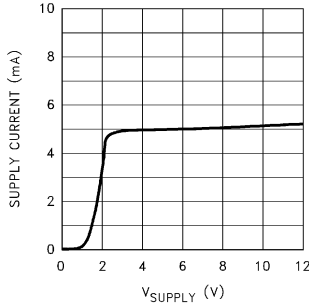

Supply Current vs Die Temperature (per amplifier)

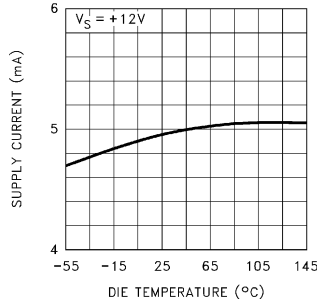

Input Resistance vs Die Temperature

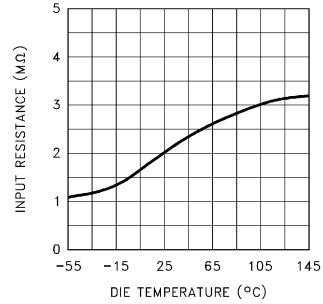

Offset Voltage vs Die Temperature (4 Samples)

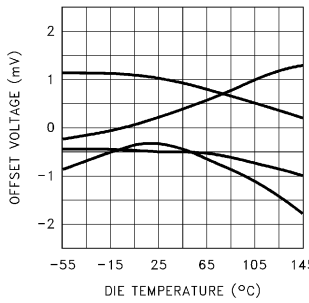

Input Bias Current vs Input Voltage

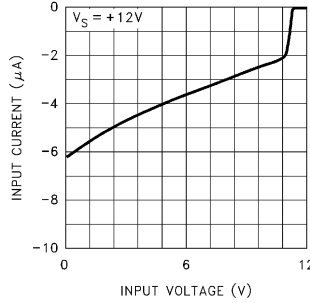

Input Offset Current and Input Bias Current vs Die Temperature

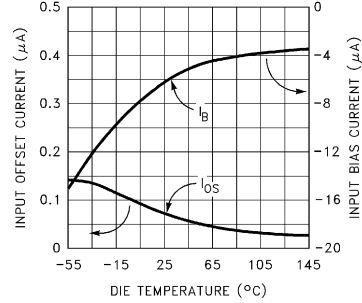

Positive Output Voltage Swing vs Die Temperature, R\_L = 150Ω to GND

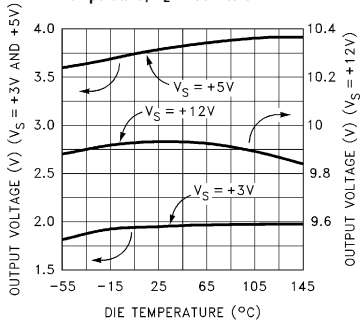

Negative Output Voltage Swing vs Die Temperature, R\_L = 150Ω to GND

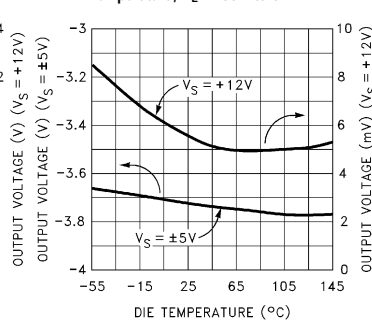

Channel to Channel Isolation vs Frequency

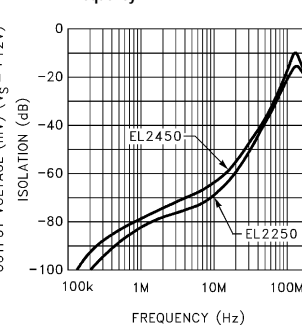



# EL2250C, EL2450C

## 125MHz Single Supply Dual/Quad Op Amps

EL2250C, EL2450C

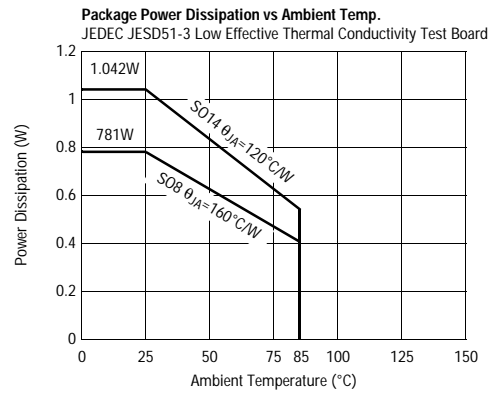
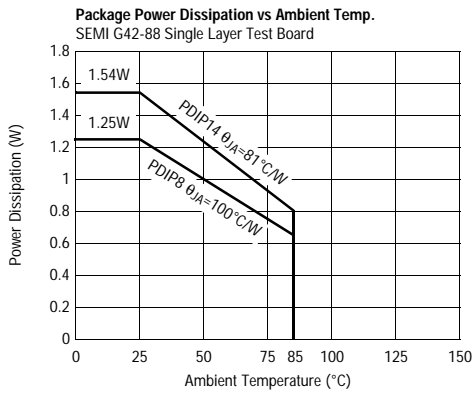

### Simplified Schematic

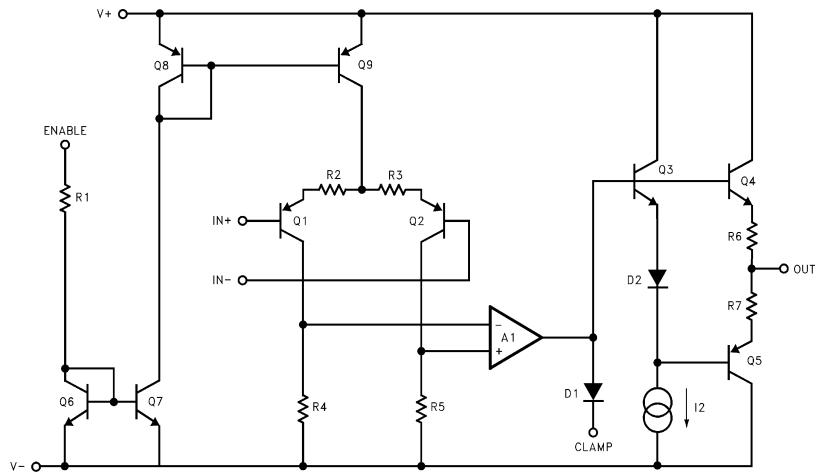

# EL2250C, EL2450C

125MHz Single Supply Dual/Quad Op Amps

## Applications Information

### Product Description

The EL2250C/EL2450C are part of a family of the industries fastest single supply operational amplifiers. Connected in voltage follower mode, their -3dB bandwidth is 125MHz while maintaining a 275 V/ $\mu$ s slew rate. With an input and output common mode range that includes ground, these amplifiers were optimized for single supply operation, but will also accept dual supplies. They operate on a total supply voltage range as low as +2.7V or up to +12V. This makes them ideal for +3V applications, especially portable computers.

While many amplifiers claim to operate on a single supply, and some can sense ground at their inputs, most fail to truly drive their outputs to ground. If they do succeed in driving to ground, the amplifier often saturates, causing distortion and recovery delays. However, special circuitry built into the EL2250C/EL2450C allows the output to follow the input signal to ground without recovery delays.

### Power Supply Bypassing And Printed Circuit Board Layout

As with any high-frequency device, good printed circuit board layout is necessary for optimum performance. Ground plane construction is highly recommended. Lead lengths should be as short as possible. The power supply pins must be well bypassed to reduce the risk of oscillation. The combination of a 4.7 $\mu$ F tantalum capacitor in parallel with a 0.1  $\mu$ F ceramic capacitor has been shown to work well when placed at each supply pin. For single supply operation, where the GND pin is connected to the ground plane, a single 4.7 $\mu$ F tantalum capacitor in parallel with a 0.1 $\mu$ F ceramic capacitor across the  $V_{S+}$  and GND pins will suffice.

For good AC performance, parasitic capacitance should be kept to a minimum. Ground plane construction should be used. Carbon or Metal-Film resistors are acceptable with the Metal-Film resistors giving slightly less peaking and bandwidth because of their additional series inductance. Use of sockets, particularly for the SO package should be avoided if possible. Sockets add parasitic inductance and capacitance which will result in some additional peaking and overshoot.

### Supply Voltage Range and Single-Supply Operation

The EL2250C/EL2450C have been designed to operate with supply voltages having a span of greater than 2.7V, and less than 12V. In practical terms, this means that the EL2250C/EL2450C will operate on dual supplies ranging from  $\pm 1.35V$  to  $\pm 6V$ . With a single-supply, the EL2250C/EL2450C will operate from +2.7V to +12V. Performance has been optimized for a single +5V supply.

Pins 8 and 4 are the power supply pins on the EL2250C. The positive power supply is connected to pin 8. When used in single supply mode, pin 4 is connected to ground. When used in dual supply mode, the negative power supply is connected to pin 4.

Pins 4 and 11 are the power supply pins on the EL2450C. The positive power supply is connected to pin 4. When used in single supply mode, pin 11 is connected to ground. When used in dual supply mode, the negative power supply is connected to pin 11.

As supply voltages continue to decrease, it becomes necessary to provide input and output voltage ranges that can get as close as possible to the supply voltages. The EL2250C/EL2450C have an input voltage range that includes the negative supply and extends to within 1.2V of the positive supply. So, for example, on a single +5V supply, the EL2250C/EL2450C have an input range which spans from 0V to 3.8V.

The output range of the EL2250C/EL2450C is also quite large. It includes the negative rail, and extends to within 1V of the top supply rail with a 1k $\Omega$  load. On a +5V supply, the output is therefore capable of swinging from 0V to +4V. On split supplies, the output will swing  $\pm 4V$ . If the load resistor is tied to the negative rail and split supplies are used, the output range is extended to the negative rail.

### Choice Of Feedback Resistor, $R_F$

The feedback resistor forms a pole with the input capacitance. As this pole becomes larger, phase margin is reduced. This increases ringing in the time domain and peaking in the frequency domain. Therefore,  $R_F$  has

# **EL2250C, EL2450C**

## **125MHz Single Supply Dual/Quad Op Amps**

EL2250C, EL2450C

some maximum value which should not be exceeded for optimum performance. If a large value of  $R_F$  must be used, a small capacitor in the few picofarad range in parallel with  $R_F$  can help to reduce this ringing and peaking at the expense of reducing the bandwidth.

As far as the output stage of the amplifier is concerned,  $R_F + R_G$  appear in parallel with  $R_L$  for gains other than +1. As this combination gets smaller, the bandwidth falls off. Consequently,  $R_F$  has a minimum value that should not be exceeded for optimum performance.

For  $A_V = +1$ ,  $R_F = 0\Omega$  is optimum. For  $A_V = -1$  or +2 (noise gain of 2), optimum response is obtained with  $R_F$  between  $500\Omega$  and  $1k\Omega$ . For  $A_V = -4$  or +5 (noise gain of 5), keep  $R_F$  between  $2k\Omega$  and  $10k\Omega$ .

### **Video Performance**

For good video performance, an amplifier is required to maintain the same output impedance and the same frequency response as DC levels are changed at the output. This can be difficult when driving a standard video load of  $150\Omega$ , because of the change in output current with DC level. Differential Gain and Differential Phase for the EL2250C/EL2450C are specified with the black level of the output video signal set to +1.2V. This allows ample room for the sync pulse even in a gain of +2 configuration. This results in dG and dP specifications of 0.05% and  $0.05^\circ$  while driving  $150\Omega$  at a gain of +2. Setting the black level to other values, although acceptable, will compromise peak performance. For example, looking at the single supply dG and dP curves for  $R_L=150\Omega$ , if the output black level clamp is reduced from 1.2V to 0.6V dG/dP will increase from 0.05%/ $0.05^\circ$  to 0.08%/ $0.25^\circ$ . Note that in a gain of +2 configuration, this is the lowest black level allowed such that the sync tip doesn't go below 0V.

If your application requires that the output goes to ground, then the output stage of the EL2250C/EL2450C, like all other single supply op amps, requires an external pull down resistor tied to ground. As mentioned above, the current flowing through this resistor becomes the DC bias current for the output stage NPN transistor. As this

current approaches zero, the NPN turns off, and dG and dP will increase. This becomes more critical as the load resistor is increased in value. While driving a light load, such as  $1k\Omega$ , if the input black level is kept above 1.25V, dG and dP are a respectable 0.03% and  $0.03^\circ$ .

For other biasing conditions see the Differential Gain and Differential Phase vs. Input Voltage curves.

### **Output Drive Capability**

In spite of their moderately low 5mA of supply current, the EL2250C/EL2450C are capable of providing  $\pm 100mA$  of output current into a  $10\Omega$  load, or  $\pm 60mA$  into  $50\Omega$ . With this large output current capability, a  $50\Omega$  load can be driven to  $\pm 3V$  with  $V_S = \pm 5V$ , making it an excellent choice for driving isolation transformers in telecommunications applications.

### **Driving Cables and Capacitive Loads**

When used as a cable driver, double termination is always recommended for reflection-free performance. For those applications, the back-termination series resistor will de-couple the EL2250C/EL2450C from the cable and allow extensive capacitive drive. However, other applications may have high capacitive loads without a back-termination resistor. In these applications, a small series resistor (usually between  $5\Omega$  and  $50\Omega$ ) can be placed in series with the output to eliminate most peaking. The gain resistor ( $R_G$ ) can then be chosen to make up for any gain loss which may be created by this additional resistor at the output.

### **Video Sync Pulse Remover Application**

All CMOS Analog to Digital Converters (A/Ds) have a parasitic latch-up problem when subjected to negative input voltage levels. Since the sync tip contains no useful video information and it is a negative going pulse, we can chop it off.

Figure 1 shows a unity gain connected amplifier A of an EL2250C. Figure 2 shows the complete input video signal applied at the input, as well as the output signal with the negative going sync pulse removed.

**EL2250C, EL2450C**

125MHz Single Supply Dual/Quad Op Amps

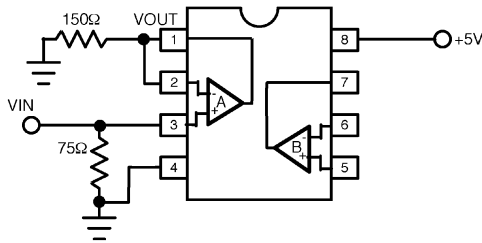

Figure 1.

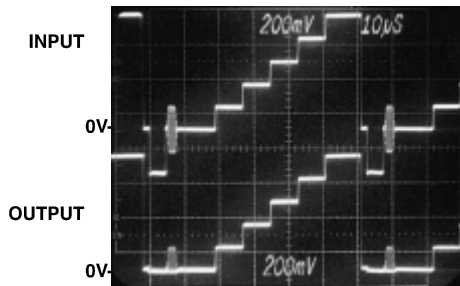

Figure 2.

**Short Circuit Current Limit**

The EL2250C/EL2450C have internal short circuit protection circuitry that protect it in the event of its output being shorted to either supply rail. This limit is set to around 100mA nominally and reduces with increasing junction temperature. It is intended to handle temporary shorts. If an output is shorted indefinitely, the power dissipation could easily increase such that the part will be destroyed. Maximum reliability is maintained if the output current never exceeds  $\pm 90\text{mA}$ . A heat sink may be required to keep the junction temperature below absolute maximum when an output is shorted indefinitely.

**Power Dissipation**

With the high output drive capability of the EL2250C/EL2450C, it is possible to exceed the  $150^\circ\text{C}$  Absolute Maximum junction temperature under certain load current conditions. Therefore, it is important to calculate the maximum junction temperature for the application to determine if power-supply voltages, load

conditions, or package type need to be modified for the EL2250C/EL2450C to remain in the safe operating area.

The maximum power dissipation allowed in a package is determined according to [1]:

$$PD_{MAX} = \frac{T_{JMAX} - T_{AMAX}}{\theta_{JA}}$$

where:

$T_{JMAX}$  = Maximum Junction Temperature

$T_{AMAX}$  = Maximum Ambient Temperature

$\theta_{JA}$  = Thermal Resistance of the Package

$PD_{MAX}$  = Maximum Power Dissipation in the Package.

The maximum power dissipation actually produced by an IC is the total quiescent supply current times the total power supply voltage, plus the power in the IC due to the load, or [2]

$$PD_{MAX} = N \times \left( V_S \times I_{SMAX} + (V_S - V_{OUT}) \times \frac{V_{OUT}}{R_L} \right)$$

where:

$N$  = Number of amplifiers

$V_S$  = Total Supply Voltage

$I_{SMAX}$  = Maximum Supply Current per amplifier

$V_{OUT}$  = Maximum Output Voltage of the Application

$R_L$  = Load Resistance tied to Ground

If we set the two  $PD_{MAX}$  equations, [1] & [2], equal to each other, and solve for  $V_S$ , we can get a family of curves for various loads and output voltages according to [3]:

$$V_S = \frac{\frac{R_L \times (T_{JMAX} - T_{AMAX})}{N \times \theta_{JA}} + (V_{OUT})}{(IS \times R_L) + V_{OUT}}$$

***EL2250C, EL2450C***  
*125MHz Single Supply Dual/Quad Op Amps*

EL2250C, EL2450C

Figures 3 through 6 below show total single supply voltage  $V_S$  vs.  $R_L$  for various output voltage swings for the PDIP and SO packages. The curves assume WORST

CASE conditions of  $T_A = +85^\circ\text{C}$  and  $I_S = 6.5\text{mA}$  per amplifier.

# EL2250C, EL2450C

125MHz Single Supply Dual/Quad Op Amps

EL2250C Single Supply Voltage vs  $R_{LOAD}$  for Various  $V_{OUT}$  (PDIP Package)

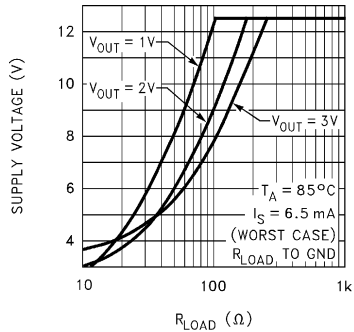

Figure 3.

EL2450C Single Supply Voltage vs  $R_{LOAD}$  for Various  $V_{OUT}$  (PDIP Package)

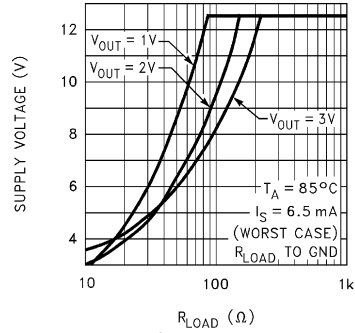

Figure 5.

EL2250C Single Supply Voltage vs  $R_{LOAD}$  for Various  $V_{OUT}$  (SO Package)

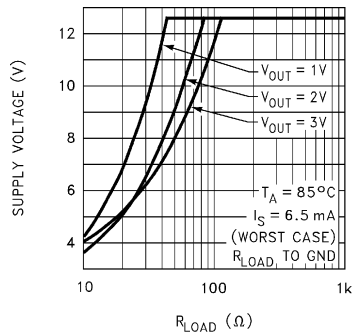

Figure 4.

EL2450C Single Supply Voltage vs  $R_{LOAD}$  for Various  $V_{OUT}$  (SO Package)

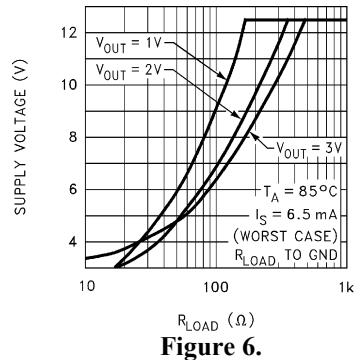

Figure 6.

# *EL2250C, EL2450C*

*125MHz Single Supply Dual/Quad Op Amps*

EL2250C, EL2450C

## EL2250C/EL2450C Macromodel (one amplifier)

```

* Revision A, April 1996
* Pin numbers reflect a standard single op amp.
* Connections:
*      +input
*      |
*      | -input
*      |
*      | | +Vsupply
*      | | |
*      | | | -Vsupply
*      | | |
*      | | | output
.subckt EL2250/el 3 2 7 4 6
*
* Input Stage
*
i1 7 10 250uA
i2 7 11 250uA
r1 10 11 4k
q1 12 2 10 qp
q2 13 3 11 qpa
r2 12 4 100
r3 13 4 100
*
* Second Stage & Compensation
*
gm 15 4 13 12 4.6m
r4 15 4 15Meg
c1 15 4 0.36pF
*
* Poles
*
e1 17 4 15 4 1.0
r6 17 25 400
c3 25 4 1pF
r7 25 18 500
c4 18 4 1pF
*
* Output Stage
*
i3 20 4 1.0mA
q3 7 23 20 qn
q4 7 18 19 qn
q5 7 18 21 qn
q6 4 20 22 qp
q7 7 23 18 qn
d1 19 20 da
r8 21 6 2
r9 22 6 2
r10 18 21 10k
r11 7 23 100k
d2 23 24 da
d3 24 4 da
d4 23 18 da
*
* Power Supply Current
*
ips 7 4 3.2mA
*
* Models
*
.model qn npn(is=800e-18 bf=150 tf=0.02nS)
.model qpa pnp(is=810e-18 bf=50 tf=0.02nS)
.model qp pnp(is=800e-18 bf=54 tf=0.02nS)
.model da d(tt=0nS)
.ends

```

**EL2250C, EL2450C**  
 125MHz Single Supply Dual/Quad Op Amps

**EL2250C/EL2450C Macromodel (one amplifier)**

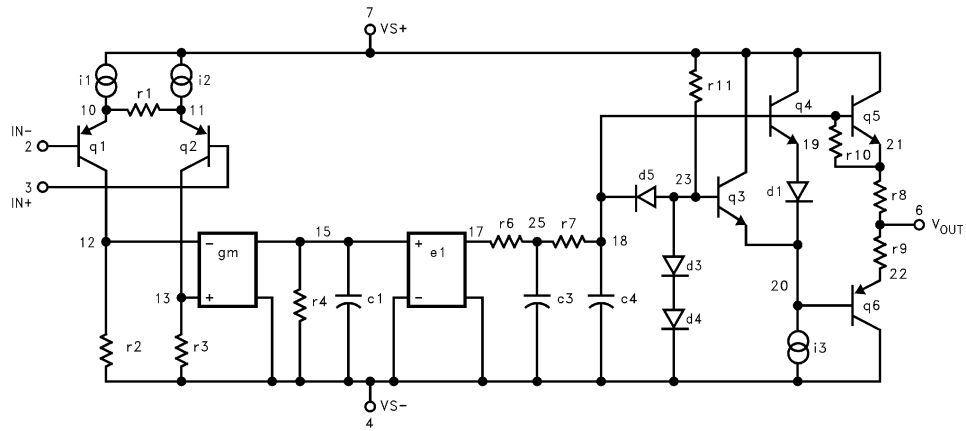



# ***EL2250C, EL2450C***

*125MHz Single Supply Dual/Quad Op Amps*

## **General Disclaimer**

Specifications contained in this data sheet are in effect as of the publication date shown. Elantec, Inc. reserves the right to make changes in the circuitry or specifications contained herein at any time without notice. Elantec, Inc. assumes no responsibility for the use of any circuits described herein and makes no representations that they are free from patent infringement.

***élantec***

HIGH PERFORMANCE ANALOG INTEGRATED CIRCUITS

## **Elantec Semiconductor, Inc.**

675 Trade Zone Blvd.

Milpitas, CA 95035

Telephone: (408) 945-1323

(888) ELANTEC

Fax: (408) 945-9305

European Office: +44-118-977-6020

Japan Technical Center: +81-45-682-5820

## **WARNING - Life Support Policy**

Elantec, Inc. products are not authorized for and should not be used within Life Support Systems without the specific written consent of Elantec, Inc. Life Support systems are equipment intended to support or sustain life and whose failure to perform when properly used in accordance with instructions provided can be reasonably expected to result in significant personal injury or death. Users contemplating application of Elantec, Inc. Products in Life Support Systems are requested to contact Elantec, Inc. factory headquarters to establish suitable terms & conditions for these applications. Elantec, Inc.'s warranty is limited to replacement of defective components and does not cover injury to persons or property or other consequential damages.