

LM615 Quad Comparator and Adjustable Reference

General Description

The comparators have an input range which extends to the negative supply, and have open-collector outputs. Improved over the LM139 series, the input stages of the comparators have lateral PNP input transistors which enable low input currents for large differential input voltages and swings above V^+ .

The voltage reference is a three-terminal shunt-type band-gap, and is referred to the V^- terminal. Two resistors program the reference from 1.24V to 6.3V, with accuracy of $\pm 0.6\%$ available. The reference features operation over a shunt current range of $17 \mu\text{A}$ to 20 mA, low dynamic impedance, broad capacitive load range, and cathode terminal voltage ranging from a diode-drop below V^- to above V^+ .

As a member of National's Super-Block™ family, the LM615 is a space-saving monolithic alternative to a multi-chip solution, offering a high level of integration without sacrificing performance.

Features

COMPARATORS

- Low operating current 600 μA
- Wide supply voltage range 4V to 36V
- Open-collector outputs
- Input common-mode range V^- to $(V^+ - 1.8\text{V})$
- Wide differential input voltage $\pm 36\text{V}$

REFERENCE

- Adjustable output voltage 1.24V to 6.3V
- Tight initial tolerance available $\pm 0.6\%$ (25°C)
- Wide operating current range 17 μA to 20 mA
- Tolerant of load capacitance

Applications

- Adjustable threshold detector
- Time-delay generator
- Voltage window comparator
- Power supply monitor
- RGB level detector

Connection Diagram

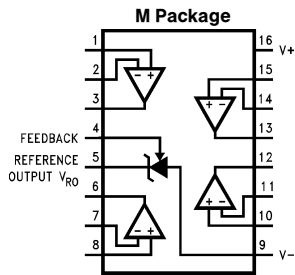

Top View

TL/H/11057-24

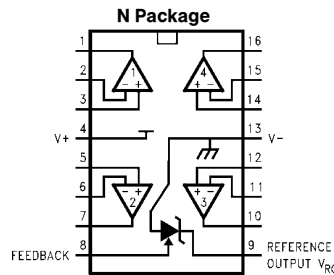

Top View

TL/H/11057-1

Ordering Information

For information about surface-mount packaging of this device, please contact the Analog Product Marketing group at National Semiconductor Corp. headquarters.

| Reference Tolerances | Temperature Range | | Package | NSC Package Number |
|--|--|---|-----------------------------|--------------------|
| | Military $-55^\circ\text{C} \leq T_J \leq +125^\circ\text{C}$ | Industrial $-40^\circ\text{C} \leq T_J \leq +85^\circ\text{C}$ | | |
| $\pm 0.6\%$ at 25°C, 80 ppm/°C max | LM615AMN | LM615AIN | 16-Pin Molded DIP | N16A |
| | LM615AMJ/883 (Note 13) | | 16-Pin Ceramic DIP | J16A |
| $\pm 2.0\%$ at 25°C, 150 ppm/°C max | LM615MN | LM615IN | 16-Pin Molded DIP | N16A |
| | | LM615IM | 16-Pin Narrow Surface Mount | M16A |

Super-Block™ is a trademark of National Semiconductor Corporation.

Absolute Maximum Ratings (Note 1)

If Military/Aerospace specified devices are required, please contact the National Semiconductor Sales Office/Distributors for availability and specifications.

Voltage on Any Pin Except V_{RO}
(referred to $V-$ pin)

(Note 2) 36V (Max)
(Note 3) -0.3V (Min)

Current through Any Input Pin
and V_{RO} Pin ± 20 mA

Differential Input Voltage ± 36 V

Output Short-Circuit Duration (Note 4)

Storage Temperature Range $-65^{\circ}\text{C} \leq T_J \leq +150^{\circ}\text{C}$

Maximum Junction Temperature 150°C

Thermal Resistance, Junction-to-Ambient (Note 5)
N Package $95^{\circ}\text{C}/\text{W}$

Soldering Information

N Package Soldering (10 seconds) 260°C

ESD Tolerance (Note 6) ± 1 kV

Operating Temperature Range

LM615AI, LM615I $-40^{\circ}\text{C} \leq T_J \leq +85^{\circ}\text{C}$

LM615A, LM615M $-55^{\circ}\text{C} \leq T_J \leq +125^{\circ}\text{C}$

Electrical Characteristics

These specifications apply for $V^- = \text{GND} = 0\text{V}$, $V^+ = 5\text{V}$, $V_{CM} = V_{OUT} = V^+ / 2$, $I_R = 100 \mu\text{A}$, FEEDBACK pin shorted to GND, unless otherwise specified. Limits in standard typeface are for $T_J = 25^{\circ}\text{C}$; limits in **boldface type** apply over the

Operating Temperature Range.

| Symbol | Parameter | Conditions | Typical (Note 7) | LM615AM LM615AI Limits (Note 8) | LM615M LM615I Limits (Note 8) | Units |
|----------------------------------|---------------------------------------|---|---------------------|--|--|--|
| COMPARATORS | | | | | | |
| I_S | Total Supply Current | V^+ Current, $R_{LOAD} = \infty$, $3\text{V} \leq V^+ \leq 36\text{V}$ | 250 350 | 550 600 | 600 650 | μA max μA max |
| V_{OS} | Offset Voltage over V^+ Range | $4\text{V} \leq V^+ \leq 36\text{V}$, $R_L = 15 \text{ k}\Omega$ | 1.0 2.0 | 3.0 6.0 | 5.0 7.0 | mV max mV max |
| V_{OS} | Offset Voltage over V_{CM} Range | $0\text{V} \leq V_{CM} \leq (V^+ - 1.8\text{V})$ $V^+ = 30\text{V}$, $R_L = 15 \text{ k}\Omega$ | 1.0 1.5 | 3.0 6.0 | 5.0 7.0 | mV max mV max |
| $\frac{\Delta V_{OS}}{\Delta T}$ | Average Offset Voltage Drift | | 15 | | | $\mu\text{V}/^{\circ}\text{C}$ |
| I_B | Input Bias Current | | -5 -8 | 25 30 | 35 40 | nA max nA max |
| I_{OS} | Input Offset Current | | 0.2 0.3 | 4 5 | 4 5 | nA max nA max |
| A_V | Voltage Gain | $R_L = 10 \text{ k}\Omega$ to 36V , $2\text{V} \leq V_{OUT} \leq 27\text{V}$ | 500 100 | 50 | 50 | V/mV min V/mV |
| t_R | Large Signal Response Time | $V_{+IN} = 1.4\text{V}$, $V_{-IN} = \text{TTL}$ Swing, $R_L = 5.1 \text{ k}\Omega$ | 1.5 2.0 | | | μs μs |
| I_{SINK} | Output Sink Current | $V_{+IN} = 0\text{V}$, $V_{-IN} = 1\text{V}$, $V_{OUT} = 1.5\text{V}$ $V_{OUT} = 0.4\text{V}$ | 20 13 | 10 8 | 10 8 | mA min mA min |
| I_L | Output Leakage Current | $V_{+IN} = 1\text{V}$, $V_{-IN} = 0\text{V}$, $V_{OUT} = 36\text{V}$ | 0.1 0.2 | 10 | 10 | μA max μA |

Electrical Characteristics

These specifications apply for $V^- = \text{GND} = 0\text{V}$, $V^+ = 5\text{V}$, $V_{\text{CM}} = V_{\text{OUT}} = V^+/2$, $I_{\text{R}} = 100 \mu\text{A}$, FEEDBACK pin shorted to GND, unless otherwise specified. Limits in standard typeface are for $T_{\text{J}} = 25^\circ\text{C}$; limits in **boldface type** apply over the **Operating Temperature Range**. (Continued)

| Symbol | Parameter | Conditions | Typical (Note 7) | LM615AM LM615AI Limits (Note 8) | LM615M LM615I Limits (Note 8) | Units |
|--|--|---|--|--|--|--------------------------------------|
| VOLTAGE REFERENCE (Note 9) | | | | | | |
| V_{R} | Reference Voltage | | 1.244 | 1.2365 1.2515 ($\pm 0.6\%$) | 1.2191 1.2689 ($\pm 2\%$) | V min V max |
| $\frac{\Delta V_{\text{R}}}{\Delta T}$ | Average Drift with Temperature | (Note 10) | 18 | 80 | 150 | ppm/ $^\circ\text{C}$ max |
| $\frac{\Delta V_{\text{R}}}{\text{kH}}$ | Average Drift with Time | $T_{\text{J}} = 40^\circ\text{C}$ $T_{\text{J}} = 150^\circ\text{C}$ | 400 1000 | | | ppm/kH ppm/kH |
| $\frac{\Delta V_{\text{R}}}{\Delta T_{\text{J}}}$ | Hysteresis | (Note 11) | 3.2 | | | $\mu\text{V}/^\circ\text{C}$ |
| $\frac{\Delta V_{\text{R}}}{\Delta I_{\text{R}}}$ | V_{R} Change with Current | $V_{\text{R}[100 \mu\text{A}]} - V_{\text{R}[17 \mu\text{A}]}$ $V_{\text{R}[10 \text{mA}]} - V_{\text{R}[100 \mu\text{A}]}$ (Note 12) | 0.05 0.1 1.5 2.0 | 1 1.1 5 5.5 | 1 1.1 5 5.5 | mV max mV max mV max mV max |
| R | Resistance | $\Delta V_{\text{R}[10 \text{mA to } 0.1 \text{mA}]} / 9.9 \text{mA}$ $\Delta V_{\text{R}[100 \mu\text{A to } 17 \mu\text{A}]} / 83 \mu\text{A}$ | 0.2 0.6 | 0.56 13 | 0.56 13 | Ω max Ω max |
| $\frac{\Delta V_{\text{R}}}{\Delta V_{\text{RO}}}$ | V_{R} Change with V_{RO} | $V_{\text{R}[V_{\text{RO}} = V_{\text{R}}]} - V_{\text{R}[V_{\text{RO}} = 6.3\text{V}]}$ | 2.5 2.8 | 5 10 | 5 10 | mV max mV max |
| $\frac{\Delta V_{\text{R}}}{\Delta V^+}$ | V_{R} Change with V^+ Change | $V_{\text{R}[V^+ = 5\text{V}]} - V_{\text{R}[V^+ = 36\text{V}]}$ $V_{\text{R}[V^+ = 5\text{V}]} - V_{\text{R}[V^+ = 3\text{V}]}$ | 0.1 0.1 0.01 0.01 | 1.2 1.3 1 1.5 | 1.2 1.3 1 1.5 | mV max mV max mV max mV max |
| I_{FB} | FEEDBACK Bias Current | $V^- \leq V_{\text{FB}} \leq 5.06\text{V}$ | 22 29 | 35 40 | 50 55 | nA max nA max |
| e_{n} | Voltage Noise | BW = 10 Hz to 10 kHz | 30 | | | μV_{RMS} |

Note 1: Absolute maximum ratings indicate limits beyond which damage to the component may occur. Electrical specifications do not apply when operating the device beyond its rated operating conditions.

Note 2: Input voltage above V^+ is allowed. As long as one input pin voltage remains inside the common-mode range, the comparator will deliver the correct output.

Note 3: More accurately, it is excessive current flow, with resulting excess heating, that limits the voltages on all pins. When any pin is pulled a diode drop below V^- , a parasitic NPN transistor turns ON. No latch-up will occur as long as the current through that pin remains below the Maximum Rating. Operation is undefined and unpredictable when any parasitic diode or transistor is conducting.

Note 4: Shorting an Output to V^- will not cause power dissipation, so it may be continuous. However, shorting an Output to any more positive voltage (including V^+), will cause 80 mA (typ.) to be drawn through the output transistor. This current multiplied by the applied voltage is the power dissipation in the output transistor. If the total power from all shorted outputs causes the junction temperature to exceed 150°C , degraded reliability or destruction of the device may occur. To determine junction temperature, see Note 5.

Note 5: Junction temperature may be calculated using $T_{\text{J}} = T_{\text{A}} + P_{\text{D}} \theta_{\text{JA}}$. The given thermal resistance is worst-case for packages in sockets in still air. For packages soldered to copper-clad board with dissipation from one comparator or reference output transistor, nominal θ_{JA} is $80^\circ\text{C}/\text{W}$ for the N package.

Note 6: Human body model, 100 pF discharge through a 1.5 k Ω resistor.

Note 7: Typical values in standard typeface are for $T_{\text{J}} = 25^\circ\text{C}$; values in **boldface type** apply for the full operating temperature range. These values represent the most likely parametric norm.

Note 8: All limits are guaranteed for $T_{\text{J}} = +25^\circ\text{C}$ (standard type face) or over the full operating temperature range (**bold type face**).

Note 9: V_{RO} is the reference output voltage, which may be set for 1.2V to 6.3V (see Application Information). V_{R} is the V_{RO} -to-FEEDBACK voltage (nominally 1.244V).

Note 10: Average reference drift is calculated from the measurement of the reference voltage at 25°C and at the temperature extremes. The drift, in ppm/ $^\circ\text{C}$, is $10^6 \cdot \Delta V_{\text{R}} / V_{\text{R}[25^\circ\text{C}]} \cdot \Delta T_{\text{J}}$, where ΔV_{R} is the lowest value subtracted from the highest, $V_{\text{R}[25^\circ\text{C}]}$ is the value at 25°C , and ΔT_{J} is the temperature range. This parameter is guaranteed by design and sample testing.

Note 11: Hysteresis is the change in V_{RO} caused by a change in T_{J} , after the reference has been "dehysteresized." To dehysteresize the reference; that is minimize the hysteresis to the typical value, its junction temperature should be cycled in the following pattern, spiraling in toward 25°C : 25°C , 85°C , -40°C , 70°C , 0°C , 25°C .

Note 12: Low contact resistance is required for accurate measurement.

Note 13: A military RETS electrical test specification is available on request. The LM615AMJ/883 may also be procured as a Standard Military Drawing.

Simplified Schematic Diagrams

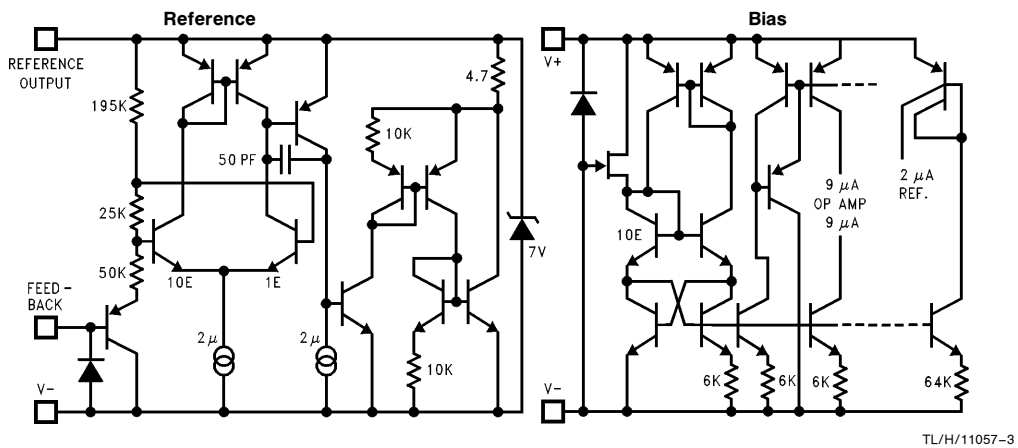
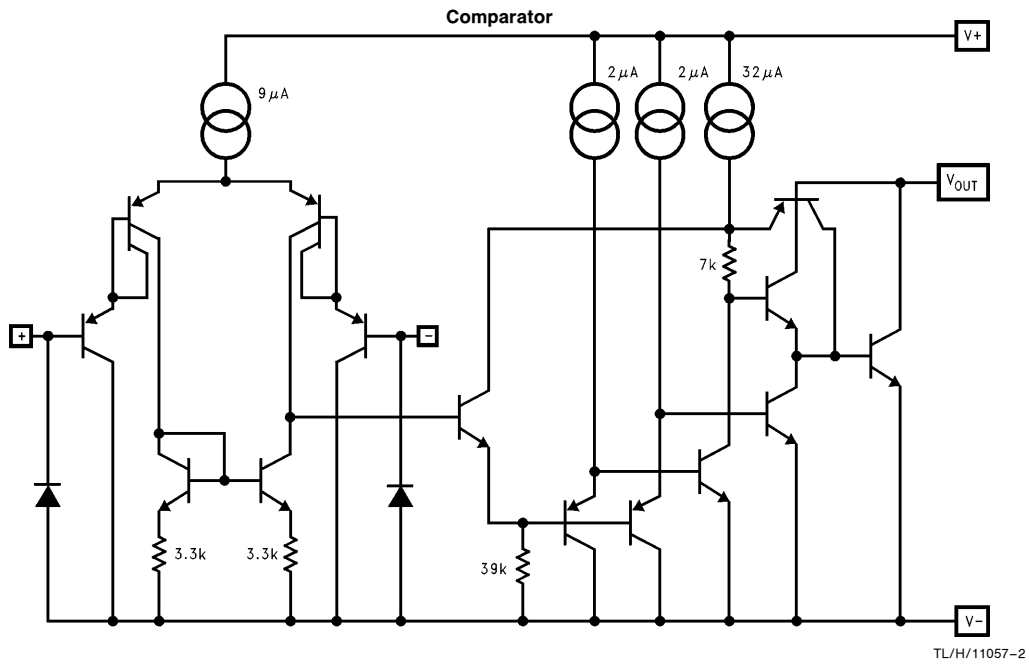

Typical Performance Characteristics (Reference)

$T_J = 25^\circ\text{C}$, FEEDBACK pin shorted to $V^- = 0\text{V}$, unless otherwise noted.

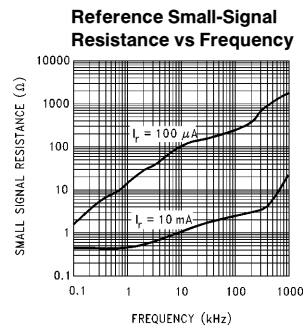
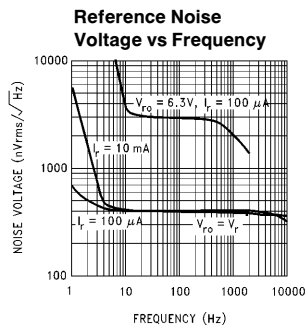
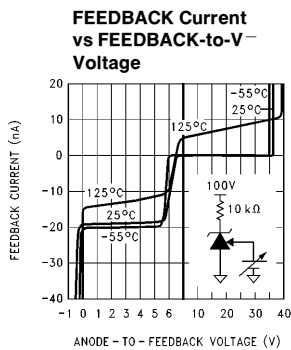
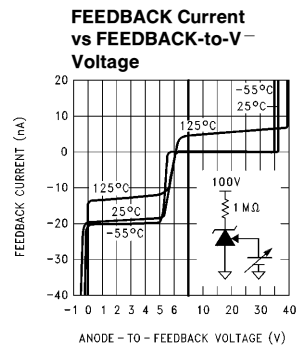
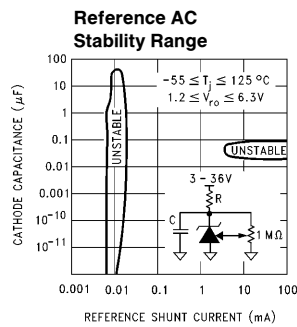
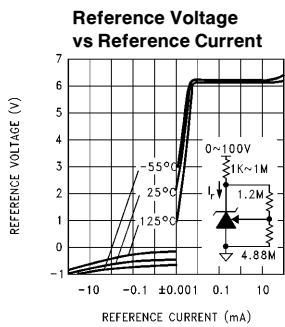
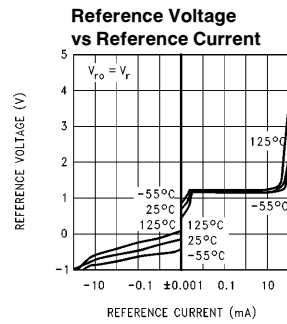
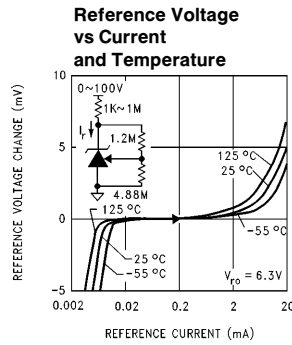
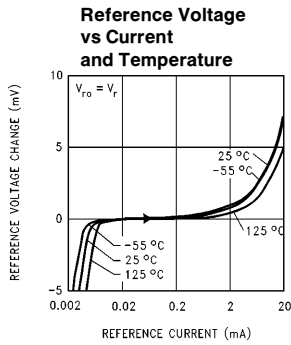
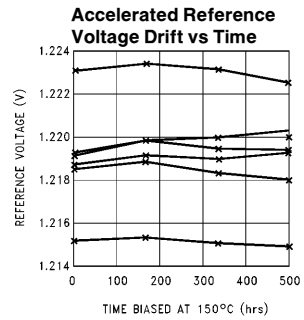
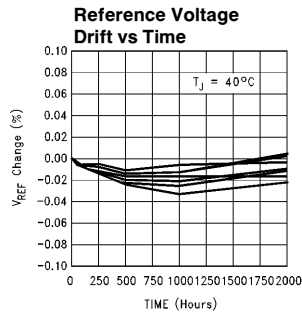
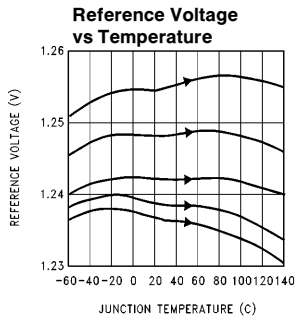

TL/H/11057-4

Typical Performance Characteristics (Reference) (Continued)

$T_J = 25^\circ\text{C}$, FEEDBACK pin shorted to $V^- = 0\text{V}$, unless otherwise noted.

Reference Power-Up Time

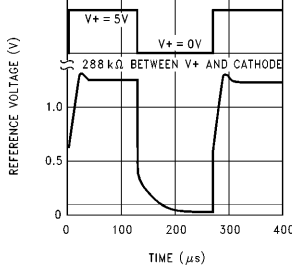

Reference Voltage with FEEDBACK Voltage Step

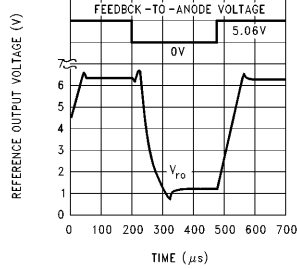

Reference Voltage with $100 \sim 12\ \mu\text{A}$ Current Step

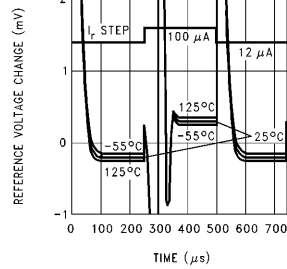

Reference Step Response for $100\ \mu\text{A} \sim 10\text{ mA}$ Current Step

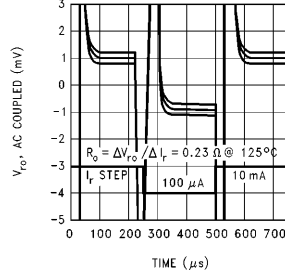

Reference Voltage Change with Supply Voltage Step

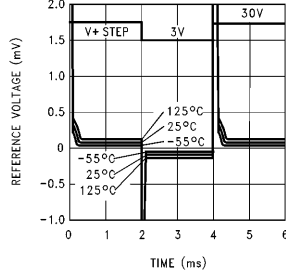

TL/H/11057-5

Typical Performance Characteristics (Comparators)

$T_J = 25^\circ\text{C}$, $V^+ = 5\text{V}$, $V^- = 0\text{V}$, unless otherwise noted

Supply Current vs Supply Voltage

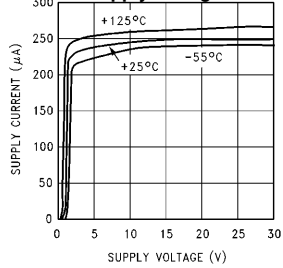

Input-Bias Current vs Common-Mode Voltage

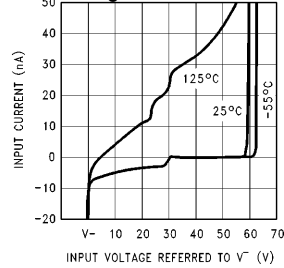

Input Current vs Differential Input Voltage

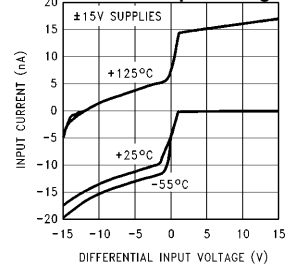

TL/H/11057-6

Typical Performance Characteristics (Comparators) (Continued)

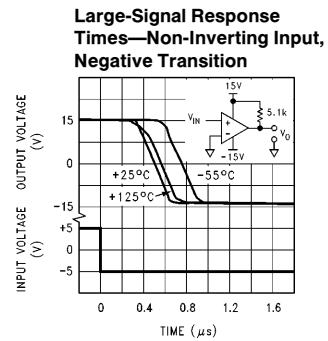
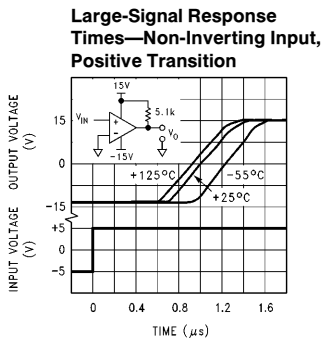
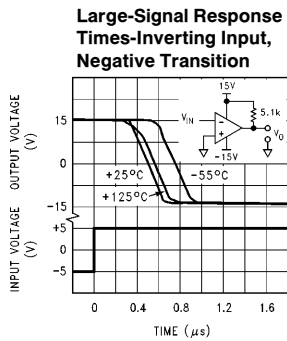
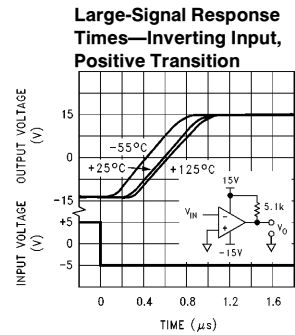
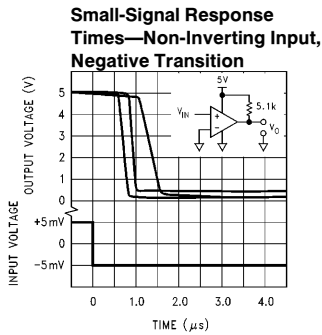
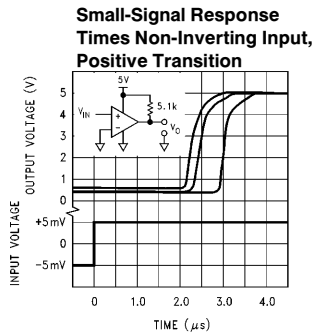
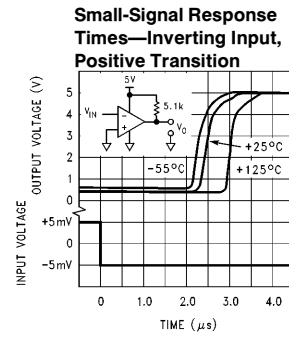
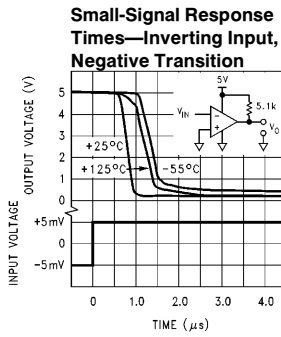
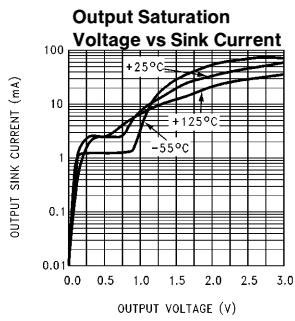

TL/H/11057-8

Application Information

VOLTAGE REFERENCE

Reference Biasing

The voltage reference is of a shunt regulator topology that models as a simple zener diode. With current I_r flowing in the "forward" direction there is the familiar diode transfer function. I_r flowing in the reverse direction forces the reference voltage to be developed from cathode to anode. The cathode may swing from a diode drop below V^- to the reference voltage or to the avalanche voltage of the parallel protection diode, nominally 7V. A 6.3V reference with $V^+ = 3V$ is allowed.

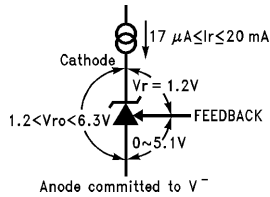

TL/H/11057-9

FIGURE 1. Voltage Associated with Reference (Current Source I_r is External)

The reference equivalent circuit reveals how V_r is held at the constant 1.2V by feedback, and how the FEEDBACK pin passes little current.

To generate the required reverse current, typically a resistor is connected from a supply voltage higher than the reference voltage. Varying that voltage, and so varying I_r , has small effect with the equivalent series resistance of less than an ohm at the higher currents. Alternatively, an active current source, such as the LM134 series, may generate I_r .

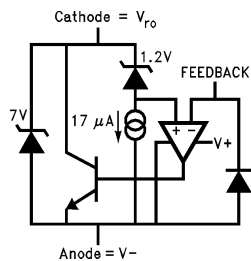

TL/H/11057-10

FIGURE 2. Reference Equivalent Circuit

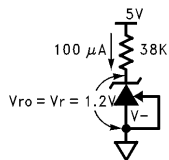

TL/H/11057-11

FIGURE 3. 1.2V Reference

Capacitors in parallel with the reference are allowed. See the Reference AC Stability Range typical curve for capacitance values—from 20 μA to 3 mA any capacitor value is stable. With the reference's wide stability range with resistive and capacitive loads, a wide range of RC filter values will perform noise filtering.

Adjustable Reference

The FEEDBACK pin allows the reference output voltage, V_{ro} , to vary from 1.24V to 6.3V. The reference attempts to hold V_r at 1.24V. If V_r is above 1.24V, the reference will conduct current from Cathode to Anode; FEEDBACK current always remains low. If FEEDBACK is connected to Anode, then $V_{ro} = V_r = 1.24V$. For higher voltages FEEDBACK is held at a constant voltage above Anode—say 3.76V for $V_{ro} = 5V$. Connecting a resistor across the constant V_r generates a current $I = R1/V_r$ flowing from Cathode into FEEDBACK node. A Thevenin equivalent 3.76V is generated from FEEDBACK to Anode with $R2 = 3.76/I$. Keep I greater than one thousand times larger than FEEDBACK bias current for $<0.1\%$ error— $I \geq 32 \mu\text{A}$ for the military grade over the military temperature range ($I \geq 5.5 \mu\text{A}$ for a 1% untrimmed error for an industrial temperature range part).

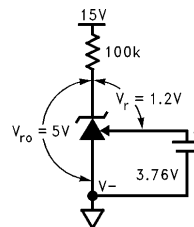

TL/H/11057-12

FIGURE 4. Thevenin Equivalent of Reference with 5V Output

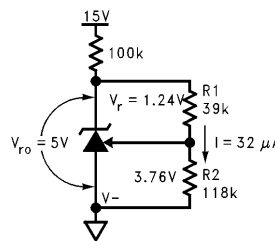

TL/H/11057-13

$$R1 = V_r/I = 1.24/32\mu = 39k$$

$$R2 = R1 [(V_{ro}/V_r) - 1] = 39k [(5/1.24) - 1] = 118k$$

FIGURE 5. Resistors R1 and R2 Program Reference Output Voltage to be 5V

Application Information (Continued)

Understanding that V_f is fixed and that voltage sources, resistors, and capacitors may be tied to the FEEDBACK pin, a range of V_f temperature coefficients may be synthesized.

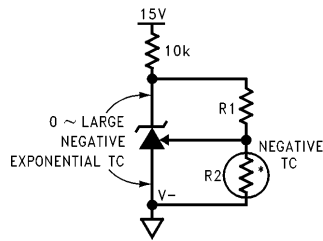

TL/H/11057-14

FIGURE 6. Output Voltage has Negative Temperature Coefficient (TC) if R2 has Negative TC

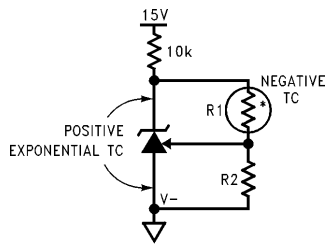

TL/H/11057-15

FIGURE 7. Output Voltage has Positive TC if R1 has Negative TC

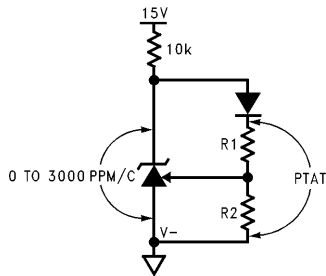

TL/H/11057-16

FIGURE 8. Diode in Series with R1 Causes Voltage Across R1 and R2 to be Proportional to Absolute Temperature (PTAT)

Connecting a resistor across V_{RD} -to-FEEDBACK creates a 0 TC current source, but a range of TCs may be synthesized.

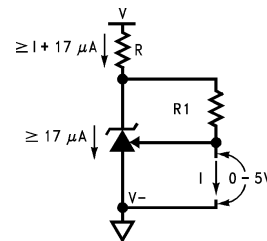

TL/H/11057-17

$$I = V_f/R1 = 1.24/R1$$

FIGURE 9. Current Source is Programmed by R1

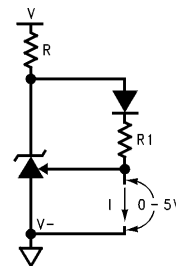

TL/H/11057-18

FIGURE 10. Proportional-to-Absolute-Temperature Current Source

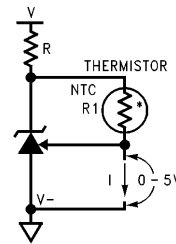

TL/H/11057-19

FIGURE 11. Negative-TC Current Source

Reference Hysteresis

The reference voltage depends, slightly, on the thermal history of the die. Competitive micro-power products vary—always check the data sheet for any given device. Do not assume that no specification means no hysteresis.

Application Information (Continued)

COMPARATORS

Any of the comparators or the reference may be biased in any way with no effect on the other sections of the LM615, except when a substrate diode conducts (see Electrical Characteristics Note 3). For example, one or both inputs of one comparator may be outside the input voltage range limits, the reference may be unpowered, and the other comparators will still operate correctly. Unused comparators should have inverting input and output tied to V^- , and non-inverting input tied to V^+ .

Hysteresis

Any comparator may oscillate or produce a noisy output if the applied differential input voltage is near the comparator's offset voltage. This usually happens when the input signal is moving very slowly across the comparator's switching threshold. This problem can be prevented by the addition of hysteresis, or positive feedback, as shown in *Figure 12*.

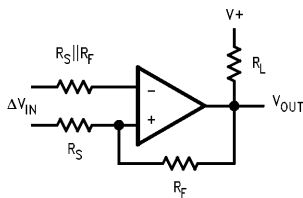

TL/H/11057-20

FIGURE 12. R_S and R_F Add Hysteresis to Comparator

The amount of hysteresis added in *Figure 12* is

$$V_H = V^+ \times \frac{R_S}{(R_F + R_S)}$$

$$\approx V^+ \times \frac{R_S}{R_F} \quad \text{for } R_F \gg R_S$$

A good rule of thumb is to add hysteresis of at least the maximum specified offset voltage. More than about 50 mV of hysteresis can substantially reduce the accuracy of the comparator, since the offset voltage is effectively being increased by the hysteresis when the comparator output is high.

It is often a good idea to decrease the amount of hysteresis until oscillations are observed, then use three times that minimum hysteresis in the final circuit. Note that the amount of hysteresis needed is greatly affected by layout. The amount of hysteresis should be rechecked each time the layout is changed, such as changing from a breadboard to a P.C. board.

Input Stage

The input stage uses lateral PNP input transistors which, unlike those of many op amps, have breakdown voltage BV_{EBO} equal to the absolute maximum supply voltage. Also, they have no diode clamps to the positive supply nor across the inputs. These features make the inputs look like high impedances to input sources producing large differential and common-mode voltages.

The guaranteed common-mode input voltage range for an LM615 is $V^- \leq V_{CM} \leq (V^+ - 1.8V)$, over temperature. This is the voltage range in which the comparisons must be made. If both inputs are within this range, the output will be at the correct state. If one input is within this range, and the other input is less than $(V^- + 32V)$, even if this is greater than V^+ , the output will be at the correct state. If, however, either or both inputs are driven below V^- , and either input current exceeds $10 \mu A$, the output state is not guaranteed to be correct. If both inputs are above $(V^+ - 1.8V)$, the output state is also not guaranteed to be correct.

Output Stage

The comparators have open-collector output stages which require a pull-up resistor from each output pin to a positive supply voltage of the output to switch properly. When the internal output transistor is off, the output (HIGH) voltage will be pulled up to this external positive voltage.

To ensure that the LOW output voltage is under the TTL-low threshold, the output transistor's load current must be less than 0.8 mA (over temperature) when it turns on. This impacts the minimum value of the pull-up resistor.

Typical Applications

Power Supply Monitor

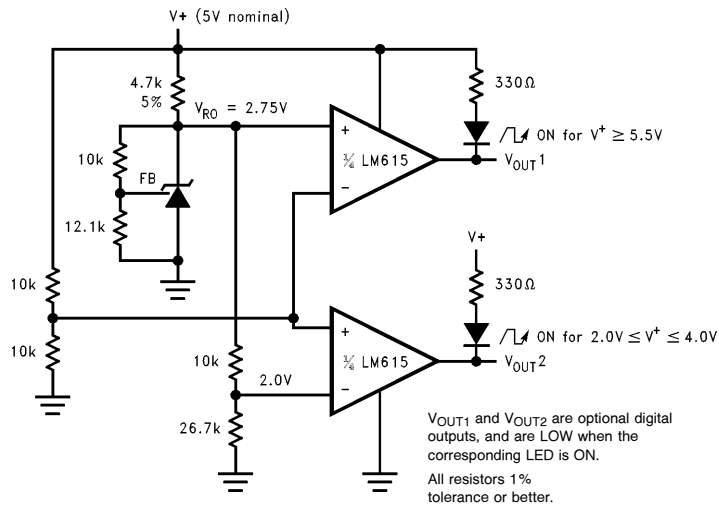

TL/H/11057-21

Tracking Comparator

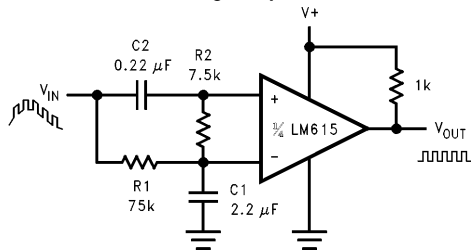

TL/H/11057-22

R1-C1 removes the low-frequency signal component, so that through R2-C2 the higher-frequency component is detected.

4-Threshold Level Detector

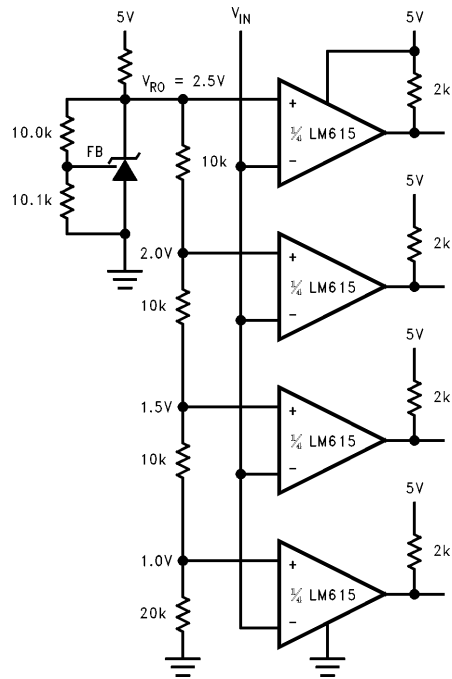

TL/H/11057-23



Physical Dimensions inches (millimeters)

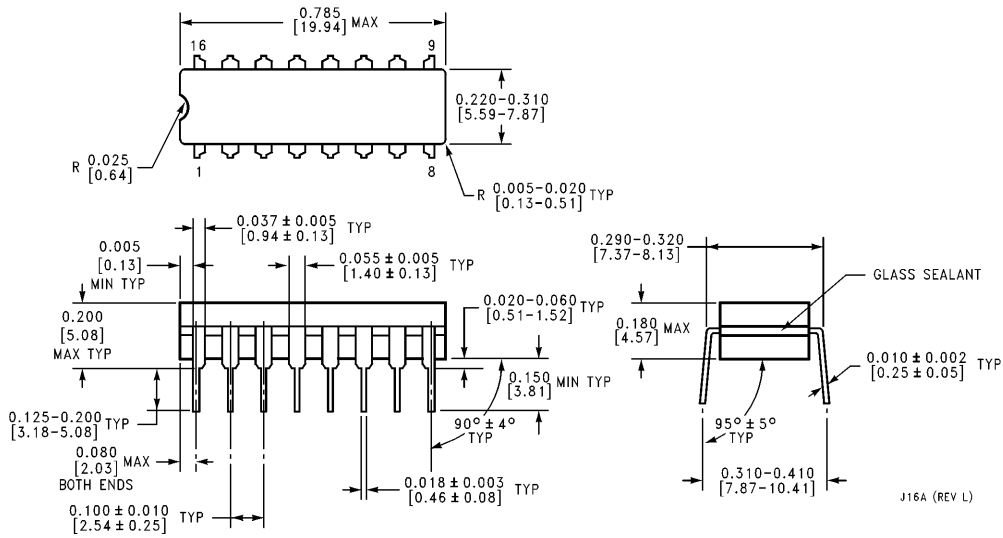

Ceramic Dual-In-Line Package (J)
Order Number LM615AMJ/883
NS Package Number J16A

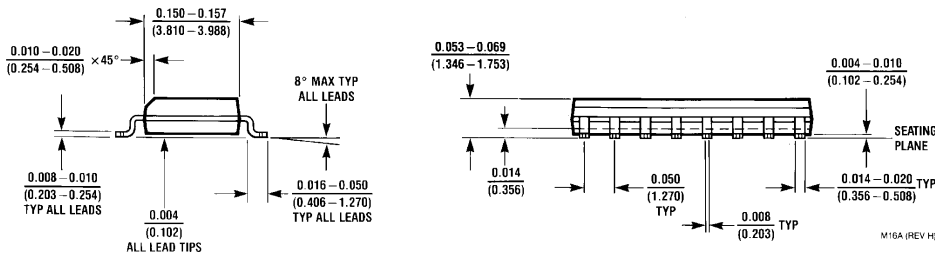
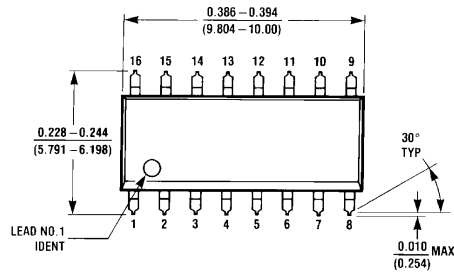

16-Pin Narrow Surface Mount Package (M)
Order Number LM615IM
NS Package Number M16A

Physical Dimensions inches (millimeters) (Continued)

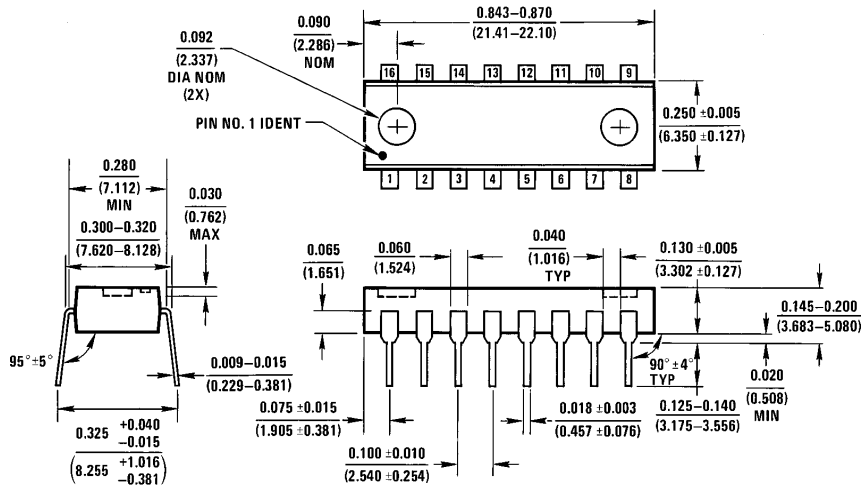

16-Pin Molded Dual-In-Line Package (N)
Order Number LM615IN or LM615MN
NS Package Number N16A

N16A (REV E)

LIFE SUPPORT POLICY

NATIONAL'S PRODUCTS ARE NOT AUTHORIZED FOR USE AS CRITICAL COMPONENTS IN LIFE SUPPORT DEVICES OR SYSTEMS WITHOUT THE EXPRESS WRITTEN APPROVAL OF THE PRESIDENT OF NATIONAL SEMICONDUCTOR CORPORATION. As used herein:

1. Life support devices or systems are devices or systems which, (a) are intended for surgical implant into the body, or (b) support or sustain life, and whose failure to perform, when properly used in accordance with instructions for use provided in the labeling, can be reasonably expected to result in a significant injury to the user.
2. A critical component is any component of a life support device or system whose failure to perform can be reasonably expected to cause the failure of the life support device or system, or to affect its safety or effectiveness.



National Semiconductor Corporation
 1111 West Bardin Road
 Arlington, TX 76017
 Tel: 1(800) 272-9959
 Fax: 1(800) 737-7018

National Semiconductor Europe
 Fax: (+49) 0-180-530 85 86
 Email: onjwge@tevm2.nsc.com
 Deutsch Tel: (+49) 0-180-530 85 85
 English Tel: (+49) 0-180-532 78 32
 Français Tel: (+49) 0-180-532 93 58
 Italiano Tel: (+49) 0-180-534 16 80

National Semiconductor Hong Kong Ltd.
 19th Floor, Straight Block,
 Ocean Centre, 5 Canton Rd.
 Tsimshatsui, Kowloon
 Hong Kong
 Tel: (852) 2737-1600
 Fax: (852) 2736-9960

National Semiconductor Japan Ltd.
 Tel: 81-043-299-2309
 Fax: 81-043-299-2408

National does not assume any responsibility for use of any circuitry described, no circuit patent licenses are implied and National reserves the right at any time without notice to change said circuitry and specifications.