

LM4854 Boomer® Audio Power Amplifier Series

1.9W Monaural, 85mW Stereo Headphone Audio Amplifier

General Description

The unity-gain stable LM4854 is both a mono differential output (for bridge-tied loads, or BTL) audio power amplifier and a single-ended (SE) stereo headphone amplifier. Operating on a single 5V supply, the mono BTL mode delivers 1.1W (typ) to an 8Ω load, 1.7W (typ) to a 4Ω load (Note 1) at 1% THD+N. In SE stereo mode, the amplifier will deliver 85mW to 32Ω loads. The LM4854 features a new circuit topology that suppresses output transients ('click and pops') and eliminates SE-mode output coupling capacitors, saving both component and board space costs. The LM4854 has three inputs: one pair for a two-channel stereo signal and the third for a single-channel mono input.

The LM4854 is designed for PDA, cellular telephone, notebook, and other handheld portable applications. It delivers high quality output power from a surface-mount package and requires few external components. Other features include an active-low micropower shutdown mode, an "instant-on" low power standby mode, and thermal shutdown protection.

The LM4854 is available in the very space-efficient 12-lead micro SMD, exposed-DAP LLP for higher power applications, and TSSOP packages.

Note 1: An LM4854LD that has been properly mounted to a circuit board will deliver 1.7W (typ) into a 4Ω load.

Key Specifications

■ LLP BTL output power ($R_L = 3.2\Omega$ and THD+N = 1%)	
$V_{DD} = 3.0V$	1.0W (typ)
$V_{DD} = 5.0V$	1.9W (typ)
■ LLP BTL output power ($R_L = 4\Omega$ and THD+N = 1%)	
$V_{DD} = 3.0V$	900mW (typ)
$V_{DD} = 5.0V$	1.7W (typ)
■ LLP BTL output power ($R_L = 8\Omega$ and THD+N = 1%)	
$V_{DD} = 3.0V$	380mW (typ)
$V_{DD} = 5.0V$	1.1W (typ)

■ SE output power ($R_L = 32\Omega$ and THD+N = 1.0%)	
$V_{DD} = 3.0V$	32mW (typ)
$V_{DD} = 5.0V$	93mW (typ)
■ Micropower shutdown supply current	
$V_{DD} = 3.0V$	0.005μA (typ)
$V_{DD} = 5.0V$	0.05μA (typ)
■ Standby supply current	
$V_{DD} = 3.0V$	16μA (typ)
$V_{DD} = 5.0V$	27μA (typ)
■ PSRR ($f = 1kHz, 3.0V \leq V_{DD} \leq 5.0V$, (Fig. 1))	
BTL	60dB (typ)
SE	66dB (typ)

Features

- Fast 0.1ms (typ) and 1.0ms (max) turn-on and turn-off time
- Eliminates SE amplifier output coupling capacitors
- Advanced "click and pop" suppression circuitry
- Stereo headphone amplifier mode
- Low-power standby and ultra-low current micropower shutdown modes
- Thermal shutdown protection circuitry
- 2.4V to 5.5V operation
- Unity-gain stable
- Gain set with external resistors
- Space-saving micro SMD package, exposed-DAP LLP, and TSSOP

Applications

- PDAs
- Notebook computers
- Cellular phones
- Handheld portable electronic devices

Typical Application

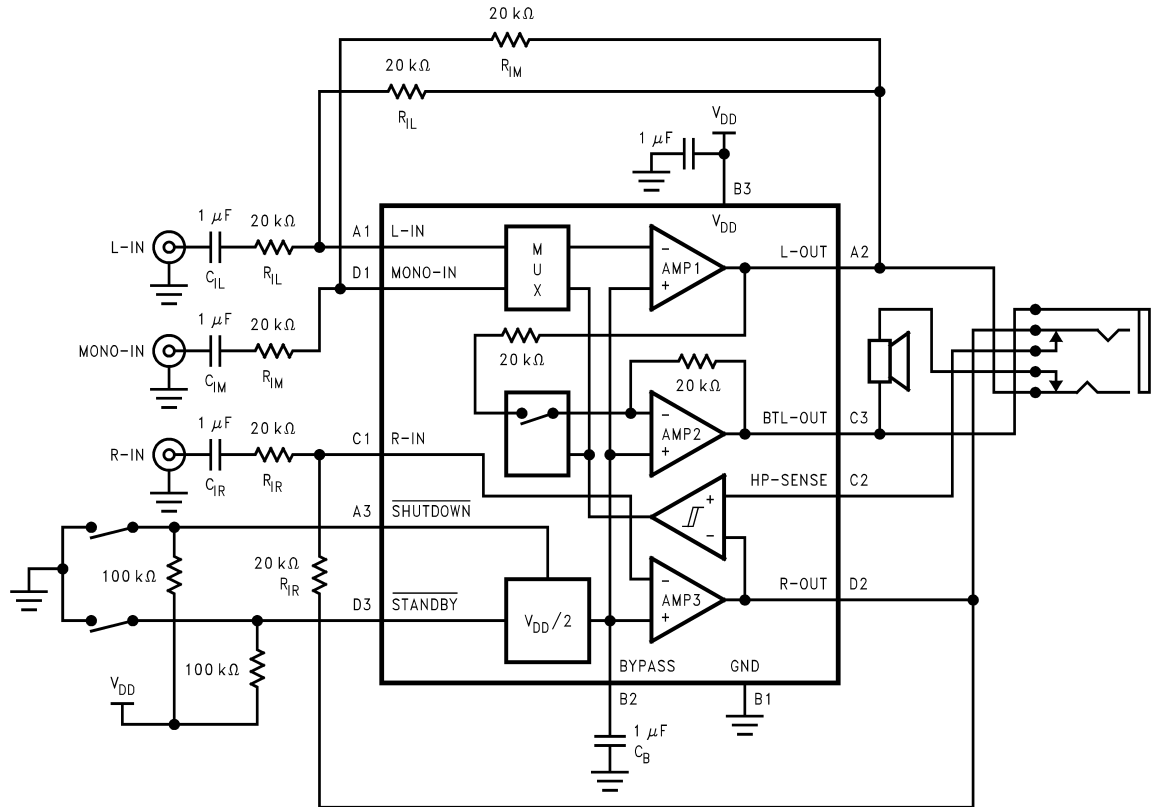

20038201

FIGURE 1. Typical Audio Amplifier Application Circuit

(Pin out shown for the 12-pin large bump micro SMD IBL package. Consult the "Connection Diagrams" for the LLP or MT package pin out.)

Connection Diagrams

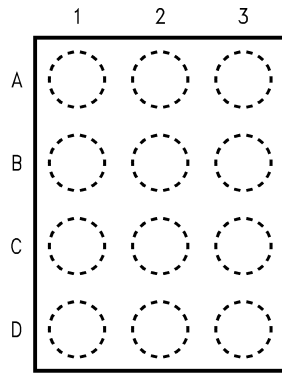

20038202

Top View (Bump-side down)
Order Number LM4854IBL
See NS Package Number BLA12BAB

Micro SMD Marking

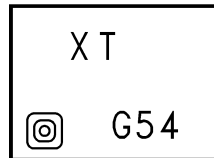

20038203

Top View
X - Date Code
T - Die Traceability
G - Boomer Family
54 - LM4854IBL

LM4854IBL Pin Designation

Pin (Bump) Number	Pin Function
A1	L-IN
B1	GND
C1	R-IN
D1	MONO-IN
A2	L-OUT
B2	BYPASS
C2	HP-SENSE
D2	R-OUT
A3	$\overline{\text{SHUTDOWN}}$
B3	V_{DD}
C3	BTL-OUT
D3	$\overline{\text{STANDBY}}$

Connection Diagrams

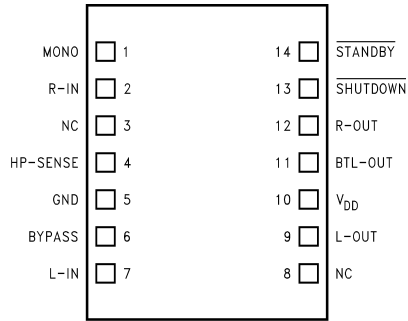

20038204

Top View
Order Number LM4854LD
See NS Package Number LDA14A

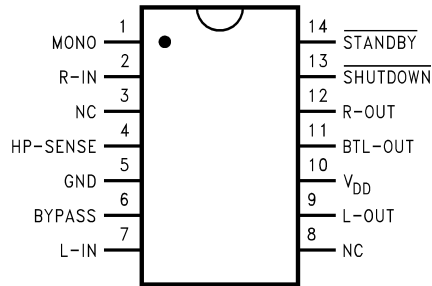

20038205

Top View
Order Number LM4854MT
See NS Package Number MTC14

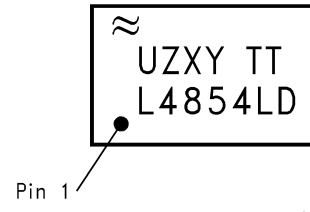

200382A5

Top View
U - Fab Code
Z - Plant Code
XY - Date Code
TT - Die Traceability
Bottom Line - Part Number

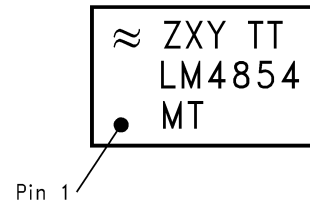

200382A6

Top View
Z - Plant Code
XY - Date Code
TT - Die Traceability
Bottom 2 lines - Part Number

Absolute Maximum Ratings (Notes 2,

3)

If Military/Aerospace specified devices are required, please contact the National Semiconductor Sales Office/Distributors for availability and specifications.

Supply Voltage	6.0V
Storage Temperature	-65°C to +150°C
Input Voltage	-0.3V to $V_{DD} + 0.3V$
Power Dissipation(Note 4)	Internally Limited
ESD Susceptibility (Note 5)	
All pins except Pin C3 (IBL), Pin11 (LD/MT)	2000V
Pin C3 (IBL), Pin 11 (LD/MT)	8000V
ESD Susceptibility(Note 6)	200V
Junction Temperature (T_J)	150°C
Solder Information	
Small Outline Package	
Vapor Phase (60 sec.)	215°C

Infrared (15 sec.)	220°C
See AN-540 "Surface Mounting and their Effects on Product Reliability" for other methods of soldering surface-mount devices.	
Thermal Resistance	
θ_{JA} (typ)—BLA12BAB	121°C/W
θ_{JC} (typ)—LDA14A	3°C/W
θ_{JA} (typ)—LDA14A	42°C/W (Note 7)
θ_{JC} (typ)—MTC14	40°C/W
θ_{JA} (typ)—MTC14	109°C/W

Operating Ratings (Note 3)

Temperature Range	
$T_{MIN} \leq T_A \leq T_{MAX}$	-40°C \leq T_A \leq +85°C
Supply Voltage	2.4V \leq V_{DD} \leq 5.5V

Electrical Characteristics for Entire Amplifier ($V_{DD} = 5V$)

The following specifications apply for circuit shown in Figure 1, unless otherwise specified. Limits apply for $T_A = 25^\circ\text{C}$.

Symbol	Parameter	Conditions	LM4854		Units (Limits)
			Typical (Note 8)	Limit (Notes 9, 10)	
I_{DD}	Quiescent Power Supply Current	$V_{IN} = 0V$; $I_O = 0A$, No Load	5.0	12	mA max)
		$V_{IN} = 0V$; $I_O = 0A$, 8 Ω Load	6.5	15	mA (max)
I_{STBY}	Standby Quiescent Power Supply Current	$V_{STANDBY} = GND$	27	35	μA (max)
I_{SD}	Shutdown Quiescent Power Supply Current	$V_{SHUTDOWN} = GND$	0.05	0.2	μA (max)
V_{OS}	Output Offset Voltage	8 Ω Load	2.0	40	mV (max)
PSRR	Power Supply Rejection Ratio	$C_{BYPASS} = 1.0\mu F$, $R_{SOURCE} = 10\Omega$ $V_{RIPPLE} = 200mV_{p-p}$ sinewave BTL, $R_L = 8\Omega$, $R_{IN} = 10\Omega$ $f_{IN} = 217Hz$ $f_{IN} = 1kHz$ SE, $R_L = 32\Omega$, $R_{IN} = 10\Omega$ $f_{IN} = 217Hz$ $f_{IN} = 1kHz$	61		dB
			63		dB
			68		dB
			71		dB
t_{RSH}	Return-from-Shutdown Time	$C_{BYPASS} = 1.0\mu F$	200		ms
t_{RST}	Return-from-Standby Time		0.1	1.0	ms(max)
V_{IH}	Shutdown or Standby Logic High Threshold			1.4	V (min)
V_{IL}	Shutdown or Standby Logic Low Threshold			0.4	V (max)

Electrical Characteristics Bridged-Mode Operation ($V_{DD} = 5V$)

The following specifications apply for the circuit shown in Figure 1 and a measurement bandwidth of 20Hz to 80kHz, unless otherwise specified. Limits apply for $T_A = 25^\circ C$.

Symbol	Parameter	Conditions	LM4854		Units (Limits)
			Typical (Note 8)	Limit (Notes 9, 10)	
P_O	Output Power (Note 11)	THD = 1% (max); f = 1kHz (Note12) $R_L = 3.2\Omega$ (LM4854LD) $R_L = 4\Omega$ (LM4854LD) $R_L = 8\Omega$	1.9 1.7 1.1	1.0	W W W (min)
		THD = 10% (max); f = 1kHz (Note12) $R_L = 3.2\Omega$ (LM4854LD) $R_L = 4\Omega$ (LM4854LD) $R_L = 8\Omega$	2.3 2.1 1.3		W W W
THD+N	Total Harmonic Distortion+Noise	$20Hz \leq f_{IN} \leq 20kHz$ $R_L = 4\Omega, P_O = 1.0W$ (LM4854LD) $R_L = 8\Omega, P_O = 400mW$	0.3 0.18		% %
		$f_{IN} = 1kHz$ $R_L = 4\Omega, P_O = 1.5W$ (LM4854LD) $R_L = 8\Omega, P_O = 50mW$	0.1 0.08		% %
S/N	Signal-to-Noise Ratio	$f_{IN} = 1kHz, C_{BYPASS} = 1.0\mu F$ $P_O = 900mW, R_L = 8\Omega$	90		dB

Electrical Characteristics : SE Operation ($V_{DD} = 5V$)

The following specifications apply for the circuit shown in Figure 1 and a measurement bandwidth of 20Hz to 80kHz, unless otherwise specified. Limits apply for $T_A = 25^\circ C$.

Symbol	Parameter	Conditions	LM4854		Units (Limits)
			Typical (Note 8)	Limit (Notes 9, 10)	
P_O	Output Power (Note 11)	THD+N = 1.0%, f = 1kHz, $R_L = 32\Omega$	93	85	mW(min)
		THD+N = 10%, f = 1kHz, $R_L = 32\Omega$	105		mW
		THD+N = 1.0%, f = 1kHz, $R_L = 16\Omega$	170	140	mW(min)
		THD+N = 10%, f = 1kHz, $R_L = 16\Omega$	200		mW
THD+N	Total Harmonic Distortion+Noise	$20Hz \leq f_{IN} \leq 20kHz$ $R_L = 32\Omega, P_O = 50mW$	0.3		%
VOU	Output Voltage Swing	THD = 1.0%, $R_L = 5k\Omega$	4.0		V_{P-P}
XTALK	Channel Separation	$f_{IN} = 1kHz, C_{BYPASS} = 1.0\mu F, R_L = 32\Omega$	55		dB
S/N	Signal-to-Noise Ratio	$f_{IN} = 1kHz, C_{BYPASS} = 1.0\mu F$ $P_O = 50mW, R_L = 32\Omega$	90		dB

Electrical Characteristics for Entire Amplifier ($V_{DD} = 3.0V$)

The following specifications apply for circuit shown in Figure 1, unless otherwise specified. Limits apply for $T_A = 25^\circ C$.

Symbol	Parameter	Conditions	LM4854		Units (Limits)
			Typical (Note 8)	Limit (Notes 9, 10)	
I_{DD}	Quiescent Power Supply Current	$V_{IN} = 0V, I_O = 0A, 8\Omega$ Load	4.0	10	mA (max)
I_{STBY}	Standby Quiescent Power Supply Current	$V_{STANDBY} = GND$	16.0	20.0	μA (max)
I_{SD}	Shutdown Current	$V_{SHUTDOWN} = GND$	0.005	0.02	μA (max)
V_{OS}	Output Offset Voltage	8Ω Load	2.0	40	mV (max)

Electrical Characteristics for Entire Amplifier ($V_{DD} = 3.0V$) (Continued)

The following specifications apply for circuit shown in Figure 1, unless otherwise specified. Limits apply for $T_A = 25^\circ C$.

Symbol	Parameter	Conditions	LM4854		Units (Limits)
			Typical (Note 8)	Limit (Notes 9, 10)	
PSRR	Power Supply Rejection Ratio	$C_{BYPASS} = 1.0\mu F$, $R_{SOURCE} = 10\Omega$ $V_{RIPPLE} = 200mV_{p-p}$ sinewave BTL, $R_L = 8\Omega$, $R_{IN} = 10\Omega$ $f_{IN} = 217Hz$ $f_{IN} = 1kHz$	62		dB
			62		dB
		SE, $R_L = 32\Omega$, $R_{IN} = 10\Omega$ $f_{IN} = 217Hz$ $f_{IN} = 1kHz$	68		dB
			72		dB
t_{RSH}	Return-from-Shutdown Time	$C_{BYPASS} = 1.0\mu F$	200		ms
t_{RST}	Return-from-Standby Time		0.1	1.0	ms(max)
V_{IH}	Shutdown or Standby Logic High Threshold			1.4	V (min)
V_{IL}	Shutdown or Standby Logic Low Threshold			0.4	V (max)

Electrical Characteristics : Bridged-Mode Operation ($V_{DD} = 3.0V$) (Notes 4, 9)

The following specifications apply for for the circuit shown in Figure 1 and a measurement bandwidth of 20Hz to 80kHz, unless otherwise specified. Limits apply for $T_A = 25^\circ C$.

Symbol	Parameter	Conditions	LM4854		Units (Limits)
			Typical (Note 8)	Limit (Notes 9, 10)	
P_O	Output Power (Note11)	THD = 1% (max); $f = 1kHz$ (Note11) $R_L = 4\Omega$ (LM4854LD) $R_L = 8\Omega$	1.0 380		W mW (min)
		THD = 10% (max); $f = 1kHz$ (Note11) $R_L = 4\Omega$ (LM4854LD) $R_L = 8\Omega$	1.1 530		W mW
THD+N	Total Harmonic Distortion+Noise	20Hz $\leq f_{IN} \leq 20kHz$ $R_L = 4\Omega$, $P_O = 800mW$ (LM4854LD) $R_L = 8\Omega$, $P_O = 150mW$	0.3 0.21		% %
		$f_{IN} = 1kHz$ $R_L = 4\Omega$, $P_O = 500mW$ (LM4854LD) $R_L = 8\Omega$, $P_O = 150mW$	0.1 0.075		% %
S/N	Signal-to-Noise Ratio	$f_{IN} = 1kHz$, $C_{BYPASS} = 1.0\mu F$ $P_O = 900mW$, $R_L = 8\Omega$	90		dB

Electrical Characteristics : SE Operation ($V_{DD} = 3.0V$) (Notes 4, 9)

The following specifications apply for the circuit shown in Figure 1 and a measurement bandwidth of 20Hz to 80kHz, unless otherwise specified. Limits apply for $T_A = 25^\circ C$.

Symbol	Parameter	Conditions	LM4854		Units (Limits)
			Typical (Note 8)	Limit (Notes 9, 10)	
P_O	Output Power (Note 11)	THD+N = 1.0%, f = 1kHz, $R_L = 32\Omega$	32	27	mW(min)
		THD+N = 10%, f = 1kHz, $R_L = 32\Omega$	60		mW
		THD+N = 1.0%, f = 1kHz, $R_L = 16\Omega$	57	38	mW (min)
		THD+N = 10%, f = 1kHz, $R_L = 16\Omega$	100		mW
THD+N	Total Harmonic Distortion+Noise	20Hz $\leq f_{IN} \leq$ 20kHz $R_L = 32\Omega$, $P_O = 30mW$	0.3		%
VOUT	Output Voltage Swing	THD = 0.5%, $R_L = 5k\Omega$	2.4		V_{P-P}
XTALK	Channel Separation	$f_{IN} = 1kHz$, $C_{BYPASS} = 1.0\mu F$, $R_L = 32\Omega$	55		dB
S/N	Signal-to-Noise Ratio	$f_{IN} = 1kHz$, $C_{BYPASS} = 1.0\mu F$ $P_O = 30mW$, $R_L = 32\Omega$	TBD		dB

Note 2: All voltages are measured with respect to the GND pin unless other wise specified.

Note 3: Absolute Maximum Ratings indicate limits beyond which damage to the device may occur. Operating Ratings indicate conditions for which the device is functional but do not guarantee specific performance limits. Electrical Characteristics state DC and AC electrical specifications under particular test conditions that guarantee specific performance limits. This assumes that the device is within the Operating Ratings. Specifications are not guaranteed for parameters where no limit is given, however, the typical value is a good indication of device performance.

Note 4: The maximum power dissipation must be derated at elevated temperatures and is dictated by T_{JMAX} , θ_{JA} , and the ambient temperature, T_A . The maximum allowable power dissipation is $P_{DMAX} = (T_{JMAX} - T_A)/\theta_{JA}$ or the number given in Absolute Maximum Ratings, whichever is lower. For the LM4854, see power derating currents for more information.

Note 5: Human body model, 100pF discharged through a 1.5k Ω resistor.

Note 6: Machine Model, 220pF-240pF discharged through all pins.

Note 7: The given θ_{JA} is for an LM4854 packaged in an LDA14A with the Exposed-DAP soldered to an exposed 2in2 area of 1oz printed circuit board copper.

Note 8: Typicals are measured at 25°C and represent the parametric norm.

Note 9: Limits are guaranteed to National's AOQL (Average Outgoing Quality Level).

Note 10: Datasheet minimum and maximum specification limits are guaranteed by design, test, or statistical analysis.

Note 11: Output power is measured at the amplifier's package pins.

Note 12: When driving 4 Ω loads and operating on a 5V supply, the LM4854LD must be mounted to a circuit board that has a minimum of 2.5in2 of exposed, uninterrupted copper area connected to the LLP package's exposed DAP.

External Components Description

See Figure 1.

Components	Functional Description
1. R_i	This is the inverting input resistance that, along with R_f , sets the closed-loop gain. Input resistance R_i and input capacitance C_i form a high pass filter. The filter's cutoff frequency is $f_c = 1/2\pi R_i C_i$.
2. C_i	This is the input coupling capacitor. It blocks DC voltage at the amplifier's inverting input. C_i and R_i create a highpass filter. The filter's cutoff frequency is $f_c = 1/2\pi R_i C_i$. Refer to the Application Information section, SELECTING EXTERNAL COMPONENTS , for an explanation of determining C_i 's value.
3. R_f	This is the feedback resistance that, along with R_i , sets the closed-loop gain.
4. C_s	The supply bypass capacitor. Refer to the POWER SUPPLY BYPASSING section for information about properly placing, and selecting the value of, this capacitor.
5. C_B	This capacitor filters the half-supply voltage present on the BYPASS pin. Refer to the Application Information section, SELECTING EXTERNAL COMPONENTS , for information about properly placing, and selecting the value of, this capacitor..

Typical Performance Characteristics

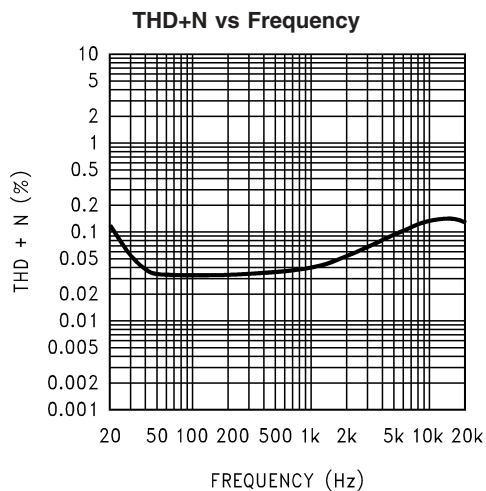

LM4854LD
 $V_{DD} = 5V$, $R_L = 4\Omega$ (BTL),
 $P_{OUT} = 1000mW$

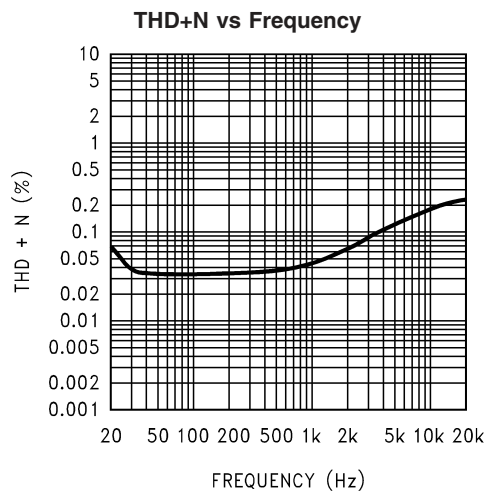

LM4854LD
 $V_{DD} = 5V$, $R_L = 4\Omega$ (BTL),
 $P_{OUT} = 400mW$

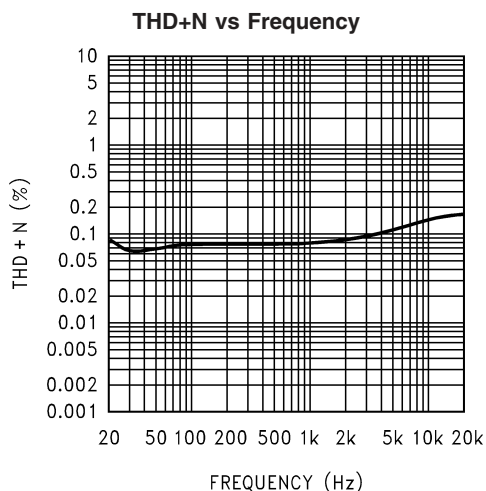

LM4854LD
 $V_{DD} = 5V$, $R_L = 8\Omega$ (BTL),
 $P_{OUT} = 400mW$

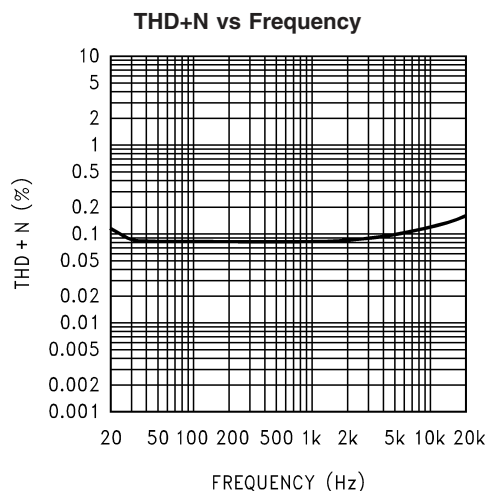

LM4854LD
 $V_{DD} = 5V$, $R_L = 16\Omega$ (SE),
 $P_{OUT} = 50mW$

Typical Performance Characteristics (Continued)

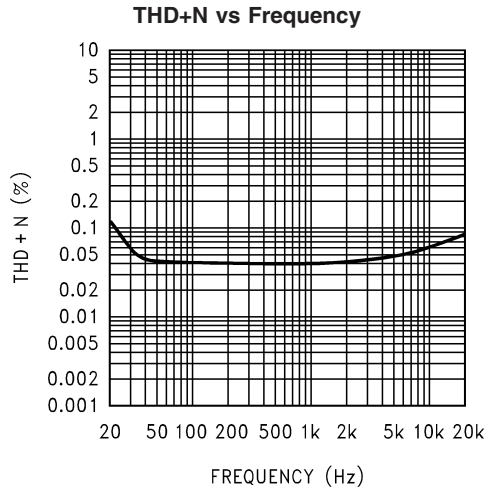

$V_{DD} = 5V, R_L = 32\Omega$ (SE),
 $P_{OUT} = 50mW$

200382B9

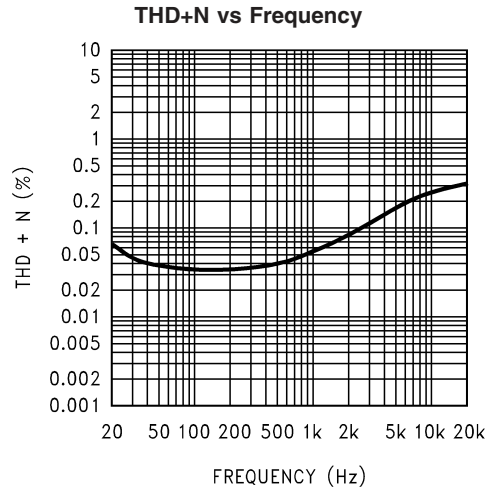

LM4854LD
 $V_{DD} = 3V, R_L = 4\Omega$ (BTL),
 $P_{OUT} = 150mW$

200382E0

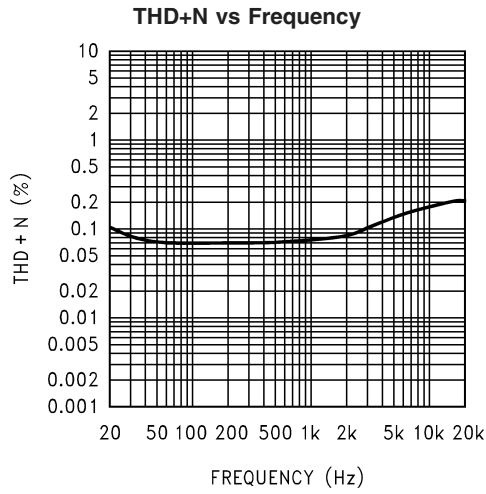

$V_{DD} = 3V, R_L = 8\Omega$ (BTL),
 $P_{OUT} = 150mW$

200382B7

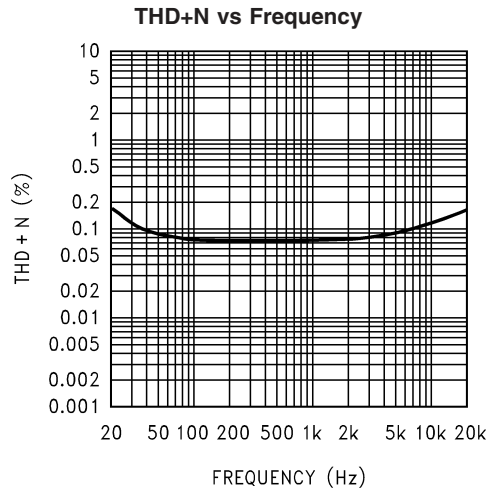

$V_{DD} = 3V, R_L = 16\Omega$ (SE),
 $P_{OUT} = 30mW$

200382B5

Typical Performance Characteristics (Continued)

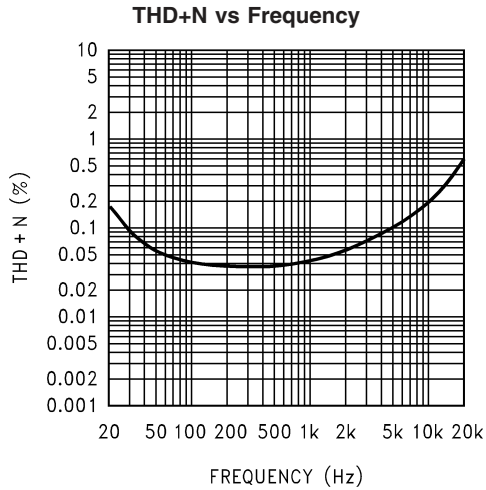

$V_{DD} = 3V, R_L = 32\Omega$ (SE),
 $P_{OUT} = 30mW$

200382B6

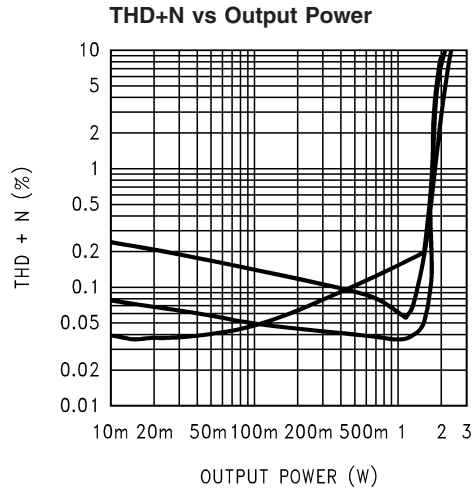

LM4854LD
 $V_{DD} = 5V, R_L = 4\Omega$ (BTL),
at (from top to bottom at 200mW)
20kHz, 20Hz, 1kHz

200382E1

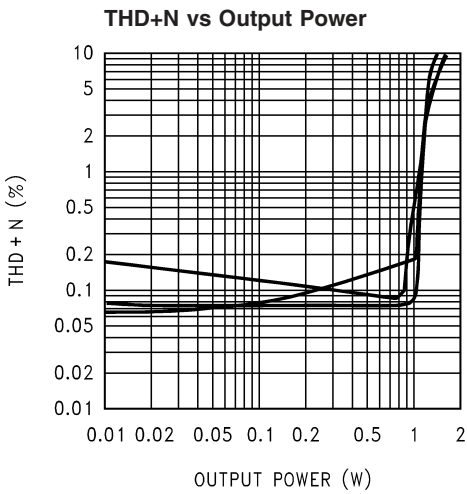

$V_{DD} = 5V, R_L = 8\Omega$ (BTL),
at (from top to bottom at 0.2W)
20kHz, 20Hz, 1kHz

200382C6

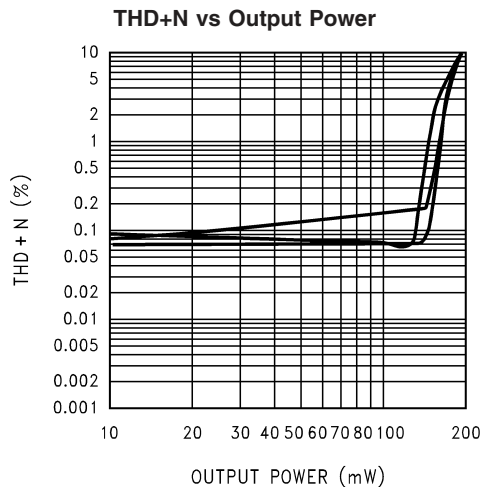

$V_{DD} = 5V, R_L = 16\Omega$ (SE),
at (from top to bottom at 30mW)
20kHz, 20Hz, 1kHz

200382C4

Typical Performance Characteristics (Continued)

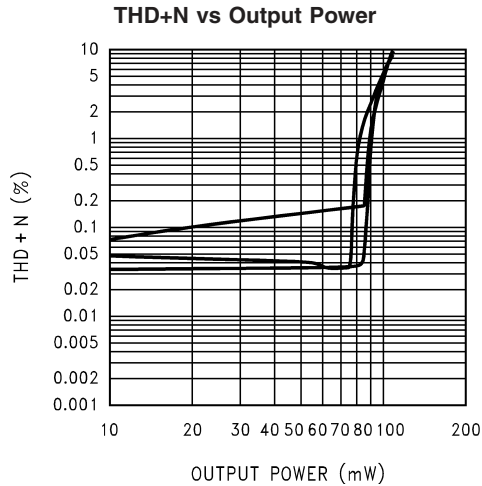

$V_{DD} = 5V, R_L = 32\Omega$ (SE),
at (from top to bottom at 20mW)
20kHz, 20Hz, 1kHz

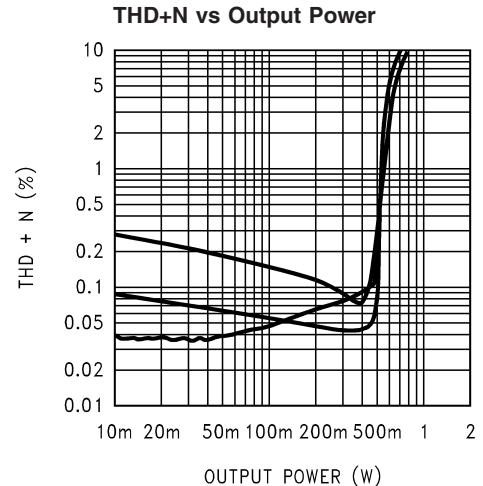

LM4854LD
 $V_{DD} = 3V, R_L = 4\Omega$ (BTL),
at (from top to bottom at 200mW)
20kHz, 20Hz, 1kHz

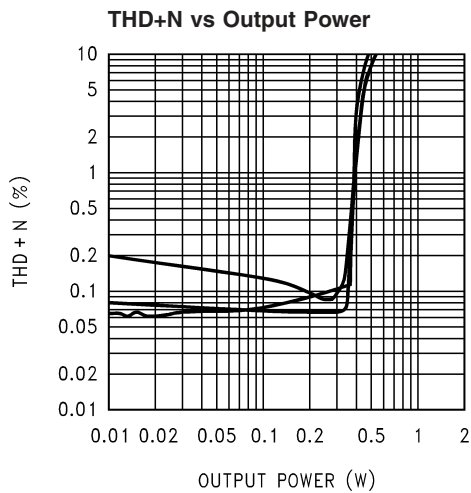

$V_{DD} = 3V, R_L = 8\Omega$ (BTL),
at (from top to bottom at 0.02W)
20kHz, 20Hz, 1kHz

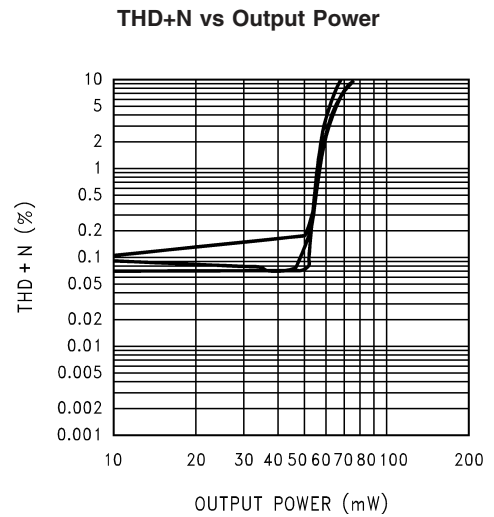

$V_{DD} = 3V, R_L = 16\Omega$ (SE),
at (from top to bottom at 20mW)
20kHz, 20Hz, 1kHz

Typical Performance Characteristics (Continued)

THD+N vs Output Power

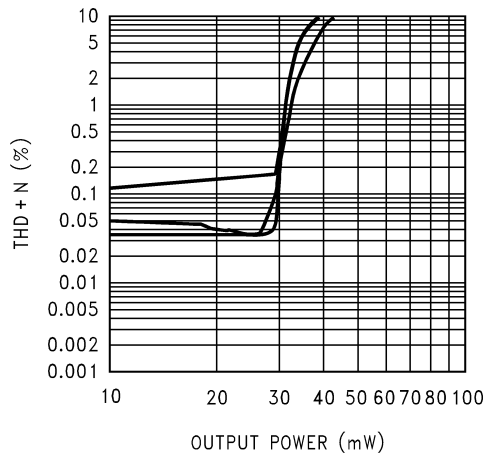

$V_{DD} = 3V$, $R_L = 32\Omega$ (SE),
at (from top to bottom at 20mW)
20kHz, 20Hz, 1kHz

200382C2

Output Power vs Power Supply Voltage

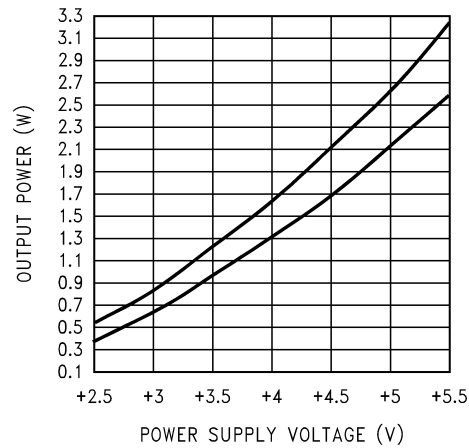

$R_L = 8\Omega$ (BTL), $f_{IN} = 1kHz$,
at (from top to bottom at 4V)
10% THD+N, 1% THD+N

200382A8

Output Power vs Power Supply Voltage

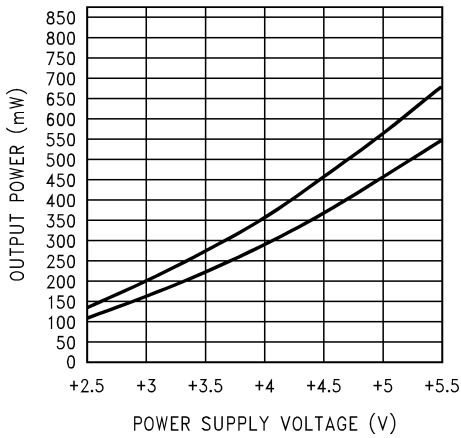

$R_L = 16\Omega$ (BTL), $f_{IN} = 1kHz$,
at (from top to bottom at 4V):
10% THD+N, 1% THD+N

200382A7

PSRR vs Frequency

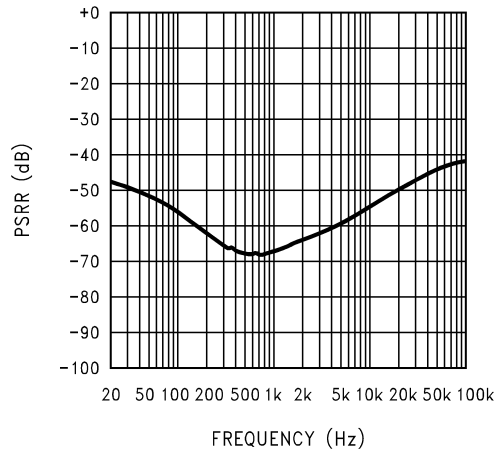

LM4854LD
 $V_{DD} = 5V$, $R_L = 4\Omega$ (BTL),
 $R_{SOURCE} = 10\Omega$

200382E3

Typical Performance Characteristics (Continued)

PSRR vs Frequency

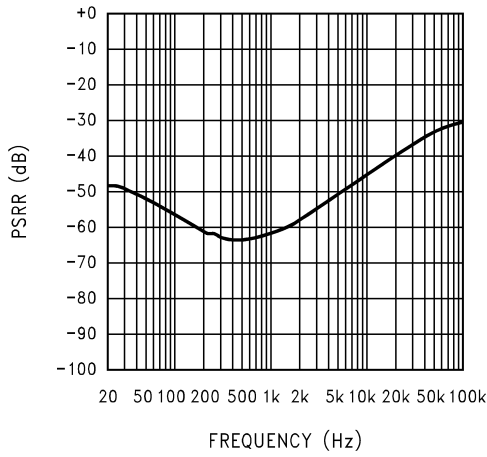

$V_{DD} = 5V, R_L = 8\Omega$ (BTL),
 $R_{SOURCE} = 10\Omega$

PSRR vs Frequency

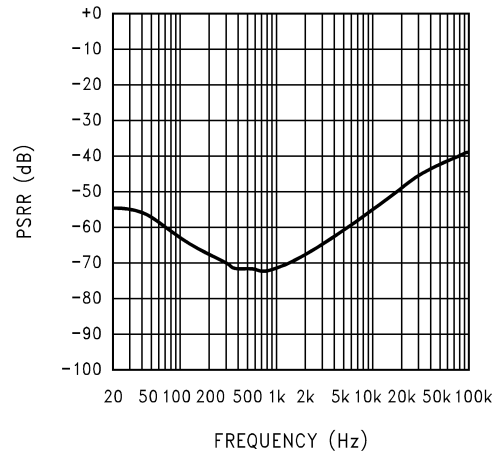

$V_{DD} = 5V, R_L = 16\Omega$ (SE),
 $R_{SOURCE} = 10\Omega$

PSRR vs Frequency

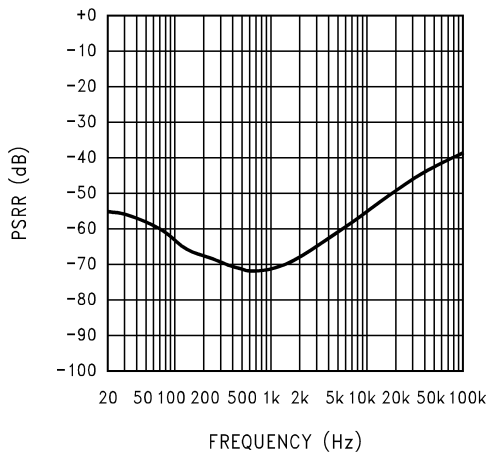

$V_{DD} = 5V, R_L = 32\Omega$ (SE),
 $R_{SOURCE} = 10\Omega$

PSRR vs Frequency

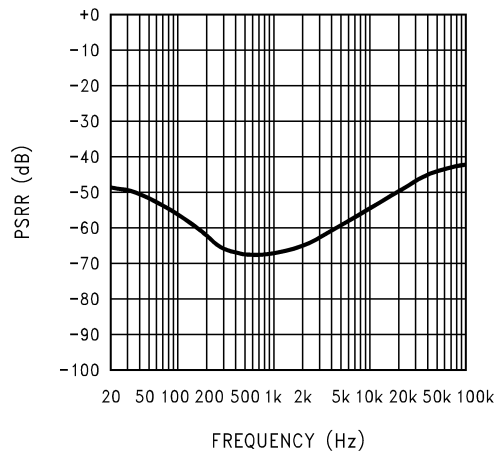

LM4854LD
 $V_{DD} = 3V, R_L = 4\Omega$ (BTL),
 $R_{SOURCE} = 10\Omega$

Typical Performance Characteristics (Continued)

PSRR vs Frequency

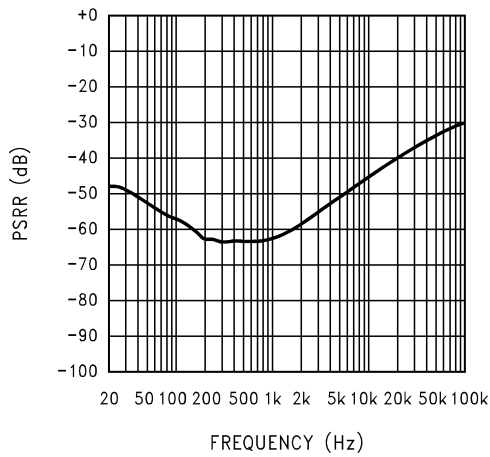

$V_{DD} = 3V, R_L = 8\Omega$ (BTL),
 $R_{SOURCE} = 10\Omega$

PSRR vs Frequency

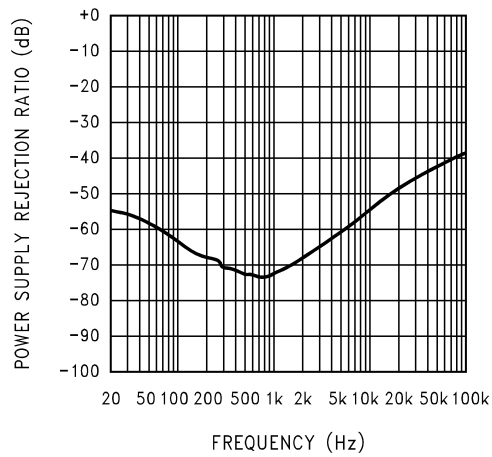

$V_{DD} = 3V, R_L = 16\Omega$ (SE),
 $R_{SOURCE} = 10\Omega$

PSRR vs Frequency

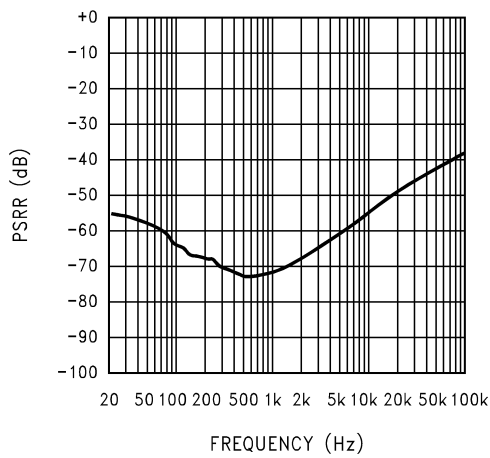

$V_{DD} = 3V, R_L = 32\Omega$ (SE),
 $R_{SOURCE} = 10\Omega$

Amplifier Power Dissipation vs Load Power Dissipation

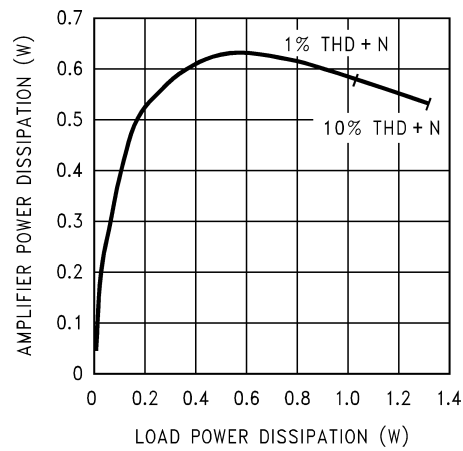

LM4854IBL/MT, $V_{DD} = 5V,$
 $R_L = 8\Omega$ (BTL), $f_{IN} = 1kHz$

Typical Performance Characteristics (Continued)

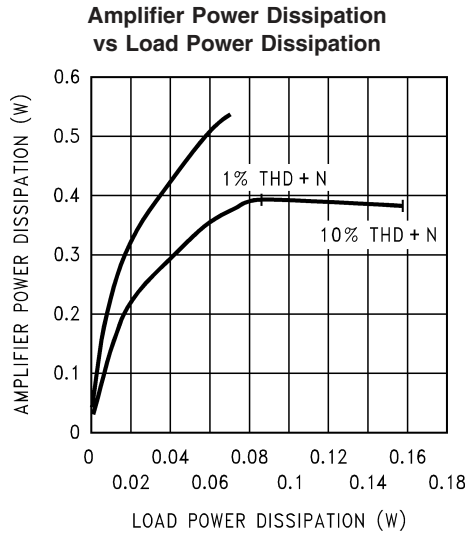

**LM4854IBL/MT, $V_{DD} = 5V$,
(from top to bottom at 0.04W):
 $R_L = 16\Omega$ (SE), $R_L = 32\Omega$ (SE), $f_{IN} = 1kHz$,
both channels driven and loaded**

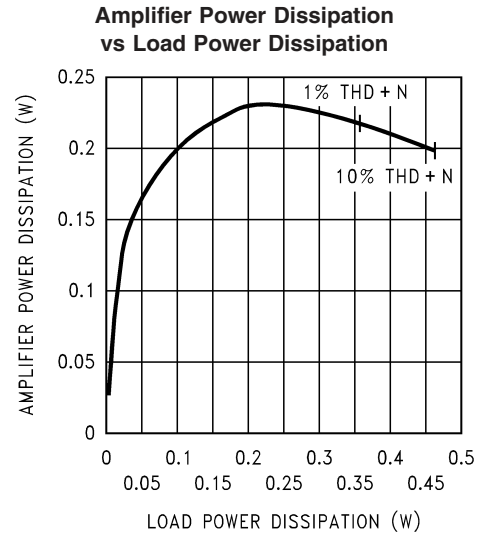

**LM4854IBL/MT, $V_{DD} = 3V$,
 $R_L = 8\Omega$ (BTL), $f_{IN} = 1kHz$**

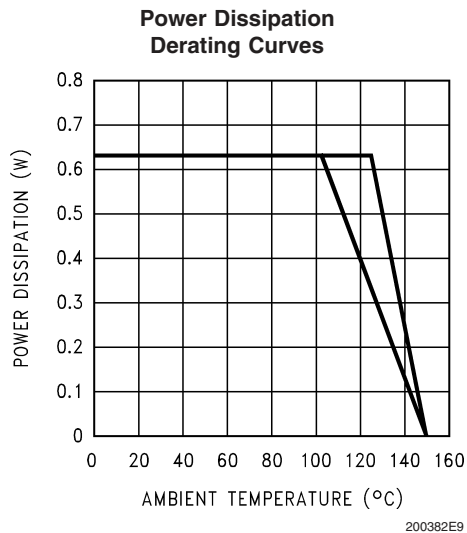

**LM4854LD, $V_{DD} = 5V$,
 $R_L = 8\Omega$ (BTL), $f_{IN} = 1kHz$,
(from top to bottom at 120°C):
4in² copper plane heatsink area
1in² copper plane heatsink area**

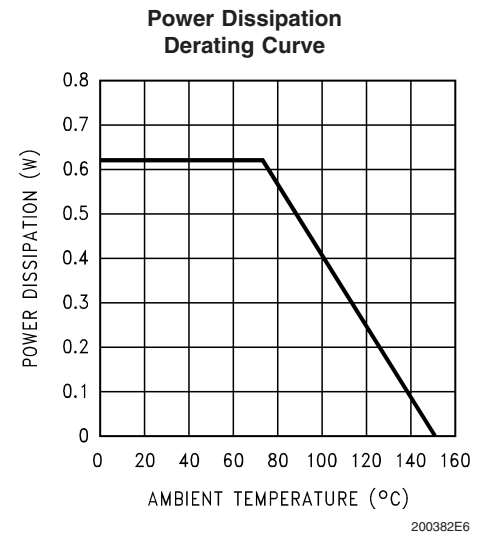

**LM4854IBL, $V_{DD} = 5V$,
 $R_L = 8\Omega$ (BTL), $f_{IN} = 1kHz$**

Typical Performance Characteristics (Continued)

Power Dissipation Derating Curve

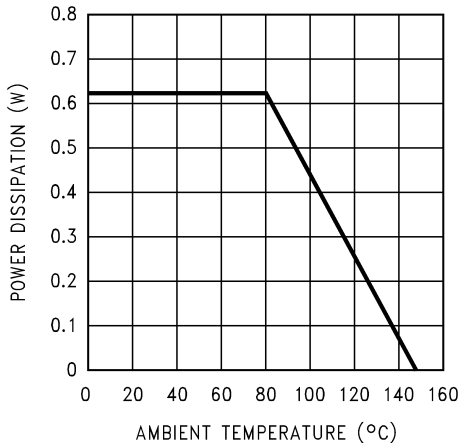

LM4854MT, $V_{DD} = 5V$,
 $R_L = 8\Omega$ (BTL), $f_{IN} = 1kHz$

200382E7

Amplifier Power Dissipation vs Load Power Dissipation

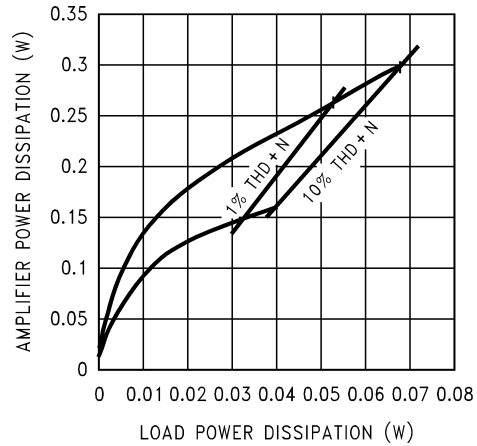

LM4854IBL/MT, $V_{DD} = 3V$,
 (from top to bottom at 0.02W):
 $R_L = 16\Omega$ (SE), $R_L = 32\Omega$ (SE), $f_{IN} = 1kHz$,
 both channels driven and loaded

200382C9

Output Power vs Load Resistance

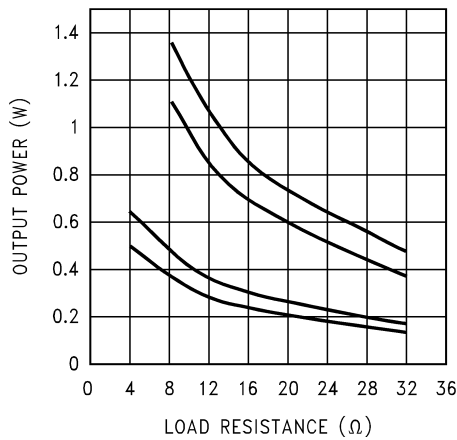

LM4854IBL/MT, BTL Load,
 (from top to bottom at 12Ω):
 $V_{DD} = 5V, THD+N = 10\%$;
 $V_{DD} = 5V, THD+N = 1\%$
 $V_{DD} = 3V, THD+N = 10\%$
 $V_{DD} = 3V, THD+N = 1\%$

200382D2

Output Power vs Load Resistance

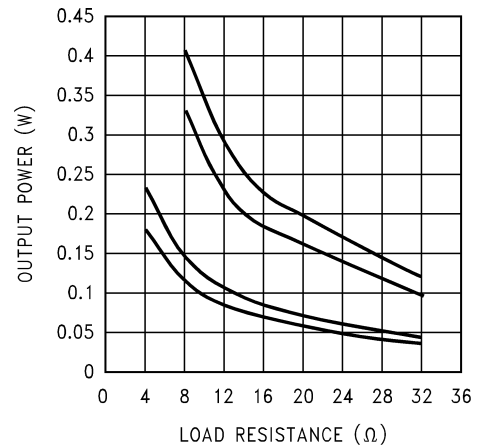

LM4854IBL/MT, SE Load (both channels driven and loaded),
 $f_{IN} = 1kHz$, (from top to bottom at 12Ω):
 $V_{DD} = 5V, THD+N = 10\%$;
 $V_{DD} = 5V, THD+N = 1\%$
 $V_{DD} = 3V, THD+N = 10\%$
 $V_{DD} = 3V, THD+N = 1\%$

200382D3

Typical Performance Characteristics (Continued)

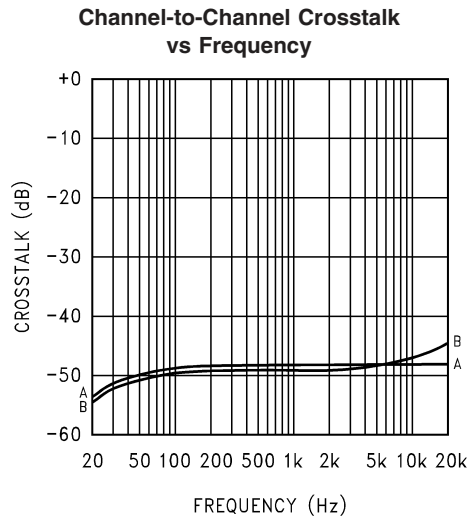

$V_{DD} = 5V, R_L = 16\Omega$ (SE)

A = Left channel driven, right channel measured
B = Right channel driven, left channel measured

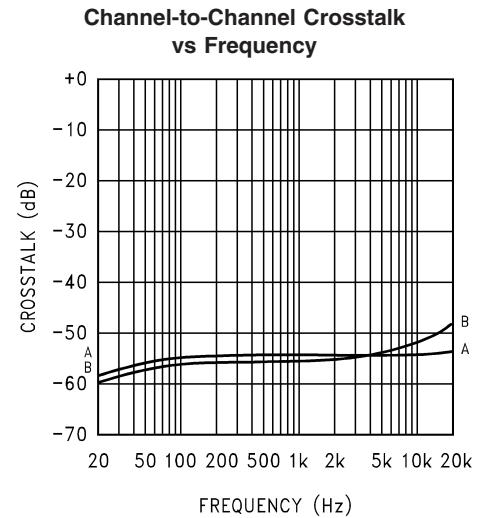

$V_{DD} = 5V, R_L = 32\Omega$ (SE)

A = Left channel driven, right channel measured
B = Right channel driven, left channel measured

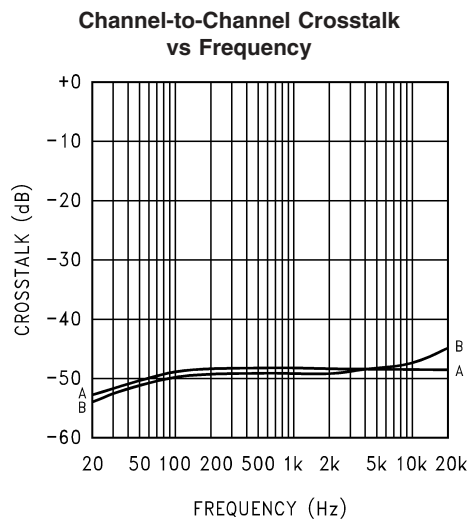

$V_{DD} = 3V, R_L = 16\Omega$ (SE)

A = Left channel driven, right channel measured
B = Right channel driven, left channel measured

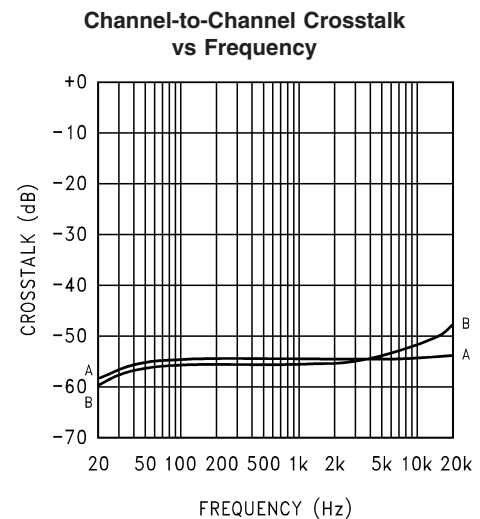

$V_{DD} = 3V, R_L = 32\Omega$ (SE)

A = Left channel driven, right channel measured
B = Right channel driven, left channel measured

Application Information

ELIMINATING OUTPUT COUPLING CAPACITORS

Typical single-supply audio amplifiers that can switch between driving bridge-tied-load (BTL) speakers and single-ended (SE) headphones use a coupling capacitor on each SE output. This capacitor blocks the half-supply voltage to which the output amplifiers are typically biased and couples the audio signal to the headphones. The signal returns to circuit ground through the headphone jack's sleeve.

The LM4854 eliminates these coupling capacitors. When the LM4854 is configured to drive SE loads, AMP2 is internally configured to apply $V_{DD}/2$ to a stereo headphone jack's sleeve. This voltage equals the quiescent voltage present on the Amp1 and Amp3 outputs that drive the headphones.

Headphones driven by the LM4854 operate in a manner very similar to a BTL load. The same DC voltage is applied to each input terminal on a headphone speaker. This results in no net DC current flow through the speaker. AC current flows through a headphone speaker as an audio signal's output amplitude increases on one of the speaker's terminal.

When operating as a headphone amplifier, the headphone jack sleeve is not connected to circuit ground, but to $V_{DD}/2$. Using the headphone output jack as a line-level output will place the LM4854's one-half supply voltage on a plug's sleeve connection. Driving a portable notebook computer or audio-visual display equipment is possible. This presents no difficulty when the external equipment uses capacitively coupled inputs. For the very small minority of equipment that is DC-coupled, the LM4854 monitors the current supplied by

Application Information (Continued)

the amplifier that drives the headphone jack's sleeve. If this current exceeds 500mA_{PK} , the amplifier is shutdown, pro-

tecting the LM4854 and the external equipment. For more information, see the section titled 'Single-Ended Output Power Performance and Measurement Considerations'.

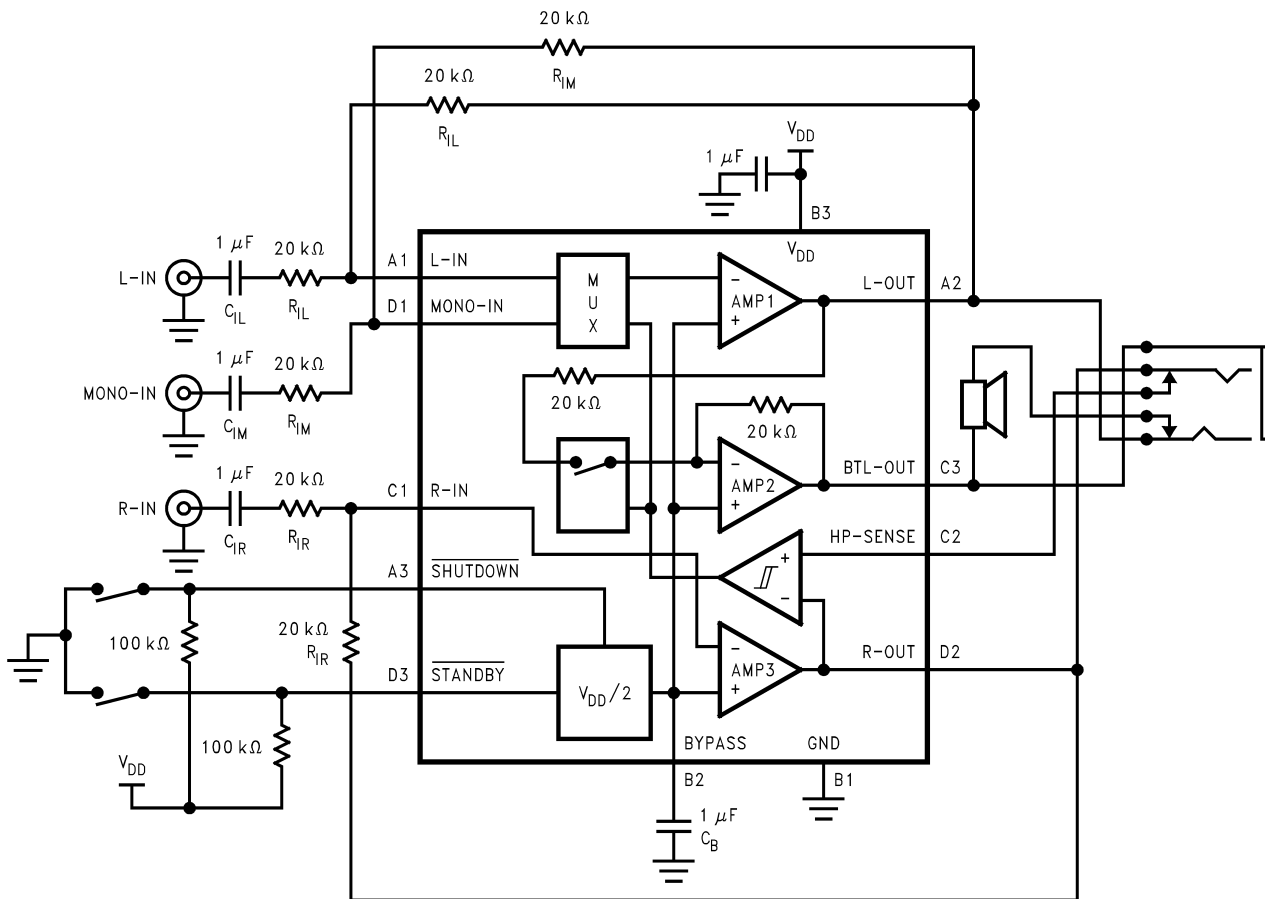

20038207

FIGURE 2. Typical Audio Amplifier Application Circuit

EXPOSED-DAP MOUNTING CONSIDERATIONS

The LM4854's exposed-DAP (die attach paddle) package (LD) provides a low thermal resistance between the die and the PCB to which the part is mounted and soldered. This allows rapid heat transfer from the die to the surrounding PCB copper area heatsink, copper traces, ground plane, and finally, surrounding air. The result is a low voltage audio power amplifier that produces 1.7W dissipation in a 4Ω load at $\leq 1\%$ THD+N and over 1.9W in a 3Ω load at 10% THD+N. This high power is achieved through careful consideration of necessary thermal design. Failing to optimize thermal design may compromise the LM4854's high power performance and activate unwanted, though necessary, thermal shutdown protection.

The LD package must have its DAP soldered to a copper pad on the PCB. The DAP's PCB copper pad is then, ideally, connected to a large plane of continuous unbroken copper. This plane forms a thermal mass, heat sink, and radiation area. Place the heat sink area on either outside plane in the case of a two-sided or multi-layer PCB. (The heat sink area can also be placed on an inner layer of a multi-layer board. The thermal resistance, however, will be higher.) Connect the DAP copper pad to the inner layer or backside copper

heat sink area with 6 (3 X 2) (LD) vias. The via diameter should be 0.012in - 0.013in with a 1.27mm pitch. Ensure efficient thermal conductivity by plugging and tenting the vias with plating and solder mask, respectively.

Best thermal performance is achieved with the largest practical copper heat sink area. If the heatsink and amplifier share the same PCB layer, a nominal 2.5in^2 (min) area is necessary for 5V operation with a 4Ω load. Heatsink areas not placed on the same PCB layer as the LM4854 should be 5in^2 (min) for the same supply voltage and load resistance. The last two area recommendations apply for 25°C ambient temperature. Increase the area to compensate for ambient temperatures above 25°C . In all circumstances and under all conditions, the junction temperature must be held below 150°C to prevent activating the LM4854's thermal shutdown protection. The LM4854's power de-rating curve in the **Typical Performance Characteristics** shows the maximum power dissipation versus temperature. Example PCB layouts for the exposed-DAP TSSOP and LD packages are shown in the **Demonstration Board Layout** section. Further detailed and specific information concerning PCB layout and fabrication and mounting an LD (LLP) is found in National Semiconductor's AN1187.

Application Information (Continued)

PCB LAYOUT AND SUPPLY REGULATION CONSIDERATIONS FOR DRIVING 3Ω AND 4Ω LOADS

Power dissipated by a load is a function of the voltage swing across the load and the load's impedance. As load impedance decreases, load dissipation becomes increasingly dependent on the interconnect (PCB trace and wire) resistance between the amplifier output pins and the load's connections. Residual trace resistance causes a voltage drop, which results in power dissipated in the trace and not in the load as desired. For example, 0.1Ω trace resistance reduces the output power dissipated by a 4Ω load from 1.7W to 1.6W. The problem of decreased load dissipation is exacerbated as load impedance decreases. Therefore, to maintain the highest load dissipation and widest output voltage swing, PCB traces that connect the output pins to a load must be as wide as possible.

Poor power supply regulation adversely affects maximum output power. A poorly regulated supply's output voltage decreases with increasing load current. Reduced supply voltage causes decreased headroom, output signal clipping, and reduced output power. Even with tightly regulated supplies, trace resistance creates the same effects as poor supply regulation. Therefore, making the power supply traces as wide as possible helps maintain full output voltage swing.

BRIDGE CONFIGURATION EXPLANATION

As shown in Figure 2, the LM4854 consists of three operational amplifiers. In mono mode, AMP1 and AMP2 operate in series to drive a speaker connected between their outputs. In stereo mode, AMP1 and AMP3 are used to drive stereo headphones or other SE load.

In mono mode, external resistors R_{FL} and R_{IL} set the closed-loop gain of AMP1, whereas two internal 20kΩ resistors set AMP2's gain at -1. The LM4854 drives a load, such as a speaker, connected between the two amplifier outputs, L-OUT and BTL-OUT.

Figure 2 shows that AMP1's output serves as AMP2's input. This results in both amplifiers producing signals identical in magnitude, but 180° out of phase. Taking advantage of this phase difference, a load is placed between L-OUT and BTL-OUT and driven differentially (commonly referred to as "bridge mode"). This results in a differential, or BTL, gain of:

$$A_{VD} = 2(R_f/R_i) \quad (1)$$

Bridge mode amplifiers are different from single-ended amplifiers that drive loads connected between a single amplifier's output and ground. For a given supply voltage, bridge mode has a distinct advantage over the single-ended configuration: its differential output doubles the voltage swing across the load. Theoretically, this produces four times the output power when compared to a single-ended amplifier under the same conditions. This increase in attainable output power assumes that the amplifier is not current limited and that the output signal is not clipped. To ensure minimum output signal clipping when choosing an amplifier's closed-loop gain, refer to the Audio Power Amplifier Design section.

Another advantage of the differential bridge output is no net DC voltage across the load. This is accomplished by biasing AMP1's and AMP2's outputs at half-supply. This eliminates the coupling capacitor that single supply, single-ended amplifiers require. Eliminating an output coupling capacitor in a

typical single-ended configuration forces a single-supply amplifier's half-supply bias voltage across the load. This increases internal IC power dissipation and may permanently damage loads such as speakers.

POWER DISSIPATION

Power dissipation is a major concern when designing a successful single-ended or bridged amplifier. Equation (2) states the maximum power dissipation point for a single-ended amplifier operating at a given supply voltage and driving a specified output load.

$$P_{DMAX-SE} = (V_{DD})^2 / (2\pi^2 R_L): \text{Single-Ended} \quad (2)$$

However, a direct consequence of the increased power delivered to the load by a bridge amplifier is higher internal power dissipation for the same conditions. The LM4854 has two operational amplifiers driving a mono bridge load. The maximum internal power dissipation operating in the bridge mode is twice that of a single-ended amplifier. From Equation (3), assuming a 5V power supply and an 8Ω load, the maximum BTL-mode power dissipation is 317mW.

$$P_{DMAX-MONOBTL} = 4(V_{DD})^2 / (2\pi^2 R_L): \text{Bridge Mode} \quad (3)$$

The maximum power dissipation point given by Equation (3) must not exceed the power dissipation given by Equation (4):

$$P_{DMAX}' = (T_{JMAX} - T_A) / \theta_{JA} \quad (4)$$

The LM4854's $T_{JMAX} = 150^\circ\text{C}$. In the IBL package, the LM4854's θ_{JA} is 121°C/W. The LM4854's $T_{JMAX} = 150^\circ\text{C}$. In the LD package soldered to a DAP pad that expands to a copper area of 2.0in² on a PCB, the LM4854's θ_{JA} is 42°C/W. In the MT package, the LM4854's θ_{JA} is 109°C/W. At any given ambient temperature T_A , use Equation (4) to find the maximum internal power dissipation supported by the IC packaging. Rearranging Equation (4) and substituting P_{DMAX} for P_{DMAX}' results in Equation (5). This equation gives the maximum ambient temperature that still allows maximum stereo power dissipation without violating the LM4854's maximum junction temperature.

$$T_A = T_{JMAX} - P_{DMAX-MONOBTL}\theta_{JA} \quad (5)$$

For a typical application with a 5V power supply and an 8Ω load, the maximum ambient temperature that allows maximum stereo power dissipation without exceeding the maximum junction temperature is approximately 73°C for the IBL package.

$$T_{JMAX} = P_{DMAX-MONOBTL}\theta_{JA} + T_A \quad (6)$$

Equation (6) gives the maximum junction temperature T_{JMAX} . If the result violates the LM4854's 150°C, reduce the maximum junction temperature by reducing the power supply voltage or increasing the load resistance. Further allowance should be made for increased ambient temperatures.

The above examples assume that a device is a surface mount part operating around the maximum power dissipation point. Since internal power dissipation is a function of output

Application Information (Continued)

power, higher ambient temperatures are allowed as output power or duty cycle decreases. If the result of Equation (3) is greater than that of Equation (4), then decrease the supply voltage, increase the load impedance, or reduce the ambient temperature. If these measures are insufficient, a heat sink can be added to reduce θ_{JA} . The heat sink can be created using additional copper area around the package, with connections to the ground pin(s), supply pin and amplifier output pins. External, solder attached SMT heatsinks such as the Thermalloy 7106D can also improve power dissipation. When adding a heat sink, the θ_{JA} is the sum of θ_{JC} , θ_{CS} , and θ_{SA} . (θ_{JC} is the junction-to-case thermal impedance, θ_{CS} is the case-to-sink thermal impedance, and θ_{SA} is the sink-to-ambient thermal impedance.) Refer to the Typical Performance Characteristics curves for power dissipation information at lower output power levels.

POWER SUPPLY BYPASSING

As with any power amplifier, proper supply bypassing is critical for low noise performance and high power supply rejection. Applications that employ a 5V regulator typically use a 10 μ F in parallel with a 0.1 μ F filter capacitors to stabilize the regulator's output, reduce noise on the supply line, and improve the supply's transient response. However, their presence does not eliminate the need for a local 1.0 μ F tantalum bypass capacitance connected between the LM4854's supply pins and ground. Do not substitute a ceramic capacitor for the tantalum. Doing so may cause oscillation. Keep the length of leads and traces that connect capacitors between the LM4854's power supply pin and ground as short as possible. Connecting a 1 μ F capacitor, CB, between the BYPASS pin and ground improves the internal bias voltage's stability and improves the amplifier's PSRR. The PSRR improvements increase as the bypass pin capacitor value increases. Too large, however, increases turn-on time and can compromise the amplifier's click and pop performance. The selection of bypass capacitor values, especially CB, depends on desired PSRR requirements, click and pop performance (as explained in the section, Proper Selection of External Components), system cost, and size constraints.

STANDBY

The LM4854 features a low-power, fast turn-on standby mode. Applying a logic-low to the STANDBY pin act activates the standby mode. When this mode is active, the power supply current decreases to a nominal value of 30 μ A and the amplifier outputs are muted. Fast turn-on is assured because all bias points remain at the same voltage as when the part is in fully active operation. The LM4854 returns to fully active operation in 100 μ s (typ) after the input voltage on the STANDBY pin switches from a logic low to a logic high.

MICRO-POWER SHUTDOWN

The LM4854 features an active-low micro-power shutdown mode. When active, the LM4854's micro-power shutdown feature turns off the amplifier's bias circuitry, reducing the supply current. The logic threshold is typically $V_{DD}/2$. The low 0.1 μ A typical shutdown current is achieved by applying a voltage to the SHUTDOWN pin that is as near to GND as possible. A voltage that is greater than GND may increase the shutdown current.

CONTROLLING STANDBY AND MICROPOWER SHUTDOWN

There are a few methods to control standby or micro-power shutdown. These include using a single-pole, single-throw switch (SPST), a microprocessor, or a microcontroller. When using a switch, connect a 100k Ω pull-up resistor between the STANDBY or SHUTDOWN pin and V_{DD} and the SPST switch between the STANDBY or SHUTDOWN pin and GND. Select normal amplifier operation by opening the switch. Closing the switch applies GND to the STANDBY or SHUTDOWN pins, activating micro-power shutdown. The switch and resistor guarantee that the STANDBY or SHUTDOWN pins will not float. This prevents unwanted state changes. In a system with a microprocessor or a microcontroller, use a digital output to apply the active-state voltage to the STANDBY or SHUTDOWN pin.

HEADPHONE (SINGLE-ENDED) AMPLIFIER OPERATION

Previous single-supply amplifiers that were designed to drive both BTL and SE loads used a SE (or headphone) "sense" input. This input typically required two external resistors to bias the sense input to a preset voltage that selected BTL operation.

The LM4854 has a unique headphone sense circuit that eliminates the external resistors. The amplifier has an internal comparator that monitors the voltage present on the R-OUT pin. It compares this voltage against the voltage on the HP-SENSE pin. When these voltages are equal, BTL mode is selected and AMP3 is shutdown and its output has a very high impedance. When the comparator's input signals are different, (a typical ΔV of 200mV), the comparator's output switches and activates the SE (headphone) mode. AMP3 changes from shutdown state to an active state and, along with AMP1, drives a stereo load. AMP2 drives the headphone jack sleeve.

Figure 3 shows the suggested headphone jack electrical connections. The jack is designed to mate with a three-wire plug. The plug's tip should carry a stereo signal's left-channel information. The ring adjacent to the tip should each carry the right-channel signal and the ring furthest from the tip provides the return to AMP2. A switch can replace the headphone jack contact pin. When the switch shorts the HP-SENSE pin to R-OUT, the bridge-connected speaker is driven by AMP1 and AMP2. AMP3 is shutdown, its output in a high-impedance state. When the switch opens, the LM4854 operates in SE stereo mode. If headphone drive is not needed, short the HP-SENSE pin to the R-OUT pin.

The LM4854's unique headphone sense circuit requires a dual switch headphone jack. A five-terminal headphone jack, such as the Switchcraft 35RAPC4BH3, is shown in Figure 2. For applications that require an SPDIF interface in the stereo headphone jack, use a Foxconn 2F1138-TJ-TR.

Application Information (Continued)

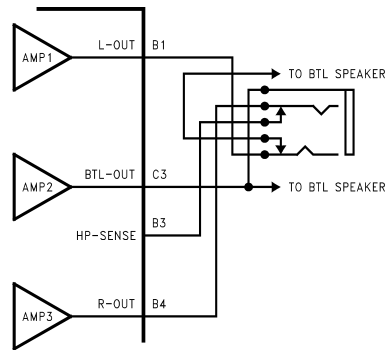

20038212

FIGURE 3. Headphone Circuit

Figure 4 shows an optional resistor connected between the amplifier output that drives the headphone jack sleeve and ground. This resistor provides a ground path that suppressed power supply hum. This hum may occur in applications such as notebook computers in a shutdown condition and connected to an external powered speaker. The resistor's 100Ω value is a suggested starting point. Its final value must be determined based on the tradeoff between the amount of noise suppression that may be needed and minimizing the additional current drawn by the resistor (25mA for a 100Ω resistor and a 5V supply).

Single-Ended Output Power Performance and Measurement Considerations

The LM4854 delivers clean, low distortion SE output power into loads that are greater than 10Ω. As an example, output power for 16Ω and 32Ω loads are shown in the Typical Performance Characteristic curves. For loads less than 10Ω, the LM4854 can typically supply 180mW of low distortion power. However, when higher dissipation is desired in loads less than 10Ω, a dramatic increase in THD+N may occur. This is normal operation and does not indicate that proper functionality has ceased. When a jump from moderate to excessively high distortion is seen, simply reducing the output voltage swing will restore the clean, low distortion SE operation.

The dramatic jump in distortion for loads less than 10Ω occurs when current limiting circuitry activates. During SE operation, AMP2 (refer to Figure 2) drives the headphone sleeve. An on-board circuit monitors this amplifier's output current. The sudden increase in THD+N is caused by the current limit circuitry forcing AMP2 into a high-impedance output mode. When this occurs, the output waveform has discontinuities that produce large amounts of distortion. It has been observed that as the output power is steadily increased, the distortion may jump from 5% to greater than 35%. Indeed, 10% THD+N may not actually be achievable.

ESD Protection

As stated in the Absolute Maximum Ratings, the AMP2 output pin has a maximum ESD susceptibility rating of 8000V. For higher ESD voltages, the addition of a PCDN042 dual transient (from California Micro Devices), as shown in Figure 4, will provide additional protection.

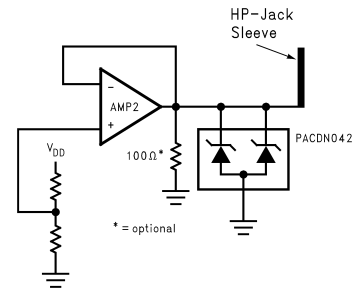

200382E8

FIGURE 4. The PCDN042 provides additional ESD protection beyond the 8000V shown in the Absolute Maximum Ratings for the AMP2 output

SELECTING EXTERNAL COMPONENTS

Input Capacitor Value Selection

Amplifying the lowest audio frequencies requires high value input coupling capacitor (C_i in Figure 2). A high value capacitor can be expensive and may compromise space efficiency in portable designs. In many cases, however, the speakers used in portable systems, whether internal or external, have little ability to reproduce signals below 150Hz. Applications using speakers with this limited frequency response reap little improvement by using large input capacitor.

The LM4854's advanced output transient suppression circuitry has eliminated the need to select the input capacitor's value in relation to the BYPASS capacitor's value as was necessary in some previous Boomer amplifiers. The value of C_i is now strictly determined by the desired low frequency response.

As shown in Figure 2, the input resistor (R_i) and the input capacitor (C_i) produce a high pass filter cutoff frequency that is found using Equation (7).

$$f_c = 1 / (2\pi R_i C_i) \quad (7)$$

As an example when using a speaker with a low frequency limit of 150Hz, C_i , using Equation (7) is 0.063μF. The 1.0μF C_i shown in Figure 2 allows the LM4854 to drive high efficiency, full range speaker whose response extends below 30Hz.

Bypass Capacitor Value Selection

Besides minimizing the input capacitor size, careful consideration should be paid to value of C_B , the capacitor connected to the BYPASS pin. Since C_B determines how fast the LM4854 settles to quiescent operation, its value is critical when minimizing turn-on pops. The slower the LM4854's outputs ramp to their quiescent DC voltage (nominally $V_{DD}/2$), the smaller the turn-on pop. Choosing C_B equal to 1.0μF along with a small value of C_i (in the range of 0.1μF to 0.39μF), produces a click-less and pop-less shutdown function. As discussed above, choosing C_i no larger than necessary for the desired bandwidth helps minimize clicks and pops. C_B 's value should be in the range of 5 times to 7 times the value of C_i . This ensures that output transients are eliminated when power is first applied or the LM4854 resumes operation after shutdown.

Application Information (Continued)

OPTIMIZING CLICK AND POP REDUCTION PERFORMANCE

The LM4854 contains circuitry that eliminates turn-on and shutdown transients ("clicks and pops") and transients that could occur when switching between BTL speakers and single-ended headphones. For this discussion, turn-on refers to either applying the power supply voltage or when the micro-power shutdown mode is deactivated.

As the $V_{DD}/2$ voltage present at the BYPASS pin ramps to its final value, the LM4854's internal amplifiers are configured as unity gain buffers and are disconnected from the L-OUT, BTL-OUT, and R-OUT pins. An internal current source charges the capacitor connected between the BYPASS pin and GND in a controlled, linear manner. Ideally, the input and outputs track the voltage applied to the BYPASS pin. The gain of the internal amplifiers remains unity until the voltage on the bypass pin reaches $V_{DD}/2$. Once the voltage on the bypass pin is stable and after a fixed nominal delay of 120ms, the device becomes fully operational and the amplifier outputs are reconnected to their respective output pins. Although the BYPASS pin current cannot be modified, changing the size of CB alters the device's turn-on time. There is a linear relationship between the size of CB and the turn-on time. Here are some typical turn-on times for various values of CB:

C_B (μF)	T_{ON} (ms)
0.01	120
0.1	130
0.22	140
0.47	160
1.0	200
2.2	300

In order to eliminate "clicks and pops", all capacitors must be discharged before turn-on. Rapidly switching V_{DD} may not allow the capacitors to fully discharge, which may cause "clicks and pops".

AUDIO POWER AMPLIFIER DESIGN

Audio Amplifier Design: Driving 1W into an 8 Ω Load

The following are the desired operational parameters:

- Power Output: $1W_{RMS}$
- Load Impedance: 8Ω
- Input Level: $1V_{RMS}$
- Input Impedance: $20k\Omega$
- Bandwidth: $100\text{Hz} - 20\text{kHz} \pm 0.25\text{dB}$

The design begins by specifying the minimum supply voltage necessary to obtain the specified output power. One way to find the minimum supply voltage is to use the Output Power vs Supply Voltage curve in the Typical Performance Characteristics section. Another way, using Equation (8), is to calculate the peak output voltage necessary to achieve the desired output power for a given load impedance. To account for the amplifier's dropout voltage, two additional voltages, based on the Dropout Voltage vs Supply Voltage in the Typical Performance Characteristics curves, must be added to the result obtained by Equation (8). The result is Equation (9).

$$V_{outpeak} = \sqrt{2R_L P_O} \quad (8)$$

$$V_{DD} = V_{OUTPEAK} + V_{ODTOP} + V_{ODBOT} \quad (9)$$

The Output Power vs. Supply Voltage graph for an 8 Ω load indicates a minimum supply voltage of 4.6V. The commonly used 5V supply voltage easily meets this. The additional voltage creates the benefit of headroom, allowing the LM4854 to produce peak output power in excess of 1W without clipping or other audible distortion. The choice of supply voltage must also not create a situation that violates of maximum power dissipation as explained above in the Power Dissipation section. After satisfying the LM4854's power dissipation requirements, the minimum differential gain needed to achieve 1W dissipation in an 8 Ω load is found using Equation (10).

$$A_{VD} \geq \frac{\sqrt{P_O R_L}}{V_{IN}} = \frac{V_{ORMS}}{V_{INRMS}} \quad (10)$$

Thus, a minimum gain of 2.83 allows the LM4854's to reach full output swing and maintain low noise and THD+N performance. For this example, let $AVD = 3$. The amplifier's overall gain is set using the input (R_i) and feedback (R_f) resistors. With the desired input impedance set at 20k Ω , the feedback resistor is found using Equation (11).

$$R_f / R_i = A_{VD} / 2 \quad (11)$$

The value of R_f is 30k Ω . The nominal output power is 1.13W. The last step in this design example is setting the amplifier's -3dB frequency bandwidth. To achieve the desired $\pm 0.25\text{dB}$ pass band magnitude variation limit, the low frequency response must extend to at least one-fifth the lower bandwidth limit and the high frequency response must extend to at least five times the upper bandwidth limit. The gain variation for both response limits is 0.17dB, well within the $\pm 0.25\text{dB}$ -desired limit. The results are an

$$f_L = 100\text{Hz} / 5 = 20\text{Hz} \quad (12)$$

and an

$$f_H = 20\text{kHz} \times 5 = 100\text{kHz} \quad (13)$$

As mentioned in the SELECTING EXTERNAL COMPONENTS section, R_i and C_i create a highpass filter that sets the amplifier's lower bandpass frequency limit. Find the coupling capacitor's value using Equation (14).

$$C_i = 1 / (2\pi R_i f_L) \quad (14)$$

The result is

$$1 / (2\pi \times 20\text{k}\Omega \times 20\text{Hz}) = 0.397\mu\text{F} \quad (15)$$

Use a 0.39 μF capacitor, the closest standard value.

Application Information (Continued)

The product of the desired high frequency cutoff (100kHz in this example) and the differential gain AVD, determines the upper passband response limit. With $AVD = 3$ and $f_H = 100\text{kHz}$, the closed-loop gain bandwidth product (GBWP) is 300kHz. This is less than the LM4854's 3.5MHz GBWP. With this margin, the amplifier can be used in designs that require more differential gain while avoiding performance restricting bandwidth limitations.

RECOMMENDED PRINTED CIRCUIT BOARD LAYOUT

Figures 5 through 9 show the recommended four-layer PC board layout that is optimized for the micro SMD-packaged LM4854 and associated external components. Figures 10

Demonstration Board Layout

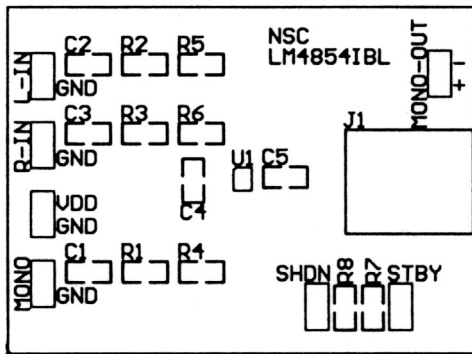

20038221

FIGURE 5. Recommended microSMD PC Board Layout:
Component-Side SilkScreen

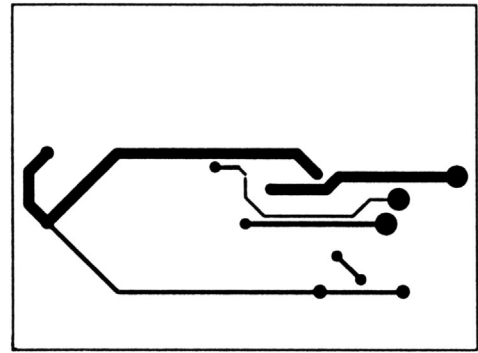

20038223

FIGURE 7. Recommended microSMD PC Board Layout:
Upper Inner-Layer Layout

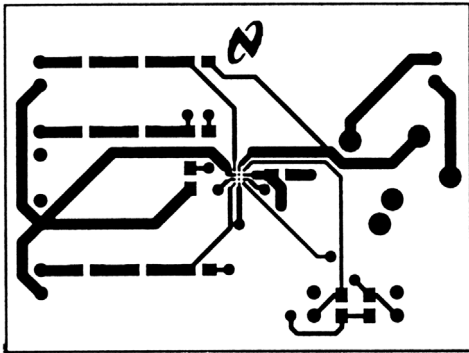

20038222

FIGURE 6. Recommended microSMD PC Board Layout:
Component-Side Layout

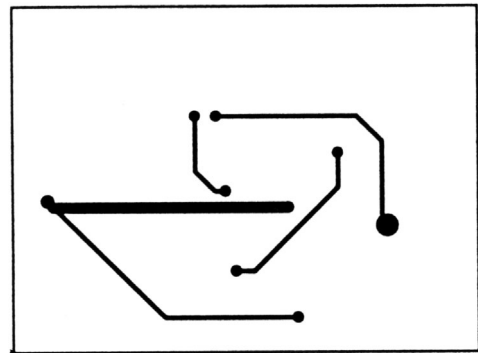

20038224

FIGURE 8. Recommended microSMD PC Board Layout:
Lower Inner-Layer Layout

through 12 show the recommended two-layer PC board layout that is optimized for the TSSOP-packaged LM4854 and associated external components. Figures 13 through 17 show the recommended four-layer PC board layout that is optimized for the LLP-packaged LM4854 and associated external components.

These circuits are designed for use with an external 5V supply and 8Ω (min) speakers. These circuit boards are easy to use. Apply 5V and ground to the board's V_{DD} and GND pads, respectively. Connect a speaker between the board's L-OUT and BTL-OUT or headphones to the headphone jack (L-OUT and R-OUT outputs).

Demonstration Board Layout

(Continued)



20038225

FIGURE 9. Recommended MM PC Board Layout: Bottom-Side Layout

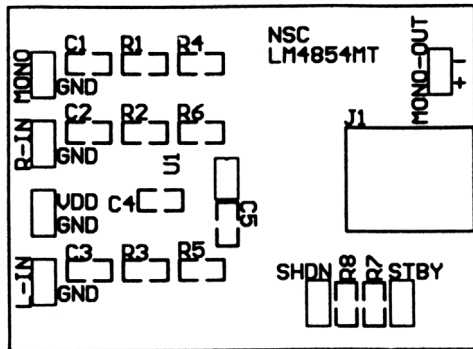

20038226

FIGURE 10. Recommended MT PC Board Layout: Component-Side SilkScreen

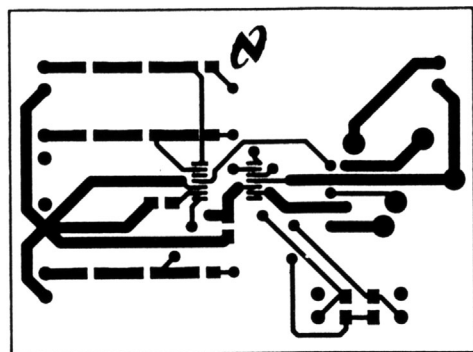

20038227

FIGURE 11. Recommended MT PC Board Layout: Component-Side Layout

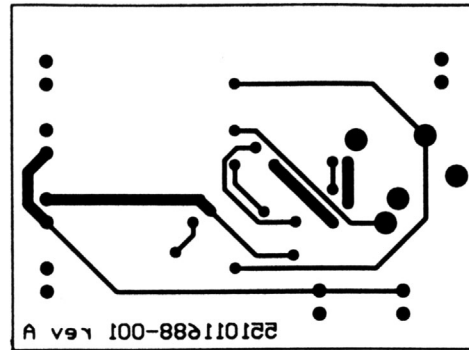

20038228

FIGURE 12. Recommended MT PC Board Layout: Bottom-Side Layout

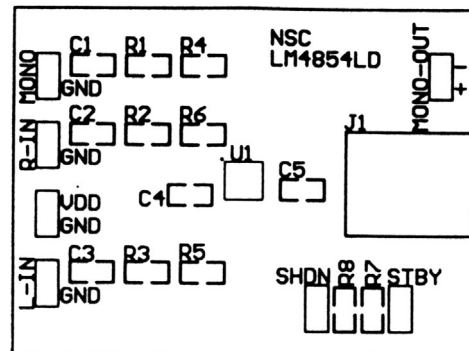

20038229

FIGURE 13. Recommended LD PC Board Layout: Component-Side SilkScreen

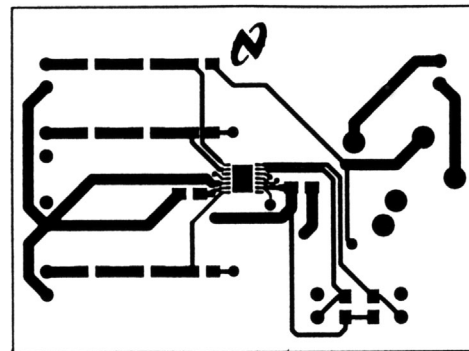

20038230

FIGURE 14. Recommended LD PC Board Layout: Component-Side Layout

Demonstration Board Layout (Continued)

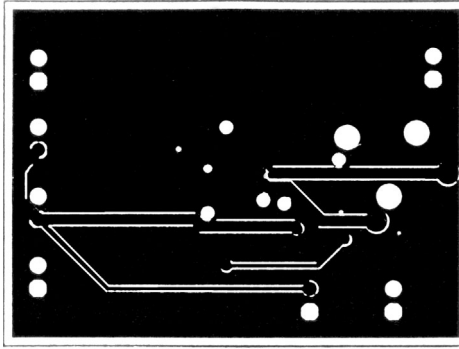

20038231

FIGURE 15. Recommended LD PC Board Layout:
Upper Inner-Layer Layout

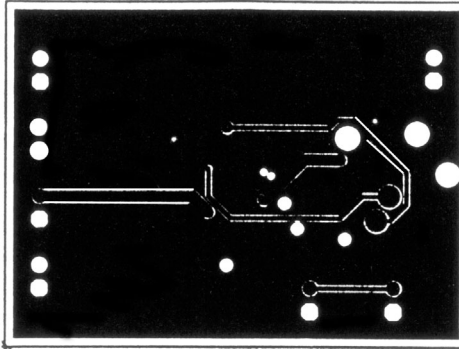

20038232

FIGURE 16. Recommended LD PC Board Layout:
Lower Inner-Layer Layout

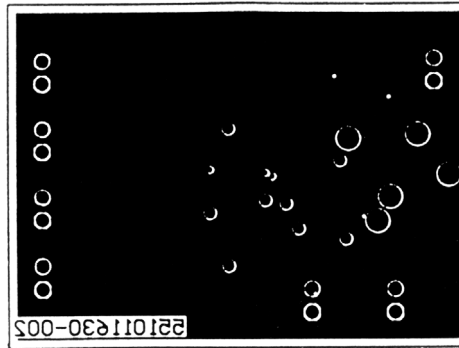

20038233

FIGURE 17. Recommended LD PC Board Layout:
Bottom-Side Layout

Physical Dimensions inches (millimeters) unless otherwise noted

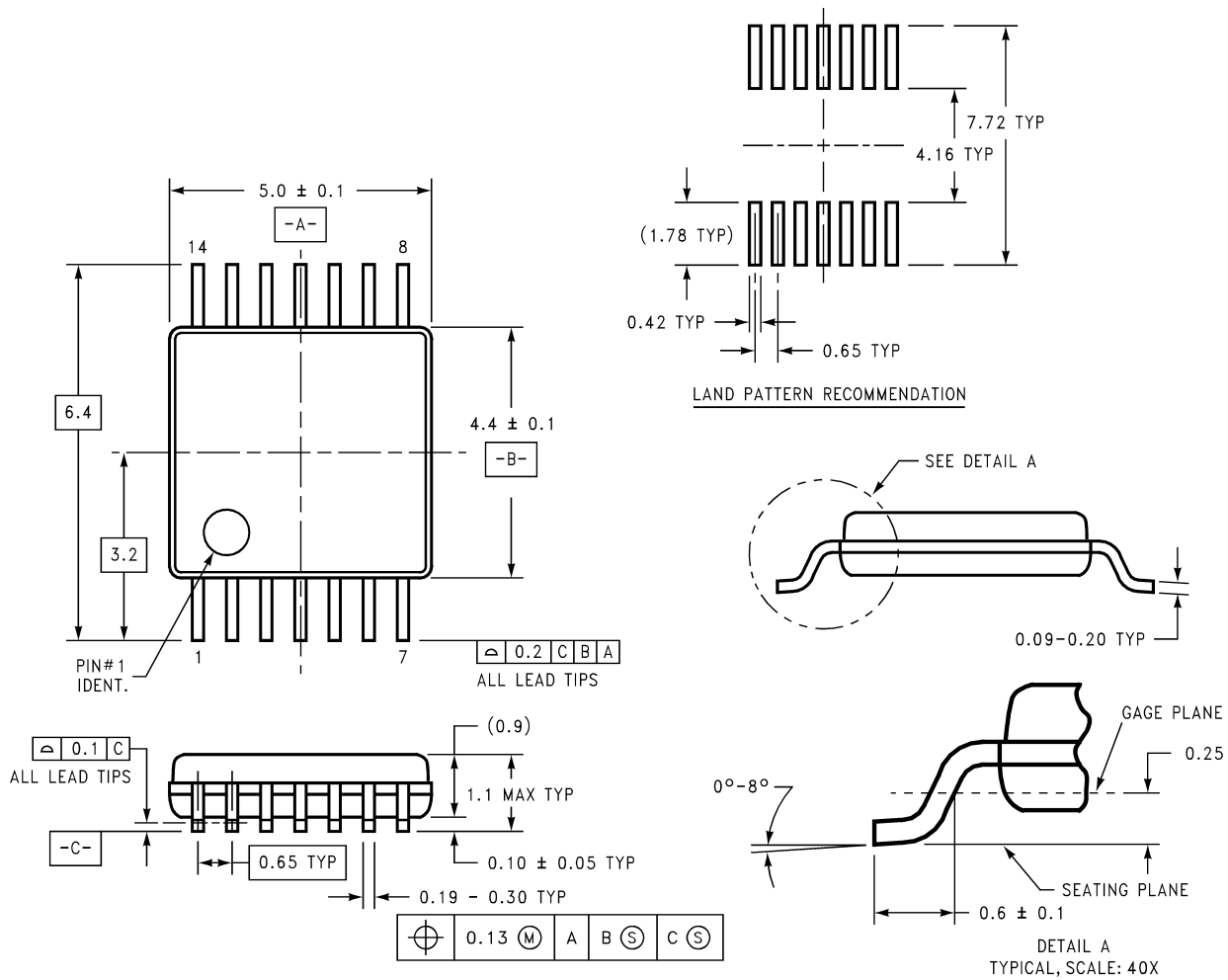

DIMENSIONS ARE IN MILLIMETERS

MTC14 (REV C)

TSSOP Package
Order Number LM4854MT
NS Package Number MTC14

Physical Dimensions inches (millimeters) unless otherwise noted (Continued)

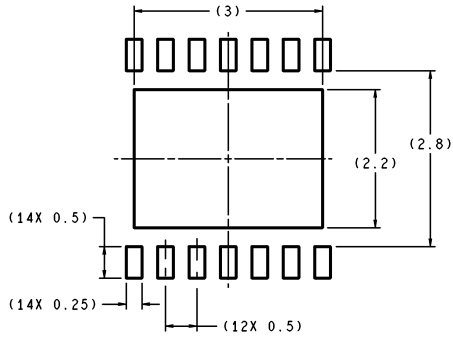

DIMENSIONS ARE IN MILLIMETERS

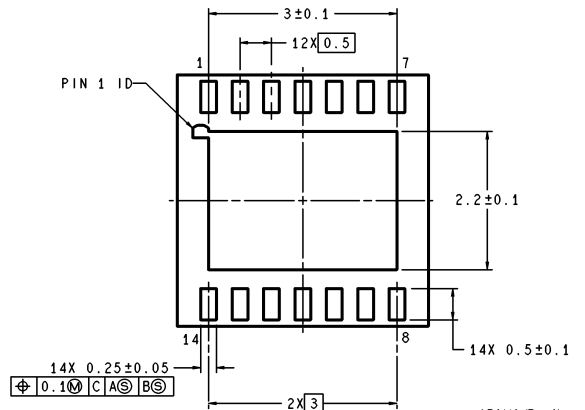
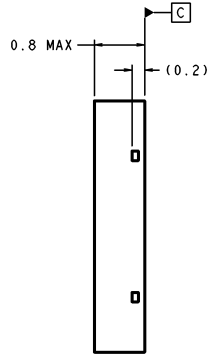
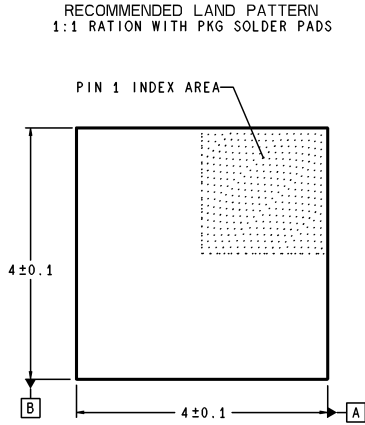

14-Lead LLP Package
Order Number LM4854LD
NS Package Number LDA14A

Physical Dimensions inches (millimeters) unless otherwise noted (Continued)

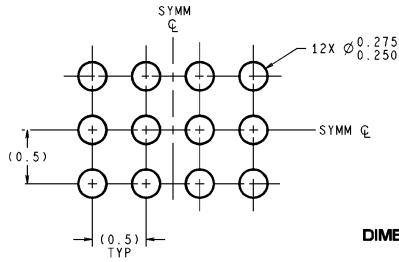

DIMENSIONS ARE IN MILLIMETERS

LAND PATTERN RECOMMENDATION

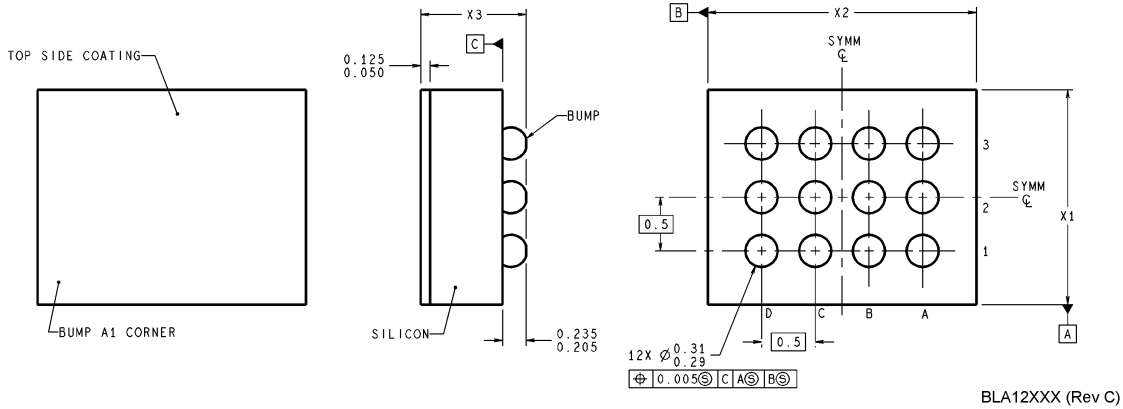

BLA12XXX (Rev C)

12-Bump micro SMD Package
Order Number LM4854IBL, LM4854IBLX
NS Package Number BLA12BAB
X1 = 1.539±0.03 X2 = 1.996±0.03 X3 = 0.945±0.10

LIFE SUPPORT POLICY

NATIONAL'S PRODUCTS ARE NOT AUTHORIZED FOR USE AS CRITICAL COMPONENTS IN LIFE SUPPORT DEVICES OR SYSTEMS WITHOUT THE EXPRESS WRITTEN APPROVAL OF THE PRESIDENT AND GENERAL COUNSEL OF NATIONAL SEMICONDUCTOR CORPORATION. As used herein:

1. Life support devices or systems are devices or systems which, (a) are intended for surgical implant into the body, or (b) support or sustain life, and whose failure to perform when properly used in accordance with instructions for use provided in the labeling, can be reasonably expected to result in a significant injury to the user.
2. A critical component is any component of a life support device or system whose failure to perform can be reasonably expected to cause the failure of the life support device or system, or to affect its safety or effectiveness.



National Semiconductor
Americas Customer Support Center
 Email: new.feedback@nsc.com
 Tel: 1-800-272-9959

National Semiconductor
Europe Customer Support Center
 Fax: +49 (0) 180-530 85 86
 Email: europe.support@nsc.com
 Deutsch Tel: +49 (0) 69 9508 6208
 English Tel: +44 (0) 870 24 0 2171
 Français Tel: +33 (0) 1 41 91 8790

National Semiconductor
Asia Pacific Customer Support Center
 Fax: +65-6250 4466
 Email: ap.support@nsc.com
 Tel: +65-6254 4466

National Semiconductor
Japan Customer Support Center
 Fax: 81-3-5639-7507
 Email: jpn.feedback@nsc.com
 Tel: 81-3-5639-7560

www.national.com