

# LM4912 Boomer® Audio Power Amplifier Series

## Stereo 40mW Low Noise Headphone Amplifier

### General Description

The LM4912 is an stereo audio power amplifier capable of delivering 40mW per channel of continuous average power into a 16Ω load or 25mW per channel into a 32Ω load at 1% THD from a 3V power supply.

Boomer audio power amplifiers were designed specifically to provide high quality output power with a minimal amount of external components. Since the LM4912 does not require bootstrap capacitors or snubber networks, it is optimally suited for low-power portable systems.

The LM4912 features a low-power consumption shutdown mode and a power mute mode that allows for faster turn on time with less than 1mV voltage change at outputs on release. Additionally, the LM4912 features an internal thermal shutdown protection mechanism.

The LM4912 is unity gain stable and may be configured with external gain-setting resistors.

### Key Specifications

- PSRR at 217 Hz and 1kHz 65dB (typ)
- Output Power at 1kHz with  $V_{DD} = 2.4V$ , 1% THD+N into a 16Ω load 25mW (typ)
- Output Power at 1kHz with  $V_{DD} = 3V$ , 1% THD+N into a 16Ω load 40mW (typ)
- Shutdown Current 1.0μA (max)
- Output Voltage change on release from Shutdown  $V_{DD} = 2.4V$ ,  $R_L = 16\Omega$  1mV (max)
- Output Noise, 20Hz to 20kHz, A-weighted 10μV (typ)

### Features

- External gain-setting capability
- Available in space-saving MSOP package
- Ultra low current shutdown mode
- Mute mode allows fast turn-on (10ms) with less than 1mV change on outputs
- 2.0V - 5.5V operation
- Ultra low noise
- Operation at low supply voltages

### Applications

- Portable CD players
- PDAs
- Portable electronics devices

### Typical Application

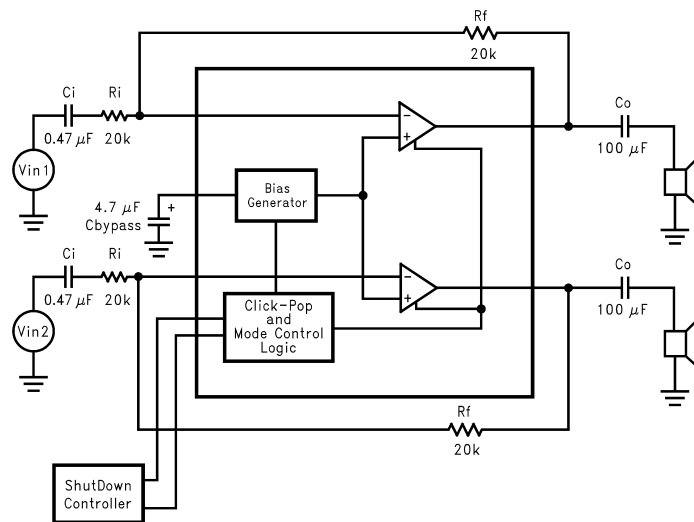

20048180

FIGURE 1. Typical Capacitive Coupled Output Configuration Circuit

Boomer® is a registered trademark of National Semiconductor Corporation.

# Connection Diagrams

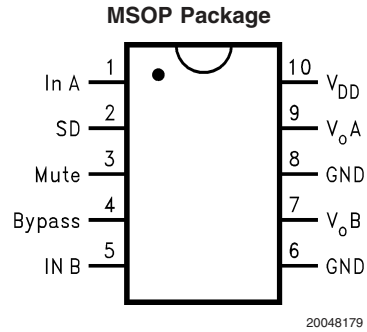

20048179

**Top View**  
**Order Number LM4912MM**  
**See NS Package Number MUB10A**

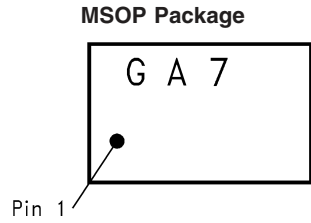

200481A9

**Top View**  
**G-Boomer Family**  
**A3 - LM4912MM**

**Absolute Maximum Ratings** (Note 2)

If Military/Aerospace specified devices are required, please contact the National Semiconductor Sales Office/Distributors for availability and specifications.

Supply Voltage	4.0V
Storage Temperature	-65°C to +150°C
Input Voltage	-0.3V to $V_{DD} + 0.3V$
Power Dissipation (Note 3)	Internally Limited
ESD Susceptibility (Note 4)	2000V
ESD Susceptibility (Note 5)	250V

Junction Temperature	150°C
Thermal Resistance	
$\theta_{JC}$ (MSOP)	56°C/W
$\theta_{JA}$ (MSOP)	190°C/W

**Operating Ratings**

Temperature Range	$-40^{\circ}\text{C} \leq T_A \leq 85^{\circ}\text{C}$
Supply Voltage ( $V_{DD}$ )	$2.0V \leq V_{DD} \leq 5.5V$

**Electrical Characteristics  $V_{DD} = 5.0V$**  (Notes 1, 2)

The following specifications apply for  $V_{DD} = 5.0V$ ,  $R_L = 16\Omega$ ,  $C_O = 100\mu\text{F}$ , and  $C_B = 4.7\mu\text{F}$  unless otherwise specified. Limits apply to  $T_A = 25^{\circ}\text{C}$ .

Symbol	Parameter	Conditions	LM4912		Units (Limits)
			Typ (Note 6)	Limit (Note 7)	
$I_{DD}$	Quiescent Power Supply Current	$V_{IN} = 0V, I_O = 0A$	2	5	mA (max)
$I_{SD}$	Shutdown Current	$V_{SHUTDOWN} = \text{GND}$	0.1	2.0	$\mu\text{A}$ (max)
$I_M$	Mute Current	$V_{MUTE} = V_{DD}$	2	5	mA (max)
$V_{SDIH}$	Shutdown Voltage Input High		1.8		V
$V_{SDIL}$	Shutdown Voltage Input Low		0.4		V
$V_{MIH}$	Mute Voltage Input High		1.8		V
$V_{MIL}$	Mute Voltage Input Low		0.4		V
$P_O$	Output Power	THD = 1%; f = 1kHz			mW
		R = 16 $\Omega$	145		
		R = 32 $\Omega$	80		
$V_{NO}$	Output Noise Voltage	BW = 20 Hz to 20kHz, A-weighted	10		$\mu\text{V}$
PSRR	Power Supply Rejection Ratio	$V_{RIPPLE} = 200\text{mV}$ sine p-p	65		dB
$A_M$	Mute Attenuation	f = 1kHz	85		dB

**Electrical Characteristics  $V_{DD} = 3.0V$**  (Notes 1, 2)

The following specifications apply for  $V_{DD} = 3.0V$ ,  $R_L = 16\Omega$ ,  $C_O = 100\mu\text{F}$ , and  $C_B = 4.7\mu\text{F}$  unless otherwise specified. Limits apply to  $T_A = 25^{\circ}\text{C}$ .

Symbol	Parameter	Conditions	LM4912		Units (Limits)
			Typ (Note 6)	Limit (Note 7)	
$I_{DD}$	Quiescent Power Supply Current	$V_{IN} = 0V, I_O = 0A$	1.5	3	mA (max)
$I_{SD}$	Shutdown Current	$V_{SHUTDOWN} = \text{GND}$	0.1	2.0	$\mu\text{A}$ (max)
$I_M$	Mute Current	$V_{MUTE} = V_{DD}$	1.5	3	mA (max)
$P_O$	Output Power	THD = 1%; f = 1kHz			mW
		R = 16 $\Omega$	40		
		R = 32 $\Omega$	25		
$V_{NO}$	Output Noise Voltage	BW = 20 Hz to 20kHz, A-weighted	10		$\mu\text{V}$
PSRR	Power Supply Rejection Ratio	$V_{RIPPLE} = 200\text{mV}$ sine p-p	65		dB
$A_M$	Mute Attenuation	f = 1kHz	80		dB

## Electrical Characteristics $V_{DD} = 2.4V$ (Notes 1, 2)

The following specifications apply for  $V_{DD} = 2.4V$ ,  $R_L = 16\Omega$ ,  $C_O = 100\mu F$ , and  $C_B = 4.7\mu F$  unless otherwise specified. Limits apply to  $T_A = 25^\circ C$ .

Symbol	Parameter	Conditions	LM4912		Units (Limits)
			Typ (Note 6)	Limit (Note 7)	
$I_{DD}$	Quiescent Power Supply Current	$V_{IN} = 0V$ , $I_O = 0A$	1.5	3	mA (max)
$I_{SD}$	Shutdown Current	$V_{SHUTDOWN} = GND$	0.1	2.0	$\mu A$ (max)
$I_M$	Mute Current	$V_{MUTE} = V_{DD}$	1.5	3	mA (max)
$P_O$	Output Power	THD = 1%; $f = 1kHz$			mW
		$R = 16\Omega$	25		
		$R = 32\Omega$	12		
$V_{NO}$	Output Noise Voltage	BW = 20 Hz to 20kHz, A-weighted	10		$\mu V$
PSRR	Power Supply Rejection Ratio	$V_{RIPPLE} = 200mV$ sine p-p	65		dB
$T_{WU}$	Wake Up Time from Shutdown		2		s
$V_{OSD}$	Output Voltage Change on Release from Shutdown			1	mV (max)
$T_{UM}$	Time to Un-Mute		0.01	0.02	s (max)
$A_M$	Mute Attenuation	$f = 1kHz$	80		db

**Note 1:** All voltages are measured with respect to the GND pin unless otherwise specified.

**Note 2:** : Absolute Maximum Ratings indicate limits beyond which damage to the device may occur. Operating Ratings indicate conditions for which the device is functional but do not guarantee specific performance limits. Electrical Characteristics state DC and AC electrical specifications under particular test conditions which guarantee specific performance limits. This assumes that the device is within the Operating Ratings. Specifications are not guaranteed for parameters where no limit is given, however, the typical value is a good indication of device performance.

**Note 3:** : The maximum power dissipation must be derated at elevated temperatures and is dictated by  $T_{JMAX}$ ,  $\theta_{JA}$ , and the ambient temperature,  $T_A$ . The maximum allowable power dissipation is  $P_{DMAX} = (T_{JMAX} - T_A) / \theta_{JA}$  or the number given in Absolute Maximum Ratings, whichever is lower. For the LM4912, see power derating currents for more information.

**Note 4:** Human body model, 100pF discharged through a 1.5k $\Omega$  resistor.

**Note 5:** Machine Model, 220pF-240pF discharged through all pins.

**Note 6:** Typical values are measured at 25 $^\circ C$  and represent the parametric norm.

**Note 7:** Limits are guaranteed to National's AOQL (Average Outgoing Quality Level).

**Note 8:** Datasheet min/max specification limits are guaranteed by design, test, or statistical analysis.

**Note 9:** 10 $\Omega$  Terminated input.

## External Components Description See (Figure 1)

Components	Functional Description
1. $R_i$	Inverting input resistance which sets the closed-loop gain in conjunction with $R_f$ . This resistor also forms a high-pass filter with $C_i$ at $f_c = 1/(2\pi R_i C_i)$ .
2. $C_i$	Input coupling capacitor which blocks the DC voltage at the amplifier's input terminals. Also creates a high-pass filter with $R_i$ at $f_c = 1/(2\pi R_i C_i)$ . Refer to the section <b>Proper Selection of External Components</b> , for an explanation of how to determine the value of $C_i$ .
3. $R_f$	Feedback resistance which sets the closed-loop gain in conjunction with $R_i$ .
4. $C_S$	Supply bypass capacitor which provides power supply filtering. Refer to the <b>Power Supply Bypassing</b> section for information concerning proper placement and selection of the supply bypass capacitor.
5. $C_B$	Bypass pin capacitor which provides half-supply filtering. Refer to the section, <b>Proper Selection of Proper Components</b> , for information concerning proper placement and selection of $C_B$ .
6. $C_O$	Output coupling capacitor which blocks the DC voltage at the amplifier's output. Forms a high pass filter with $R_L$ at $f_o = 1/(2\pi R_L C_O)$ .

# Typical Performance Characteristics

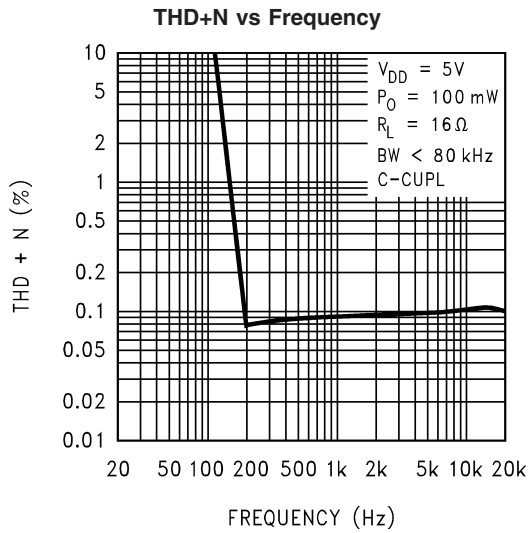

20048184

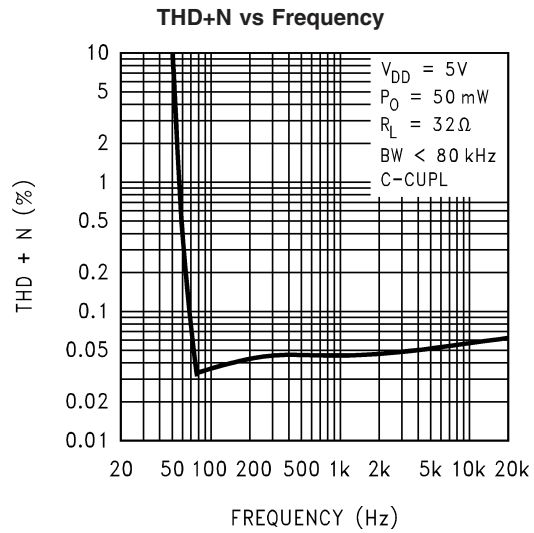

20048185

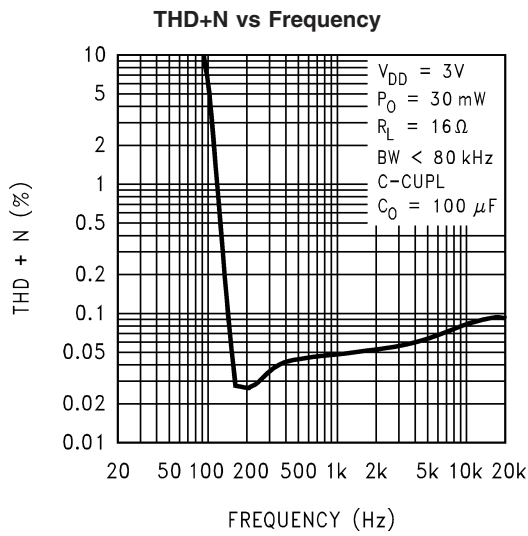

20048186

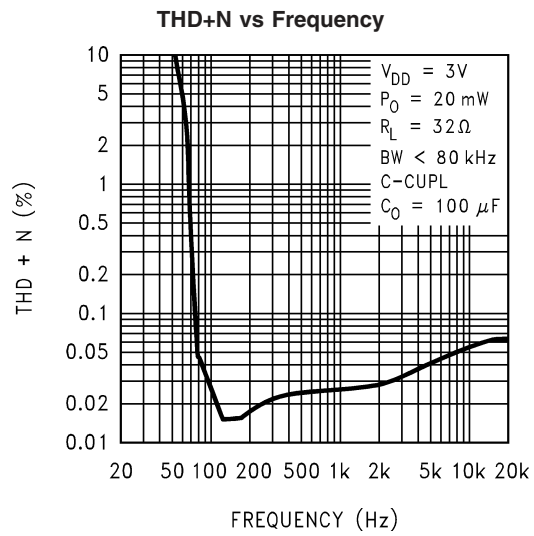

20048187

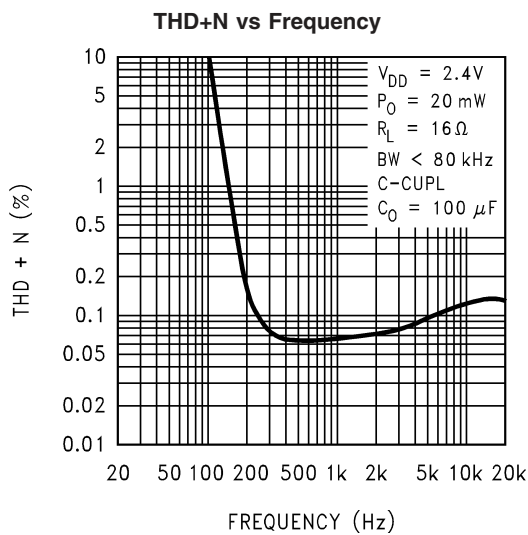

20048188

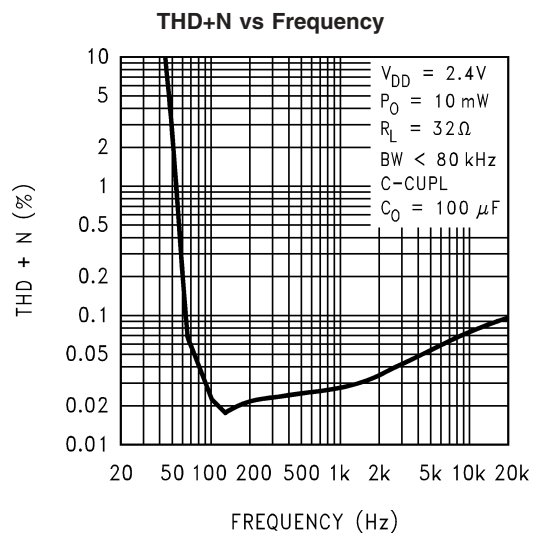

20048189

Typical Performance Characteristics (Continued)

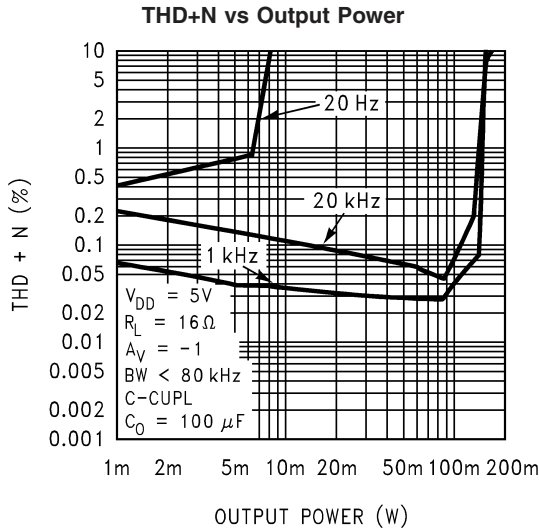

20048190

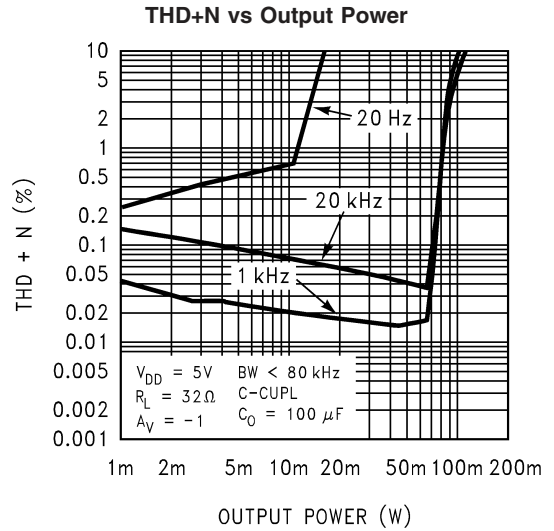

20048191

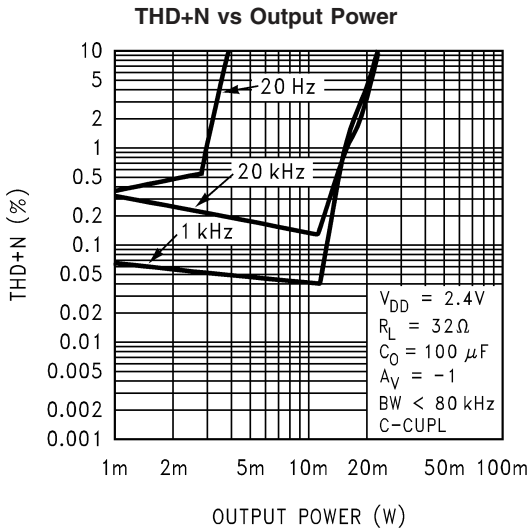

20048108

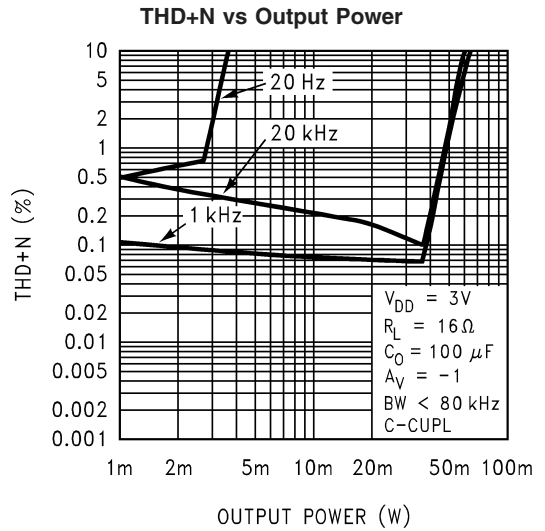

20048107

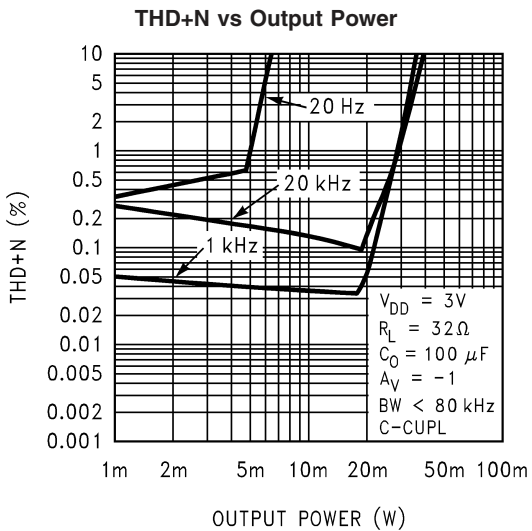

20048110

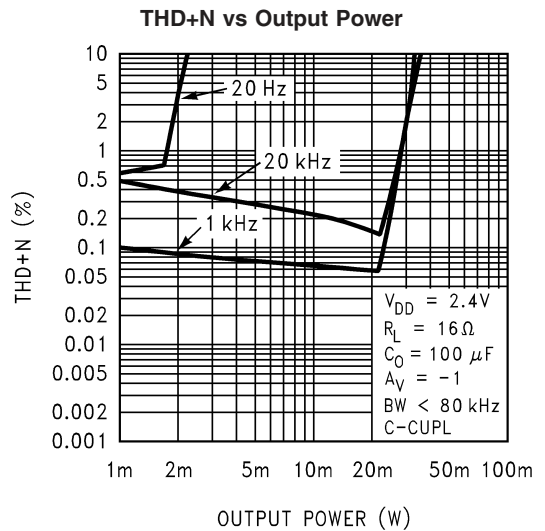

20048109

# Typical Performance Characteristics (Continued)

Output Resistance vs Load Resistance

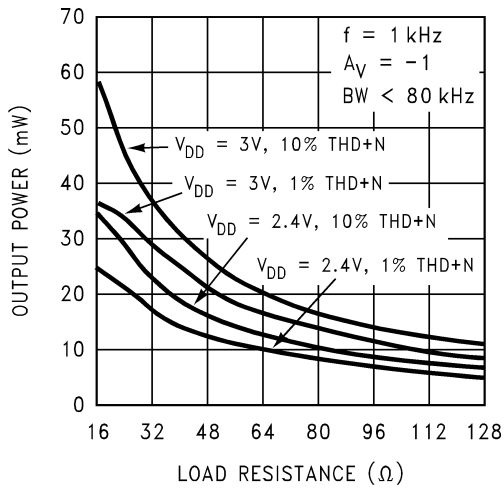

20048113

Output Power vs Supply Voltage

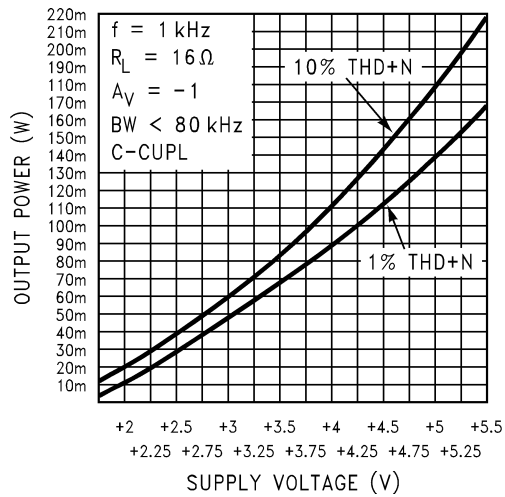

20048112

Output Power vs Supply Voltage

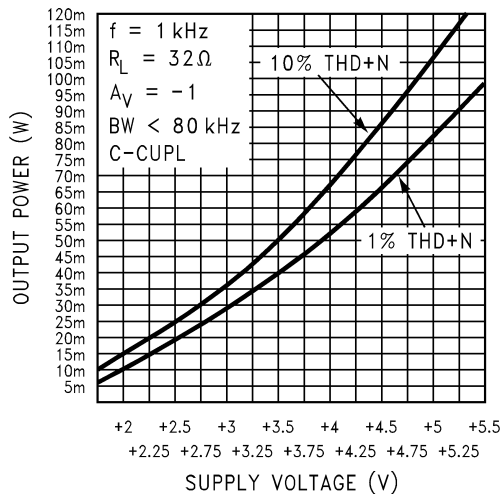

20048111

Output Power vs Load Resistance

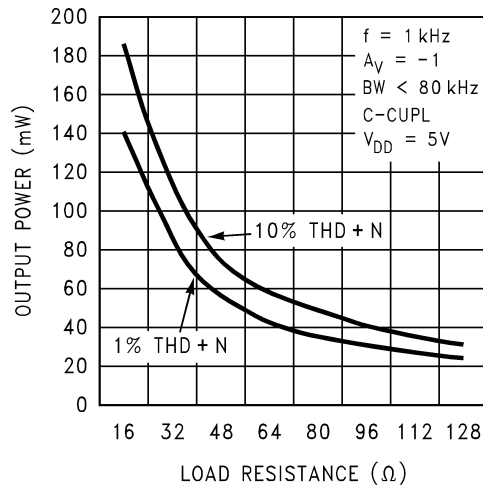

20048196

Power Dissipation vs. Output Power

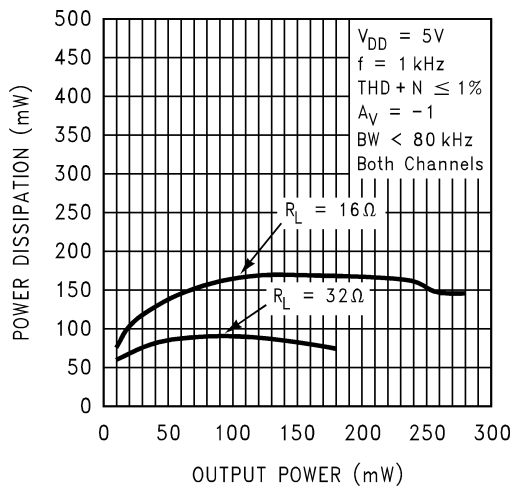

20048198

Power Dissipation vs. Output Power

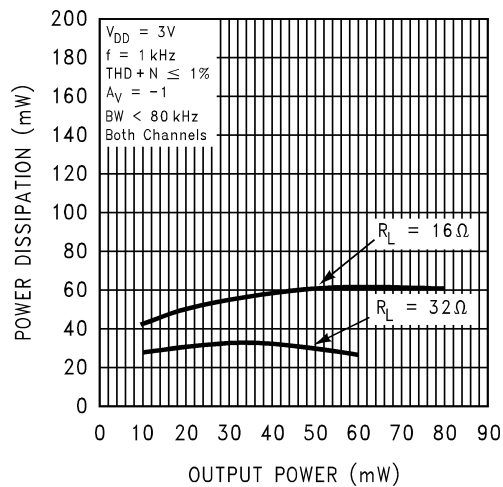

20048199

# Typical Performance Characteristics (Continued)

**Power Dissipation vs Output Power**

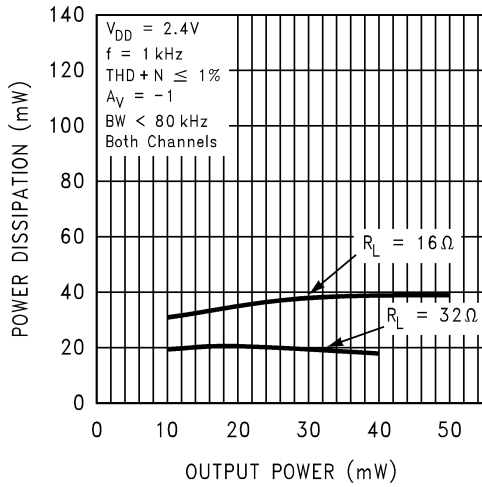

200481A0

**Channel Separation**

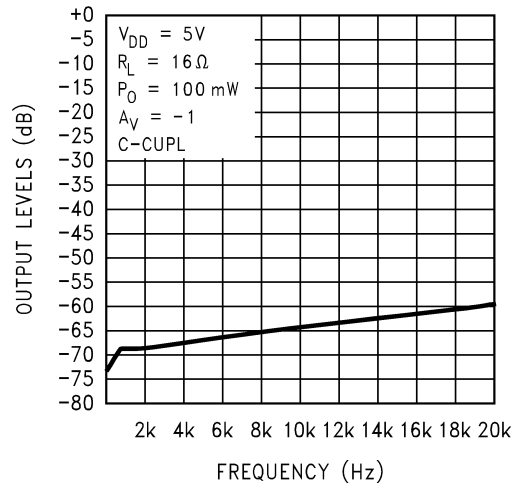

200481A1

**Channel Separation**

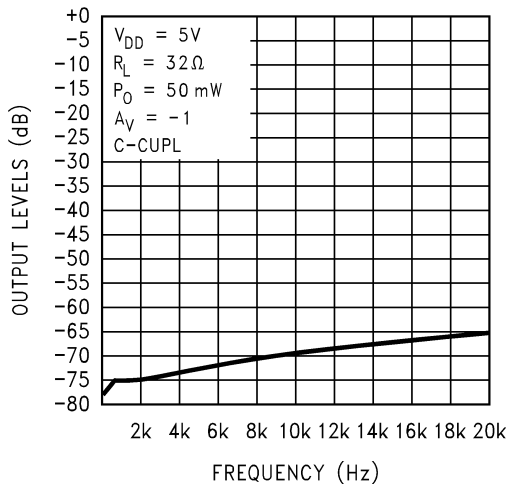

200481A2

**Channel Separation**

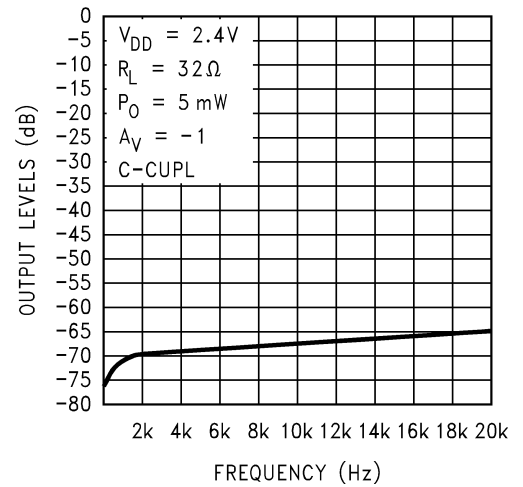

20048117

**Channel Separation**

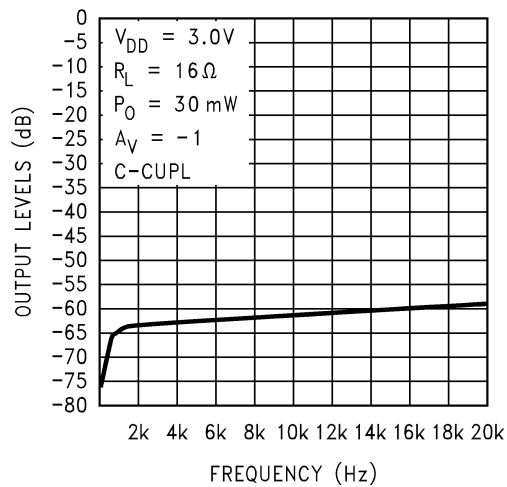

20048119

**Channel Separation**

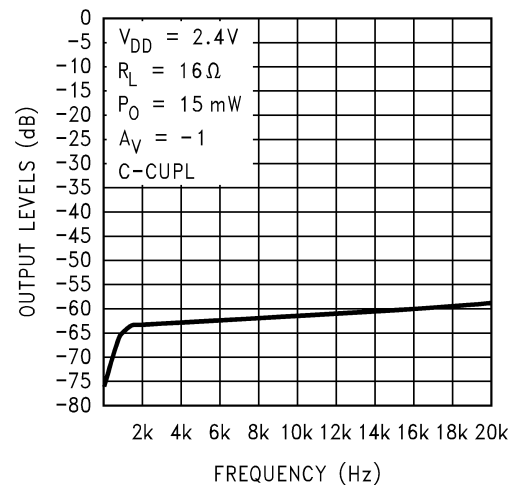

20048118



Typical Performance Characteristics (Continued)

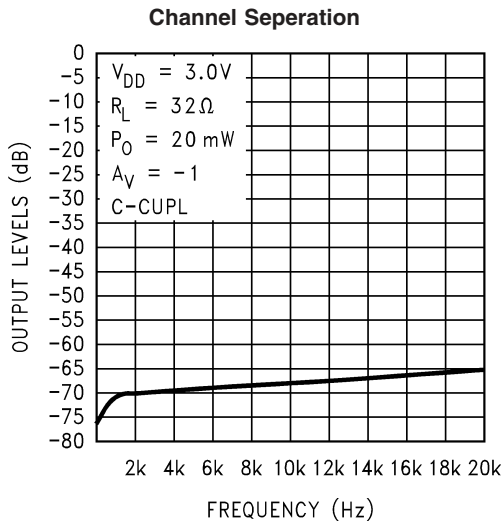

20048116

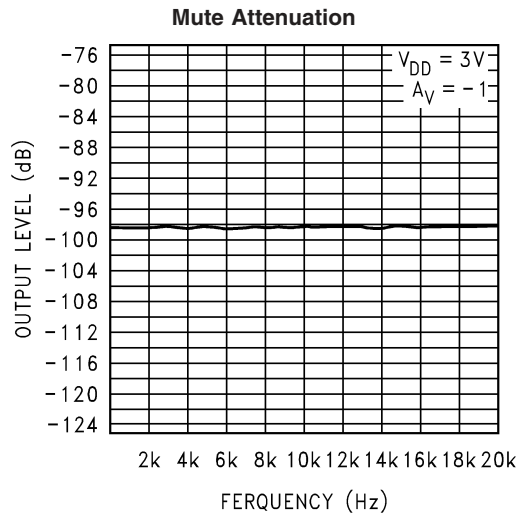

200481B4

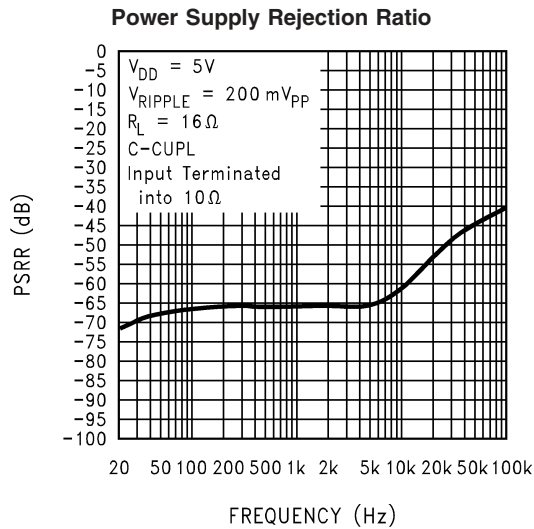

200481A3

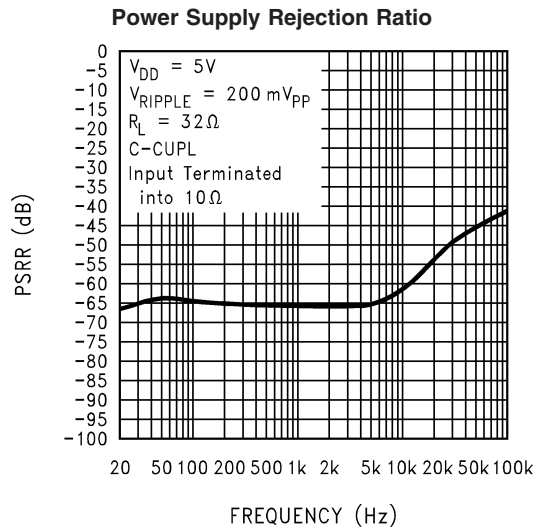

200481A4

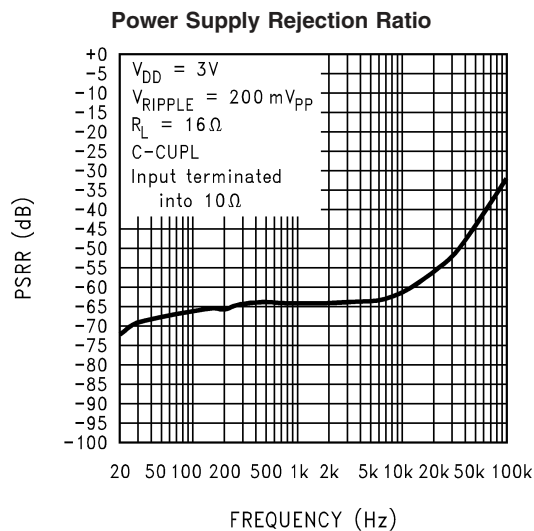

20048120

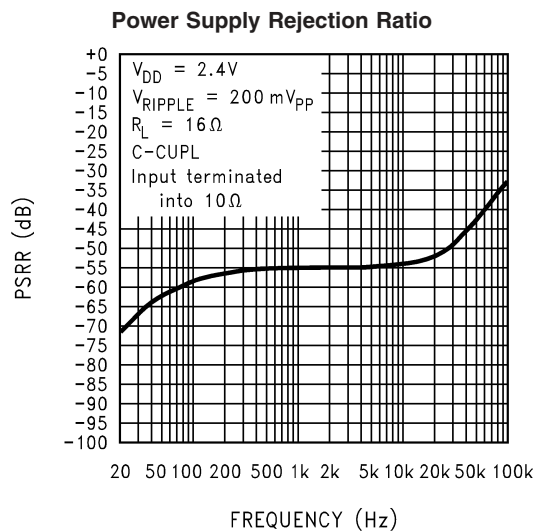

20048123

Typical Performance Characteristics (Continued)

Power Supply Rejection Ratio

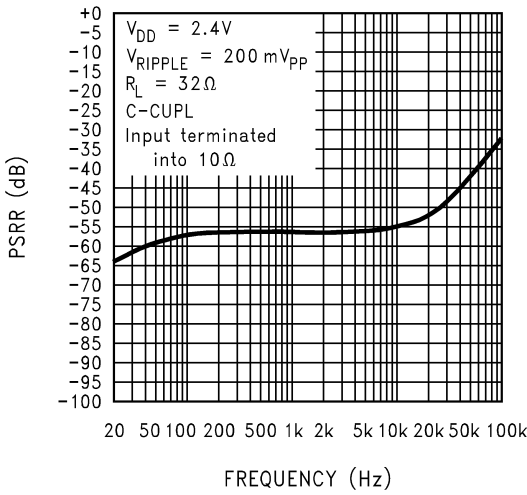

20048121

Power Supply Rejection Ratio

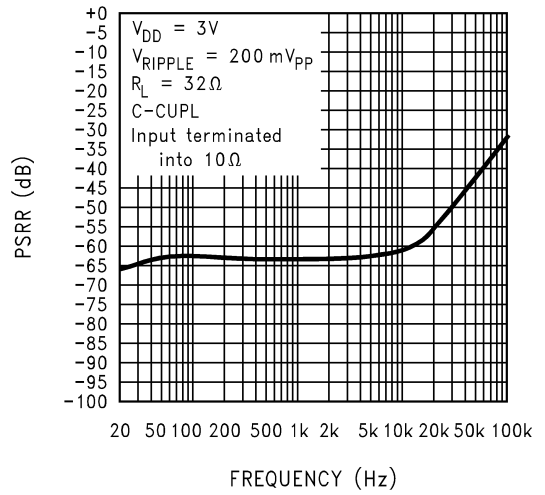

20048122

Frequency Response vs Input Capacitor Size

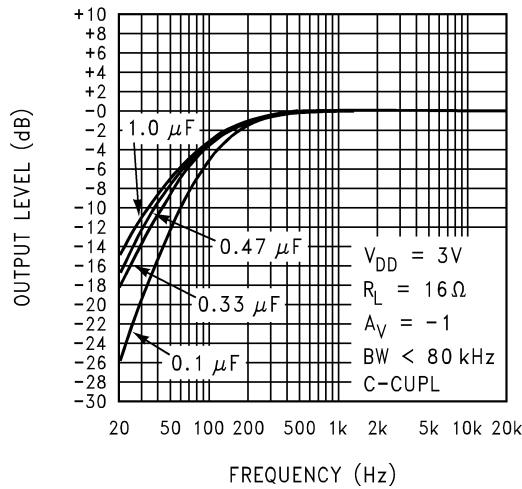

20048127

Open Loop Frequency Response

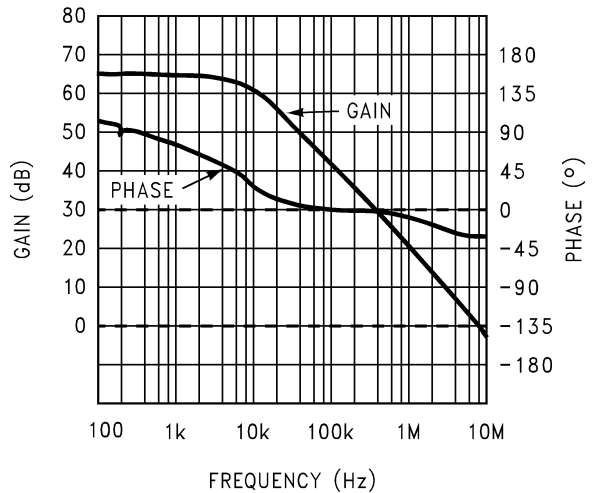

200481A7

Supply Voltage vs Supply Current

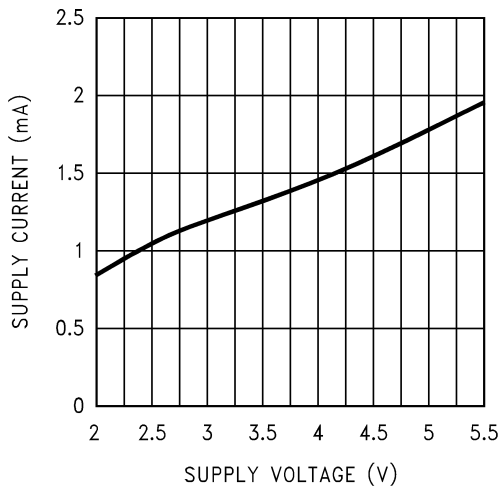

20048124

Clipping Voltage vs Supply Voltage

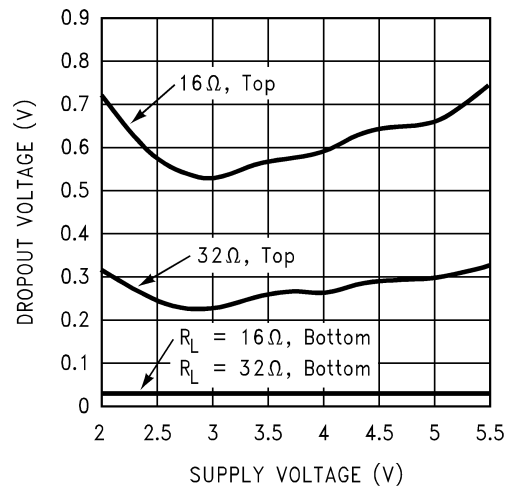

20048125

# Typical Performance Characteristics (Continued)

**Noise Floor**

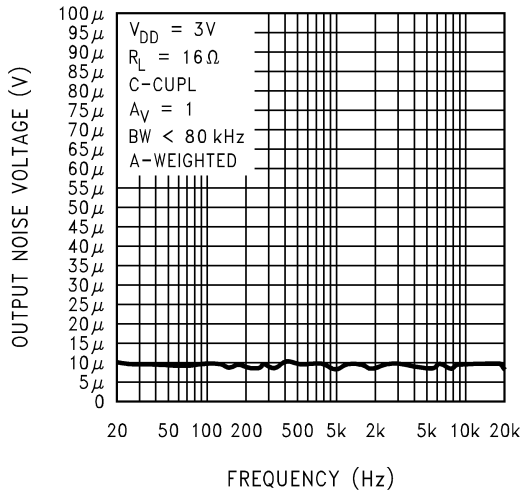

200481A8

**Shutdown Hysteresis Voltage, Vdd=5V**

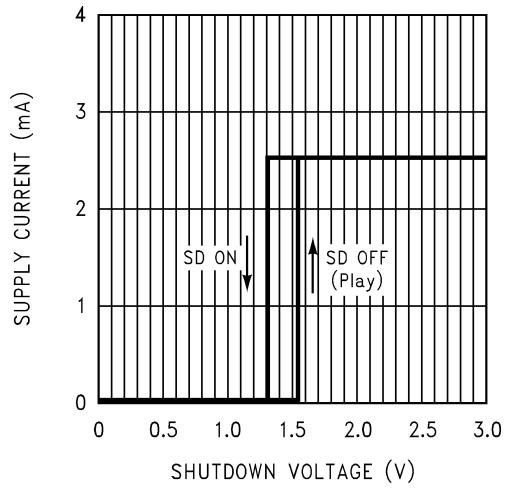

200481B1

**Shutdown Hysteresis Voltage, Vdd=3V**

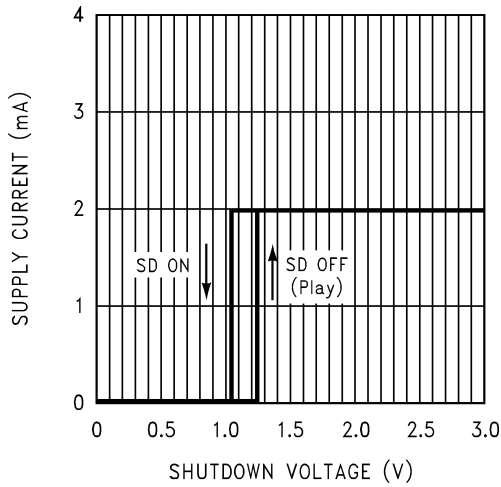

200481B2

**Power Derating Curve**

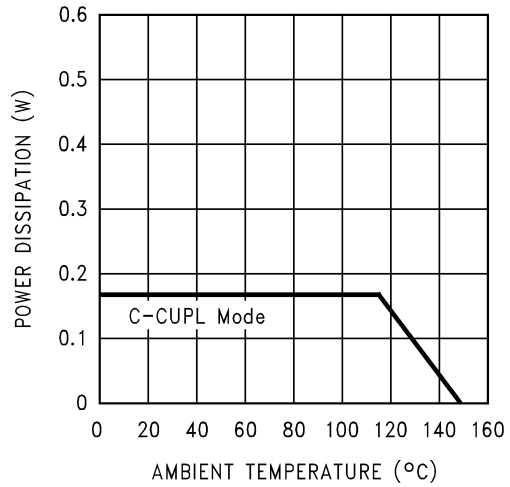

200481B3

## Application Information

### AMPLIFIER CONFIGURATION EXPLANATION

As shown in Figure 1, the LM4912 has three operational amplifiers internally. Two of the amplifier's have externally configurable gain while the other amplifier is internally fixed at the bias point acting as a unity-gain buffer. The closed-loop gain of the two configurable amplifiers is set by selecting the ratio of  $R_f$  to  $R_i$ . Consequently, the gain for each channel of the IC is

$$A_{VD} = -(R_f / R_i)$$

By driving the loads through outputs  $V_{oA}$  and  $V_{oB}$  with  $V_{oC}$  acting as a buffered bias voltage the LM4912 does not require output coupling capacitors. The classical single-ended amplifier configuration where one side of the load is connected to ground requires large, expensive output coupling capacitors.

A configuration, such as the one used in the LM4912, has a major advantage over single supply, single-ended amplifiers. Since the outputs  $V_{oA}$ ,  $V_{oB}$ , and  $V_{oC}$  are all biased at  $1/2 V_{DD}$ , no net DC voltage exists across each load. This eliminates the need for output coupling capacitors which are required in a single-supply, single-ended amplifier configuration. Without output coupling capacitors in a typical single-supply, single-ended amplifier, the bias voltage is placed across the load resulting in both increased internal IC power dissipation and possible loudspeaker damage.

### POWER DISSIPATION

Power dissipation is a major concern when using any power amplifier and must be thoroughly understood to ensure a successful design. When operating in capacitor-coupled mode, Equation 1 states the maximum power dissipation point for a single-ended amplifier operating at a given supply voltage and driving a specified output load.

$$P_{DMAX} = (V_{DD})^2 / (2\pi^2 R_L) \quad (1)$$

Since the LM4912 has two operational amplifiers in one package, the maximum internal power dissipation point is twice that of the number which results from Equation 1. From Equation 1, assuming a 3V power supply and a  $32\Omega$  load, the maximum power dissipation point is 14mW per amplifier. Thus the maximum package dissipation point is 28mW.

The maximum power dissipation point obtained from Equation 1 must not be greater than the power dissipation that results from Equation 2:

$$P_{DMAX} = (T_{JMAX} - T_A) / \theta_{JA} \quad (2)$$

For package MUB10A,  $\theta_{JA} = 190^\circ\text{C/W}$ .  $T_{JMAX} = 150^\circ\text{C}$  for the LM4912. Depending on the ambient temperature,  $T_A$ , of the system surroundings, Equation 2 can be used to find the maximum internal power dissipation supported by the IC packaging. If the result of Equation 1 is greater than that of Equation 2, then either the supply voltage must be decreased, the load impedance increased or  $T_A$  reduced. For the typical application of a 3V power supply, with a  $32\Omega$  load, the maximum ambient temperature possible without violating the maximum junction temperature is approximately

$144^\circ\text{C}$  provided that device operation is around the maximum power dissipation point. Thus, for typical applications, power dissipation is not an issue. Power dissipation is a function of output power and thus, if typical operation is not around the maximum power dissipation point, the ambient temperature may be increased accordingly. Refer to the Typical Performance Characteristics curves for power dissipation information for lower output powers.

### POWER SUPPLY BYPASSING

As with any amplifier, proper supply bypassing is important for low noise performance and high power supply rejection. The capacitor location on the power supply pins should be as close to the device as possible.

Typical applications employ a 3V regulator with 10mF tantalum or electrolytic capacitor and a ceramic bypass capacitor which aid in supply stability. This does not eliminate the need for bypassing the supply nodes of the LM4912. A bypass capacitor value in the range of  $0.1\mu\text{F}$  to  $1\mu\text{F}$  is recommended for  $C_S$ .

### MICRO POWER SHUTDOWN

The voltage applied to the SHUTDOWN pin controls the LM4912's shutdown function. Activate micro-power shutdown by applying a logic-low voltage to the SHUTDOWN pin. When active, the LM4912's micro-power shutdown feature turns off the amplifier's bias circuitry, reducing the supply current. The trigger point varies depending on supply voltage and is shown in the Shutdown Hysteresis Voltage graphs in the Typical Performance Characteristics section. The low  $0.1\mu\text{A}$ (typ) shutdown current is achieved by applying a voltage that is as near as possible to the SHUTDOWN pin. A voltage that is higher than ground may increase the shutdown current. There are a few ways to control the micro-power shutdown. These include using a single-pole, single-throw switch, a microprocessor, or a microcontroller. When using a switch, connect an external  $100\text{k}\Omega$  pull-up resistor between the SHUTDOWN pin and  $V_{DD}$ . Connect the switch between the SHUTDOWN pin and ground. Select normal amplifier operation by opening the switch. Closing the switch connects the SHUTDOWN pin to ground, activating micro-power shutdown.

The switch and resistor guarantee that the SHUTDOWN pin will not float. This prevents unwanted state changes. In a system with a microprocessor or microcontroller, use a digital output to apply the control voltage to the SHUTDOWN pin. Driving the SHUTDOWN pin with active circuitry eliminates the pull-up resistor.

Shutdown enable/disable times are controlled by a combination of  $C_B$  and  $V_{DD}$ . Larger values of  $C_B$  results in longer turn on/off times from Shutdown. Smaller  $V_{DD}$  values also increase turn on/off time for a given value of  $C_B$ . Longer shutdown times also improve the LM4912's resistance to click and pop upon entering or returning from shutdown. For a 2.4V supply and  $C_B = 4.7\mu\text{F}$ , the LM4912 requires about 2 seconds to enter or return from shutdown. This longer shutdown time enables the LM4912 to have virtually zero pop and click transients upon entering or release from shutdown.

Smaller values of  $C_B$  will decrease turn-on time, but at the cost of increased pop and click and reduced PSRR. Since shutdown enable/disable times increase dramatically as supply voltage gets below 2.2V, this reduced turn-on time may be desirable if extreme low supply voltage levels are used as this would offset increases in turn-on time caused by the lower supply voltage.

## Application Information (Continued)

### MUTE

When in C-CUPL mode, the LM4912 also features a mute function that is independent of load impedance and enables extremely fast turn-on/turn-off with a minimum of output pop and click. The mute function leaves the outputs at their bias level, thus resulting in higher power consumption than shutdown mode, but also provides much faster turn on/off times. Mute mode is enabled by providing a logic high signal on the MUTE pin in the opposite manner as the shutdown function described above. Threshold voltages and activation techniques match those given for the shutdown function as well. Additionally, Mute should not be enabled during shutdown or while entering or returning from shutdown. This is not a valid operation condition and may result in much higher pop and click values.

### PROPER SELECTION OF EXTERNAL COMPONENTS

Proper selection of external components in applications using integrated power amplifiers is critical to optimize device and system performance. While the LM4912 is tolerant of external component combinations, consideration to component values must be used to maximize overall system quality.

The LM4912 is unity-gain stable which gives the designer maximum system flexibility. The LM4912 should be used in low gain configurations to minimize THD+N values, and maximize the signal to noise ratio. Low gain configurations require large input signals to obtain a given output power. Input signals equal to or greater than  $1V_{rms}$  are available from sources such as audio codecs. Very large values should not be used for the gain-setting resistors. Values for  $R_i$  and  $R_f$  should be less than  $1M\Omega$ . Please refer to the section, **Audio Power Amplifier Design**, for a more complete explanation of proper gain selection.

Besides gain, one of the major considerations is the closed-loop bandwidth of the amplifier. To a large extent, the bandwidth is dictated by the choice of external components shown in Figures 2 and 3. The input coupling capacitor,  $C_i$ , forms a first order high pass filter which limits low frequency response. This value should be chosen based on needed frequency response and turn-on time.

### SELECTION OF INPUT CAPACITOR SIZE

Amplifying the lowest audio frequencies requires a high value input coupling capacitor,  $C_i$ . A high value capacitor can be expensive and may compromise space efficiency in portable designs. In many cases, however, the headphones used in portable systems have little ability to reproduce signals below 60Hz. Applications using headphones with this limited frequency response reap little improvement by using a high value input capacitor.

In addition to system cost and size, turn on time is affected by the size of the input coupling capacitor  $C_i$ . A larger input coupling capacitor requires more charge to reach its quiescent DC voltage. This charge comes from the output via the

feedback. Thus, by minimizing the capacitor size based on necessary low frequency response, turn-on time can be minimized. A small value of  $C_i$  (in the range of  $0.1\mu F$  to  $0.39\mu F$ ), is recommended.

### AUDIO POWER AMPLIFIER DESIGN

#### A 25mW/32 $\Omega$ Audio Amplifier

Given:

Power Output	25mWrms
Load Impedance	32 $\Omega$
Input Level	1Vrms
Input Impedance	20k $\Omega$

A designer must first determine the minimum supply rail to obtain the specified output power. By extrapolating from the Output Power vs Supply Voltage graphs in the **Typical Performance Characteristics** section, the supply rail can be easily found.

3V is a standard voltage in most applications, it is chosen for the supply rail. Extra supply voltage creates headroom that allows the LM4912 to reproduce peak in excess of 25mW without producing audible distortion. At this time, the designer must make sure that the power supply choice along with the output impedance does not violate the conditions explained in the **Power Dissipation** section.

Once the power dissipation equations have been addressed, the required gain can be determined from Equation 2.

$$A_V \geq \sqrt{(P_O R_L) / (V_{IN})} = V_{Orms} / V_{Inrms} \quad (3)$$

From Equation 4, the minimum  $A_V$  is 0.89; use  $A_V = 1$ . Since the desired input impedance is  $20k\Omega$ , and with a  $A_V$  gain of 1, a ratio of 1:1 results from Equation 1 for  $R_f$  to  $R_i$ . The values are chosen with  $R_i = 20k\Omega$  and  $R_f = 20k\Omega$ . The final design step is to address the bandwidth requirements which must be stated as a pair of -3dB frequency points. Five times away from a -3dB point is 0.17dB down from passband response which is better than the required  $\pm 0.25$ dB specified.

$$f_L = 100\text{Hz}/5 = 20\text{Hz}$$

$$f_H = 20\text{kHz} * 5 = 100\text{kHz}$$

As stated in the **External Components** section,  $R_i$  in conjunction with  $C_i$  creates a

$$C_i \geq 1 / (2\pi * 20k\Omega * 20\text{Hz}) = 0.397\mu F; \text{ use } 0.39\mu F.$$

The high frequency pole is determined by the product of the desired frequency pole,  $f_H$ , and the differential gain,  $A_V$ . With an  $A_V = 1$  and  $f_H = 100\text{kHz}$ , the resulting GBWP =  $100\text{kHz}$  which is much smaller than the LM4912 GBWP of  $10\text{MHz}$ . This figure displays that a designer has a need to design an amplifier with higher differential gain, the LM4912 can still be used without running into bandwidth limitations.

**Physical Dimensions** inches (millimeters) unless otherwise noted

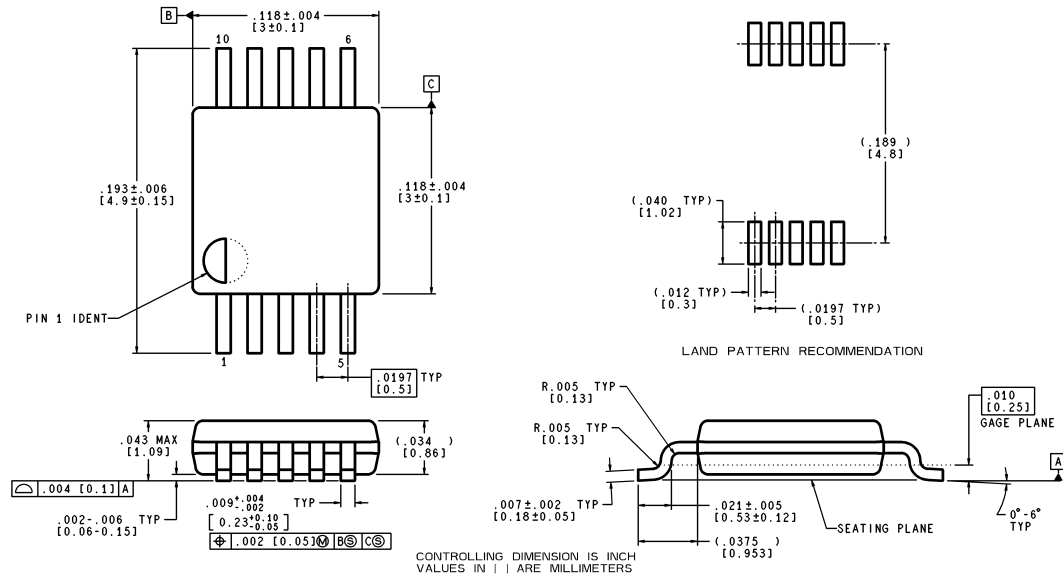

MUB10A (Rev A)

**MSOP**  
**Order Number LM4912MM**  
**NS Package Number MUB10A**

**LIFE SUPPORT POLICY**

NATIONAL'S PRODUCTS ARE NOT AUTHORIZED FOR USE AS CRITICAL COMPONENTS IN LIFE SUPPORT DEVICES OR SYSTEMS WITHOUT THE EXPRESS WRITTEN APPROVAL OF THE PRESIDENT AND GENERAL COUNSEL OF NATIONAL SEMICONDUCTOR CORPORATION. As used herein:

1. Life support devices or systems are devices or systems which, (a) are intended for surgical implant into the body, or (b) support or sustain life, and whose failure to perform when properly used in accordance with instructions for use provided in the labeling, can be reasonably expected to result in a significant injury to the user.
2. A critical component is any component of a life support device or system whose failure to perform can be reasonably expected to cause the failure of the life support device or system, or to affect its safety or effectiveness.



**National Semiconductor**  
**Americas Customer**  
**Support Center**  
 Email: new.feedback@nsc.com  
 Tel: 1-800-272-9959

**National Semiconductor**  
**Europe Customer Support Center**  
 Fax: +49 (0) 180-530 85 86  
 Email: europe.support@nsc.com  
 Deutsch Tel: +49 (0) 69 9508 6208  
 English Tel: +44 (0) 870 24 0 2171  
 Français Tel: +33 (0) 1 41 91 8790

**National Semiconductor**  
**Asia Pacific Customer**  
**Support Center**  
 Email: ap.support@nsc.com

**National Semiconductor**  
**Japan Customer Support Center**  
 Fax: 81-3-5639-7507  
 Email: jpn.feedback@nsc.com  
 Tel: 81-3-5639-7560

www.national.com