

DESCRIPTION

The LX5219 SCSI terminator is part of Linfinity's UltraMAX family of high-performance, adaptive, non-linear mode SCSI products, which are designed to deliver true UltraSCSI performance in SCSI applications. The low voltage BiCMOS architecture employed in its design offers superior performance to older linear passive and active techniques. Linfinity's UltraMAX architecture employs high-speed adaptive elements for each channel, thereby providing the fastest response possible — typically 35MHz, which is 100 times faster than the older linear regulator/terminator approach used by other manufacturers. Products using this older linear regulator approach have bandwidths which are dominated by the output capacitor and which are limited to 500KHz (see further discussion in the Functional Description section). The UltraMAX architecture also eliminates the output compensation capacitor typical in earlier terminator designs. It is approved for use with SCSI-1, -2, -3, UltraSCSI and beyond — providing the highest performance alternative available today.

Another key improvement offered by the LX5219 lies in its ability to insure reliable, error free communications even in systems which do not adhere to recommended SCSI hardware design guidelines, such as the use of improper cable lengths and impedances. Frequently, this situation is not con-

trolled by the peripheral or host designer and, when problems occur, they are the first to be made aware of the problem. The LX5219 architecture is much more tolerant of marginal system integrations.

Recognizing the needs of portable and configurable peripherals, the LX5219 has an active low TTL compatible sleep/disable mode. Quiescent current is typically less than (275µA) in this mode, while the output capacitance is also less than 3pF. The obvious advantage of extended battery life for portable systems is inherent in the product's sleep-mode feature. Additionally, the disable function permits factory-floor or production-line configurability, reducing inventory and product-line diversity costs. Field configurability can also be accomplished without physically removing components which, often times results in field returns due to mishandling.

Reduced component counts is also inherent in the LX5219 architecture. Traditional termination techniques require large stabilization and transient protection capacitors of up to 20µF in value and size. The LX5219 architecture does not require these components, allowing all the cost savings associated with inventory, board space, assembly, reliability, and component costs.

KEY FEATURES

- ULTRA-FAST RESPONSE FOR FAST-20 SCSI APPLICATIONS
- HOT SWAP COMPATIBLE
- 35MHZ CHANNEL BANDWIDTH
- 3.5V OPERATION
- LESS THAN 3pF OUTPUT CAPACITANCE
- SLEEP-MODE CURRENT LESS THAN 275µA
- THERMALLY SELF LIMITING
- NO EXTERNAL COMPENSATION CAPACITORS
- IMPLEMENTS 8-BIT OR 16-BIT (WIDE) APPLICATIONS
- COMPATIBLE WITH ACTIVE NEGATION DRIVERS (60mA / CHANNEL)
- COMPATIBLE WITH PASSIVE AND ACTIVE TERMINATIONS
- APPROVED FOR USE WITH SCSI 1, 2, 3 AND ULTRASCSI
- CONSULT FACTORY FOR APPLICATION TEST REPORT
- EVALUATION BOARD AVAILABLE

IMPORTANT: For the most current data, consult Linfinity's web site: <http://www.linfinity.com>.

PRODUCT HIGHLIGHT

RECEIVING WAVEFORM - 20MHZ

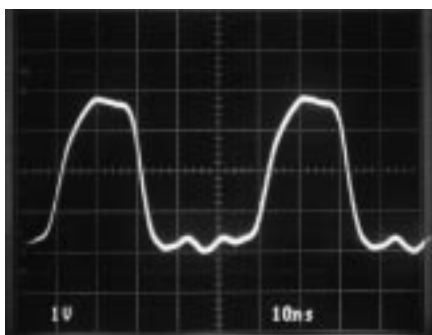

DRIVING WAVEFORM - 20MHZ

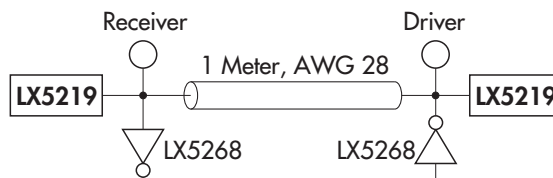
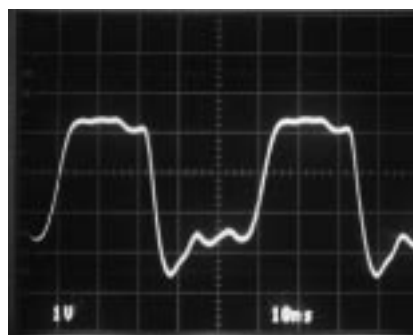

NOTE:
For An In-Depth Discussion On Applying SCSI, Request Linfinity Application Note: "Understanding The Single-Ended SCSI Bus"

PACKAGE ORDER INFORMATION

T _j (°C)	DW Plastic SOWB 16-pin	PW Plastic TSSOP 20-pin
0 to 70	LX5219CDW	LX5219CPW

Note: All surface-mount packages are available in Tape & Reel. Append the letter "T" to part number. (i.e. LX5219CDWT)

ULTRA 9-CHANNEL SCSI TERMINATOR

PRODUCTION DATA SHEET

ABSOLUTE MAXIMUM RATINGS (Note 1)

Continuous Termination Voltage	10V
Continuous Output Voltage Range	0 to 5.5V
Continuous Disable Voltage Range	0 to 5.5V
Operating Junction Temperature	0°C to 125°C
Storage Temperature Range	-65°C to +150°C
Solder Temperature (Soldering, 10 seconds)	300°C

Note 1. Exceeding these ratings could cause damage to the device.

THERMAL DATA

DW PACKAGE:

THERMAL RESISTANCE-JUNCTION TO AMBIENT, θ_{JA}	95°C/W
---	---------------

PW PACKAGE:

THERMAL RESISTANCE-JUNCTION TO AMBIENT, θ_{JA}	144°C/W
---	----------------

Junction Temperature Calculation: $T_J = T_A + (P_D \times \theta_{JA})$.
 The θ_{JA} numbers are guidelines for the thermal performance of the device/pc-board system.
 All of the above assume no ambient airflow.

PACKAGE PIN OUTS

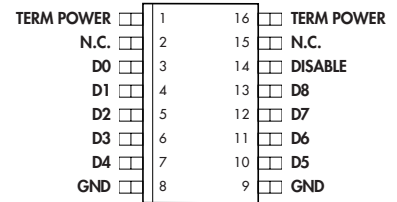

DW PACKAGE
(Top View)

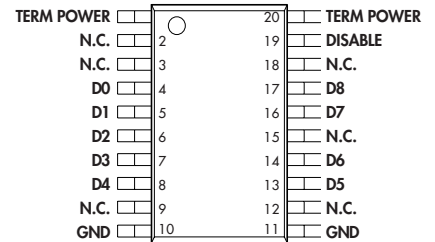

PW PACKAGE
(Top View)

ULTRA 9-CHANNEL SCSI TERMINATOR

PRODUCTION DATA SHEET

RECOMMENDED OPERATING CONDITIONS (Note 2)

Parameter	Symbol	Recommended Operating Conditions			Units
		Min.	Typ.	Max.	
Termination Voltage	V_{TERM}	3.5		5.5	V
High Level Disable Input Voltage	V_{RH}	2		V_{TERM}	V
Low Level Disable Input Voltage	V_{RL}	0		0.8	V
Operating Virtual Junction Temperature Range					
LX5219C		0		125	°C

Note 2. Range over which the device is functional.

ELECTRICAL CHARACTERISTICS

Term Power = 4.75V unless otherwise specified. Unless otherwise specified, these specifications apply at the recommended operating ambient temperature of $T_A = 25^\circ\text{C}$. Low duty cycle pulse testing techniques are used which maintains junction and case temperatures equal to the ambient temperature.

Parameter	Symbol	Test Conditions	LX5219			Units
			Min.	Typ.	Max.	
Output High Voltage	V_{OUT}		2.65	2.85		V
TermPwr Supply Current	I_{CC}	All data lines = open		6	9	mA
		All data lines = 0.5V		215	225	mA
		Disable Pin < 0.8V		375		μA
Output Current	I_{OUT}	$V_{OUT} = 0.5\text{V}$	-21	-23	-24	mA
Disable Input Current		Disable Pin = 4.75V		10		nA
		Disable Pin = 0V		-90		μA
Output Leakage Current		Disable Pin = < 0.8V, $V_O = 0.5\text{V}$		10		nA
Capacitance in Disabled Mode	C_{OUT}	$V_{OUT} = 0\text{V}$, frequency = 1MHz		3		pF
Channel Bandwidth	BW			35		MHz
Termination Sink Current, per Channel	I_{SINK}	$V_{OUT} = 4\text{V}$		60		mA

ULTRA 9-CHANNEL SCSI TERMINATOR

PRODUCTION DATA SHEET

BLOCK DIAGRAM

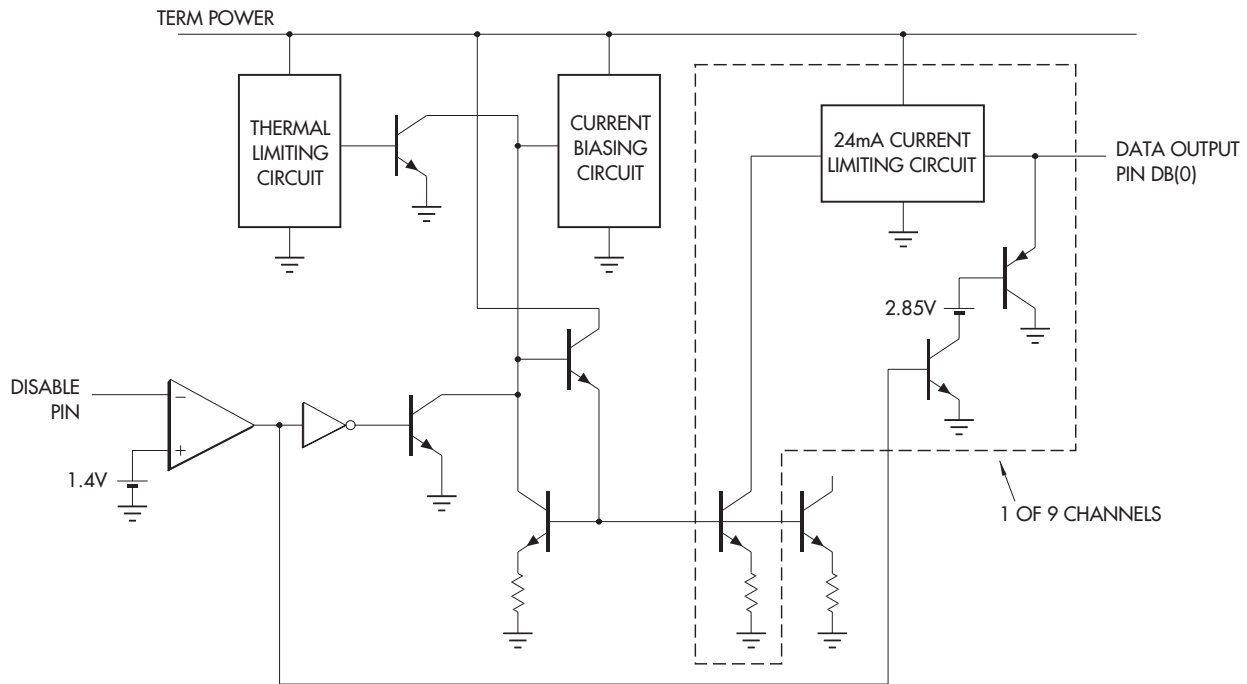

FUNCTIONAL DESCRIPTION

Cable transmission theory suggests to optimize signal speed and quality, the termination should act both as an ideal voltage reference when the line is released (deasserted) and as an ideal current source when the line is active (asserted). Common active terminators, which consist of Linear Regulators in series with resistors (typically 110Ω), are a compromise. As the line voltage increases, the amount of current decreases linearly by the equation $V = I * R$. The LX5219, with its unique new architecture applies the maximum amount of current regardless of line voltage until the termination high threshold (2.85V) is reached.

Acting as a near ideal line terminator, the LX5219 closely reproduces the optimum case when the device is enabled. To enable the device the Disable Pin must be pulled logic **High** or left **Open**. During this mode of operation, quiescent current is 6mA and the device will respond to line demands

by delivering 24mA on assertion and by imposing 2.85V on deassertion. In order to disable the device, the Disable pin must be driven logic **Low**. This mode of operation places the device in a sleep state where a meager 275µA of quiescent current is consumed. Additionally, all outputs are in a Hi-Z (impedance) state. Sleep mode can be used for power conservation or to completely eliminate the terminator from the SCSI chain. In the second case, termination node capacitance is important to consider. The terminator will appear as a parasitic distributed capacitance on the line, which can detract from bus performance. For this reason, the

POWER UP / POWER DOWN FUNCTION TABLE

Disable (LX5219)	Outputs	Quiescent Current
H	Enabled	6mA
L	HI Z	275µA
Open	Enabled	6mA

LX5219 has been optimized to have only 3pF of capacitance per output in the sleep state.

An additional feature of the LX5219 is its compatibility with active negation drivers. The device handles up to 60mA of sink current for drivers which exceed the 2.85V output high.

ULTRA 9-CHANNEL SCSI TERMINATOR

PRODUCTION DATA SHEET

GRAPH / CURVE INDEX

Waveforms

FIGURE

- 1A. RECEIVING WAVEFORM (Freq. = 1.0MHz)
- 1B. DRIVING WAVEFORM
- 2A. RECEIVING WAVEFORM (Freq. = 5.0MHz)
- 2B. DRIVING WAVEFORM
- 3. 10MHz WAVEFORM
- 4. 20MHz WAVEFORM

Characteristic Curves

FIGURE

- 5. OUTPUT HIGH VOLTAGE vs. JUNCTION TEMPERATURE
- 6. OUTPUT CURRENT vs. JUNCTION TEMPERATURE
- 7. OUTPUT CURRENT vs. OUTPUT HIGH VOLTAGE ($V_T = 4.75V$)
- 8. OUTPUT CURRENT vs. OUTPUT HIGH VOLTAGE ($V_T = 3.3V$)
- 9. TERMINATION VOLTAGE vs. SUPPLY CURRENT
- 10. TERMPWR SUPPLY CURRENT vs. TERMINATION VOLTAGE (Disabled)
— LX5219
- 11. OUTPUT HIGH VOLTAGE vs. JUNCTION TEMPERATURE ($V_T = 3.3V$)
- 12. OUTPUT CURRENT vs. JUNCTION TEMPERATURE ($V_T = 3.3V$)
- 13. OUTPUT HIGH VOLTAGE vs. TERMINATION VOLTAGE
- 14. OUTPUT CURRENT vs. TERMINATION VOLTAGE
- 15. OUTPUT CURRENT MATCHING CHANNEL TO CHANNEL

FIGURE INDEX

Application Circuits

FIGURE

- 16. 8-BIT SCSI SYSTEM APPLICATION

ULTRA 9-CHANNEL SCSI TERMINATOR

PRODUCTION DATA SHEET

CHARACTERISTIC CURVES

FIGURE 1A. — RECEIVING WAVEFORM

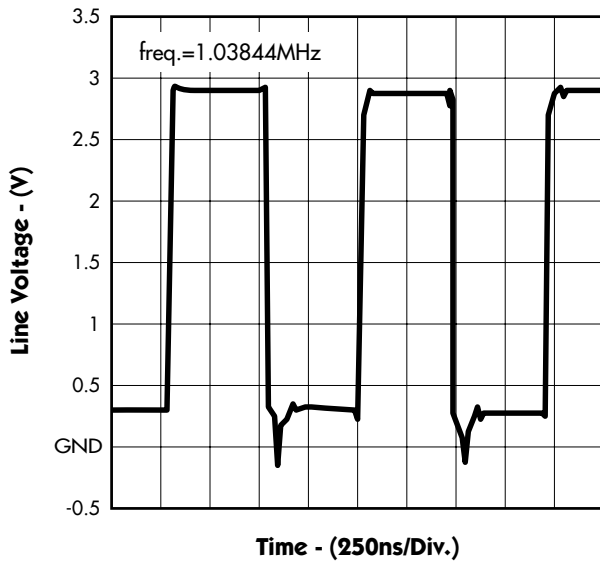
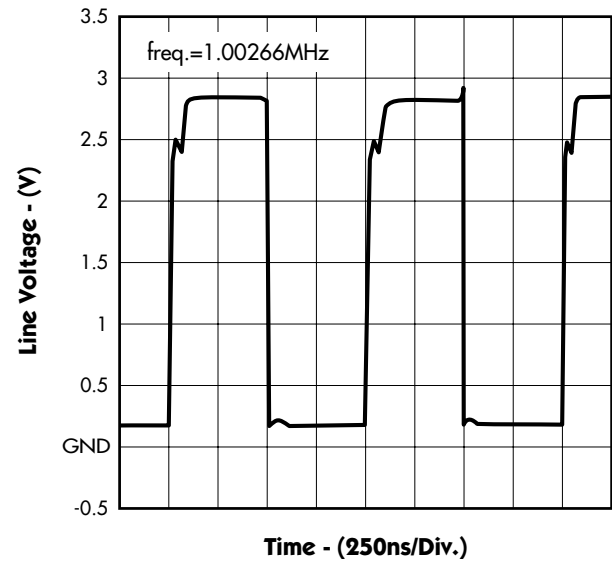
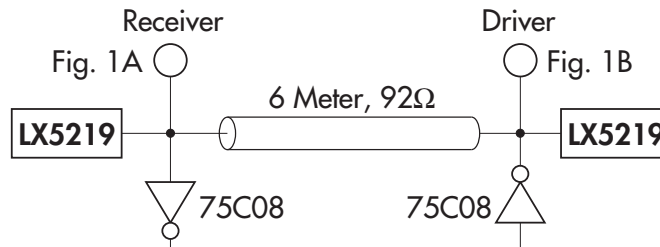

FIGURE 1B. — DRIVING WAVEFORM



END-DRIVEN CABLE



ULTRA 9-CHANNEL SCSI TERMINATOR

PRODUCTION DATA SHEET

CHARACTERISTIC CURVES

FIGURE 2A. — RECEIVING WAVEFORM

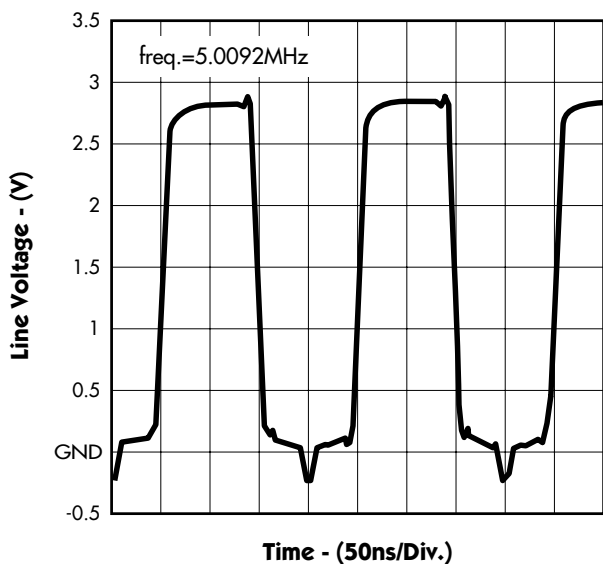
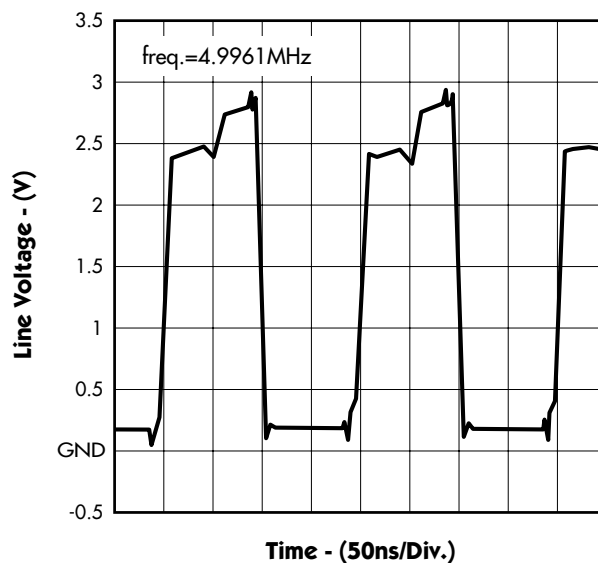
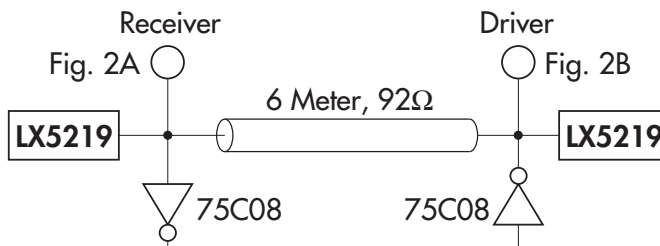

FIGURE 2B. — DRIVING WAVEFORM



END-DRIVEN CABLE



ULTRA 9-CHANNEL SCSI TERMINATOR

PRODUCTION DATA SHEET

CHARACTERISTIC CURVES

FIGURE 3. — 10MHz WAVEFORM

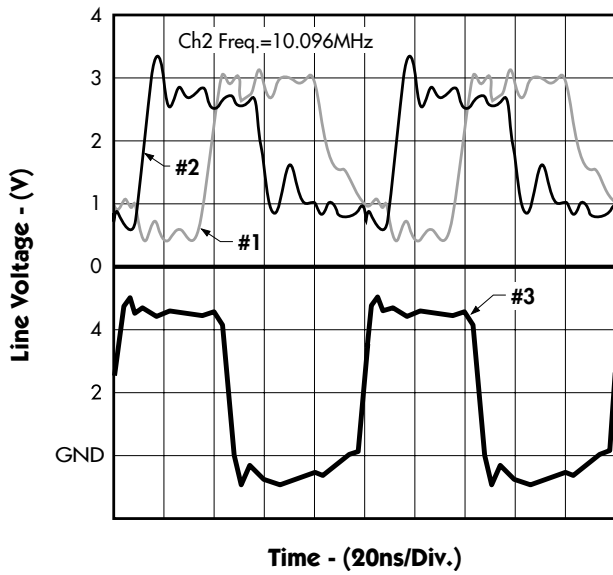
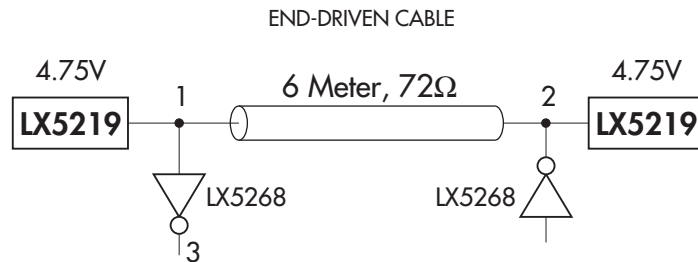
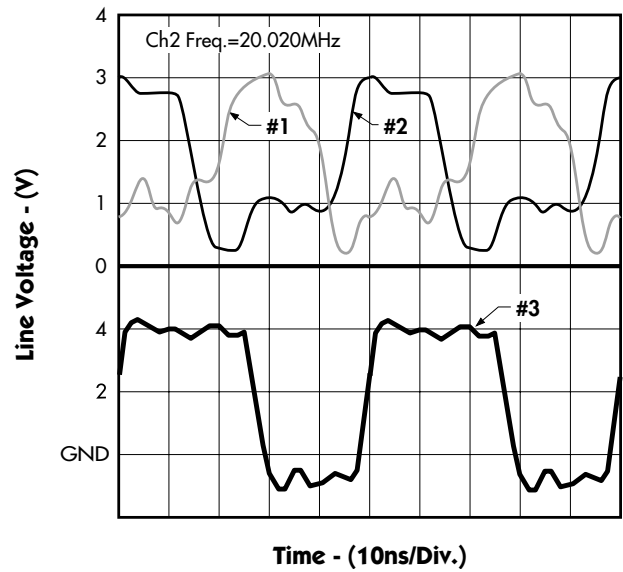

FIGURE 4. — 20MHz WAVEFORM



ULTRA 9-CHANNEL SCSI TERMINATOR

PRODUCTION DATA SHEET

CHARACTERISTIC CURVES

FIGURE 5. — OUTPUT HIGH VOLTAGE vs. JUNCTION TEMP.

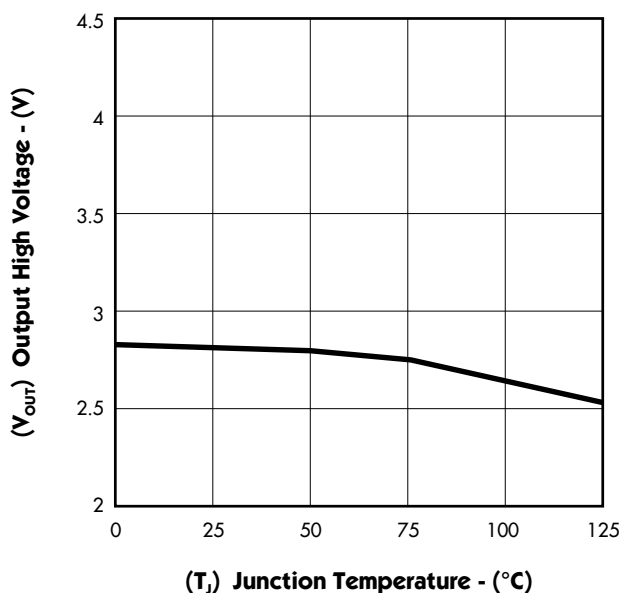

FIGURE 6. — OUTPUT CURRENT vs. JUNCTION TEMP.

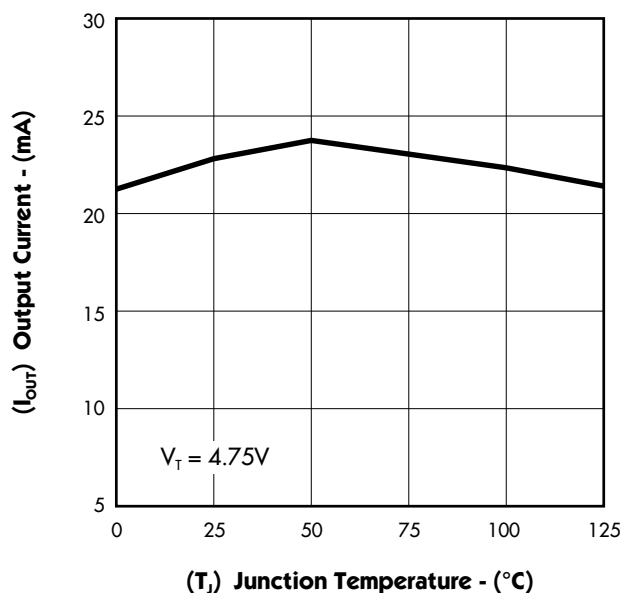

FIGURE 7. — OUTPUT CURRENT vs. OUTPUT HIGH VOLTAGE

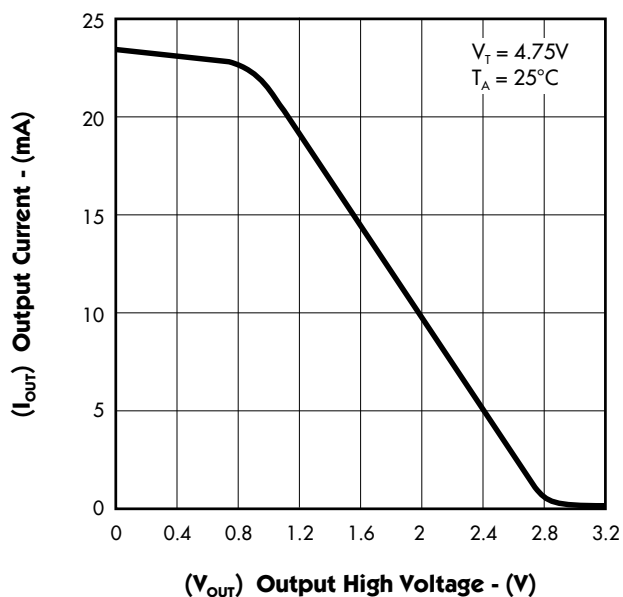
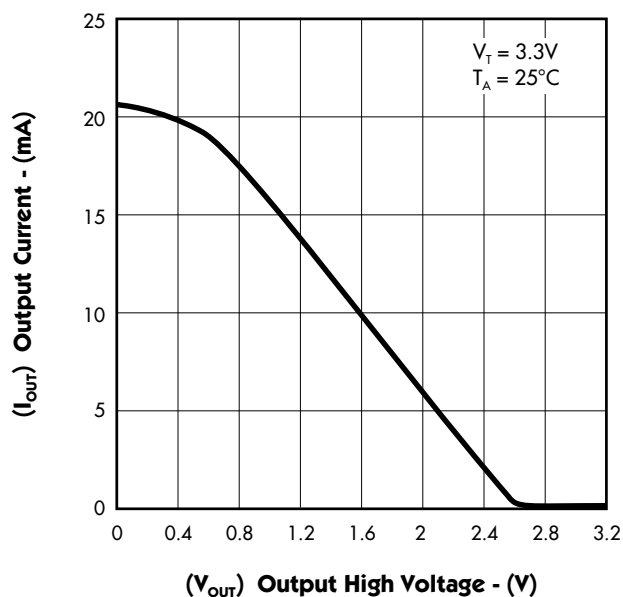

FIGURE 8. — OUTPUT CURRENT vs. OUTPUT HIGH VOLTAGE



ULTRA 9-CHANNEL SCSI TERMINATOR

PRODUCTION DATA SHEET

CHARACTERISTIC CURVES

FIGURE 9. — TERMPWR SUPPLY CURRENT vs. TERMINATION VOLTAGE

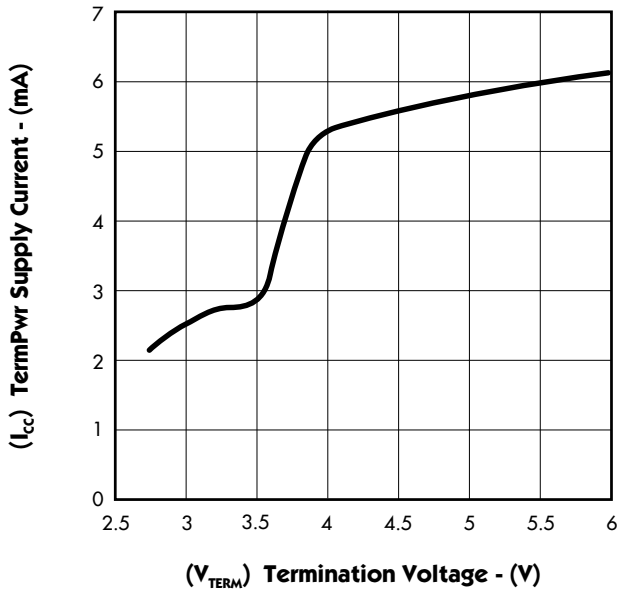

FIGURE 10. — LX5219 TERMPWR SUPPLY CURRENT vs. TERMINATION VOLTAGE (Disabled)

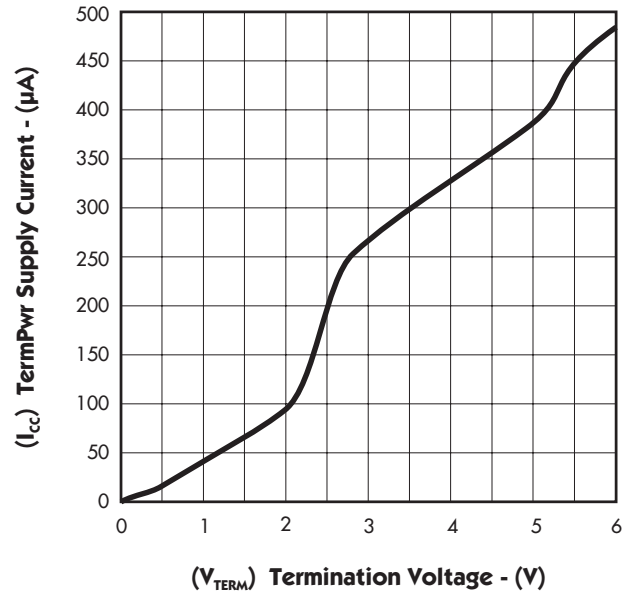

FIGURE 11. — OUTPUT HIGH VOLTAGE vs. JUNCTION TEMP.

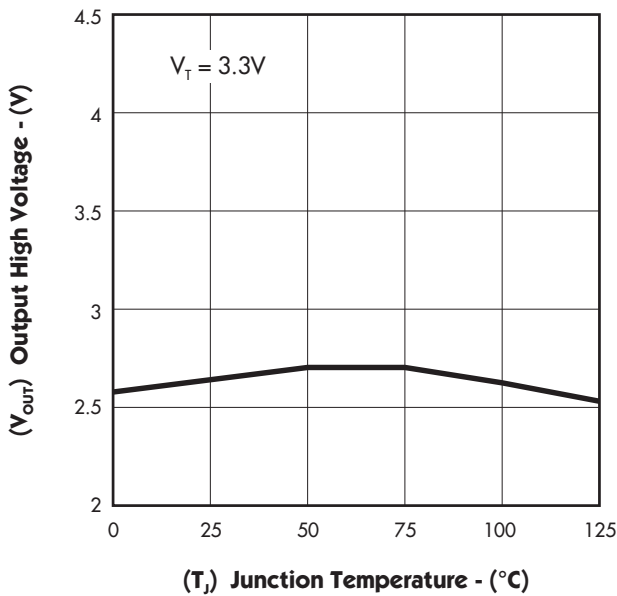
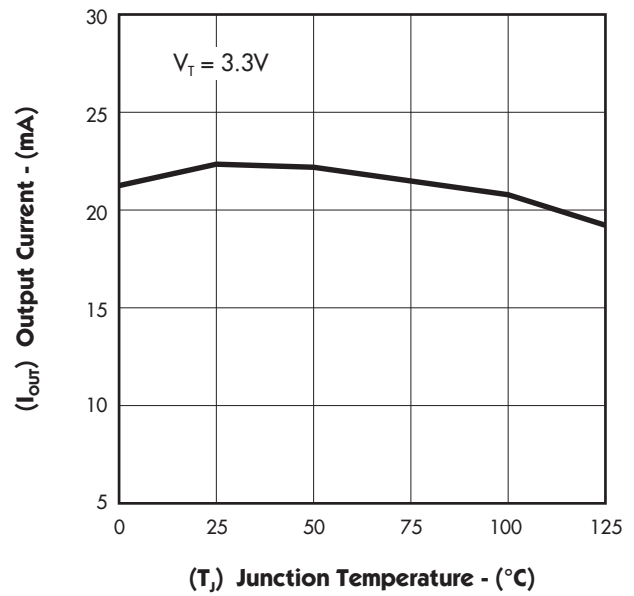

FIGURE 12. — OUTPUT CURRENT vs. JUNCTION TEMP.



ULTRA 9-CHANNEL SCSI TERMINATOR

PRODUCTION DATA SHEET

CHARACTERISTIC CURVES

FIGURE 13. — OUTPUT HIGH VOLTAGE vs. TERMINATION VOLTAGE

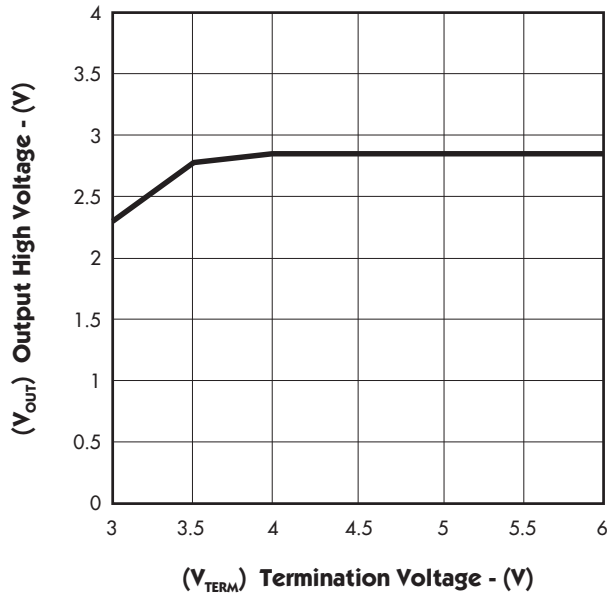
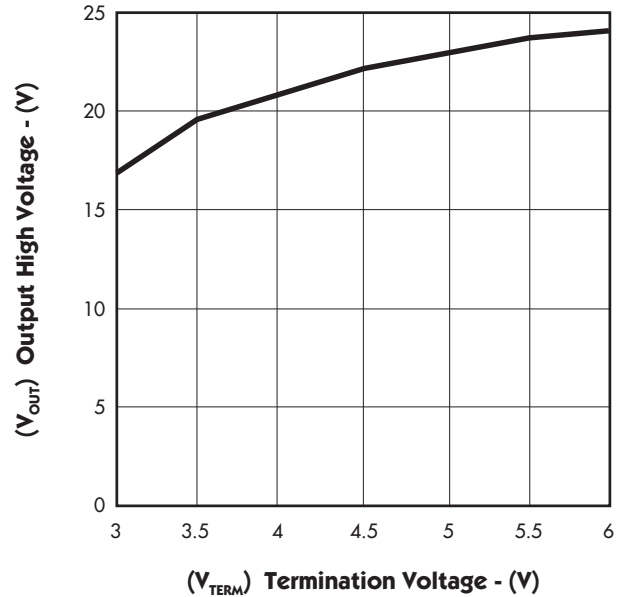

FIGURE 14. — OUTPUT CURRENT vs. TERMINATION VOLTAGE



ULTRA 9-CHANNEL SCSI TERMINATOR

PRODUCTION DATA SHEET

CHARACTERISTIC CURVES

FIGURE 15. — OUTPUT CURRENT CHANNEL TO CHANNEL MATCHING

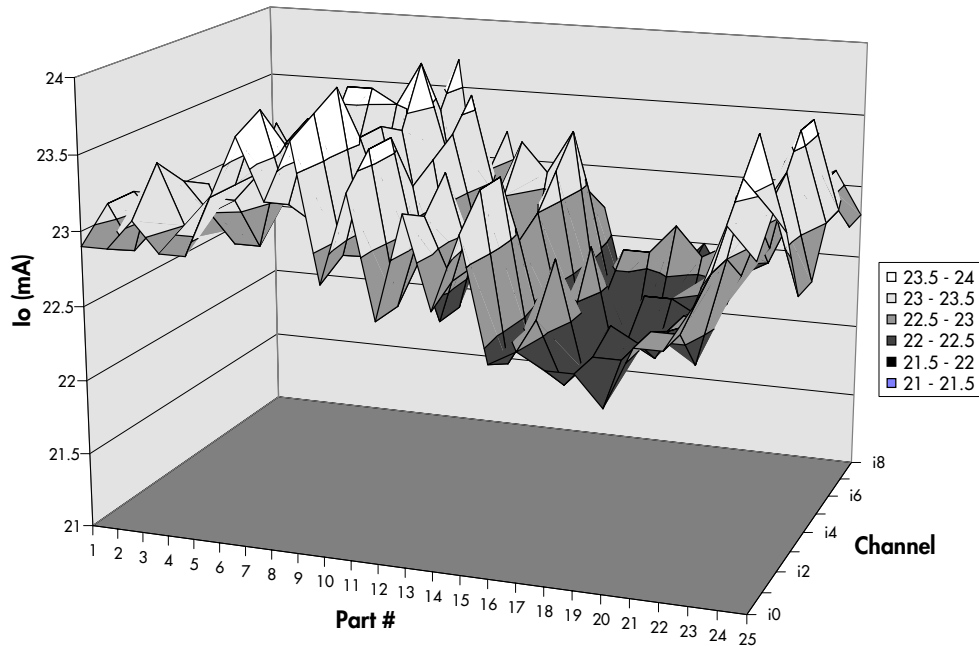

APPLICATION SCHEMATIC

FIGURE 16 — 8-BIT SCSI SYSTEM APPLICATION

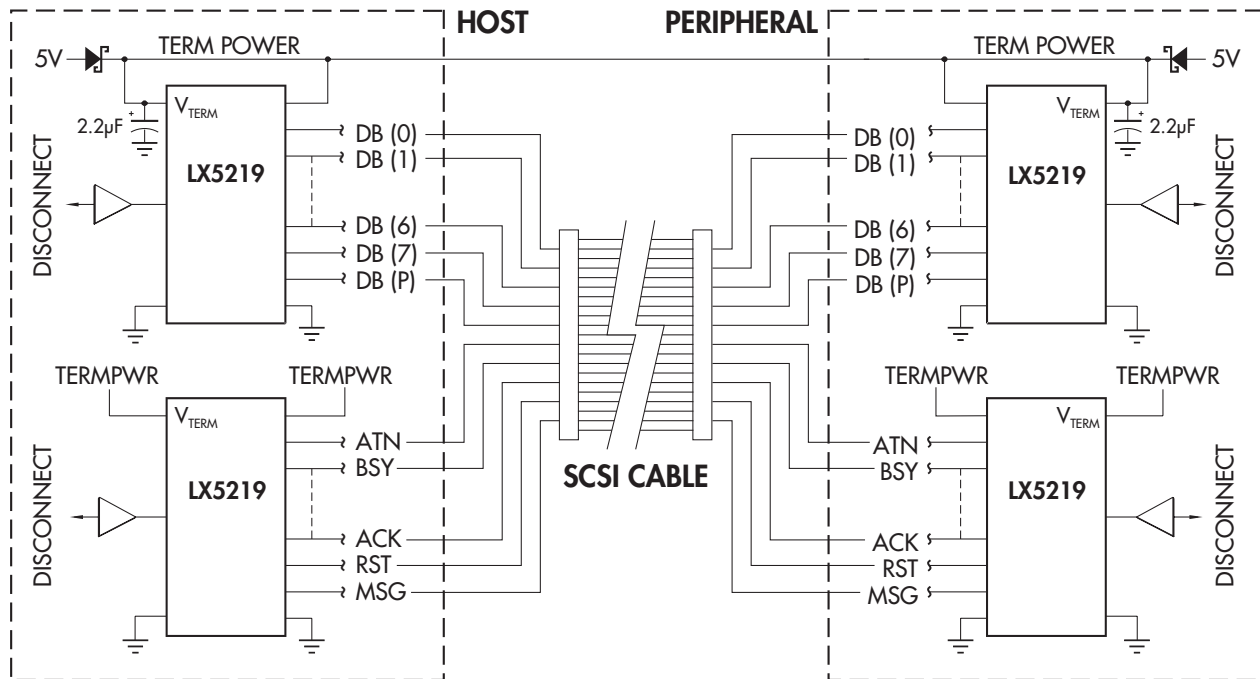

Note: Add third LX5219 for 16-bit SCSI

UltraMAX is a trademark of Linfinitly Microelectronics Inc.

PRODUCTION DATA - Information contained in this document is proprietary to Linfinitly, and is current as of publication date. This document may not be modified in any way without the express written consent of Linfinitly. Product processing does not necessarily include testing of all parameters. Linfinitly reserves the right to change the configuration and performance of the product and to discontinue product at any time.

