

## PRECISION TEMPERATURE-TO-VOLTAGE CONVERTERS

### FEATURES

- Linearized Temperature-to-Voltage Converters
- Direct Centigrade Output Voltage Scaling (TC03)
- Wide Temperature Measurement Range (TC02) ..... - 20°C to +125°C
- Excellent Temperature Converter Linearity .. 0.8°C Over Temperature
- High Temperature Converter Accuracy ..... ±2°C at 25°C Guaranteed
- Small Packages ..... TO-92-3 and SOT-23B-3

### APPLICATIONS

- Power Supply Thermal Shut-Down
- Temperature-Controlled Fans
- Temperature Measurement/Instrumentation
- Temperature Regulators
- Consumer Electronics

### GENERAL DESCRIPTION

The TC02/03 temperature sensors furnish a linearized output voltage directly proportional to measured temperature. The TC03 has a temperature measurement range of - 20°C to +100°C. Its output voltage is directly calibrated in degrees Centigrade (i.e.  $V_{OUT} = 10mV/^{\circ}C \times \text{Temperature } ^{\circ}C$ ). An external pull-down resistor to a negative voltage source is required for temperature measurement below 0°C.

The TC02 has a temperature measurement range of - 20°C to +125°C, and operates with a single supply. It has the same output voltage slope with temperature as the TC03 (10mV/°C). The output voltage range is 300mV at - 20°C to 1,750mV at +125°C.

Small size, low cost and low power operation make the TC02/03 suitable for a wide range of general purpose temperature measurement applications.

### ORDERING INFORMATION

Part No.	Package	Output Voltage At 25°C	Temp. Range
TC02VNB	*SOT-23B-3	750mV	- 20°C to +125°C
TC02VZB	TO-92	750mV	- 20°C to +125°C
TC03VNB	*SOT-23B-3	250mV	- 20°C to +100°C
TC03VZB	TO-92	250mV	- 20°C to +100°C

**NOTE:** \*SOT-23B-3 is equivalent to JEDEC (TO-236)

### FUNCTIONAL BLOCK DIAGRAM

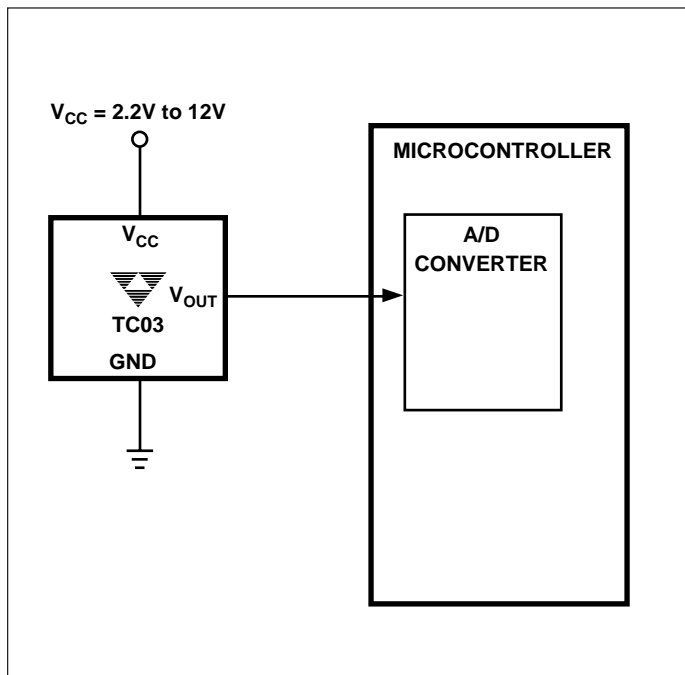

### PIN CONFIGURATION

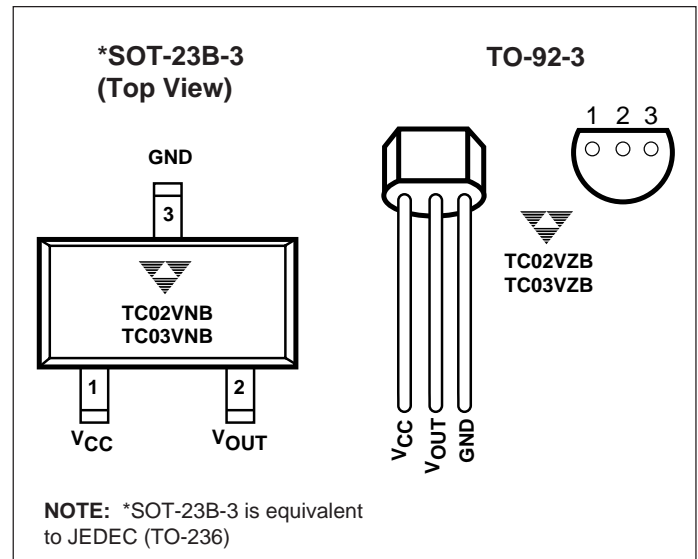

TC02  
TC03

**ABSOLUTE MAXIMUM RATINGS \***

Supply Voltage .....	15V
Input Voltage, Any Terminal .....	- 1.0 to (V <sub>CC</sub> +0.3V)
Operating Temperature (TC02) .....	- 20°C to +125°C
Operating Temperature (TC03) .....	- 20°C to +100°C
Storage Temperature .....	- 55°C to +150°C
Lead Temperature (Soldering, 10 sec)	
SOT-23B-3 .....	+260°C
TO-92-3 .....	+300°C

\* Static-sensitive device. Unused devices must be stored in conductive material. Protect devices from static discharge and static fields. Stresses above those listed under Absolute Maximum Ratings may cause permanent damage to the device. These are stress ratings only and functional operation of the device at these or any other conditions above those indicated in the operational sections of the specifications is not implied. Exposure to Absolute Maximum Rating Conditions for extended periods may affect device reliability.

**ELECTRICAL CHARACTERISTICS :** T<sub>A</sub> = - 20°C to +125°C, V<sub>CC</sub> = 5V ±5%, unless otherwise specified.

Symbol	Parameter	Test Conditions	Min	Typ	Max	Unit
V <sub>CC</sub>	Supply Voltage (TC02)		3.0	—	12	V
V <sub>CC</sub>	Supply Voltage (TC03)		2.2	—	12	V
I <sub>S</sub>	Supply Current	Note 1	—	40	60	µA
I <sub>SRC</sub>	V <sub>OUT</sub> Output Source Current		—	—	1.0	mA
	Accuracy at Room Temperature	T <sub>A</sub> = 25°C (Note 2)	- 2	± 0.5	+2	°C
	Accuracy at Minimum Temperature	TC02: T <sub>A</sub> = - 20°C TC03: T <sub>A</sub> = - 20°C (Note 2)	- 7 - 7	± 0.5 ± 0.5	+5 +5	°C
	Accuracy at Maximum Temperature	TC02: T <sub>A</sub> = +125°C TC03: T <sub>A</sub> = +100°C (Note 2)	- 3 - 3	— —	+3 +3	°C
	Nonlinearity	Note 3, 4	- 0.8	—	+0.8	°C
	Line Regulation		—	80	—	µV/V
A <sub>V</sub>	Average Slope of Output Voltage		—	10	—	mV/°C
V <sub>OUTMAX</sub>	Maximum Output Voltage	TC02: 3.0V ≤ V <sub>CC</sub> ≤ 12V TC03: 2.2V ≤ V <sub>CC</sub> ≤ 12V (Note 1)	—	—	V <sub>CC</sub> - 1.2	V

- Notes:** 1. V<sub>OUT</sub> outputs open circuited.  
 2. Accuracy = Difference between calculated output voltage (10mV/°C x Device case temperature at specified temperature and power supply) and measured output voltage expressed in °C.  
 3. Nonlinearity = deviation of output voltage versus temperature from the best-fit straight line over the device rated temperature range.  
 4. Guaranteed by design.

**DETAILED DESCRIPTION**

A plot of output voltage versus temperature for both the TC02 and TC03 appears in Figure 1. The TC03 can be used with single power supply to measure temperatures from 0°C to 100°C. A pull-down resistor (R1 in Figure 2) must be added from V<sub>OUT</sub> to the negative power supply for measuring temperatures less than 0°C. The value of the resistor must be chosen to limit the maximum current pulled from the output to the negative supply to - 50µA (i.e. R1 = V<sub>SS</sub>/50µA).

**OUTPUT STAGE**

Both the TC02 and TC03 have Class A output stages capable of sourcing 1mA. These devices have a limited ability to drive heavy capacitive loads. Loads of 50pF (to ground) can be driven directly. For heavier loads, a 2kΩ (or greater) resistor should be placed in series with the output for decoupling. If the TC02/03 is used in a noisy electrical environment, a 0.1µF bypass capacitor from V<sub>CC</sub> to GND is recommended.

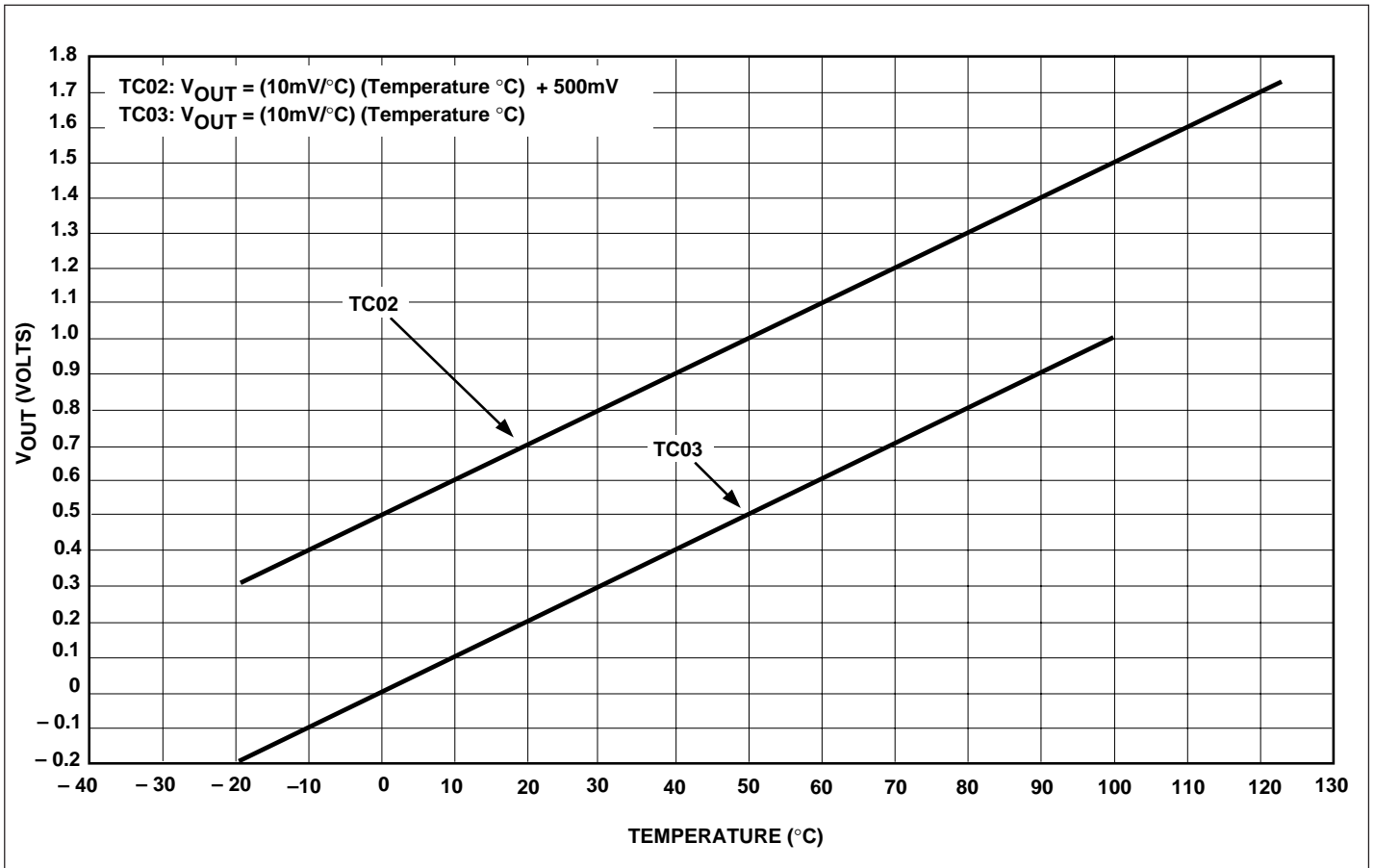

Figure 1. Output Voltage vs Temperature

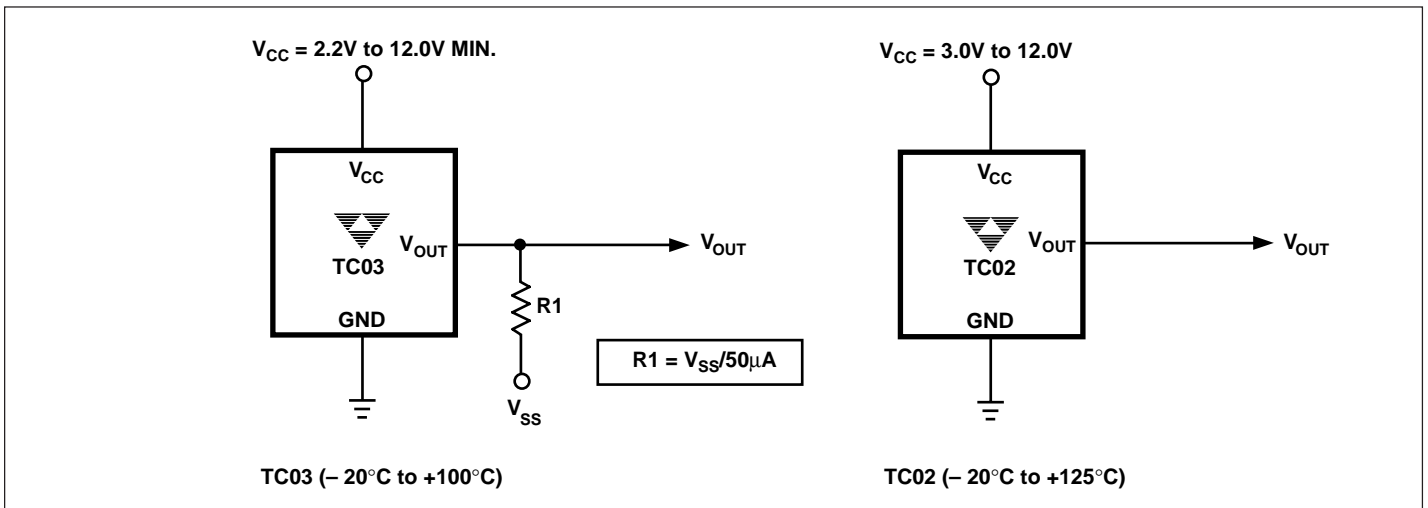
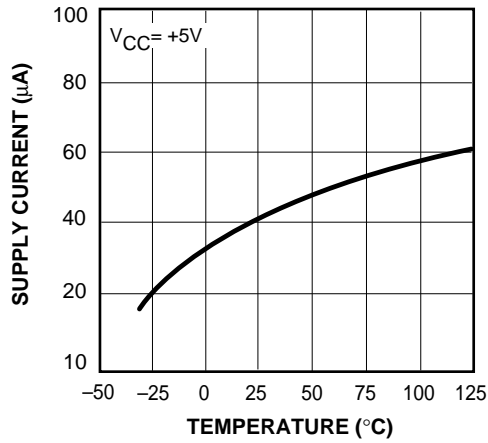

Figure 2. TC02/03 Power Supply Connections for Full Scale Measurements

TC02  
TC03

TYPICAL CHARACTERISTICS

Supply Current vs. Temperature



Thermal Time Constant (Sec) vs. Air Velocity

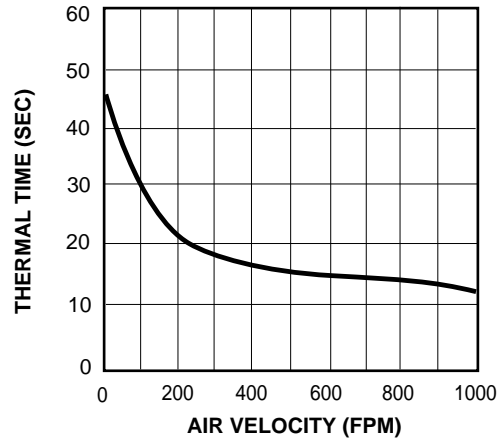

Thermal Response in Still Air vs. Time

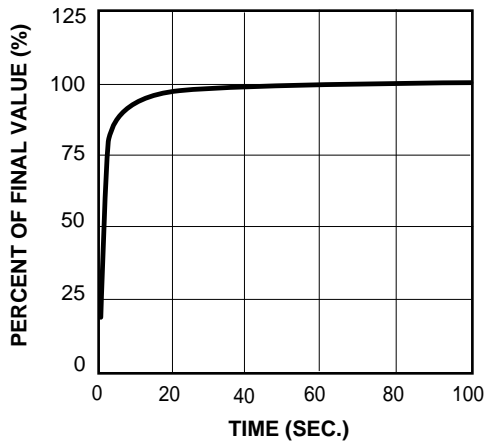

V<sub>OUT</sub> (From Power Initially Applied) vs. Time (Turn-on Response)

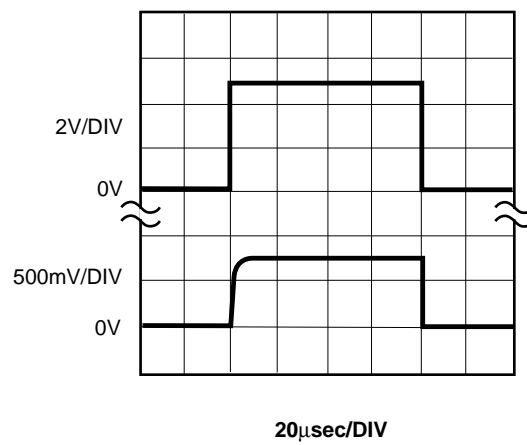

## MARKING

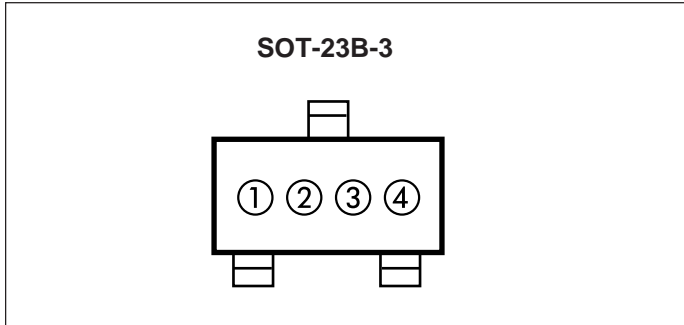

① & ② = part number code and temperature range  
 TC02VNB = AA - 20°C to 125°C  
 TC03VNB = AB - 20°C to 100°C

ex: 02 = (A)(A)( ) ( )  
 ex: 03 = (A)(B)( ) ( )

③ = year and quarter

④ = lot ID

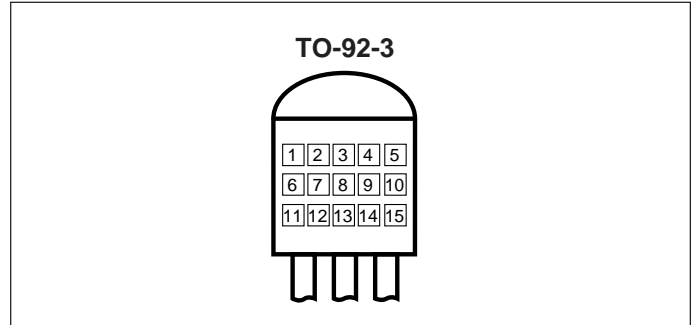

① & ② = TC (fixed)

③, ④ & ⑤ = blank

⑥, ⑦, ⑧ & ⑨ = part number

⑩ = temperature range  
 C = - 20°C to +125°C  
 D = - 20°C to +100°C

⑪, ⑫, ⑬, ⑭ & ⑮ = traceability code

## TAPING FORMS

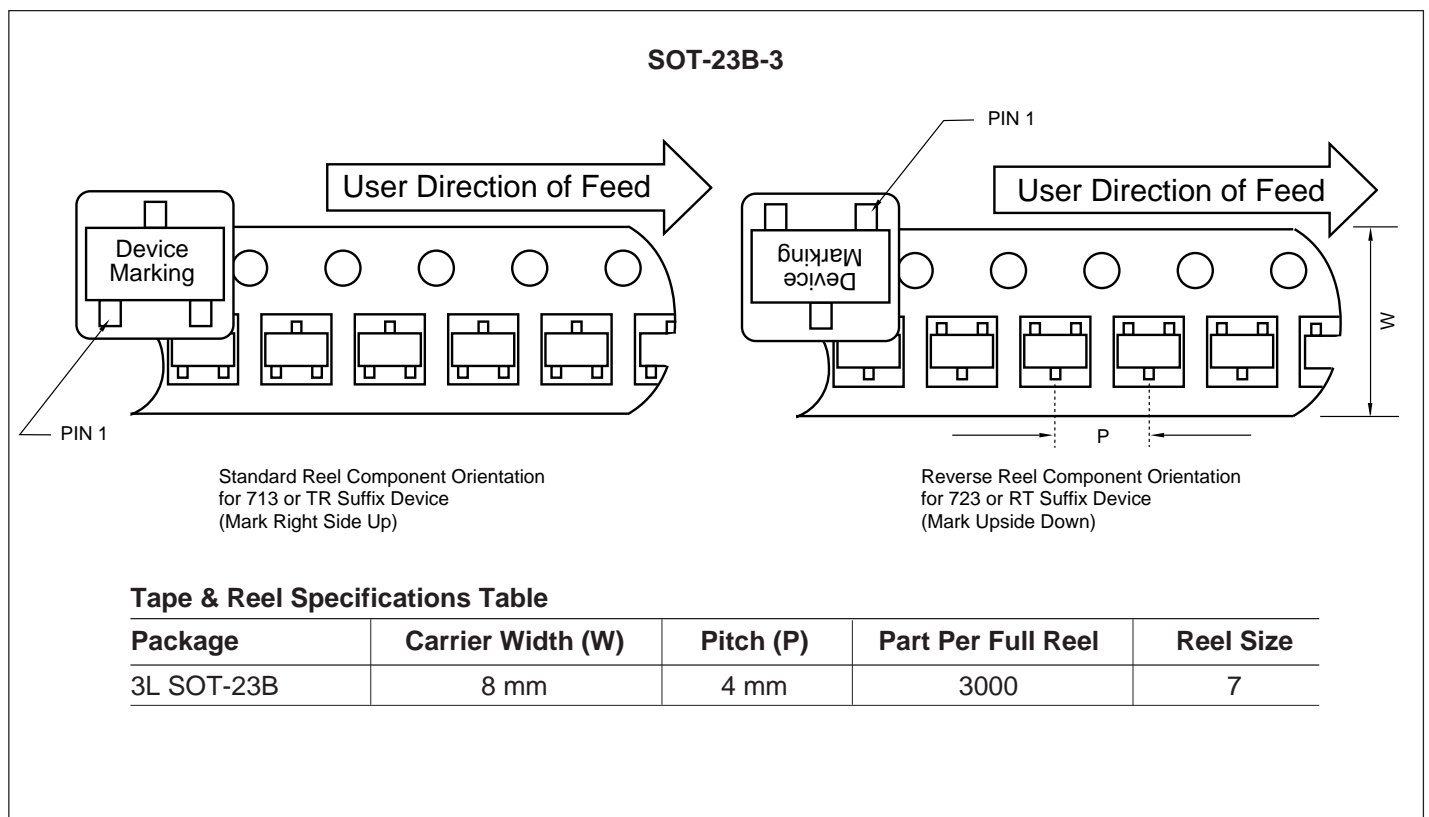

**Tape & Reel Specifications Table**

Package	Carrier Width (W)	Pitch (P)	Part Per Full Reel	Reel Size
3L SOT-23B	8 mm	4 mm	3000	7

TC02  
TC03

TAPING FORMS (Cont.)

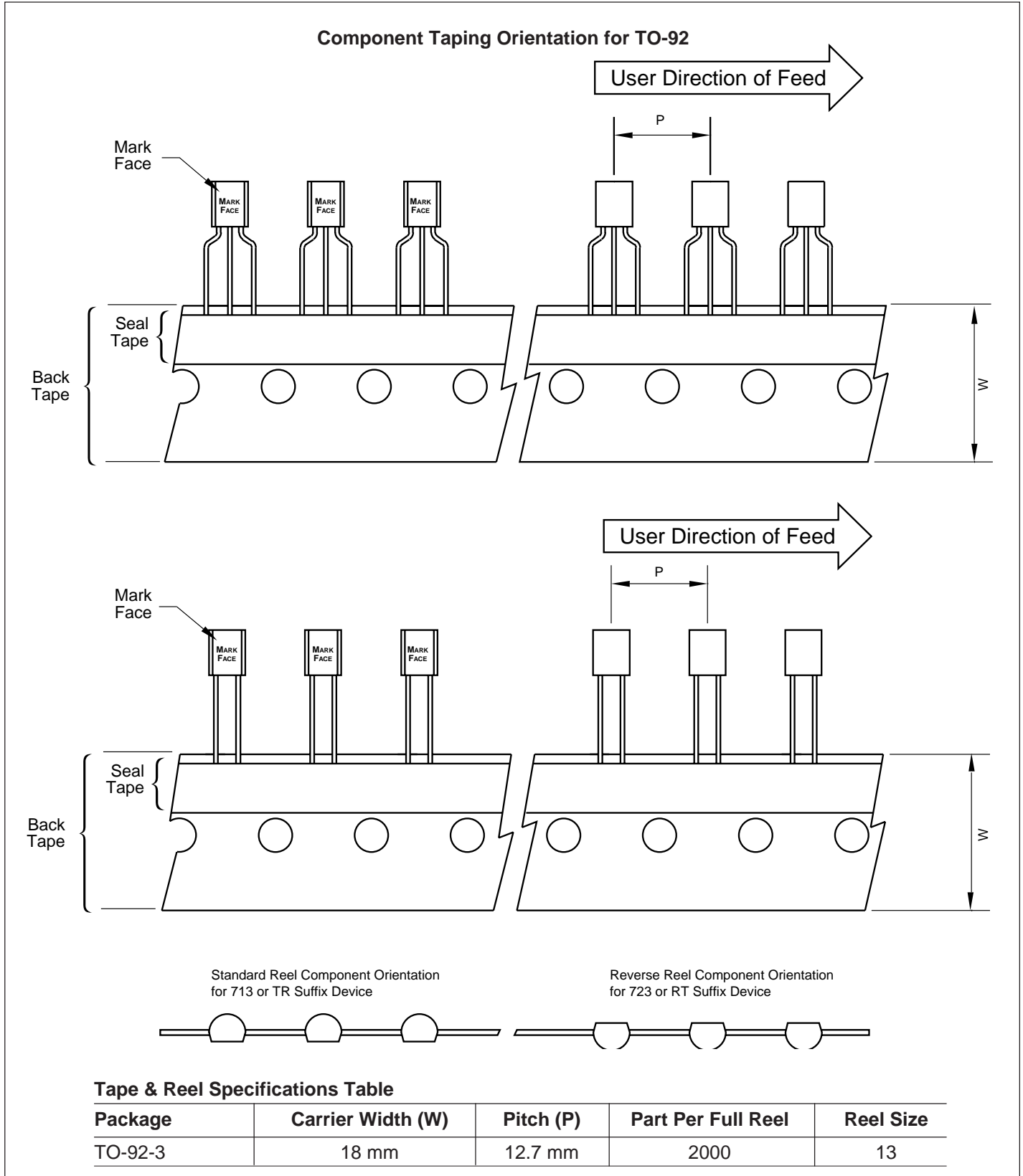

**PACKAGE DIMENSIONS**

**\*SOT-23B-3**

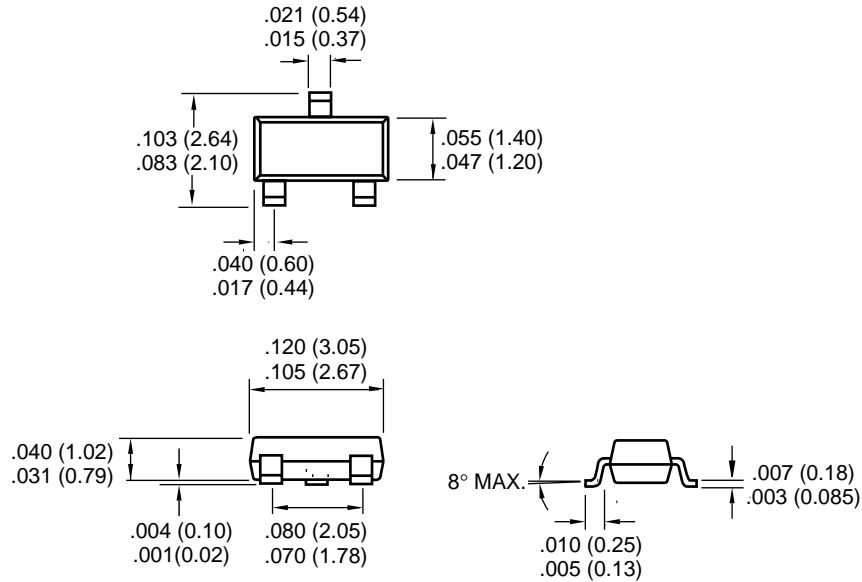

**\*NOTE:** SOT-23B-3 is equivalent to JEDEC (TO-236)

**TO-92-3**

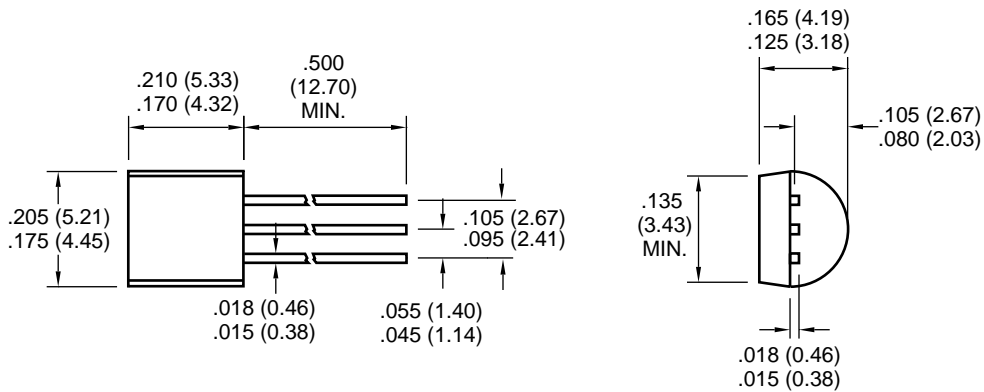

Dimensions: inches (mm)

**Sales Offices**

**TelCom Semiconductor**  
1300 Terra Bella Avenue  
P.O. Box 7267  
Mountain View, CA 94039-7267  
TEL: 415-968-9241  
FAX: 415-967-1590  
E-Mail: liter@c2smtp.telcom-semi.com

**TelCom Semiconductor**  
Austin Product Center  
9101 Burnet Rd. Suite 214  
Austin, TX 78758  
TEL: 512-873-7100  
FAX: 512-873-8236

**TelCom Semiconductor H.K. Ltd.**  
10 Sam Chuk Street, Ground Floor  
San Po Kong, Kowloon  
Hong Kong  
TEL: 852-2324-0122  
FAX: 852-2354-9957