

FEATURES

Low power operation

5 V operation:

- 1.0 mA per channel max @ 0–2 Mbps
- 3.5 mA per channel max @ 10 Mbps
- 31 mA per channel max @ 90 Mbps

3 V operation:

- 0.7 mA per channel max @ 0–2 Mbps
- 2.1 mA per channel max @ 10 Mbps
- 20 mA per channel max @ 90 Mbps

Bidirectional communication

3 V/5 V level translation

High temperature operation: 105°C

High data rate: DC–90 Mbps (NRZ)

Precise timing characteristics:

- 2 ns max. pulsewidth distortion
- 2 ns max. channel-to-channel matching

High common-mode transient immunity: > 25 kV/μs

Output enable function

Wide body SOIC 16-lead package

Safety and regulatory approvals (pending)

- UL recognition: 5000 V rms for 1 minute per UL 1577
- CSA component acceptance notice #5A
- VDE certificate of conformity
 - DIN EN 60747-5-2 (VDE 0884 Part 2): 2003-01
 - DIN EN 60950 (VDE 0805):2001-12;EN 60950:2000
 - V_{IORM} = 848 V peak
- IEC 60601-1

APPLICATIONS

General-purpose, high voltage, multichannel isolation

Medical Equipment

Motor Drives

Power Supplies

GENERAL DESCRIPTION

The ADuM240x are four-channel digital isolators based on Analog Devices' *iCoupler*® technology. Combining high speed CMOS and monolithic air core transformer technology, these isolation components provide outstanding performance characteristics superior to alternatives such as optocoupler devices. In comparison to the 2.5KV ADuM140x product family, ADuM240x models have increased insulation thickness to achieve the higher 5.0KV isolation rating.

By avoiding the use of LEDs and photodiodes, *iCoupler* devices remove the design difficulties commonly associated with optocouplers. The typical optocoupler concerns regarding uncertain current transfer ratios, nonlinear transfer functions, and temperature and lifetime effects are eliminated with the simple, *iCoupler* digital interfaces and stable performance characteristics. The need for external drivers and other discretes is eliminated with these *iCoupler* products. Furthermore, *iCoupler* devices run at one-tenth to one-sixth the power consumption of optocouplers at comparable signal data rates.

The ADuM240x isolators provide four independent isolation channels in a variety of channel configurations and data rates (see Ordering Guide). All ADuM240x models operate with the supply voltage of either side ranging from 2.7 V to 5.5 V, providing compatibility with lower voltage systems as well as enabling a voltage translation functionality across the isolation barrier. In addition, the ADuM240x provides low pulse width distortion (<2 ns for CRWZ grade), and tight channel-to-channel matching (<2 ns for CRWZ grade). Unlike other optocoupler alternatives, the ADuM240x isolators have a patented refresh feature that ensures dc correctness in the absence of input logic transitions and during power-up/power-down conditions.

FUNCTIONAL BLOCK DIAGRAMS

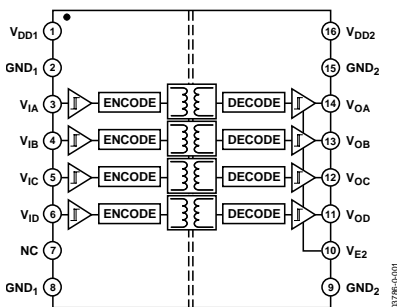

Figure 1. ADuM2400 Functional Block Diagram

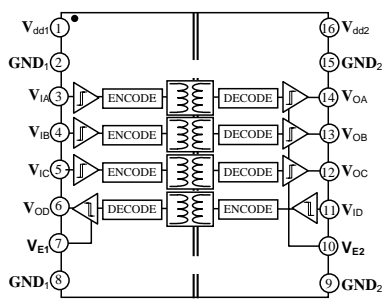

Figure 2. ADuM2401 Functional Block Diagram

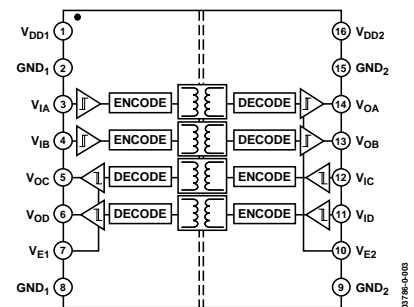

Figure 3. ADuM2402 Functional Block Diagram

Rev. PrD October 5, 2004

Information furnished by Analog Devices is believed to be accurate and reliable. However, no responsibility is assumed by Analog Devices for its use, nor for any infringements of patents or other rights of third parties that may result from its use. Specifications subject to change without notice. No license is granted by implication or otherwise under any patent or patent rights of Analog Devices. Trademarks and registered trademarks are the property of their respective owners.

One Technology Way, P.O. Box 9106, Norwood, MA 02062-9106, U.S.A.
 Tel: 781.329.4700 www.analog.com
 Fax: 781.326.8703 © 2004 Analog Devices, Inc. All rights reserved.

ELECTRICAL CHARACTERISTICS—5 V OPERATION¹

4.5 V ≤ V_{DD1} ≤ 5.5 V, 4.5 V ≤ V_{DD2} ≤ 5.5 V. All min/max specifications apply over the entire recommended operation range, unless otherwise noted. All typical specifications are at T_A = 25°C, V_{DD1} = V_{DD2} = 5 V.

Table 1.

Parameter	Symbol	Min	Typ	Max	Unit	Test Conditions
DC SPECIFICATIONS						
Input Supply Current, per Channel, Quiescent	I _{DD1(Q)}		0.50	0.53	mA	
Output Supply Current, per Channel, Quiescent	I _{DD0(Q)}		0.19	0.21	mA	
ADuM2400, Total Supply Current, Four Channels²						
DC to 2 Mbps						
V _{DD1} Supply Current	I _{DD1(Q)}		2.2	2.8	mA	DC to 1 MHz logic signal freq.
V _{DD2} Supply Current	I _{DD2(Q)}		0.9	1.4	mA	DC to 1 MHz logic signal freq.
10 Mbps (BRWZ and CRWZ Grades Only)						
V _{DD1} Supply Current	I _{DD1(10)}		8.6	10.6	mA	5 MHz logic signal freq.
V _{DD2} Supply Current	I _{DD2(10)}		2.6	3.5	mA	5 MHz logic signal freq.
90 Mbps (CRWZ Grade Only)						
V _{DD1} Supply Current	I _{DD1(90)}		76	100	mA	45 MHz logic signal freq.
V _{DD2} Supply Current	I _{DD2(90)}		21	25	mA	45 MHz logic signal freq.
ADuM2401, Total Supply Current, Four Channels²						
DC to 2 Mbps						
V _{DD1} Supply Current	I _{DD1(Q)}		1.8	2.4	mA	DC to 1 MHz logic signal freq.
V _{DD2} Supply Current	I _{DD2(Q)}		1.2	1.8	mA	DC to 1 MHz logic signal freq.
10 Mbps (BRWZ and CRWZ Grades Only)						
V _{DD1} Supply Current	I _{DD1(10)}		7.1	9.0	mA	5 MHz logic signal freq.
V _{DD2} Supply Current	I _{DD2(10)}		4.1	5.0	mA	5 MHz logic signal freq.
90 Mbps (CRWZ Grade Only)						
V _{DD1} Supply Current	I _{DD1(90)}		62	82	mA	45 MHz logic signal freq.
V _{DD2} Supply Current	I _{DD2(90)}		35	43	mA	45 MHz logic signal freq.
ADuM2402, Total Supply Current, Four Channels²						
DC to 2 Mbps						
V _{DD1} or V _{DD2} Supply Current	I _{DD1(Q),} I _{DD2(Q)}		1.5	2.1	mA	DC to 1 MHz logic signal freq.
10 Mbps (BRWZ and CRWZ Grades Only)						
V _{DD1} or V _{DD2} Supply Current	I _{DD1(10),} I _{DD2(10)}		5.6	7.0	mA	5 MHz logic signal freq.
90 Mbps (CRWZ Grade Only)						
V _{DD1} or V _{DD2} Supply Current	I _{DD1(90),} I _{DD2(90)}		49	62	mA	45 MHz logic signal freq.
For All Models						
Input Currents	I _{IA} , I _{IB} , I _{IC} , I _{ID} , I _{E1} , I _{E2}	-10	0.01	10	μA	0 ≤ V _{IA} , V _{IB} , V _{IC} , V _{ID} ≤ V _{DD1} or V _{DD2} , 0 ≤ V _{E1} , V _{E2} ≤ V _{DD1} or V _{DD2}
Logic High Input Threshold	V _{IH} , V _{EH}	2.0			V	
Logic Low Input Threshold	V _{IL} , V _{EL}			0.8	V	
Logic High Output Voltages	V _{OAH} , V _{OBH} , V _{OCH} , V _{ODH}	V _{DD1} , V _{DD2} - 0.1	5.0		V	I _{OX} = -20 μA, V _{IX} = V _{IXH}
		V _{DD1} , V _{DD2} - 0.4	4.8		V	I _{OX} = -4 mA, V _{IX} = V _{IXH}
Logic Low Output Voltages	V _{OAL} , V _{OBL} , V _{OCL} , V _{ODL}		0.0	0.1	V	I _{OX} = 20 μA, V _{IX} = V _{IXL}
			0.04	0.1	V	I _{OX} = 400 μA, V _{IX} = V _{IXL}
			0.2	0.4	V	I _{OX} = 4 mA, V _{IX} = V _{IXL}

Parameter	Symbol	Min	Typ	Max	Unit	Test Conditions
SWITCHING SPECIFICATIONS						
ADuM240xARW						
Minimum Pulsewidth ³	PW			1000	ns	C _L = 15 pF, CMOS signal levels
Maximum Data Rate ⁴		1			Mbps	C _L = 15 pF, CMOS signal levels
Propagation Delay ⁵	t _{PHL} , t _{PLH}	50	65	100	ns	C _L = 15 pF, CMOS signal levels
Pulsewidth Distortion, t _{PLH} - t _{PHL} ⁵	PWD			40	ns	C _L = 15 pF, CMOS signal levels
Propagation Delay Skew ⁶	t _{PSK}			50	ns	C _L = 15 pF, CMOS signal levels
Channel-to-Channel Matching ⁷	t _{PSKCD/OD}			50	ns	C _L = 15 pF, CMOS signal levels
ADuM240xBRW						
Minimum Pulsewidth ³	PW			100	ns	C _L = 15 pF, CMOS signal levels
Maximum Data Rate ⁴		10			Mbps	C _L = 15 pF, CMOS signal levels
Propagation Delay ⁵	t _{PHL} , t _{PLH}	20	32	50	ns	C _L = 15 pF, CMOS signal levels
Pulsewidth Distortion, t _{PLH} - t _{PHL} ⁵	PWD			3	ns	C _L = 15 pF, CMOS signal levels
Change Versus Temperature			5		ps/°C	C _L = 15 pF, CMOS signal levels
Propagation Delay Skew ⁶	t _{PSK}			15	ns	C _L = 15 pF, CMOS signal levels
Channel-to-Channel Matching, Co-Directional Channels ⁷	t _{PSKCD}			3	ns	C _L = 15 pF, CMOS signal levels
Channel-to-Channel Matching, Opposing-Directional Channels ⁷	t _{PSKOD}			6	ns	C _L = 15 pF, CMOS signal levels
ADuM240xCRW						
Minimum Pulsewidth ³	PW		8.3	11.1	ns	C _L = 15 pF, CMOS signal levels
Maximum Data Rate ⁴		90	120		Mbps	C _L = 15 pF, CMOS signal levels
Propagation Delay ⁵	t _{PHL} , t _{PLH}	18	27	32	ns	C _L = 15 pF, CMOS signal levels
Pulsewidth Distortion, t _{PLH} - t _{PHL} ⁵	PWD		0.5	2	ns	C _L = 15 pF, CMOS signal levels
Change Versus Temperature			3		ps/°C	C _L = 15 pF, CMOS signal levels
Propagation Delay Skew ⁶	t _{PSK}			10	ns	C _L = 15 pF, CMOS signal levels
Channel-to-Channel Matching, Co-Directional Channels ⁷	t _{PSKCD}			2	ns	C _L = 15 pF, CMOS signal levels
Channel-to-Channel Matching, Opposing-Directional Channels ⁷	t _{PSKOD}			5	ns	C _L = 15 pF, CMOS signal levels
For All Models						
Output Disable Propagation Delay (High/Low to High Impedance)	t _{PHZ} , t _{PLH}		6	8	ns	C _L = 15 pF, CMOS signal levels
Output Enable Propagation Delay (High Impedance to High/Low)	t _{PZH} , t _{PZL}		6	8	ns	C _L = 15 pF, CMOS signal levels
Output Rise/Fall Time (10%–90%)	t _r /t _f		2.5		ns	C _L = 15 pF, CMOS signal levels
Common-Mode Transient Immunity at Logic High Output ⁸	CM _H	25	35		kV/μs	V _{Ix} = V _{DD1/DD2} , V _{CM} = 1000 V, transient magnitude = 800 V
Common-Mode Transient Immunity at Logic Low Output ⁸	CM _L	25	35		kV/μs	V _{Ix} = 0 V, V _{CM} = 1000 V, transient magnitude = 800 V
Refresh Rate	f _r		1.2		Mbps	
Input Dynamic Supply Current, per Channel ⁹	I _{DDI(D)}		0.19		mA/Mbps	
Output Dynamic Supply Current, per Channel ⁹	I _{DDO(D)}		0.05		mA/Mbps	

See Notes on next page.

NOTES

- ¹ All voltages are relative to their respective ground.
- ² Supply current values are for all four channels combined running at identical data rates. Output supply current values are specified with no output load present. The supply current associated with an individual channel operating at a given data rate may be calculated as described in the Power Consumption section on page 20. See Figure 8 through Figure 10 for information on per-channel supply current as a function of data rate for unloaded and loaded conditions. See Figure 11 through Figure 14 for total I_{DD1} and I_{DD2} supply currents as a function of data rate for ADuM2400/ADuM2401/ADuM2402 channel configurations.
- ³ The minimum pulsewidth is the shortest pulsewidth at which the specified pulsewidth distortion is guaranteed.
- ⁴ The maximum data rate is the fastest data rate at which the specified pulsewidth distortion is guaranteed.
- ⁵ t_{PHL} propagation delay is measured from the 50% level of the falling edge of the V_{ix} signal to the 50% level of the falling edge of the V_{ox} signal. t_{PLH} propagation delay is measured from the 50% level of the rising edge of the V_{ix} signal to the 50% level of the rising edge of the V_{ox} signal.
- ⁶ t_{PSK} is the magnitude of the worst-case difference in t_{PHL} or t_{PLH} that will be measured between units at the same operating temperature, supply voltages, and output load within the recommended operating conditions.
- ⁷ Co-directional channel-to-channel matching is the absolute value of the difference in propagation delays between any two channels with inputs on the same side of the isolation barrier. Opposing-directional channel-to-channel matching is the absolute value of the difference in propagation delays between any two channels with inputs on opposing sides of the isolation barrier.
- ⁸ CM_H is the maximum common-mode voltage slew rate that can be sustained while maintaining $V_O > 0.8V_{DD2}$. CM_L is the maximum common-mode voltage slew rate than can be sustained while maintaining $V_O < 0.8V$. The common-mode voltage slew rates apply to both rising and falling common-mode voltage edges. The transient magnitude is the range over which the common mode is slewed.
- ⁹ Dynamic supply current is the incremental amount of supply current required for a 1 Mbps increase in signal data rate. See Figure 8 through Figure 10 for information on per-channel supply current for unloaded and loaded conditions. See Power Consumption section on page 19 for guidance on calculating per-channel supply current for a given data rate.

ELECTRICAL CHARACTERISTICS—3 V OPERATION¹

2.7 V ≤ V_{DD1} ≤ 3.6 V, 2.7 V ≤ V_{DD2} ≤ 3.6 V. All min/max specifications apply over the entire recommended operation range, unless otherwise noted. All typical specifications are at T_A = 25°C, V_{DD1} = V_{DD2} = 3.0 V.

Table 2.

Parameter	Symbol	Min	Typ	Max	Unit	Test Conditions
DC SPECIFICATIONS						
Input Supply Current, per Channel, Quiescent	I _{DD1(Q)}		0.26	0.31	mA	
Output Supply Current, per Channel, Quiescent	I _{DD0(Q)}		0.11	0.14	mA	
ADuM2400, Total Supply Current, Four Channels²						
DC to 2 Mbps						
V _{DD1} Supply Current	I _{DD1(Q)}		1.2	1.9	mA	DC to 1 MHz logic signal freq.
V _{DD2} Supply Current	I _{DD2(Q)}		0.5	0.9	mA	DC to 1 MHz logic signal freq.
10 Mbps (BRWZ and CRWZ Grades Only)						
V _{DD1} Supply Current	I _{DD1(10)}		4.5	6.5	mA	5 MHz logic signal freq.
V _{DD2} Supply Current	I _{DD2(10)}		1.4	2.0	mA	5 MHz logic signal freq.
90 Mbps (CRWZ Grade Only)						
V _{DD1} Supply Current	I _{DD1(90)}		42	65	mA	45 MHz logic signal freq.
V _{DD2} Supply Current	I _{DD2(90)}		11	15	mA	45 MHz logic signal freq.
ADuM2401, Total Supply Current, Four Channels²						
DC to 2 Mbps						
V _{DD1} Supply Current	I _{DD1(Q)}		1.0	1.6	mA	DC to 1 MHz logic signal freq.
V _{DD2} Supply Current	I _{DD2(Q)}		0.7	1.2	mA	DC to 1 MHz logic signal freq.
10 Mbps (BRWZ and CRWZ Grades Only)						
V _{DD1} Supply Current	I _{DD1(10)}		3.7	5.4	mA	5 MHz logic signal freq.
V _{DD2} Supply Current	I _{DD2(10)}		2.2	3.0	mA	5 MHz logic signal freq.
90 Mbps (CRWZ Grade Only)						
V _{DD1} Supply Current	I _{DD1(90)}		34	52	mA	45 MHz logic signal freq.
V _{DD2} Supply Current	I _{DD2(90)}		19	27	mA	45 MHz logic signal freq.
ADuM2402, Total Supply Current, Four Channels²						
DC to 2 Mbps						
V _{DD1} or V _{DD2} Supply Current	I _{DD1(Q), I_{DD2(Q)}}		0.9	1.5	mA	DC to 1 MHz logic signal freq.
10 Mbps (BRWZ and CRWZ Grades Only)						
V _{DD1} or V _{DD2} Supply Current	I _{DD1(10), I_{DD2(10)}}		3.0	4.2	mA	5 MHz logic signal freq.
90 Mbps (CRWZ Grade Only)						
V _{DD1} or V _{DD2} Supply Current	I _{DD1(90), I_{DD2(90)}}		27	39	mA	45 MHz logic signal freq.
For All Models						
Input Currents	I _{IA} , I _{IB} , I _{IC} , I _{ID} , I _{E1} , I _{E2}	-10	0.01	10	μA	0 ≤ V _{IA} , V _{IB} , V _{IC} , V _{ID} ≤ V _{DD1} or V _{DD2} , 0 ≤ V _{E1} , V _{E2} ≤ V _{DD1} or V _{DD2}
Logic High Input Threshold	V _{IH} , V _{EH}	1.6			V	
Logic Low Input Threshold	V _{IL} , V _{EL}			0.4	V	
Logic High Output Voltages	V _{OAH} , V _{OBH} , V _{OCH} , V _{ODH}	V _{DD1} , V _{DD2} - 0.1	3.0		V	I _{Ox} = -20 μA, V _{Ix} = V _{IxH}
		V _{DD1} , V _{DD2} - 0.4	2.8		V	I _{Ox} = -4 mA, V _{Ix} = V _{IxH}
Logic Low Output Voltages	V _{OAL} , V _{OBL} , V _{OCL} , V _{ODL}		0.0	0.1	V	I _{Ox} = 20 μA, V _{Ix} = V _{IxL}
			0.04	0.1	V	I _{Ox} = 400 μA, V _{Ix} = V _{IxL}
			0.2	0.4	V	I _{Ox} = 4 mA, V _{Ix} = V _{IxL}

Parameter	Symbol	Min	Typ	Max	Unit	Test Conditions
SWITCHING SPECIFICATIONS						
ADuM240xARW						
Minimum Pulswidth ³	PW			1000	ns	C _L = 15pF, CMOS signal levels
Maximum Data Rate ⁴		1			Mbps	C _L = 15pF, CMOS signal levels
Propagation Delay ⁵	t _{PHL} , t _{PLH}	50	75	100	ns	C _L = 15pF, CMOS signal levels
Pulswidth Distortion, t _{PLH} – t _{PHL} ⁵	PWD			40	ns	C _L = 15pF, CMOS signal levels
Propagation Delay Skew ⁶	t _{PSK}			50	ns	C _L = 15pF, CMOS signal levels
Channel-to-Channel Matching ⁷	t _{PSKCD/OD}			50	ns	C _L = 15pF, CMOS signal levels
ADuM240xBRW						
Minimum Pulswidth ³	PW			100	ns	C _L = 15pF, CMOS signal levels
Maximum Data Rate ⁴		10			Mbps	C _L = 15pF, CMOS signal levels
Propagation Delay ⁵	t _{PHL} , t _{PLH}	20	38	50	ns	C _L = 15pF, CMOS signal levels
Pulswidth Distortion, t _{PLH} – t _{PHL} ⁵	PWD			3	ns	C _L = 15pF, CMOS signal levels
Change Versus Temperature			5		ps/°C	C _L = 15pF, CMOS signal levels
Propagation Delay Skew ⁶	t _{PSK}			22	ns	C _L = 15pF, CMOS signal levels
Channel-to-Channel Matching, Co-Directional Channels ⁷	t _{PSKCD}			3	ns	C _L = 15pF, CMOS signal levels
Channel-to-Channel Matching, Opposing-Directional Channels ⁷	t _{PSKOD}			6	ns	C _L = 15pF, CMOS signal levels
ADuM240xCRW						
Minimum Pulswidth ³	PW		8.3	11.1	ns	C _L = 15pF, CMOS signal levels
Maximum Data Rate ⁴		90	120		Mbps	C _L = 15pF, CMOS signal levels
Propagation Delay ⁵	t _{PHL} , t _{PLH}	20	34	45	ns	C _L = 15pF, CMOS signal levels
Pulswidth Distortion, t _{PLH} – t _{PHL} ⁵	PWD		0.5	2	ns	C _L = 15pF, CMOS signal levels
Change Versus Temperature			3		ps/°C	C _L = 15pF, CMOS signal levels
Propagation Delay Skew ⁶	t _{PSK}			16	ns	C _L = 15pF, CMOS signal levels
Channel-to-Channel Matching, Co-Directional Channels ⁷	t _{PSKCD}			2	ns	C _L = 15pF, CMOS signal levels
Channel-to-Channel Matching, Opposing-Directional Channels ⁷	t _{PSKOD}			5	ns	C _L = 15pF, CMOS signal levels
For All Models						
Output Disable Propagation Delay (High/Low to High Impedance)	t _{PHZ} , t _{PLH}		6	8	ns	C _L = 15pF, CMOS signal levels
Output Enable Propagation Delay (High Impedance to High/Low)	t _{PZH} , t _{PZL}		6	8	ns	C _L = 15pF, CMOS signal levels
Output Rise/Fall Time (10%–90%)	t _r /t _f		3		ns	C _L = 15pF, CMOS signal levels
Common Mode Transient Immunity at Logic High Output ⁸	CM _H	25	35		kV/μs	V _{ix} = V _{DD1/DD2} , V _{CM} = 1000 V, transient magnitude = 800 V
Common Mode Transient Immunity at Logic Low Output ⁸	CM _L	25	35		kV/μs	V _{ix} = 0 V, V _{CM} = 1000 V, transient magnitude = 800 V
Refresh Rate	f _r		1.1		Mbps	
Input Dynamic Supply Current, per Channel ⁹	I _{DDH(D)}		0.10		mA/Mbps	
Output Dynamic Supply Current, per Channel ⁹	I _{DDO(D)}		0.03		mA/Mbps	

See Notes on next page.

NOTES

- ¹ All voltages are relative to their respective ground.
- ² Supply current values are for all four channels combined running at identical data rates. Output supply current values are specified with no output load present. The supply current associated with an individual channel operating at a given data rate may be calculated as described in the Power Consumption section on page 20. See Figure 8 through Figure 10 for information on per-channel supply current as a function of data rate for unloaded and loaded conditions. See Figure 11 through Figure 14 for total I_{DD1} and I_{DD2} supply currents as a function of data rate for ADuM2400/ADuM2401/ADuM2402 channel configurations.
- ³ The minimum pulsewidth is the shortest pulsewidth at which the specified pulsewidth distortion is guaranteed.
- ⁴ The maximum data rate is the fastest data rate at which the specified pulsewidth distortion is guaranteed.
- ⁵ t_{PHL} propagation delay is measured from the 50% level of the falling edge of the V_{ix} signal to the 50% level of the falling edge of the V_{ox} signal. t_{PLH} propagation delay is measured from the 50% level of the rising edge of the V_{ix} signal to the 50% level of the rising edge of the V_{ox} signal.
- ⁶ t_{PSK} is the magnitude of the worst-case difference in t_{PHL} or t_{PLH} that will be measured between units at the same operating temperature, supply voltages, and output load within the recommended operating conditions.
- ⁷ Co-directional channel-to-channel matching is the absolute value of the difference in propagation delays between any two channels with inputs on the same side of the isolation barrier. Opposing-directional channel-to-channel matching is the absolute value of the difference in propagation delays between any two channels with inputs on opposing sides of the isolation barrier.
- ⁸ CM_H is the maximum common-mode voltage slew rate that can be sustained while maintaining $V_O > 0.8V_{DD2}$. CM_L is the maximum common-mode voltage slew rate that can be sustained while maintaining $V_O < 0.8V$. The common-mode voltage slew rates apply to both rising and falling common-mode voltage edges. The transient magnitude is the range over which the common mode is slewed.
- ⁹ Dynamic supply current is the incremental amount of supply current required for a 1 Mbps increase in signal data rate. See Figure 8 through Figure 10 for information on per-channel supply current for unloaded and loaded conditions. See Power Consumption section on page 19 for guidance on calculating per-channel supply current for a given data rate.

ELECTRICAL CHARACTERISTICS—MIXED 5 V/3 V OR 3 V/5 V OPERATION¹

5 V/3 V operation: $4.5\text{ V} \leq V_{DD1} \leq 5.5\text{ V}$, $2.7\text{ V} \leq V_{DD2} \leq 3.6\text{ V}$. 3 V/5 V operation: $2.7\text{ V} \leq V_{DD1} \leq 3.6\text{ V}$, $4.5\text{ V} \leq V_{DD2} \leq 5.5\text{ V}$. All min/max specifications apply over the entire recommended operation range, unless otherwise noted.

All typical specifications are at $T_A=25^\circ\text{C}$; $V_{DD1} = 3.0\text{ V}$, $V_{DD2} = 5\text{ V}$; or $V_{DD1} = 5\text{ V}$, $V_{DD2} = 3.0\text{ V}$.

Table 3.

Parameter	Symbol	Min	Typ	Max	Unit	Test Conditions
DC SPECIFICATIONS						
Input Supply Current, per Channel, Quiescent	$I_{DD1(Q)}$					
5 V/3 V Operation			0.50	0.53	mA	
3 V/5 V Operation			0.26	0.31	mA	
Output Supply Current, per Channel, Quiescent	$I_{DD0(Q)}$					
5 V/3 V Operation			0.11	0.14	mA	
3 V/5 V Operation			0.19	0.21	mA	
ADuM2400, Total Supply Current, Four Channels²						
DC to 2 Mbps						
V_{DD1} Supply Current	$I_{DD1(Q)}$					
5 V/3 V Operation			2.2	2.8	mA	DC to 1 MHz logic signal freq.
3 V/5 V Operation			1.2	1.9	mA	DC to 1 MHz logic signal freq.
V_{DD2} Supply Current	$I_{DD2(Q)}$					
5 V/3 V Operation			0.5	0.9	mA	DC to 1 MHz logic signal freq.
3 V/5 V Operation			0.9	1.4	mA	DC to 1 MHz logic signal freq.
10 Mbps (BRWZ and CRWZ Grades Only)						
V_{DD1} Supply Current	$I_{DD1(10)}$					
5 V/3 V Operation			8.6	10.6	mA	5 MHz logic signal freq.
3 V/5 V Operation			4.5	6.5	mA	5 MHz logic signal freq.
V_{DD2} Supply Current	$I_{DD2(10)}$					
5 V/3 V Operation			1.4	2.0	mA	5 MHz logic signal freq.
3 V/5 V Operation			2.6	3.5	mA	5 MHz logic signal freq.
90 Mbps (CRWZ Grade Only)						
V_{DD1} Supply Current	$I_{DD1(90)}$					
5 V/3 V Operation			76	100	mA	45 MHz logic signal freq.
3 V/5 V Operation			42	65	mA	45 MHz logic signal freq.
V_{DD2} Supply Current	$I_{DD2(90)}$					
5 V/3 V Operation			11	15	mA	45 MHz logic signal freq.
3 V/5 V Operation			21	25	mA	45 MHz logic signal freq.
ADuM2401, Total Supply Current, Four Channels²						
DC to 2 Mbps						
V_{DD1} Supply Current	$I_{DD1(Q)}$					
5 V/3 V Operation			1.8	2.4	mA	DC to 1 MHz logic signal freq.
3 V/5 V Operation			1.0	1.6	mA	DC to 1 MHz logic signal freq.
V_{DD2} Supply Current	$I_{DD2(Q)}$					
5 V/3 V Operation			0.7	1.2	mA	DC to 1 MHz logic signal freq.
3 V/5 V Operation			1.2	1.8	mA	DC to 1 MHz logic signal freq.
10 Mbps (BRWZ and CRWZ Grades Only)						
V_{DD1} Supply Current	$I_{DD1(10)}$					
5 V/3 V Operation			7.1	9.0	mA	5 MHz logic signal freq.
3 V/5 V Operation			3.7	5.4	mA	5 MHz logic signal freq.
V_{DD2} Supply Current	$I_{DD2(10)}$					
5 V/3 V Operation			2.2	3.0	mA	5 MHz logic signal freq.
3 V/5 V Operation			4.1	5.0	mA	5 MHz logic signal freq.
90 Mbps (CRWZ Grade Only)						
V_{DD1} Supply Current	$I_{DD1(90)}$					

Parameter	Symbol	Min	Typ	Max	Unit	Test Conditions
5 V/3 V Operation			62	82	mA	45 MHz logic signal freq.
3 V/5 V Operation			34	52	mA	45 MHz logic signal freq.
V _{DD2} Supply Current	I _{DD2(90)}					
5 V/3 V Operation			19	27	mA	45 MHz logic signal freq.
3 V/5 V Operation			35	43	mA	45 MHz logic signal freq.
ADuM2402, Total Supply Current, Four Channels ²						
DC to 2 Mbps						
V _{DD1} Supply Current	I _{DD1(Q)}					
5 V/3 V Operation			1.5	2.1	mA	DC to 1 MHz logic signal freq.
3 V/5 V Operation			0.9	1.5	mA	DC to 1 MHz logic signal freq.
V _{DD2} Supply Current	I _{DD2(Q)}					
5 V/3 V Operation			0.9	1.5	mA	DC to 1 MHz logic signal freq.
3 V/5 V Operation			1.5	2.1	mA	DC to 1 MHz logic signal freq.
10 Mbps (BRWZ and CRWZ Grades Only)						
V _{DD1} Supply Current	I _{DD1(10)}					
5 V/3 V Operation			5.6	7.0	mA	5 MHz logic signal freq.
3 V/5 V Operation			3.0	4.2	mA	5 MHz logic signal freq.
V _{DD2} Supply Current	I _{DD2(10)}					
5 V/3 V Operation			3.0	4.2	mA	5 MHz logic signal freq.
3 V/5 V Operation			5.6	7.0	mA	5 MHz logic signal freq.
90 Mbps (CRWZ Grade Only)						
V _{DD1} Supply Current	I _{DD1(90)}					
5 V/3 V Operation			49	62	mA	45 MHz logic signal freq.
3 V/5 V Operation			27	39	mA	45 MHz logic signal freq.
V _{DD2} Supply Current	I _{DD2(90)}					
5 V/3 V Operation			27	39	mA	45 MHz logic signal freq.
3 V/5 V Operation			49	62	mA	45 MHz logic signal freq.
For All Models						
Input Currents	I _{IA} , I _{IB} , I _{IC} , I _{ID} , I _{E1} , I _{E2}	-10	0.01	10	μA	0 ≤ V _{IA} , V _{IB} , V _{IC} , V _{ID} ≤ V _{DD1} or V _{DD2} , 0 ≤ V _{E1} , V _{E2} ≤ V _{DD1} or V _{DD2}
Logic High Input Threshold	V _{IH} , V _{EH}					
5 V/3 V Operation		2.0			V	
3 V/5 V Operation		1.6			V	
Logic Low Input Threshold	V _{IL} , V _{EL}					
5 V/3 V Operation				0.8	V	
3 V/5 V Operation				0.4	V	
Logic High Output Voltages	V _{OAH} , V _{OBH} , V _{OCH} , V _{ODH}	V _{DD1} /V _{DD2} - 0.1	V _{DD1} / V _{DD2}		V	I _{Ox} = -20 μA, V _{Ix} = V _{IxH}
		V _{DD1} /V _{DD2} - 0.4	V _{DD1} / V _{DD2}		V	I _{Ox} = -4 mA, V _{Ix} = V _{IxH}
				-0.2	V	
Logic Low Output Voltages	V _{OAL} , V _{OBL} , V _{OCL} , V _{ODL}		0.0	0.1	V	I _{Ox} = 20 μA, V _{Ix} = V _{IxL}
			0.04	0.1	V	I _{Ox} = 400 μA, V _{Ix} = V _{IxL}
			0.2	0.4	V	I _{Ox} = 4 mA, V _{Ix} = V _{IxL}
SWITCHING SPECIFICATIONS						
ADuM240xARW						
Minimum Pulsewidth ³	PW			1000	ns	C _L = 15pF, CMOS signal levels
Maximum Data Rate ⁴		1			Mbps	C _L = 15pF, CMOS signal levels
Propagation Delay ⁵	t _{PHL} , t _{PLH}	50	70	100	ns	C _L = 15pF, CMOS signal levels
Pulsewidth Distortion, t _{PLH} - t _{PHL} ⁵	PWD			40	ns	C _L = 15pF, CMOS signal levels
Propagation Delay Skew ⁶	t _{PSK}			50	ns	C _L = 15pF, CMOS signal levels
Channel-to-Channel Matching ⁷	t _{PSKCD/OD}			50	ns	C _L = 15pF, CMOS signal levels
ADuM240xBRW						

Parameter	Symbol	Min	Typ	Max	Unit	Test Conditions
Minimum Pulsewidth ³	PW			100	ns	C _L = 15pF, CMOS signal levels
Maximum Data Rate ⁴		10			Mbps	C _L = 15pF, CMOS signal levels
Propagation Delay ⁵	t _{PHL} , t _{PLH}	15	35	50	ns	C _L = 15pF, CMOS signal levels
Pulsewidth Distortion, t _{PLH} - t _{PHL} ⁵	PWD			3	ns	C _L = 15pF, CMOS signal levels
Change Versus Temperature			5		ps/°C	C _L = 15pF, CMOS signal levels
Propagation Delay Skew ⁶	t _{PSK}			22	ns	C _L = 15pF, CMOS signal levels
Channel-to-Channel Matching, Co-Directional Channels ⁷	t _{PSKCD}			3	ns	C _L = 15pF, CMOS signal levels
Channel-to-Channel Matching, Opposing-Directional Channels ⁷	t _{PSKOD}			6	ns	C _L = 15pF, CMOS signal levels
ADuM240xCRW						
Minimum Pulsewidth ³	PW		8.3	11.1	ns	C _L = 15pF, CMOS signal levels
Maximum Data Rate ⁴		90	120		Mbps	C _L = 15pF, CMOS signal levels
Propagation Delay ⁵	t _{PHL} , t _{PLH}	20	30	40	ns	C _L = 15pF, CMOS signal levels
Pulsewidth Distortion, t _{PLH} - t _{PHL} ⁵	PWD		0.5	2	ns	C _L = 15pF, CMOS signal levels
Change Versus Temperature			3		ps/°C	C _L = 15pF, CMOS signal levels
Propagation Delay Skew ⁶	t _{PSK}			14	ns	C _L = 15pF, CMOS signal levels
Channel-to-Channel Matching, Co-Directional Channels ⁷	t _{PSKCD}			2	ns	C _L = 15pF, CMOS signal levels
Channel-to-Channel Matching, Opposing-Directional Channels ⁷	t _{PSKOD}			5	ns	C _L = 15pF, CMOS signal levels
For All Models						
Output Disable Propagation Delay (High/Low to High Impedance)	t _{PHZ} , t _{PLH}		6	8	ns	C _L = 15pF, CMOS signal levels
Output Enable Propagation Delay (High Impedance to High/Low)	t _{PZH} , t _{PZL}		6	8	ns	C _L = 15pF, CMOS signal levels
Output Rise/Fall Time (10-90%)	t _R /t _F					C _L = 15pF, CMOS signal levels
5 V/3 V Operation				3.0	ns	
3 V/5 V Operation				2.5	ns	
Common-Mode Transient Immunity at Logic High Output ⁸	CM _H	25	35		kV/μs	V _{ix} = V _{DD1/DD2} , V _{CM} = 1000 V, transient magnitude = 800 V
Common-Mode Transient Immunity at Logic Low Output ⁸	CM _L	25	35		kV/μs	V _{ix} = 0 V, V _{CM} = 1000 V, transient magnitude = 800 V
Refresh Rate	f _r					
5 V/3 V Operation				1.2	Mbps	
3 V/5 V Operation				1.1	Mbps	
Input Dynamic Supply Current, per Channel ⁹	I _{DDI(D)}					
5 V/3 V Operation				0.19	mA/Mbps	
3 V/5 V Operation				0.10	mA/Mbps	
Output Dynamic Supply Current, per Channel ⁹	I _{DDI(D)}					
5 V/3 V Operation				0.03	mA/Mbps	
3 V/5 V Operation				0.05	mA/Mbps	

See Notes on next page.

NOTES

- ¹ All voltages are relative to their respective ground.
- ² Supply current values are for all four channels combined running at identical data rates. Output supply current values are specified with no output load present. The supply current associated with an individual channel operating at a given data rate may be calculated as described in the Power Consumption section on page 20. See Figure 8 through Figure 10 for information on per-channel supply current as a function of data rate for unloaded and loaded conditions. See Figure 11 through Figure 14 for total I_{DD1} and I_{DD2} supply currents as a function of data rate for ADuM2400/ADuM2401/ADuM2402 channel configurations.
- ³ The minimum pulsewidth is the shortest pulsewidth at which the specified pulsewidth distortion is guaranteed.
- ⁴ The maximum data rate is the fastest data rate at which the specified pulsewidth distortion is guaranteed.
- ⁵ t_{PHL} propagation delay is measured from the 50% level of the falling edge of the V_{IK} signal to the 50% level of the falling edge of the V_{OK} signal. t_{PLH} propagation delay is measured from the 50% level of the rising edge of the V_{IK} signal to the 50% level of the rising edge of the V_{OK} signal.
- ⁶ t_{PSK} is the magnitude of the worst-case difference in t_{PHL} or t_{PLH} that will be measured between units at the same operating temperature, supply voltages, and output load within the recommended operating conditions.
- ⁷ Co-directional channel-to-channel matching is the absolute value of the difference in propagation delays between any two channels with inputs on the same side of the isolation barrier. Opposing-directional channel-to-channel matching is the absolute value of the difference in propagation delays between any two channels with inputs on opposing sides of the isolation barrier.
- ⁸ CM_H is the maximum common-mode voltage slew rate that can be sustained while maintaining $V_O > 0.8V_{DD2}$. CM_L is the maximum common-mode voltage slew rate that can be sustained while maintaining $V_O < 0.8V$. The common-mode voltage slew rates apply to both rising and falling common-mode voltage edges. The transient magnitude is the range over which the common mode is slewed.
- ⁹ Dynamic supply current is the incremental amount of supply current required for a 1 Mbps increase in signal data rate. See Figure 8 through Figure 10 for information on per-channel supply current for unloaded and loaded conditions. See Power Consumption section on page 19 for guidance on calculating per-channel supply current for a given data rate.

PACKAGE CHARACTERISTICS

Table 4.

Parameter	Symbol	Min	Typ	Max	Unit	Test Conditions
Resistance (Input-Output) ¹	R_{I-O}		10 ¹²		Ω	
Capacitance (Input-Output) ¹	C_{I-O}		2.2		pF	f = 1 MHz
Input Capacitance ²	C_i		4.0		pF	
IC Junction-to-Case Thermal Resistance, Side 1	θ_{Jc1}		33		°C/W	Thermocouple located at center of package underside
IC Junction-to-Case Thermal Resistance, Side 2	θ_{Jc2}		28		°C/W	

NOTES

¹ Device considered a two-terminal device: Pins 1, 2, 3, 4, 5, 6, 7, and 8 shorted together and Pins 9, 10, 11, 12, 13, 14, 15, and 16 shorted together.

² Input capacitance is from any input data pin to ground.

REGULATORY INFORMATION (PENDING)

The ADuM240x will approved upon product release by the following organizations:

Table 5.

UL ¹	CSA	VDE ²
Recognized under 1577 component recognition program ¹	Approved under CSA Component Acceptance Notice #5A	Certified according to DIN EN 60747-5-2 (VDE 0884 Part 2):2003-01 ²
Double insulation, 5000 V rms isolation voltage	Reinforced insulation per CSA 60950-1-03 and IEC 60950-1, 400 V rms maximum working voltage Approved per IEC 60601-1 Reinforced insulation, 250 V rms maximum working voltage	Basic insulation, 848 V peak Complies with DIN EN 60747-5-2 (VDE 0884 Part 2):2003-01, DIN EN 60950 (VDE 0805):2001-12; EN 60950:2000 Reinforced insulation, 565 V peak

NOTES

¹ In accordance with UL1577, each ADuM240x is proof tested by applying an insulation test voltage ≥ 6000 V rms for 1 second (current leakage detection limit = 5 μ A).

² In accordance with DIN EN 60747-5-2, each ADuM240x is proof tested by applying an insulation test voltage ≥ 1050 V peak for 1 second (partial discharge detection limit = 5 pC).

INSULATION AND SAFETY-RELATED SPECIFICATIONS

Table 6.

Parameter	Symbol	Value	Unit	Conditions
Rated Dielectric Insulation Voltage		5000	V rms	1 minute duration.
Minimum External Air Gap (Clearance)	L(I01)	7.45 min.	mm	Measured from input terminals to output terminals, shortest distance through air.
Minimum External Tracking (Creepage)	L(I02)	8.10 min.	mm	Measured from input terminals to output terminals, shortest distance path along body.
Minimum Internal Gap (Internal Clearance)		0.025 min.	mm	Insulation distance through insulation.
Tracking Resistance (Comparative Tracking Index)	CTI	>175	V	DIN IEC 112/VDE 0303 Part 1.
Isolation Group		IIIa		Material Group (DIN VDE 0110, 1/89, Table 1).

DIN EN 60747-5-2 (VDE 0884 PART 2) INSULATION CHARACTERISTICS (PENDING)

Table 7.

Description	Symbol	Characteristic	Unit
Installation classification per DIN VDE 0110 For Rated Mains Voltage ≤ 300 V rms For Rated Mains Voltage ≤ 600 V rms		I-IV I-III	
Climatic Classification		40/105/21	
Pollution Degree (DIN VDE 0110, Table 1)		2	
Maximum Working Insulation Voltage	V _{IORM}	848	V peak
Input to Output Test Voltage, Method b1 V _{IORM} × 1.875 = V _{PR} , 100% Production Test, t _m = 1 sec, Partial Discharge < 5 pC	V _{PR}	1590	V peak
Input to Output Test Voltage, Method a After Environmental Tests Subgroup 1) V _{IORM} × 1.6 = V _{PR} , t _m = 60 sec, Partial Discharge < 5p C After Input and/or Safety Test Subgroup 2/3) V _{IORM} × 1.2 = V _{PR} , t _m = 60 sec, Partial Discharge < 5p C	V _{PR}	1356 1018	V peak V peak
Highest Allowable Overvoltage (Transient Overvoltage, t _{TR} = 10 sec)	V _{TR}	6000	V peak
Safety-Limiting Values (Maximum value allowed in the event of a failure, also see Thermal Derating Curve, Figure 4) Case Temperature Side 1 Current Side 2 Current	T _S I _{S1} I _{S2}	150 265 335	°C mA mA
Insulation Resistance at T _S , V _{IO} = 500 V	R _S	>10 ⁹	Ω

This isolator is suitable for basic electrical isolation only within the safety limit data. Maintenance of the safety data shall be ensured by means of protective circuits.

"*" marking on packages denotes DIN EN 60747-5-2 approval for 560 V peak working voltage.

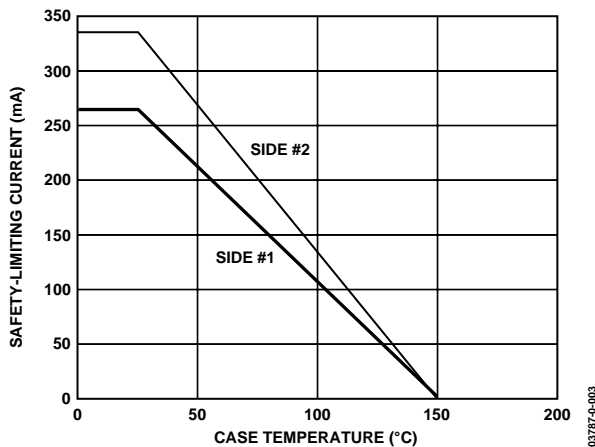

Figure 4. Thermal Derating Curve, Dependence of Safety Limiting Values with Case Temperature per DIN EN 60747-5-2

RECOMMENDED OPERATING CONDITIONS

Table 8.

Parameter	Symbol	Min	Max	Unit
Operating Temperature	T _A	-40	+105	°C
Supply Voltages ¹	V _{DD1} , V _{DD2}	2.7	5.5	V
Input Signal Rise and Fall Times			1.0	ms

NOTE

¹ All voltages are relative to their respective ground. See the DC Correctness and Magnetic Field Immunity section on page 19 for information on immunity to external magnetic fields.

ABSOLUTE MAXIMUM RATINGS

Table 9.

Parameter	Symbol	Min	Max	Unit
Storage Temperature	T_{ST}	-65	150	°C
Ambient Operating Temperature	T_A	-40	105	°C
Supply Voltages ¹	V_{DD1}, V_{DD2}	-0.5	7.0	V
Input Voltage ^{1,2}	$V_{IA}, V_{IB}, V_{IC}, V_{ID}, V_{E1}, V_{E2}$	-0.5	$V_{DD1} + 0.5$	V
Output Voltage ^{1,2}	$V_{OA}, V_{OB}, V_{OC}, V_{OD}$	-0.5	$V_{DDO} + 0.5$	V
Average Output Current, Per Pin ³				
Side 1	I_{O1}	-18	18	mA
Side 2	I_{O2}	-22	22	mA
Common-Mode Transients ⁴		-100	+100	kV/ μ s

NOTES

¹ All voltages are relative to their respective ground.

² V_{DD1} and V_{DDO} refer to the supply voltages on the input and output sides of a given channel, respectively. See PC Board Layout section.

³ See Figure 4 for maximum rated current values for various temperatures.

⁴ Refers to common-mode transients across the insulation barrier. Common-mode transients exceeding the Absolute Maximum Rating may cause latch-up or permanent damage.

Stresses above those listed under Absolute Maximum Ratings may cause permanent damage to the device. This is a stress rating only; functional operation of the device at these or any other conditions above those listed in the operational sections of this specification is not implied. Exposure to absolute maximum rating conditions for extended periods may affect device reliability. Ambient temperature = 25°C, unless otherwise noted.

Table 10. Truth Table (Positive Logic)

V_{IX} Input ¹	V_{EX} Input	V_{DD1} State ¹	V_{DDO} State ¹	V_{OX} Output ¹	Note
H	H or NC	Powered	Powered	H	
L	H or NC	Powered	Powered	L	
X	L	Powered	Powered	Z	
X	H or NC	Unpowered	Powered	H	Outputs returns to input state within 1 μ s of V_{DD1} power restoration.
X	L	Unpowered	Powered	Z	
X	X	Powered	Unpowered	Indeterminate	Outputs returns to input state within 1 μ s of V_{DDO} power restoration if V_{EX} state is H or NC. Outputs returns to high impedance state within 8 ns of V_{DDO} power restoration if V_{EX} state is L.

NOTE

¹ V_{IX} and V_{OX} refer to the input and output signals of a given channel (A, B, C, or D). V_{EX} refers to the output enable signal on the same side as the V_{OX} outputs. V_{DD1} and V_{DDO} refer to the supply voltages on the input and output sides of the given channel, respectively.

PIN CONFIGURATIONS AND PIN FUNCTION DESCRIPTIONS

PIN CONFIGURATIONS

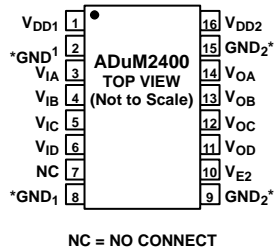

Figure 5. ADuM2400 Pin Configuration

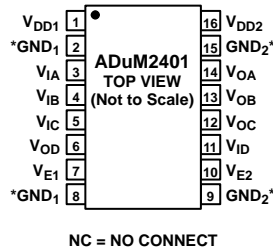

Figure 6. ADuM2401 Pin Configuration

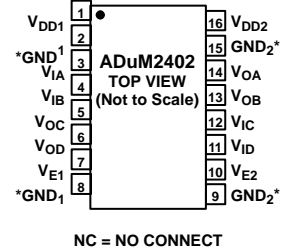

Figure 7. ADuM2402 Pin Configuration

* Pins 2 and 8 are internally connected. Connecting both to GND₁ is recommended. Pins 9 and 15 are internally connected. Connecting both to GND₂ is recommended. Output enable Pin 10 on the ADuM2400 may be left disconnected if outputs are to be always enabled. Output enable Pins 7 and 10 on the ADuM2401/ADuM2402 may be left disconnected if outputs are to be always enabled. In noisy environments, connecting Pin 7 (for ADuM2401 and ADuM2402) and Pin 10 (for all models) to an external logic high or low is recommended.

PIN FUNCTION DESCRIPTIONS

Table 11. ADuM2400 Pin Function Descriptions

Pin No.	Mnemonic	Function
1	V _{DD1}	Supply voltage for isolator Side 1, 2.7 V to 5.5 V.
2	GND ₁	Ground 1. Ground reference for isolator Side 1.
3	V _{IA}	Logic input A.
4	V _{IB}	Logic input B.
5	V _{IC}	Logic input C.
6	V _{ID}	Logic input D.
7	NC	No Connect.
8	GND ₁	Ground 1. Ground reference for isolator Side 1.
9	GND ₂	Ground 2. Ground reference for isolator Side 2.
10	V _{E2}	Output enable 2. Active high logic input. V _{OA} , V _{OB} , V _{OC} , and V _{OD} outputs are enabled when V _{E2} is high or disconnected. V _{OA} , V _{OB} , V _{OC} , and V _{OD} outputs are disabled when V _{E2} is low.
11	V _{OD}	Logic output D.
12	V _{OC}	Logic output C.
13	V _{OB}	Logic output B.
14	V _{OA}	Logic output A.
15	GND ₂	Ground 2. Ground reference for isolator Side 2.
16	V _{DD2}	Supply voltage for isolator Side 2, 2.7 V to 5.5 V.

Table 13. ADuM2402 Pin Function Descriptions

Pin No.	Mnemonic	Function
1	V _{DD1}	Supply voltage for isolator Side 1, 2.7 V to 5.5 V.
2	GND ₁	Ground 1. Ground reference for isolator Side 1.
3	V _{IA}	Logic input A.
4	V _{IB}	Logic input B.
5	V _{OC}	Logic output C.
6	V _{OD}	Logic output D.
7	V _{E1}	Output enable 1. Active high logic input. V _{OC} and V _{OD} outputs are enabled when V _{E1} is high or disconnected. V _{OC} and V _{OD} outputs are disabled when V _{E1} is low.
8	GND ₁	Ground 1. Ground reference for isolator Side 1.
9	GND ₂	Ground 2. Ground reference for isolator Side 2.
10	V _{E2}	Output enable 2. Active high logic input. V _{OA} and V _{OB} outputs are enabled when V _{E2} is high or disconnected. V _{OA} and V _{OB} outputs are disabled when V _{E2} is low.
11	V _{ID}	Logic input D.
12	V _{IC}	Logic input C.
13	V _{OB}	Logic output B.
14	V _{OA}	Logic output A.
15	GND ₂	Ground 2. Ground reference for isolator Side 2.
16	V _{DD2}	Supply voltage for isolator Side 2, 2.7 V to 5.5 V.

Table 12. ADuM2401 Pin Function Descriptions

Pin No.	Mnemonic	Function
1	V _{DD1}	Supply voltage for isolator Side 1, 2.7 V to 5.5 V.
2	GND ₁	Ground 1. Ground reference for isolator Side 1.
3	V _{IA}	Logic input A.
4	V _{IB}	Logic input B.
5	V _{IC}	Logic input C.
6	V _{OD}	Logic output D.
7	V _{E1}	Output enable 1. Active high logic input. V _{OD} output is enabled when V _{E1} is high or disconnected. V _{OD} is disabled when V _{E1} is low.
8	GND ₁	Ground 1. Ground reference for isolator Side 1.
9	GND ₂	Ground 2. Ground reference for isolator Side 2.
10	V _{E2}	Output enable 2. Active high logic input. V _{OA} , V _{OB} , and V _{OC} outputs are enabled when V _{E2} is high or disconnected. V _{OA} , V _{OB} , and V _{OC} outputs are disabled when V _{E2} is low.
11	V _{ID}	Logic input D.
12	V _{OC}	Logic output C.
13	V _{OB}	Logic output B.
14	V _{OA}	Logic output A.
15	GND ₂	Ground 2. Ground reference for isolator Side 2.
16	V _{DD2}	Supply voltage for isolator Side 1, 2.7 V to 5.5 V.

TYPICAL PERFORMANCE CHARACTERISTICS

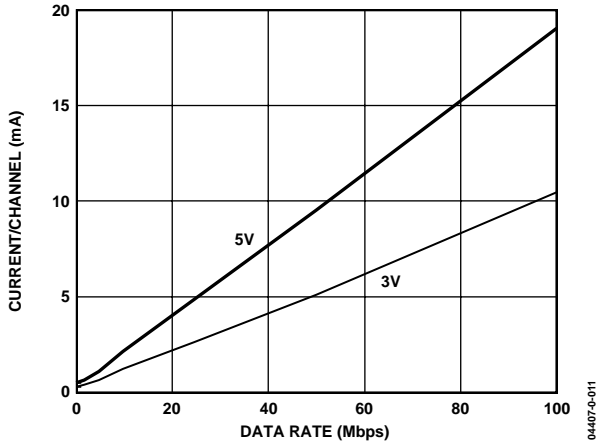

Figure 8. Typical Input Supply Current per Channel vs. Data Rate for 5 V and 3 V Operation

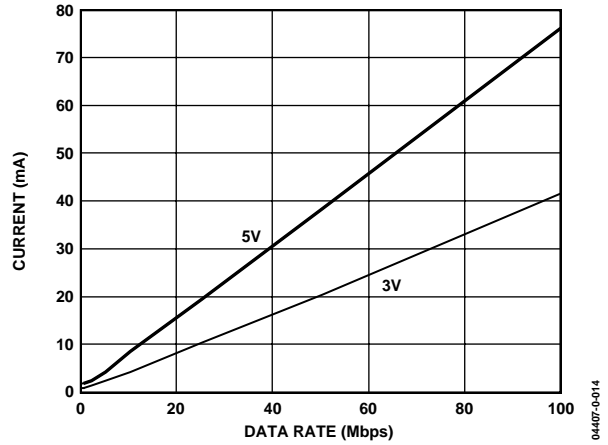

Figure 11. Typical ADuM2400 V_{DD1} Supply Current vs. Data Rate for 5 V and 3 V Operation

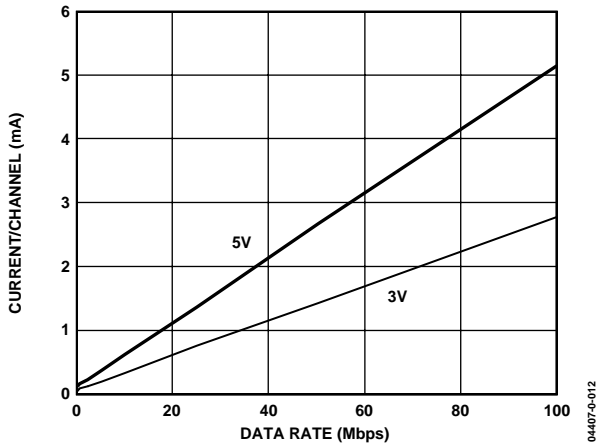

Figure 9. Typical Output Supply Current per Channel vs. Data Rate for 5 V and 3 V Operation (No Output Load)

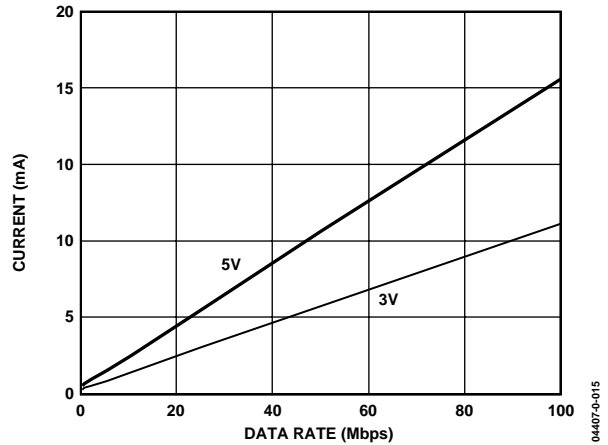

Figure 12. Typical ADuM2400 V_{DD2} Supply Current vs. Data Rate for 5 V and 3 V Operation

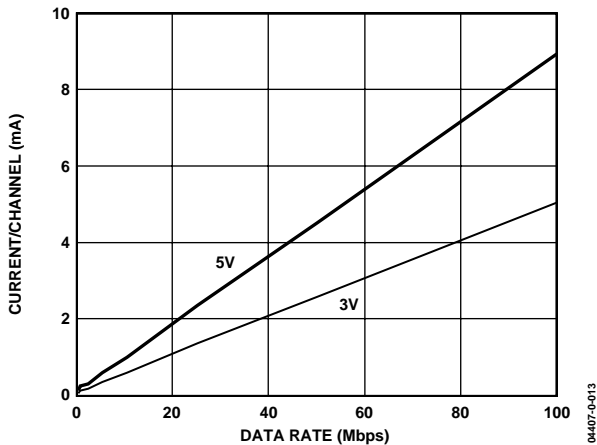

Figure 10. Typical Output Supply Current per Channel vs. Data Rate for 5 V and 3 V Operation (15 pF Output Load)

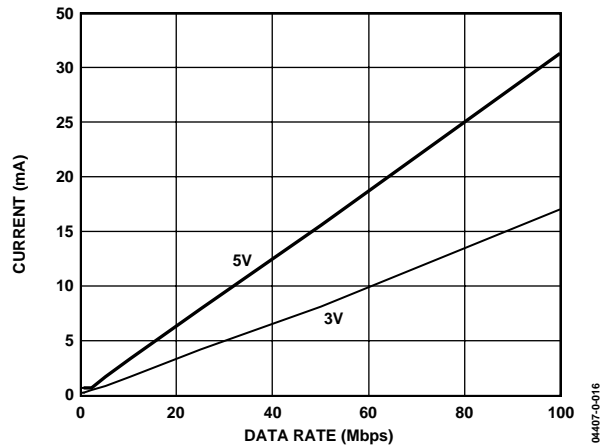

Figure 13. Typical ADuM2401 V_{DD1} Supply Current vs. Data Rate for 5 V and 3 V Operation

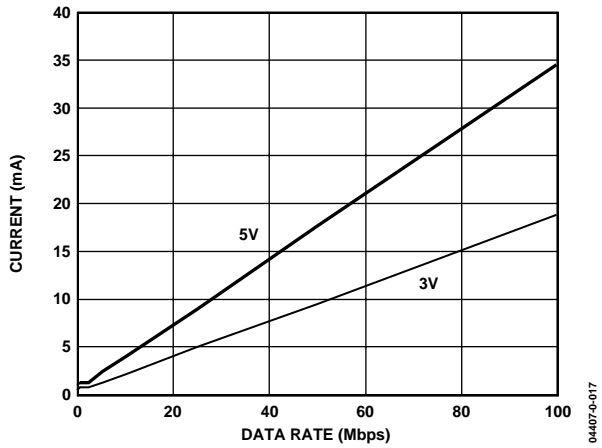

Figure 14. Typical ADuM2401 V_{DD2} Supply Current vs. Data Rate for 5 V and 3 V Operation

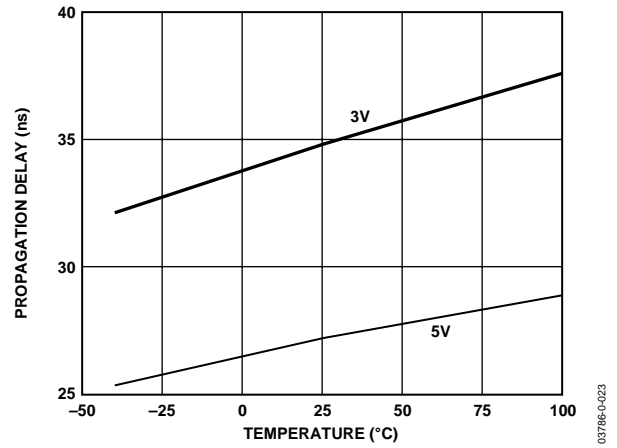

Figure 16. Propagation Delay vs. Temperature, C Grade.

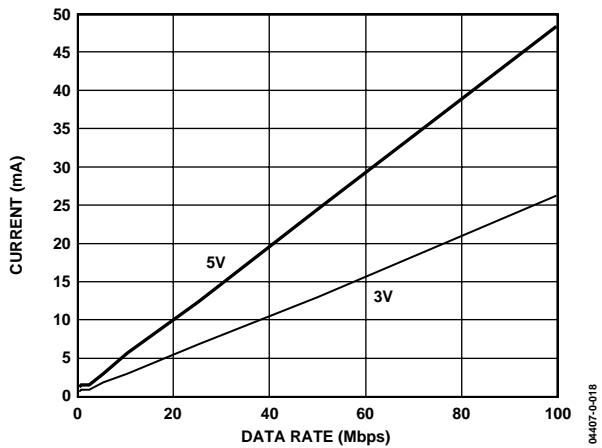

Figure 15. Typical ADuM2402 V_{DD1} or V_{DD2} Supply Current vs. Data Rate for 5 V and 3 V Operation

APPLICATION INFORMATION

PC BOARD LAYOUT

The ADuM240x digital isolator requires no external interface circuitry for the logic interfaces. Power supply bypassing is strongly recommended at the input and output supply pins (Figure 17). Bypass capacitors are most conveniently connected between Pins 1 and 2 for V_{DD1} and between Pins 15 and 16 for V_{DD2}. The capacitor value should be between 0.01 μF and 0.1 μF. The total lead length between both ends of the capacitor and the input power supply pin should not exceed 20 mm. Bypassing between Pins 1 and 8 and between Pins 9 and 16 should also be considered unless the ground pair on each package side are connected close to the package.

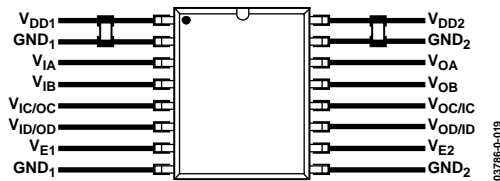

Figure 17. Recommended Printed Circuit Board Layout

In applications involving high common-mode transients, care should be taken to ensure that board coupling across the isolation barrier is minimized. Furthermore, the board layout should be designed such that any coupling that does occur equally affects all pins on a given component side. Failure to ensure this could cause voltage differentials between pins exceeding the device's Absolute Maximum Ratings, thereby leading to latch-up or permanent damage.

PROPAGATION DELAY-RELATED PARAMETERS

Propagation delay is a parameter that describes the length of time it takes for a logic signal to propagate through a component. The propagation delay to a logic low output may differ from the propagation delay to a logic high.

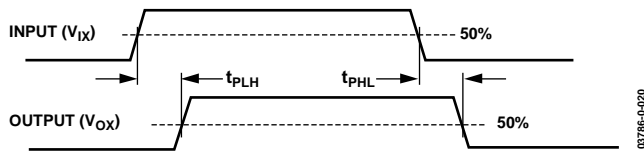

Figure 18. Propagation Delay Parameters

Pulsewidth distortion is the maximum difference between these two propagation delay values and is an indication of how accurately the input signal's timing is preserved.

Channel-to-channel matching refers to the maximum amount the propagation delay differs among channels within a single ADuM240x component.

Propagation delay skew refers to the maximum amount the propagation delay differs among multiple ADuM240x components operated under the same conditions.

DC CORRECTNESS AND MAGNETIC FIELD IMMUNITY

Positive and negative logic transitions at the isolator input cause narrow (~1 ns) pulses to be sent via the transformer to the decoder. The decoder is bistable and is therefore either set or reset by the pulses indicating input logic transitions. In the absence of logic transitions at the input for more than 2 μs, a periodic set of "refresh" pulses indicative of the correct input state are sent to ensure "dc correctness" at the output. If the decoder receives no pulses for more than about 5 μs, the input side is assumed to be unpowered or nonfunctional, in which case the isolator output is forced to a default state (see Table 10) by the watchdog timer circuit.

The limitation on the ADuM240x's magnetic field immunity is set by the condition in which induced voltage in the transformer's "receiving" coil is sufficiently large to either falsely set or reset the decoder. The analysis below defines the conditions under which this may occur. The 3 V operating condition of the ADuM240x is examined as it represents the most susceptible mode of operation.

The pulses at the transformer output have an amplitude greater than 1.0 V. The decoder has a sensing threshold at about 0.5 V, therefore establishing a 0.5 V margin in which induced voltages can be tolerated. The voltage induced across the "receiving" coil is given by:

$$V = (-d\beta/dt) \sum \Pi r_n^2; n = 1, 2, \dots, N$$

where:

β is magnetic flux density (gauss)

N is the number of turns in the receiving coil.

r_n is the radius of the n^{th} turn in the receiving coil (cm).

Given the geometry of the receiving coil in the ADuM240x and an imposed requirement that the induced voltage be at most 50% of the 0.5 V margin at the decoder, a maximum allowable magnetic field is calculated as shown in below in Figure 19.

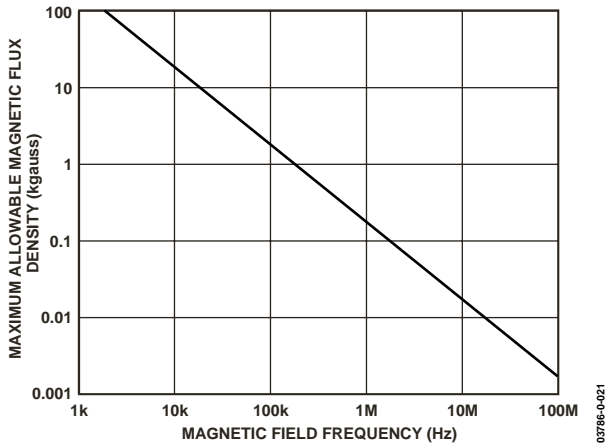

Figure 19. Maximum Allowable External Magnetic Flux Density

For example, at a magnetic field frequency of 1 MHz, the maximum allowable magnetic field of 0.2 kgauss induces a voltage of 0.25 V at the receiving coil. This is about 50% of the sensing threshold and will not cause a faulty output transition. Similarly, if such an event were to occur during a transmitted pulse (and was of the worst case polarity) it would reduce the received pulse from > 1.0 V to 0.75 V—still well above the 0.5 V sensing threshold of the decoder.

The preceding magnetic flux density values correspond to specific current magnitudes at given distances away from the ADuM240x transformers. Figure 20 expresses these allowable current magnitudes as a function of frequency for selected distances. As can be seen, the ADuM240x is extremely immune and can be affected only by extremely large currents operated at high frequency and very close to the component. For the 1 MHz example noted, one would have to place a 0.5 kA current 5 mm away from the ADuM240x to affect the component's operation.

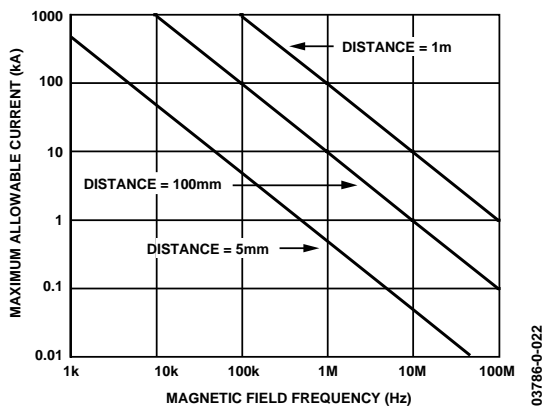

Figure 20. Maximum Allowable Current for Various Current-to-ADuM240x Spacings

Note that at combinations of strong magnetic field and high frequency, any loops formed by printed circuit board traces could induce sufficiently large error voltages to trigger the thresholds of succeeding circuitry. Care should be taken in the layout of such traces to avoid this possibility.

POWER CONSUMPTION

The supply current at a given channel of the ADuM240x isolator is a function of the supply voltage, the channel's data rate, and the channel's output load.

For each input channel, the supply current is given by:

$$I_{DDI} = I_{DDI(Q)} \quad f \leq 0.5f_r$$

$$I_{DDI} = I_{DDI(D)} \times (2f - f_r) + I_{DDI(Q)} \quad f > 0.5f_r$$

For each output channel, the supply current is given by:

$$I_{DDO} = I_{DDO(Q)} \quad f \leq 0.5f_r$$

$$I_{DDO} = (I_{DDO(D)} + (0.5 \times 10^{-3} \times C_L V_{DDO}) \times (2f - f_r) + I_{DDO(Q)}) \quad f > 0.5f_r$$

where:

$I_{DDI(D)}$, $I_{DDO(D)}$ are the input and output dynamic supply currents per channel (mA/Mbps).

C_L is output load capacitance (pF).

V_{DDO} is the output supply voltage (V).

f is the input logic signal frequency (MHz, half of the input data rate, NRZ signaling).

f_r is the input stage refresh rate (Mbps).

$I_{DDI(Q)}$, $I_{DDO(Q)}$ are the specified input and output quiescent supply currents (mA).

To calculate the total I_{DD1} and I_{DD2} supply current, the supply currents for each input and output channel corresponding to I_{DD1} and I_{DD2} are calculated and totaled. Figure 8 and Figure 9 provide per-channel supply currents as a function of data rate for an unloaded output condition. Figure 10 provides per-channel supply current as a function of data rate for a 15 pF output condition. Figure 11 through Figure 14 provide total I_{DD1} and I_{DD2} supply current as a function of data rate for ADuM2400/ADuM2401/ADuM2402 channel configurations.

OUTLINE DIMENSIONS

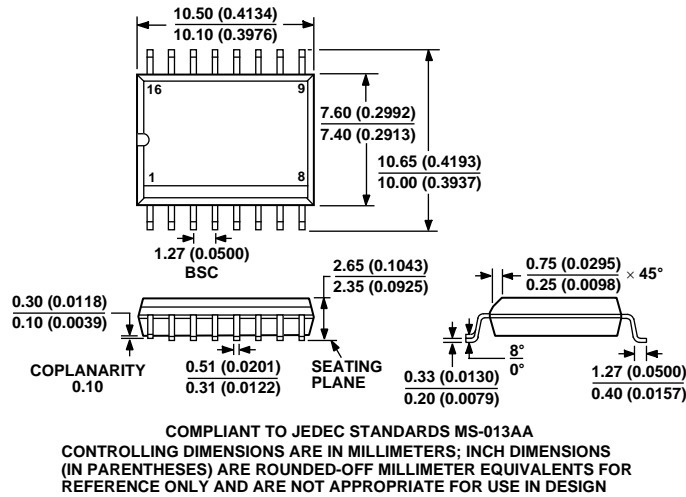

Figure 21. 16-Lead Standard Small Outline Package [SOIC]— Wide Body (RW-16)

ESD CAUTION

ESD (electrostatic discharge) sensitive device. Electrostatic charges as high as 4000 V readily accumulate on the human body and test equipment and can discharge without detection. Although this product features proprietary ESD protection circuitry, permanent damage may occur on devices subjected to high energy electrostatic discharges. Therefore, proper ESD precautions are recommended to avoid performance degradation or loss of functionality.



ORDERING GUIDE

Model	Number of Inputs, V _{DD1} Side	Number of Inputs, V _{DD2} Side	Maximum Data Rate (Mbps)	Maximum Propagation Delay, 5 V (ns)	Maximum Pulswidth Distortion (ns)	Channel-to-Channel Matching, Co-Directional Channels (ns)	Package Description
ADuM2400ARWZ*	4	0	1	100	40	40	16-Lead Wide Body SOIC, Pb-Free
ADuM2400BRWZ*	4	0	10	50	3	3	16-Lead Wide Body SOIC, Pb-Free
ADuM2400CRWZ*	4	0	100	32	2	2	16-Lead Wide Body SOIC, Pb-Free
ADuM2401ARWZ*	3	1	1	100	40	40	16-Lead Wide Body SOIC, Pb-Free
ADuM2401BRWZ*	3	1	10	50	3	3	16-Lead Wide Body SOIC, Pb-Free
ADuM2401CRWZ*	3	1	100	32	2	2	16-Lead Wide Body SOIC, Pb-Free
ADuM2402ARWZ*	2	2	1	100	40	40	16-Lead Wide Body SOIC, Pb-Free
ADuM2402BRWZ*	2	2	10	50	3	3	16-Lead Wide Body SOIC, Pb-Free
ADuM2402CRWZ*	2	2	100	32	2	2	16-Lead Wide Body SOIC, Pb-Free

*Tape and Reel is available. The addition of an "-RL" suffix designates a 13" (1000 units) tape and reel option.

NOTES

NOTES