

High Speed LDO Regulators, Low ESR Cap. Compatible, ON/OFF Switch

■ GENERAL DESCRIPTION

The XC6219/XC6211 series are highly accurate, low noise, CMOS LDO Voltage Regulators. Offering low output noise, high ripple rejection ratio, low dropout and very fast turn-on times, the XC6219/6211 series is ideal for today's cutting edge mobile phone. Internally the XC6219/6211 includes a reference voltage source, error amplifiers, driver transistors, current limiters and phase compensators. The XC6219/6211's current limiters' foldback circuit also operates as a short protect for the output current limiter and the output pin. The output voltage is set by laser trimming. Voltages are selectable in 50mV steps within a range of 0.9V to 5.0V. The XC6219/6211 series is also fully compatible with low ESR ceramic capacitors, reducing cost and improving output stability. This high level of output stability is maintained even during frequent load fluctuations, due to the excellent transient response performance and high PSRR achieved across a broad range of frequencies. The CE function allows the output of regulator to be turned off, resulting in greatly reduced power consumption.

■ APPLICATIONS

- Mobile phones
- Cordless phones, radio communication equipment
- Portable games
- Cameras, Video cameras
- Reference voltage sources
- Battery powered equipment

■ FEATURES

Maximum Output Current	: 150mA ($V_{OUT} < 1.75V$, A~D type)
	: 240mA ($V_{OUT} \geq 1.8V$, A~D type)
	: 300mA ($V_{OUT} \geq 1.3V$, E~H type)
Dropout Voltage	: 200mV @ $I_{OUT} = 100mA$
Operating Voltage Range	: 2.0V ~ 6.0V
Output Voltage Range	: 0.9V ~ 5.0V (50mV steps)
Highly Accuracy	: $\pm 2\%$ ($V_{OUT} > 1.5V$)
	: $\pm 30mV$ ($V_{OUT} \leq 1.5V$)
	: $\pm 1\%$ ($V_{OUT} \geq 3.0V$)
Low Power Consumption	: 25 μA (TYP.)
Standby Current	: Less than 0.1 μA (TYP.)
High Ripple Rejection	: 65dB @ 10kHz
Operating Temperature Range	
Low ESR Capacitor	: Ceramic capacitor compatible
Ultra Small Packages	: SOT-25 (SOT-23-5)
	: SOT-89-5 (for XC6219 only)
	: USP-6B (for XC6219 only)

■ TYPICAL APPLICATION CIRCUIT

- XC6219 series

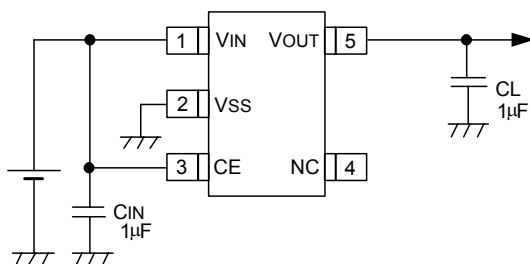

SOT-25 (SOT-23-5)

■ TYPICAL PERFORMANCE CHARACTERISTICS

- Ripple Rejection Rate

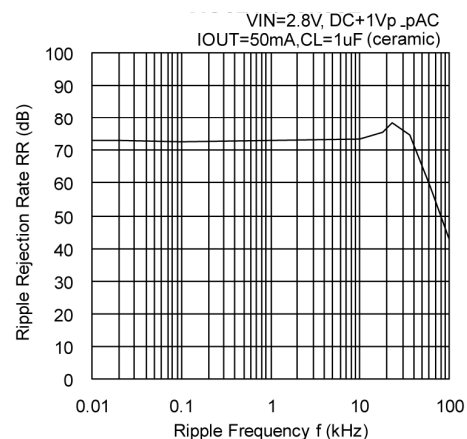

PIN CONFIGURATION

[XC6219 Series]

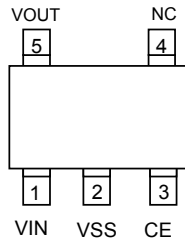

SOT-25 (SOT-23-5)
(TOP VIEW)

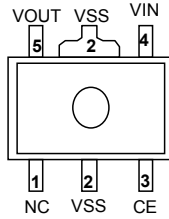

SOT-89-5
(TOP VIEW)

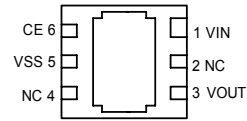

USP-6B
(BOTTOM VIEW)

* The dissipation pad for the USP-6B package should be solder-plated in recommended mount pattern and metal masking so as to enhance mounting strength and heat release.

[XC6211 Series]

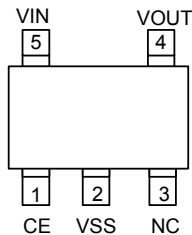

SOT-25 (SOT-23-5)
(TOP VIEW)

PIN ASSIGNMENT

PIN NUMBER				PIN NAME	FUNCTIONS
XC6211	XC6219				
SOT-25	SOT-25	SOT-89-5	USP-6B		
5	1	4	1	VIN	Power Input
2	2	2	5	VSS	Ground
1	3	3	6	CE	ON / OFF Control
3	4	1	2, 4	NC	No Connection
4	5	5	3	VOUT	Output

FUNCTION

SERIES	CE	OPERATIONAL STATE
A, B, E, F Series	H	ON
	L	OFF
C, D, G, H Series	H	OFF
	L	ON

H=High Level

L=Low Level

■ PRODUCT CLASSIFICATION

● Selection Guide

The following options for the CE pin logic and internal pull-up/down are available:

High Active + no pull-down resistor built-in (standard)

High Active + 2.0MΩ pull-down resistor built-in <between CE-Vss> (semi-custom)

Low Active + no pull-up resistor built-in (semi-custom)

Low Active + 2.0MΩ pull-up resistor built-in <between VIN-CE> (semi-custom)

Note: *With the pull-up resistor or pull-down resistor built-in types, the supply current during operation will increase by $V_{IN} / 2.0M\Omega$ (TYP.)

● Ordering Information

XC6219/XC6211 ①②③④⑤⑥

DESIGNATOR	DESCRIPTION	SYMBOL	DESCRIPTION
① (*1)	CE Pin Logic	A / E	: High Active, pull-down resistor built in (Semi-custom)
		B / F	: High Active, no pull-down resistor built in (Standard)
		C / G	: Low Active, pull-up resistor built in (Semi-custom)
		D / H	: Low Active, no pull-up resistor built in (Semi-custom)
② ③	Output Voltage	09~50	: e.g. ②=3, ③=0, → 3.0V
④	Output Voltage Accuracy	1 / 2	: 100mV increments, ±2% accuracy e.g. ③=2, ③=8, ④=2 → 2.80V, ±2%
		1 (*2)	: 100mV increments, ±1% accuracy e.g. ②=2, ③=8, ④=1 → 2.80V, ±1%
		A	: 50mV increments, ±2% accuracy e.g. ②=2, ③=8, ④=A → 2.85V, ±2%
		B (*2)	: 50mV increments, ±1% accuracy e.g. ②=2, ③=8, ④=B → 2.85V, ±1%
⑤	Packages	M	: SOT-25 (SOT-23-5)
		P	: SOT-89-5 (for XC6219 only)
		D	: USP-6B (for XC6219 only)
⑥	Device Orientation	R	: Embossed tape, standard feed
		L	: Embossed tape, reverse feed

NOTE :

*1 : Maximum output current of XC6219/6211 E to H series is 300mA.

*2 : Output voltage of the ±1% accuracy product is 3.0V or more.

■ BLOCK DIAGRAM

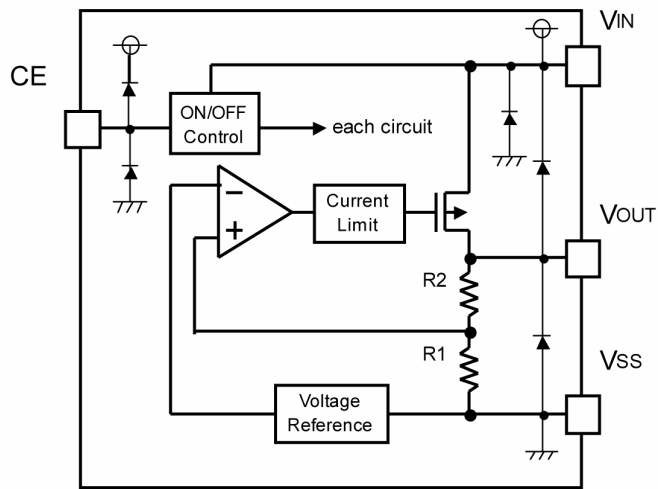

■ ABSOLUTE MAXIMUM RATINGS

Ta=25°C

PARAMETER	SYMBOL	RATINGS	UNITS
Input Voltage	V _{IN}	7.0	V
Output Current	I _{OUT}	500	mA
Output Voltage	V _{OUT}	V _{SS} - 0.3 ~ V _{IN} + 0.3	V
CE Pin Voltage	V _{CE}	V _{SS} - 0.3 ~ V _{IN} + 0.3	V
Power Dissipation	SOT-25	250	mW
	SOT-89	500	
	USP-6B	100	
Operating Temperature Range	T _{opr}	- 40 ~ + 85	°C
Storage Temperature Range	T _{stg}	- 55 ~ + 125	°C

■ ELECTRICAL CHARACTERISTICS

● XC6219/6211 series

Ta=25°C

PARAMETER	SYMBOL	CONDITIONS	MIN.	TYP.	MAX.	UNITS	CIRCUIT	
Output Voltage	V _{OUT(E)}	I _{OUT} =30mA (*1, 2, 8)	x 0.98	V _{OUT(T)}	x 1.02	V	①	
		1% accuracy=V _{OUT(T)} ≥3.0V	x 0.99		x 1.01			
Maximum Output Current	I _{OUTMAX}	Input conditions (E-1)	E-2	-	-	mA	①	
Load Regulation	ΔV _{OUT}	1mA ≤ I _{OUT} ≤ 100mA	-	15	50	mV	①	
Dropout Voltage	V _{dif1}	I _{OUT} =30mA (*3, 4, 5)	E-3			mV	①	
	V _{dif2}	I _{OUT} =100mA (*3, 4, 5)	E-4			mV		
Supply Current	I _{DD}	V _{CE} =V _{IN}	-	25	50	μA	②	
Stand-by Current	I _{stby}	V _{CE} =V _{SS}	-	0.01	0.10	μA	②	
Line Regulation	$\frac{\Delta V_{OUT}}{\Delta V_{IN} \cdot V_{OUT}}$	V _{OUT(T)} +1.0V ≤ V _{IN} ≤ 7.0V I _{OUT} =30mA	-	0.01	0.20	%/V	①	
Input Voltage	V _{IN}		2.0	-	6.0	V	-	
Output Voltage Temperature Characteristics	$\frac{\Delta V_{OUT}}{\Delta T_{opr} \cdot V_{OUT}}$	I _{OUT} =30mA -40°C ≤ T _{opr} ≤ 85°C	-	100	-	ppm/°C	①	
Ripple Rejection Rate	PSRR	I _{OUT} =50mA, f=10kHz V _{OUT(E)} ≥1.8V	-	65	-	dB	④	
			-	70	-			
Current Limiter	I _{lim}	XC6219/6211A~D type (*7)	-	300	-	mA	①	
		XC6219/6211 E~H type (*7)	-	380	-			
Short Circuit Current	I _{short}		-	50	-	mA	①	
CE 'High' Level Voltage	V _{CEH}		1.60	-	V _{IN}	V	①	
CE 'Low' Level Voltage	V _{CEL}		-	-	0.25	V	②	
CE 'High' Level Current	I _{CEH}	V _{CE} =V _{IN}	-0.10	-	XC6219/11A, E	5.0	μA	②
					XC6219/11B, C, D, F, G, H	0.10		
CE 'Low' Level Current	I _{CEL}	V _{CE} =V _{SS}	-5.0	-	XC6219/11D, G	0.10	μA	②
					XC6219/11A, B, C, E, F, H			

NOTE: * 1: V_{OUT(T)} = Specified output voltage

* 2: V_{OUT(E)} = Effective output voltage

(I.e. the output voltage when "V_{OUT(T)}+1.0V" is provided at the V_{IN} pin while maintaining a certain I_{OUT} value.)

* 3: V_{dif}={V_{IN1}^(*)-V_{OUT1}^(*)}

* 4: V_{OUT1}=A voltage equal to 98% of the output voltage whenever an amply stabilized I_{OUT} {V_{OUT(T)}+1.0V} is input.

* 5: V_{IN1}=The Input Voltage when V_{OUT1} appears as Input Voltage is gradually decreased.

* 6: Unless otherwise stated, V_{IN}=V_{OUT(T)}+1.0V.

* 7: Input conditions of current limit when 0.9V ≤ V_{OUT(T)} ≤ 1.75V is V_{IN}=V_{OUT(T)}+2.0V

* 8: The rated value when V_{OUT(T)} ≤ 1.5V is V_{OUT(T)} ± 30mV

ELECTRICAL CHARACTERISTICS (Continued)

● Maximum Output Current, Input Voltage Chart

XC6219/6211A~D series

SYMBOL	E-1	E-2
CONDITION, RATINGS	INPUT VOLTAGE (V)	MAX. OUTPUT CURRENT (mA)
SETTING VOLTAGE (V)	V _{IN}	I _{OUTMAX} (MIN.)
V _{OUT(T)} < 1.75V	V _{OUT(T)} + 2.0V	150
V _{OUT(T)} ≥ 1.8V	V _{OUT(T)} + 1.0V	240

XC6219/6211E~H series

SYMBOL	E-1	E-2
CONDITION, RATINGS	INPUT VOLTAGE (V)	MAX. OUTPUT CURRENT (mA)
SETTING VOLTAGE (V)	V _{IN}	I _{OUTMAX} (MIN.)
0.90 ~ 1.05	2.5	260
1.10 ~ 1.15	2.6	270
1.20 ~ 1.25	2.7	290
1.30 ~ 1.35	2.8	300
1.40 ~ 1.45	2.9	
1.50 ~ 1.95	3.0	
2.00 ~ 6.00	V _{OUT(T)} + 1.0V	

● Dropout Voltage Chart

SYMBOL	E-3			E-4		
	V _{dif1}			V _{dif2}		
PARAMETER	MIN.	TYP.	MAX.	MIN.	TYP.	MAX.
OUTPUT VOLTAGE						
0.9	1100	1100	1110	1100	1150	1200
1.50	500	500	510	500	550	600
1.80 ~ 1.85	200	200	210	200	300	400
1.90 ~ 1.95	100	120	150	100	280	380
2.00 ~ 2.05	-	80	120	-	240	350
2.10 ~ 2.25	-	80	120	-	240	330
2.30 ~ 2.45	-	80	120	-	240	310
2.50 ~ 2.75	-	70	100	-	220	290
2.80 ~ 2.95	-	70	100	-	220	270
3.00 ~ 3.05	-	60	90	-	200	270
3.10 ~ 3.95	-	60	90	-	200	250
4.00 ~ 4.95	-	60	80	-	180	230
5.00	-	50	70	-	160	210

* The input voltage 2.0V (MIN.) is needed to operate the IC series.

When the output voltage is less than 2.0V, 2.0V-V_{OUT(T)} of dropout voltage is needed at minimum.

TEST CIRCUITS

Circuit ①

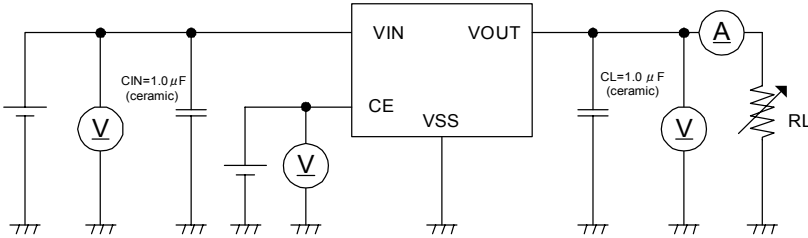

Circuit ②

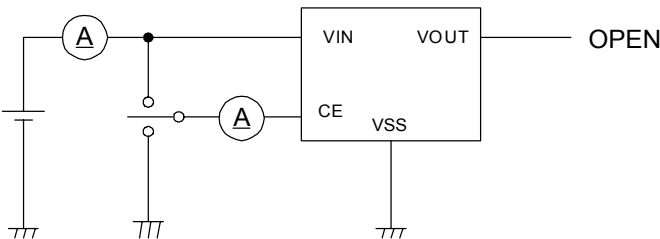

Circuit ③

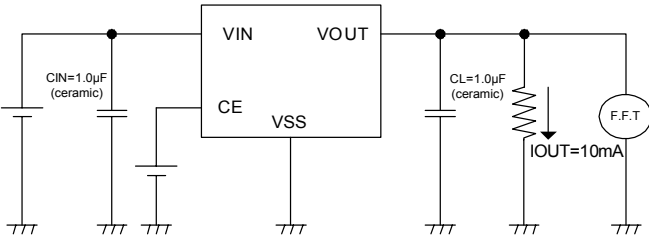

Circuit ④

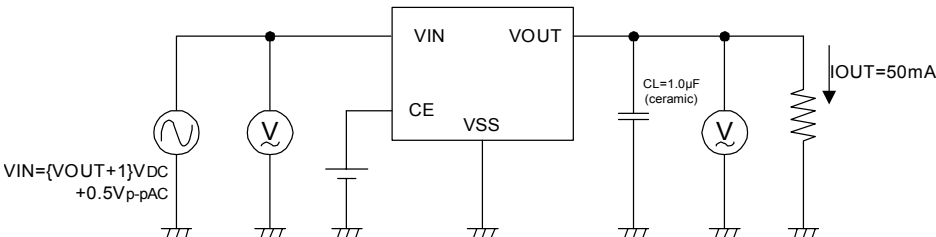

Downloaded from Elcodis.com electronic components distributor

OPERATIONAL EXPLANATION

<Output Voltage Control>

The voltage divided by resistors R1 & R2 is compared with the internal reference voltage by the error amplifier. The P-channel MOSFET, which is connected to the V_{OUT} pin, is then driven by the subsequent output signal. The output voltage at the V_{OUT} pin is controlled and stabilized by a system of negative feedback. The current limit circuit and short protect circuit operate in relation to the level of output current. Further, the IC's internal circuitry can be shutdown via the CE pin's signal

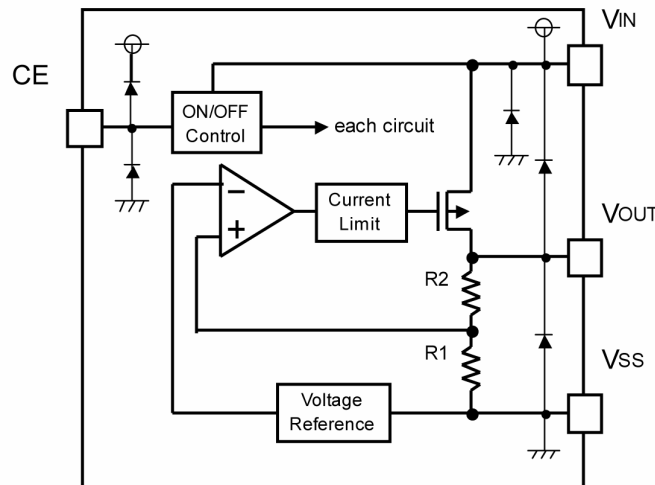

<Low ESR Capacitors>

With the XC6209/6212 series, a stable output voltage is achievable even if used with low ESR capacitors as a phase compensation circuit is built-in. In order to ensure the effectiveness of the phase compensation, we suggest that an output capacitor (C_L) is connected as close as possible to the output pin (V_{OUT}) and the V_{SS} pin. Please use an output capacitor with a capacitance value of at least 1 μ F. Also, please connect an input capacitor (C_{IN}) of 0.1 μ F between the V_{IN} pin and the V_{SS} pin in order to ensure a stable power input.

Stable phase compensation may not be ensured if the capacitor runs out capacitance when depending on bias and temperature. In case the capacitor depends on the bias and temperature, please make sure the capacitor can ensure the actual capacitance.

<Current Limiter, Short-Circuit Protection>

The XC6219/6211 series includes a combination of a fixed current limiter circuit & a foldback circuit, which aid the operations of the current limiter and circuit protection. When the load current reaches the current limit level, the fixed current limiter circuit operates and output voltage drops. As a result of this drop in output voltage, the foldback circuit operates, output voltage drops further and output current decreases. When the output pin is shorted, a current of about 50mA flows.

<CE Pin>

The IC's internal circuitry can be shutdown via the signal from the CE pin with the XC6219/6211 series. In shutdown mode, output at the V_{OUT} pin will be pulled down to the V_{SS} level via R1 & R2. The operational logic of the IC's CE pin is selectable (please refer to the selection guide). Note that as the standard XC6219/6211B type's regulator 1 and 2 are both 'High Active/No Pull-Down', operations will become unstable with the CE pin open. Although the CE pin is equal to an inverter input with CMOS hysteresis, with either the pull-up or pull-down options, the CE pin input current will increase when the IC is in operation. We suggest that you use this IC with either a V_{IN} voltage or a V_{SS} voltage input at the CE pin. If this IC is used with the correct specifications for the CE pin, the operational logic is fixed and the IC will operate normally. However, supply current may increase as a result of through current in the IC's internal circuitry.

NOTES ON USE

1. Please use this IC within the stated absolute maximum ratings. The IC is liable to malfunction should the ratings be exceeded.
2. Where wiring impedance is high, operations may become unstable due to noise and/or phase lag depending on output current. Please keep the resistance low between V_{IN} and V_{SS} wiring in particular.
3. Please wire the input capacitor (C_{IN}) and the output capacitor (C_L) as close to the IC as possible.

■ TYPICAL PERFORMANCE CHARACTERISTICS

(1) Output Voltage vs. Output Current

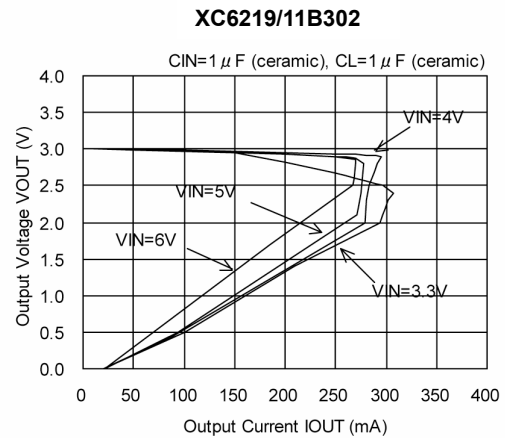
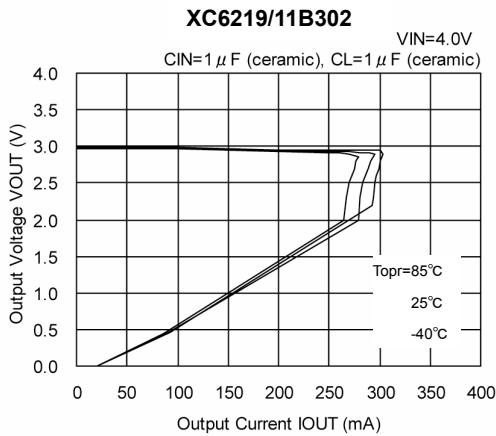
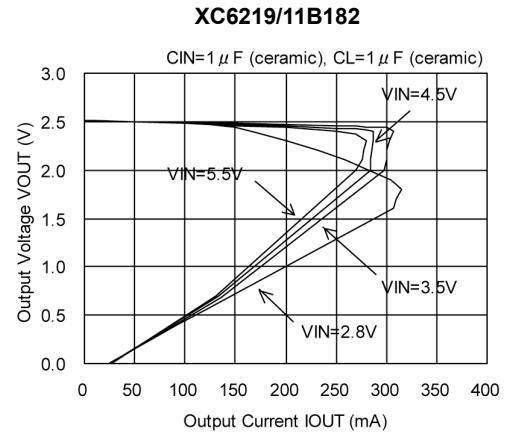
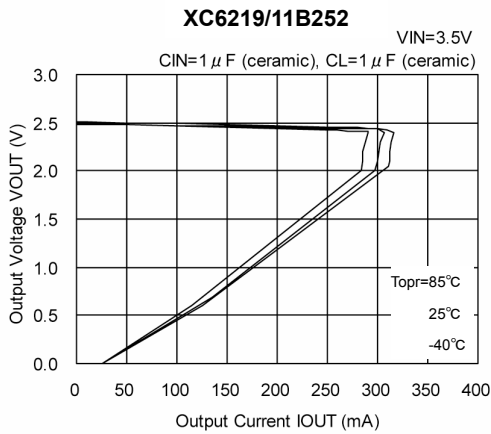
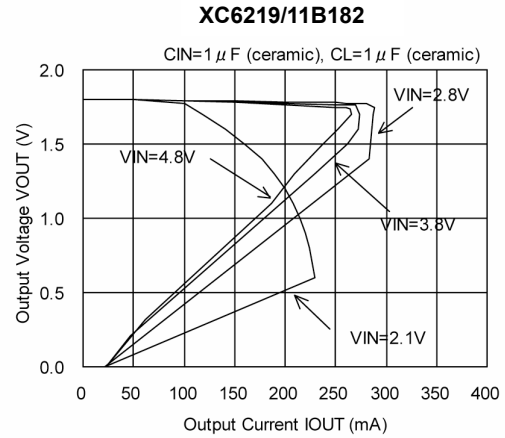
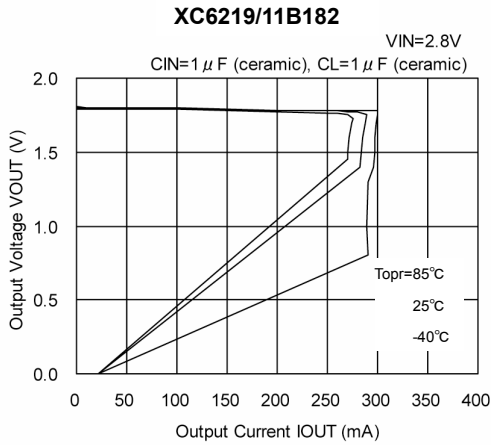

TYPICAL PERFORMANCE CHARACTERISTICS (Continued)

(2) Output Voltage vs. Input Voltage

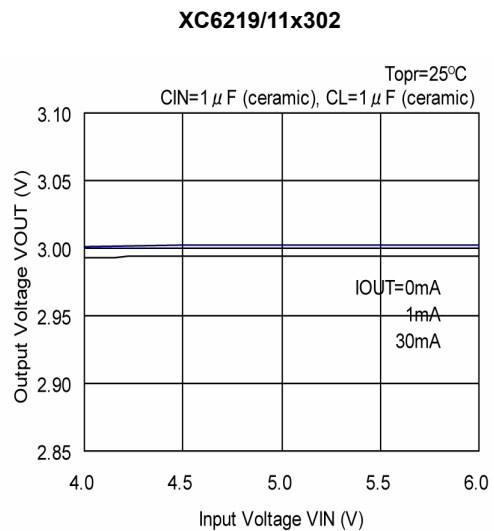
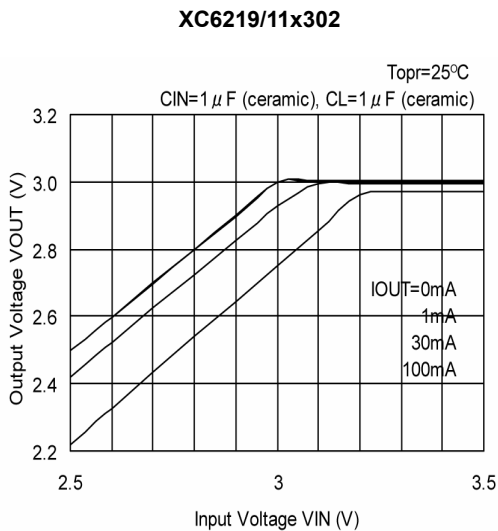
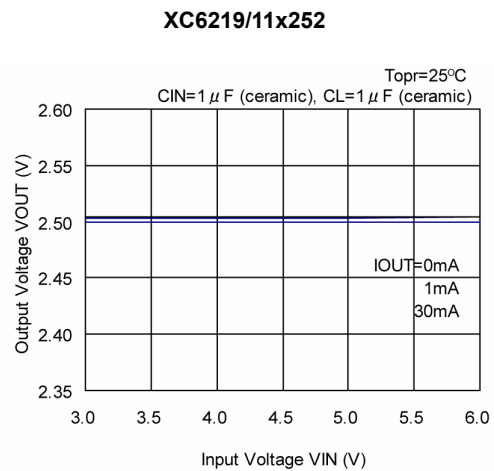
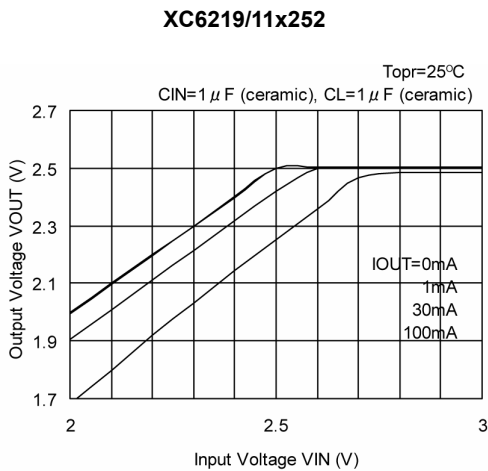
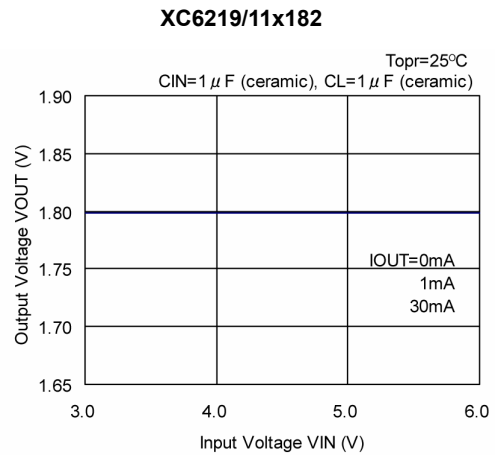
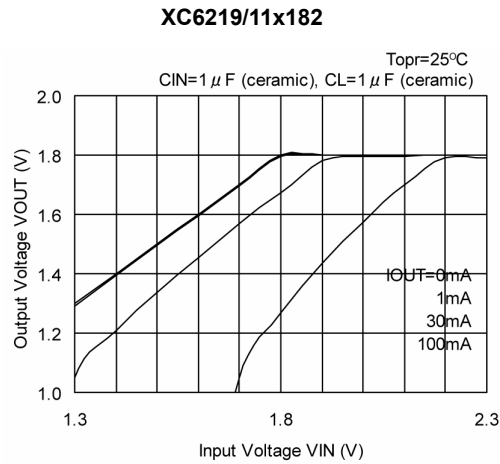

TYPICAL PERFORMANCE CHARACTERISTICS (Continued)

(3) Dropout Voltage vs. Output Current

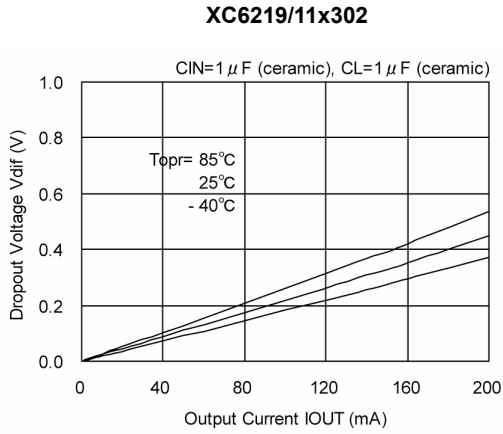
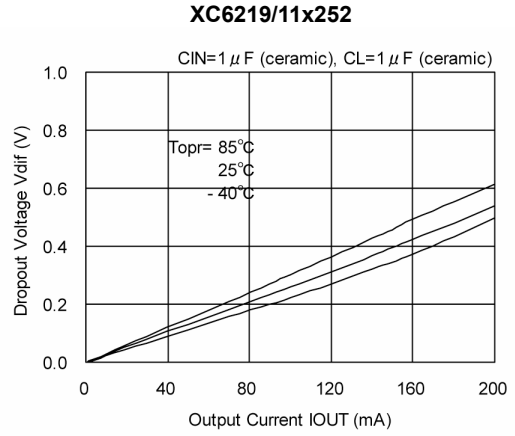
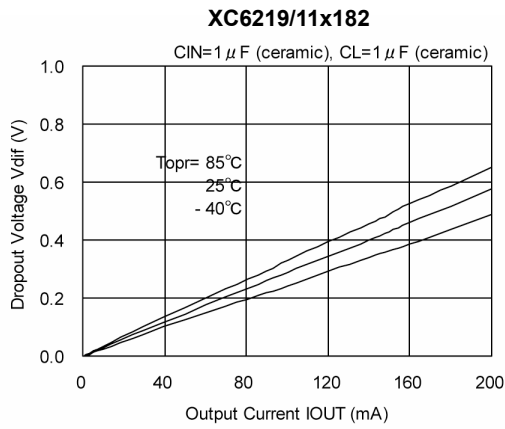

(4) Supply Current vs. Input Voltage

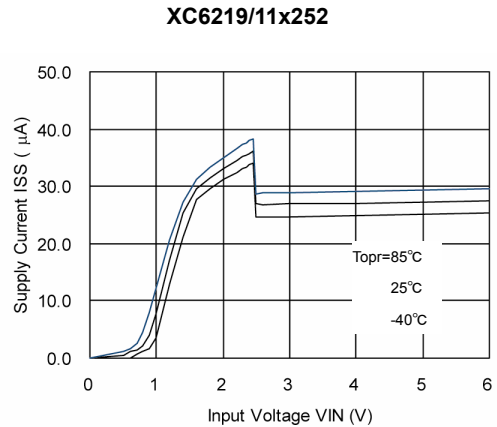
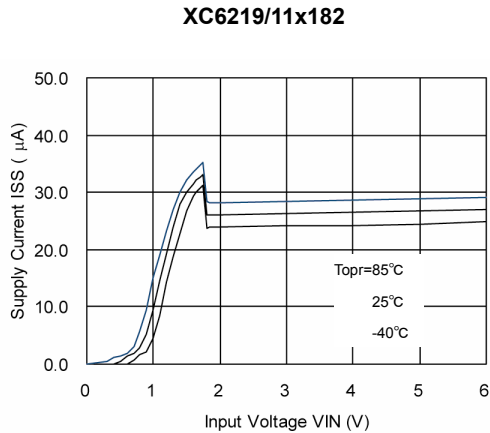

TYPICAL PERFORMANCE CHARACTERISTICS (Continued)

(4) Supply Current vs. Input Voltage (Continued)

XC6219/11x302

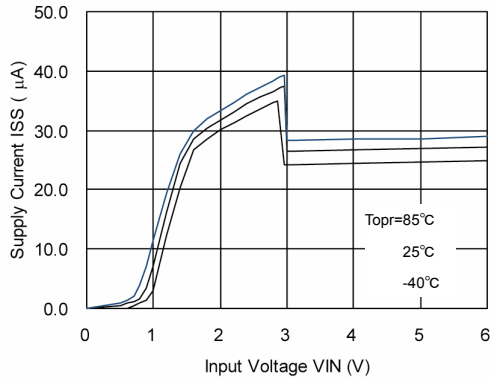

(5) Output Voltage vs. Ambient Temperature

XC6219/11x182

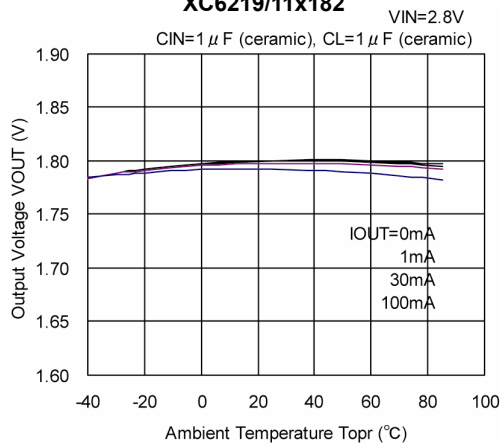

XC6219/11x252

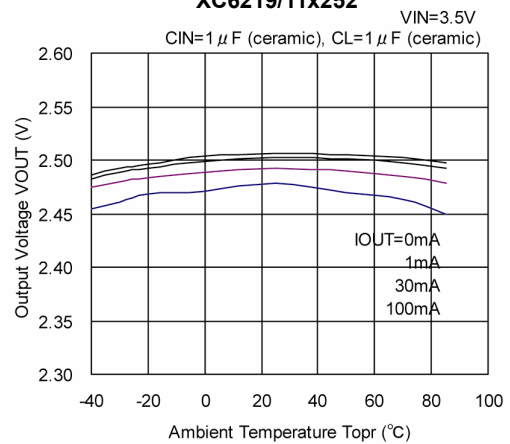

XC6219/11x302

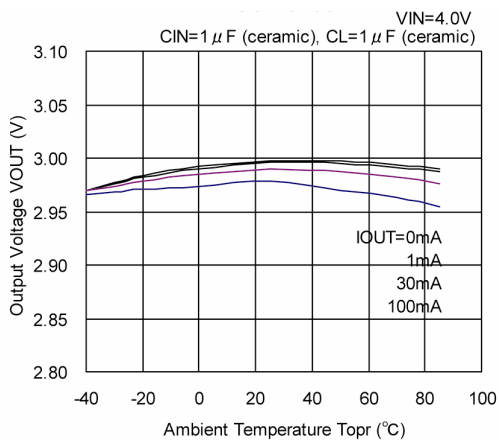

■ TYPICAL PERFORMANCE CHARACTERISTICS (Continued)

(6) Supply Current vs. Ambient Temperature

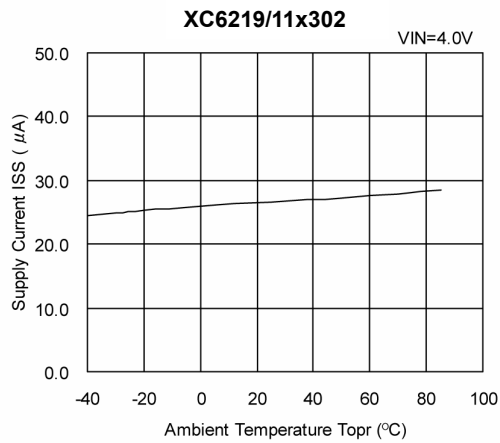
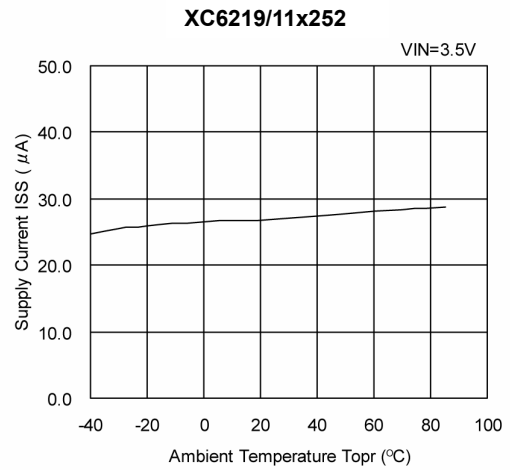
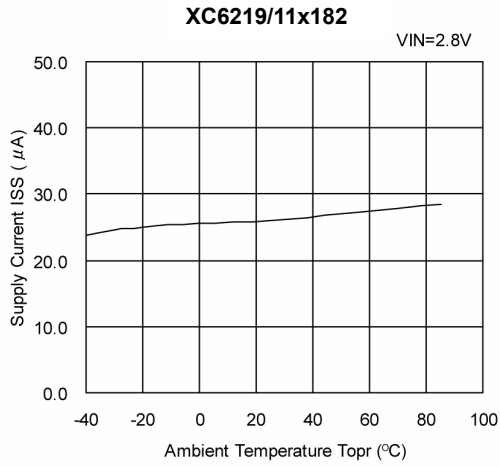

TYPICAL PERFORMANCE CHARACTERISTICS (Continued)

(7) Input Transient Response

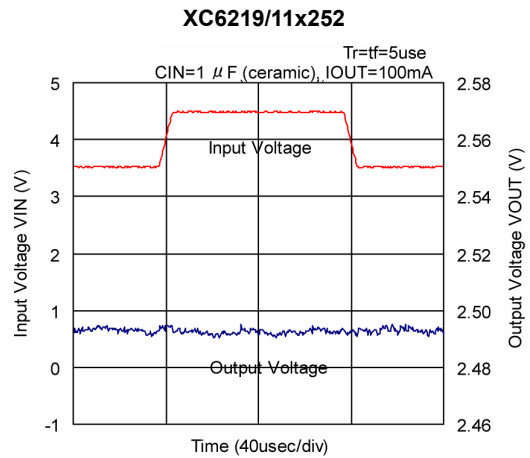
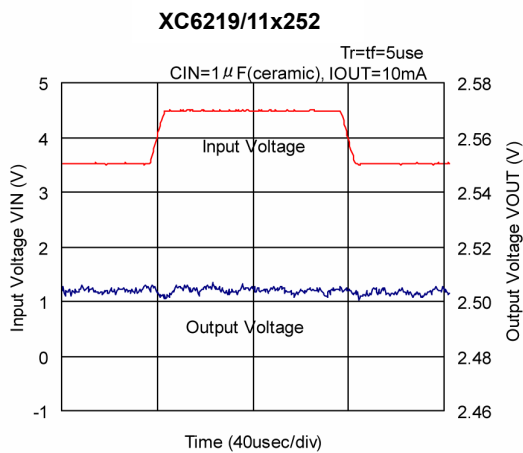
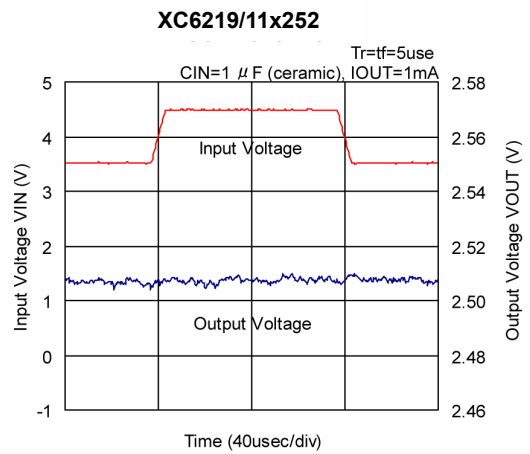
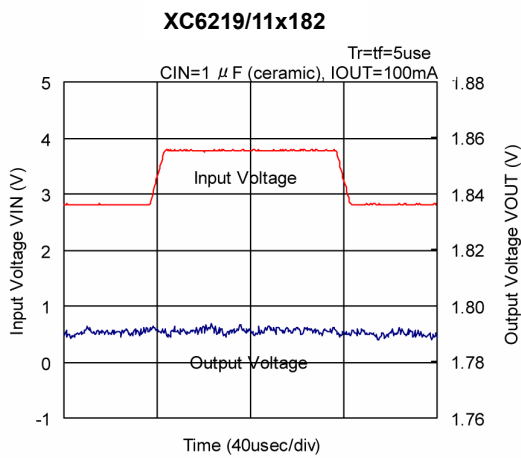
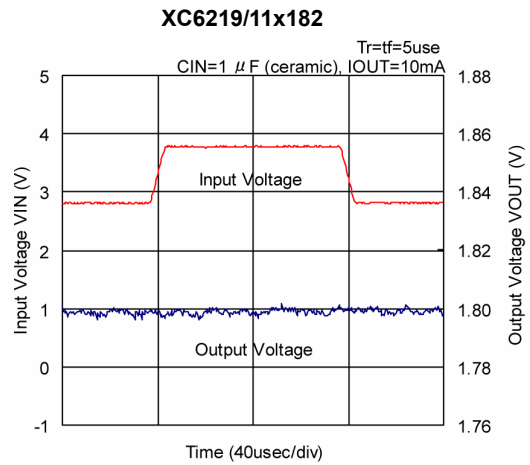
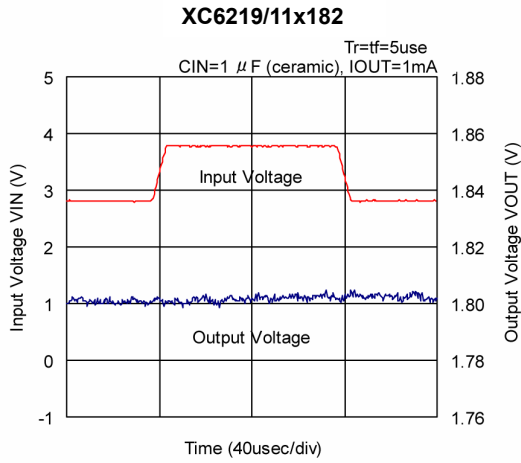

■ TYPICAL PERFORMANCE CHARACTERISTICS (Continued)

(7) Input Transient Response (Continued)

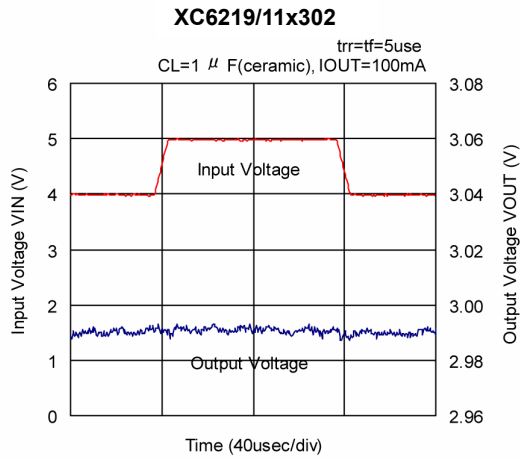
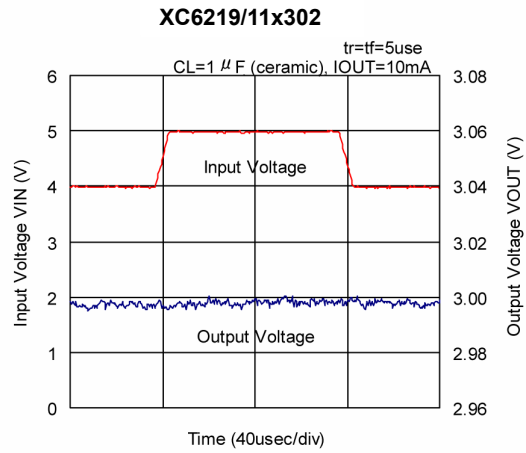
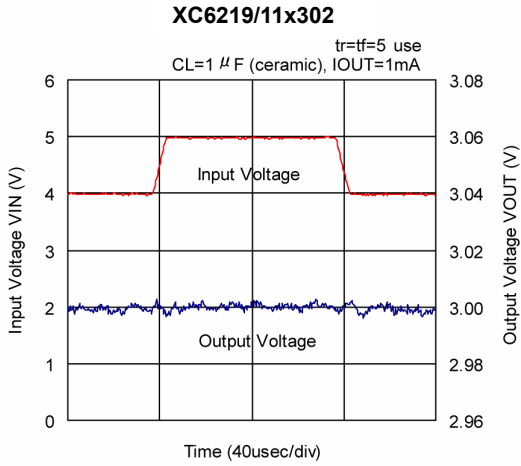

(8) Load Transient Response

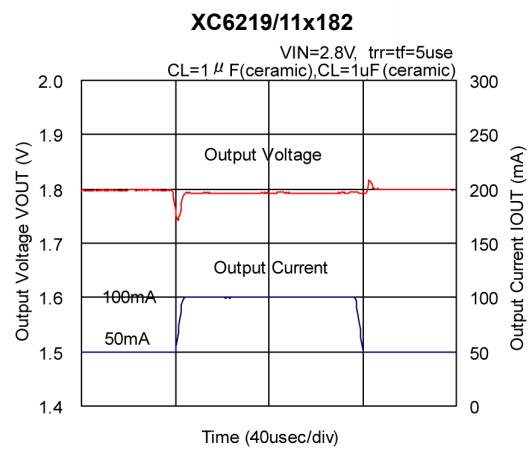
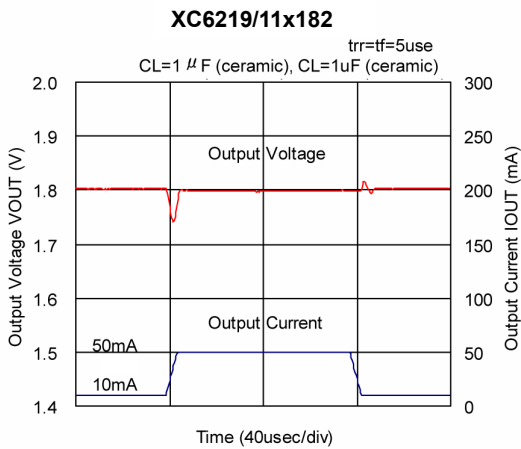

TYPICAL PERFORMANCE CHARACTERISTICS (Continued)

(8) Load Transient Response (Continued)

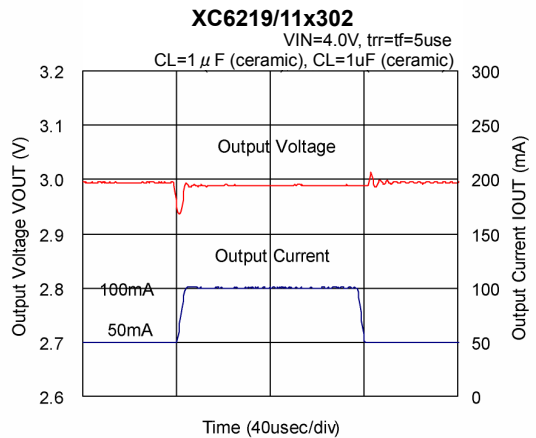
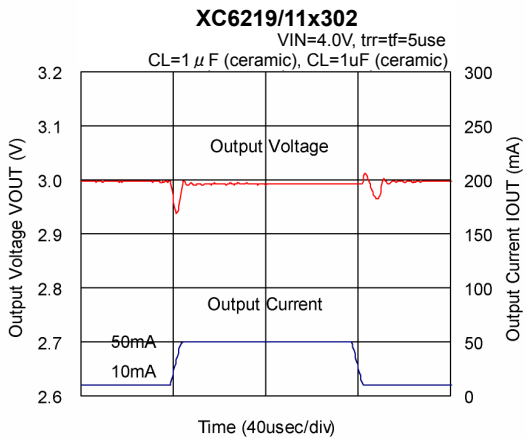
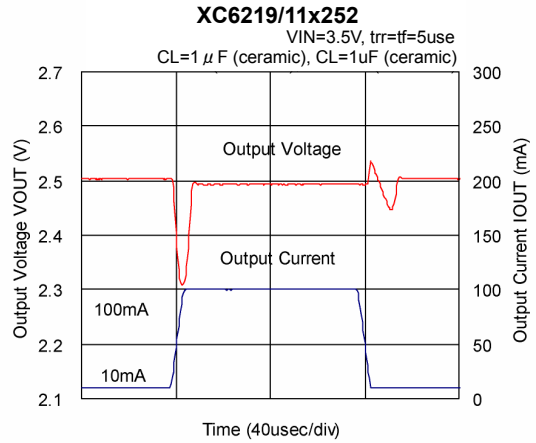
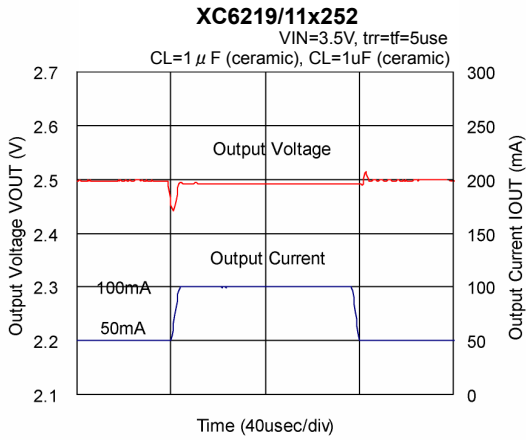
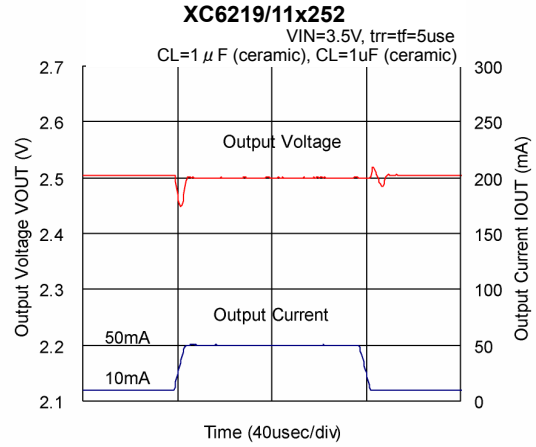
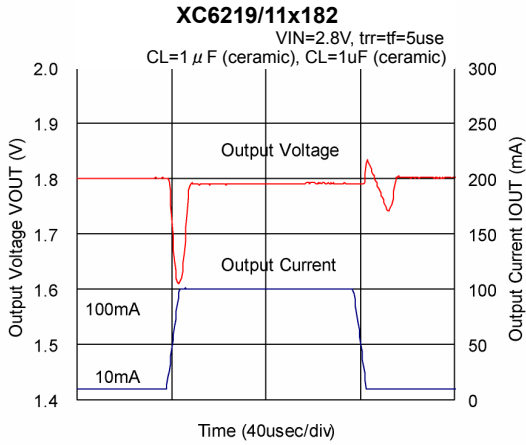

■ TYPICAL PERFORMANCE CHARACTERISTICS (Continued)

(8) Load Transient Response (Continued)

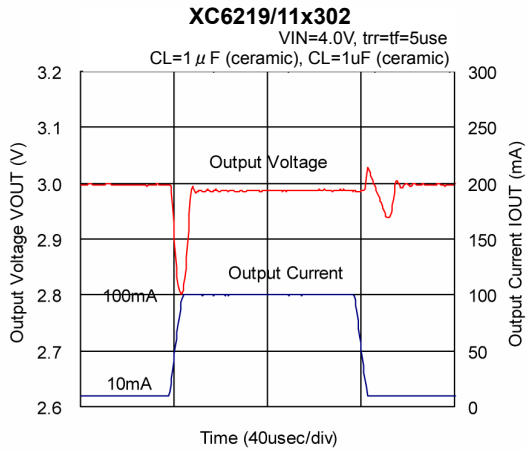

(9) Ripple Rejection Rate

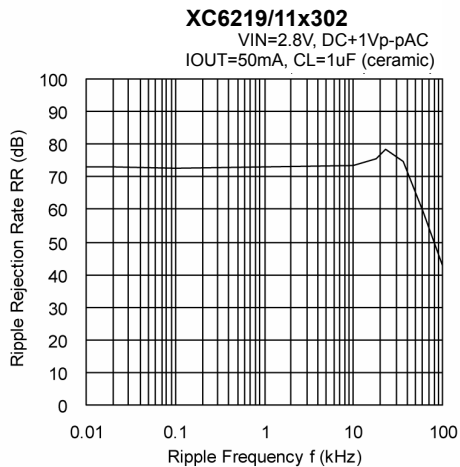
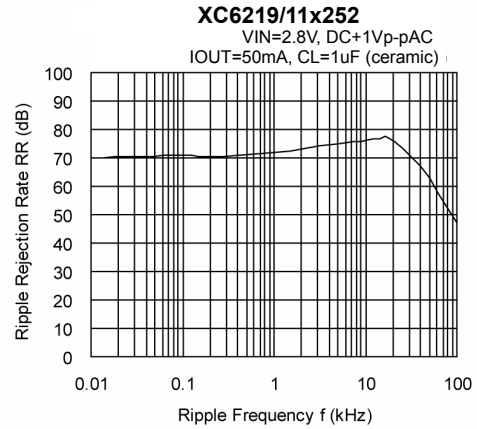
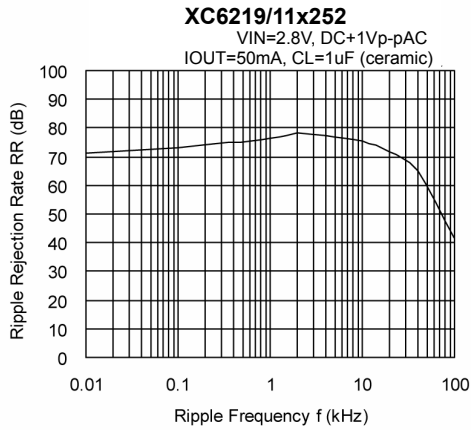

XC6219/6211 Series

PACKAGING INFORMATION

● SOT-25 (SOT-23-5)

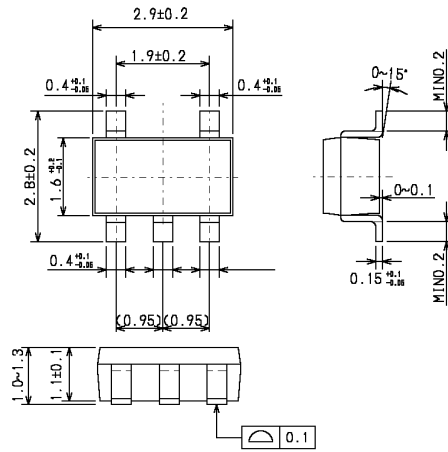

● SOT-89-5

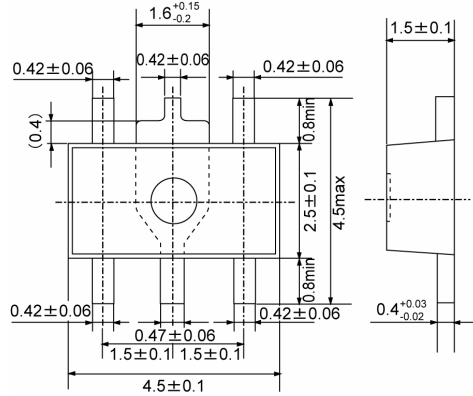

● USP-6B

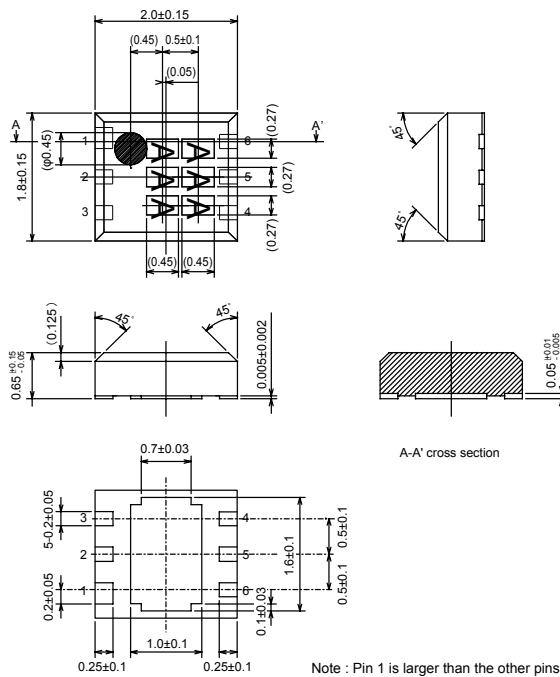

RECOMMENDED MOUNT PATTERN

● USP-6B

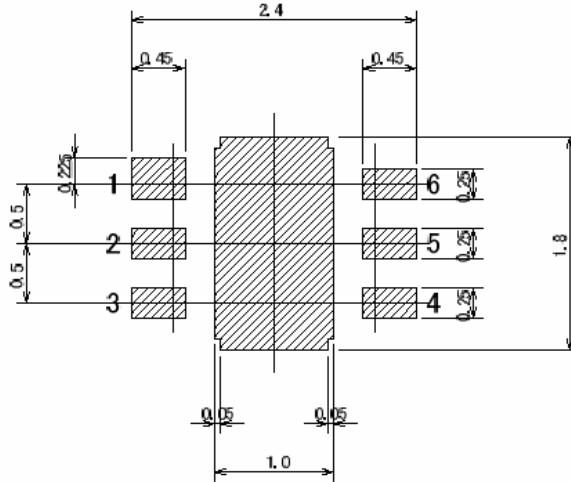

RECOMMENDED METAL MASK DESIGN

● USP-6B

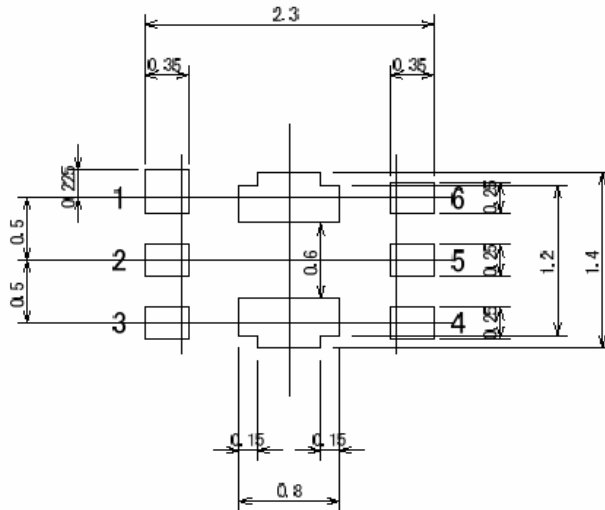

MARKING RULE

[XC6219 Series]

- SOT-25 (SOT-23-5), SOT-89-5

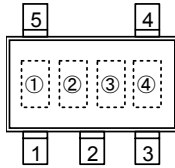

SOT-25
(TOP VIEW)

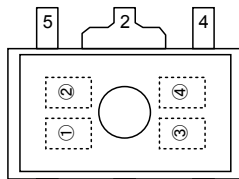

SOT-89-5
(TOP VIEW)

① Represents product series

MARK	PRODUCT SERIES
L	XC6219xxxxxx

② Represents type of regulator

MARK				PRODUCT SERIES
V _{OUT} 100mV INCREMENTS		V _{OUT} 50mV INCREMENTS		
V _{OUT} :0.1~3.0V	V _{OUT} :3.1~6.0V	V _{OUT} :0.15~3.05V	V _{OUT} :3.15~6.05V	
V	A	E	L	XC6219Axxxxx
X	B	F	M	XC6219Bxxxxx
Y	C	H	N	XC6219Cxxxxx
Z	D	K	P	XC6219Dxxxxx

③ Represents output voltage

MARK	OUTPUT VOLTAGE (V)				MARK	OUTPUT VOLTAGE (V)			
0	-	3.1	-	3.15	F	1.6	4.6	1.65	4.65
1	-	3.2	-	3.25	H	1.7	4.7	1.75	4.75
2	-	3.3	-	3.35	K	1.8	4.8	1.85	4.85
3	-	3.4	-	3.45	L	1.9	4.9	1.95	4.95
4	-	3.5	-	3.55	M	2.0	5.0	2.05	-
5	-	3.6	-	3.65	N	2.1	-	2.15	-
6	-	3.7	-	3.75	P	2.2	-	2.25	-
7	-	3.8	-	3.85	R	2.3	-	2.35	-
8	0.9	3.9	0.95	3.95	S	2.4	-	2.45	-
9	1.0	4.0	1.05	4.05	T	2.5	-	2.55	-
A	1.1	4.1	1.15	4.15	U	2.6	-	2.65	-
B	1.2	4.2	1.25	4.25	V	2.7	-	2.75	-
C	1.3	4.3	1.35	4.35	X	2.8	-	2.85	-
D	1.4	4.4	1.45	4.45	Y	2.9	-	2.95	-
E	1.5	4.5	1.55	4.55	Z	3.0	-	3.05	-

④ Represents production lot number

0 to 9, A to Z reverse character of 0 to 9, A to Z repeated (G, I, J, O, Q, W excepted)

MARKING RULE (Continued)

● USP-6B

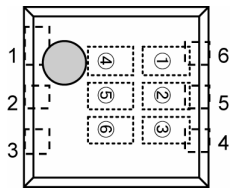

USP-6B
(TOP VIEW)

①② Represents product series

MARK		PRODUCT SERIES
①	②	
1	9	XC6219xxxxDx

③ Represents type of regulator

MARK	TYPE	PRODUCT SERIES
A	High Active, pull-down resistor built-in (semi-custom)	XC6219AxxxMx
B	High Active, no pull-down resistor built-in (semi-custom)	XC6219BxxxMx
C	Low Active, pull-up resistor built-in (semi-custom)	XC6219CxxxMx
D	Low Active, no pull-up resistor built-in (semi-custom)	XC6219DxxxMx

④ Represents product series

MARK	VOLTAGE (V)	PRODUCT SERIES
3	3.X	XC6219x3xxDx
5	5.X	XC6219x5xxDx

⑤ Represents output voltage

MARK	VOLTAGE	PRODUCT SERIES	SYMBOL	VOLTAGE	PRODUCT SERIES
0	X.0	XC6219xx0xDx	A	X.05	XC6219xx0ADx
1	X.1	XC6219xx1xDx	B	X.15	XC6219xx1ADx
2	X.2	XC6219xx2xDx	C	X.25	XC6219xx2ADx
3	X.3	XC6219xx3xDx	D	X.35	XC6219xx3ADx
4	X.4	XC6219xx4xDx	E	X.45	XC6219xx4ADx
5	X.5	XC6219xx5xDx	F	X.55	XC6219xx5ADx
6	X.6	XC6219xx6xDx	H	X.65	XC6219xx6ADx
7	X.7	XC6219xx7xDx	K	X.75	XC6219xx7ADx
8	X.8	XC6219xx8xDx	L	X.85	XC6219xx8ADx
9	X.9	XC6219xx9xDx	M	X.95	XC6219xx9ADx

⑥ Represents production lot number

0 to 9, A to Z repeated (G, I, J, O, Q, W excepted)

* No character inversion used.

MARKING RULE (Continued)

[XC6211 Series]

● SOT-25(SOT-23-5)

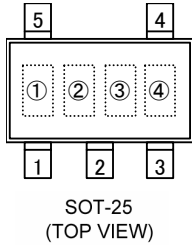

① Represents product series

MARK	PRODUCT SERIES
A	XC6211xxxxMx

② Represents type of regulator

MARK				PRODUCT SERIES
V _{OUT} 100mV INCREMENTS		V _{OUT} 50mV INCREMENTS		
V _{OUT} :0.1~3.0V	V _{OUT} :3.1~6.0V	V _{OUT} :0.15~3.05V	V _{OUT} :3.15~6.05V	
V	A	E	L	XC6211AxxxMx
X	B	F	M	XC6211BxxxMx
Y	C	H	N	XC6211CxxxMx
Z	D	K	P	XC6211DxxxMx

③ Represents output voltage

MARK	OUTPUT VOLTAGE (V)				MARK	OUTPUT VOLTAGE (V)			
0	-	3.1	-	3.15	F	1.6	4.6	1.65	4.65
1	-	3.2	-	3.25	H	1.7	4.7	1.75	4.75
2	-	3.3	-	3.35	K	1.8	4.8	1.85	4.85
3	-	3.4	-	3.45	L	1.9	4.9	1.95	4.95
4	-	3.5	-	3.55	M	2.0	5.0	2.05	5.05
5	-	3.6	-	3.65	N	2.1	5.1	2.15	5.15
6	-	3.7	-	3.75	P	2.2	5.2	2.25	5.25
7	-	3.8	-	3.85	R	2.3	5.3	2.35	5.35
8	-	3.9	-	3.95	S	2.4	5.4	2.45	5.45
9	-	4.0	-	4.05	T	2.5	5.5	2.55	5.55
A	-	4.1	-	4.15	U	2.6	5.6	2.65	5.65
B	-	4.2	-	4.25	V	2.7	5.7	2.75	5.75
C	-	4.3	-	4.35	X	2.8	5.8	2.85	5.85
D	-	4.4	-	4.45	Y	2.9	5.9	2.95	5.95
E	-	4.5	-	4.55	Z	3.0	6.0	3.05	6.05

④ Represents production lot number

0 to 9, A to Z reverse character of 0 to 9, A to Z repeated (G, I, J, O, Q, W excepted)

1. The products and product specifications contained herein are subject to change without notice to improve performance characteristics. Consult us, or our representatives before use, to confirm that the information in this catalog is up to date.
2. We assume no responsibility for any infringement of patents, patent rights, or other rights arising from the use of any information and circuitry in this catalog.
3. Please ensure suitable shipping controls (including fail-safe designs and aging protection) are in force for equipment employing products listed in this catalog.
4. The products in this catalog are not developed, designed, or approved for use with such equipment whose failure or malfunction can be reasonably expected to directly endanger the life of, or cause significant injury to, the user.
(e.g. Atomic energy; aerospace; transport; combustion and associated safety equipment thereof.)
5. Please use the products listed in this catalog within the specified ranges.
Should you wish to use the products under conditions exceeding the specifications, please consult us or our representatives.
6. We assume no responsibility for damage or loss due to abnormal use.
7. All rights reserved. No part of this catalog may be copied or reproduced without the prior permission of Torex Semiconductor Ltd.

TOREX SEMICONDUCTOR LTD.