

HIGH TEMPERATURE QUAD OPERATIONAL AMPLIFIER

HT1104

FEATURES

- Specified Over -55 to +225°C
- Single or Split Supply Operation
- Common-Mode Input Voltage Range Includes Negative Rail
- Low Input Bias and Offset Parameters
- Input/Output Overload Protection
- ESD Protection Circuitry
- Latchup Free Design with Dielectric Isolation
- Hermetic 14-Lead Ceramic DIP

APPLICATIONS

- Down-Hole Oil Well
- Turbine Engine Control
- Avionics
- Industrial Process Control
- Nuclear Reactor
- Electric Power Conversion
- Heavy Duty Internal Combustion Engines

GENERAL DESCRIPTION

The HT1104 monolithic quad operational amplifier is a versatile performer over an extremely wide temperature range. It is fabricated with Honeywell's dielectrically isolated high-temperature linear (HTMOS™) process, and is designed specifically for use in systems operating in severe high-temperature environments. All parts are burned in at 250°C to eliminate infant mortality.

These amplifiers provide guaranteed performance over the full -55 to +225°C temperature range. Typically, parts will operate up to +300°C for a year, with derated performance. The HT1104 will operate with both single and split supplies. High-temperature applications such as transducer interfacing, amplification, active filtering, and signal buffering are all possible with the HT1104.

PACKAGE PINOUT

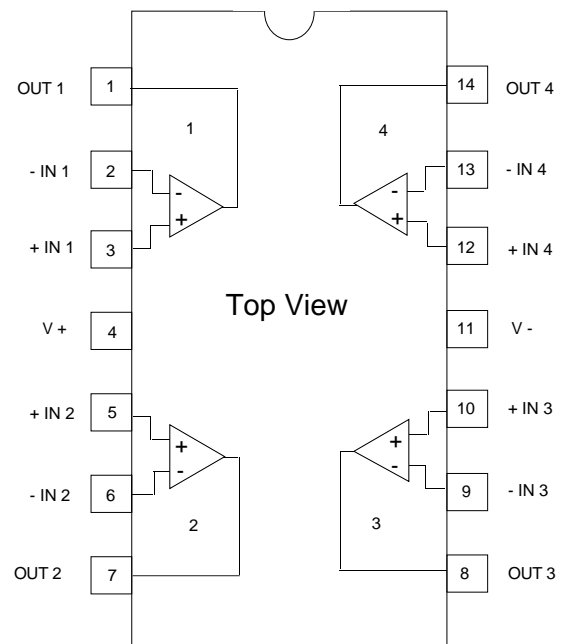

14-Lead CerDip
 $\theta_{jc} = 7^{\circ}\text{C/W}$

HT1104

SIMPLIFIED SCHEMATIC (each amplifier)

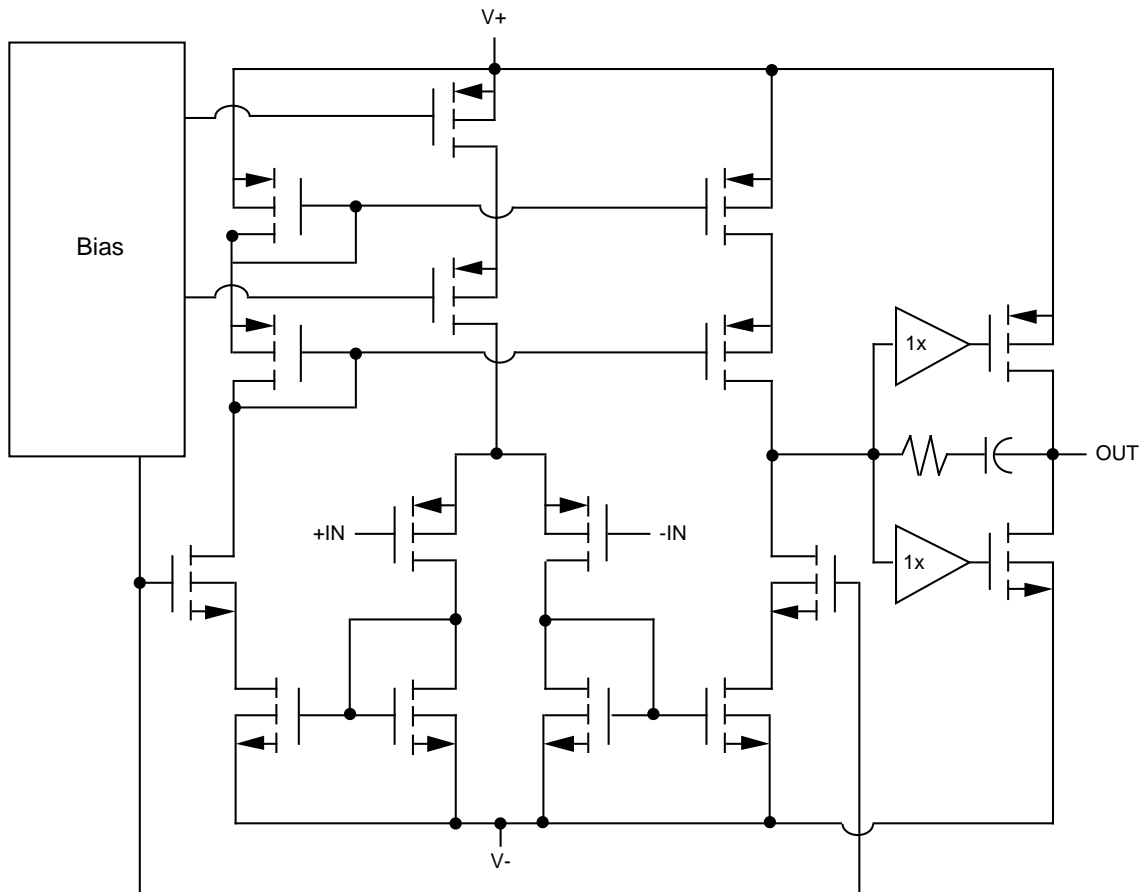

PACKAGE DETAIL

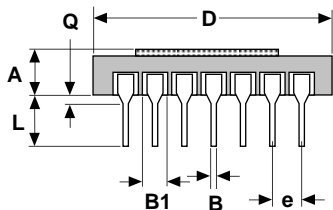

A	0.150 (max)
B	0.018 ± 0.002
C	0.010 ± 0.002
D	0.700 ± 0.010
E	0.295 REF

E1	0.300 ± 0.010
B1	0.047 ± 0.002
e	0.100 ± 0.005
L	0.125 to 0.180
Q	0.035 ± 0.010

All dimensions in inches
Leads are Gold Plated Nickel

ABSOLUTE MAXIMUM RATINGS (1)

Total Supply Voltage (V+ to V-)	13 V
Input Voltage	- 0.5 to V _{DD} +0.5 V
Output Short Circuit Duration	Continuous
Input Current (each input)	±5 mA
Output Current (each output)	±50 mA
Storage Temperature	-65 to +325°C
Lead Temperature (attachment, 10 sec)	355°C

(1) Stresses in excess of those listed above may result in permanent damage. These are stress ratings only, and operation at these levels is not implied. Frequent or extended exposure to absolute maximum conditions may effect device reliability.

ORDERING INFORMATION

HT1104DC

D - Indicates package type
D = Standard DIP
For packaging options, call Honeywell

C - Indicates screening level
C = Commercial
B = High Temperature Class B

ELECTRICAL CHARACTERISTICS

Symbol	Parameter	Conditions (1)	Typ	Min	Max	Units
V_{DD}	Supply Voltage (2)			5.0	11	V
I_{DD}	Supply Current (total package)		2 (25°C)		6.5 (225°C)	mA
V_O	Max. Output Voltage Swing	$V_s \pm 5V, R=10k\Omega, C=20pF$		-4.8	+4.8	V
I_O	Output Short Circuit Current	Sink/Source (3)	15			mA
V_{IO}	Input Offset Voltage	@ 25°C	2			mV
		-55 to +225°C			7	mV
		Drift with Temperature (4)	10		15	$\mu V/^\circ C$
		Drift with Time (4)	100			$\mu V/Year$
N	Noise (4)	$f_o = 10\text{ Hz}$	200			nv/\sqrt{Hz}
		$f_o = 1\text{ kHz}$	30			nv/\sqrt{Hz}
		$f = 0\text{ to }10\text{ Hz}$	8			$\mu V, p-p$
I_{IO}	Input Offset Current	@ 25°C	0.01			nA
		-55 to +225°C	5		10	
I_{IB}	Input Bias Current	@ 25°C	0.01			nA
		-55 to +225°C	10		10	
V_{CM}	Input Voltage Range	$V_s = \pm 5V$		$-V_s$	$+V_s - 2.2$	V
A_{VOL}	Open Loop Gain	$R = 10k\Omega, C = 20pF$	115	100		dB
CMRR	Common Mode Rejection Ratio		95	80		dB
PSRR	Power Supply Rejection Ratio	$\pm V_s$	95	80		dB
SR	Slew Rate (4)	$R = 10k\Omega, C = 20pF, 25^\circ C$	1.4			$V/\mu sec$
UGB	Unity Gain Bandwidth (4)	$R = 10k\Omega, C = 20pF, 25^\circ C$	1.4			MHz
ϕ_M	Phase Margin (4)	$C = 20pF$	60	50		$^\circ$
AM	Gain Margin (4)	$C = 20pF$		8		dB
ESD	ESD Protection (4)			2000		V

(1) Unless otherwise noted, specifications apply for $\pm 5V$ supply from -55 to $+225^\circ C$.

(2) Recommended supplies are $\pm 5V$ or $0-10V$. Contact factory for low-voltage operation specifications.

(3) Rating for a single amplifier of the quad. For steady state biasing conditions, 10mA is the maximum recommended.

(4) These parameters are guaranteed by design and not tested on each device. Human body model, $1.5k\Omega$ in series with $100pF$.

SLEW RATE vs. TEMPERATURE

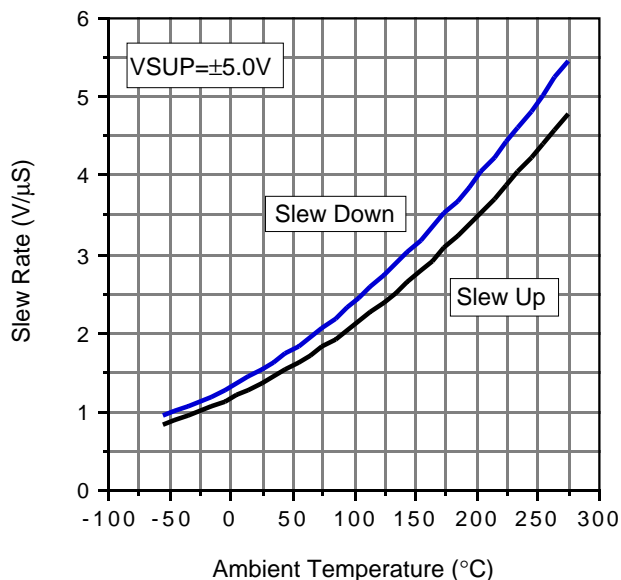

SUPPLY CURRENT vs. TEMPERATURE

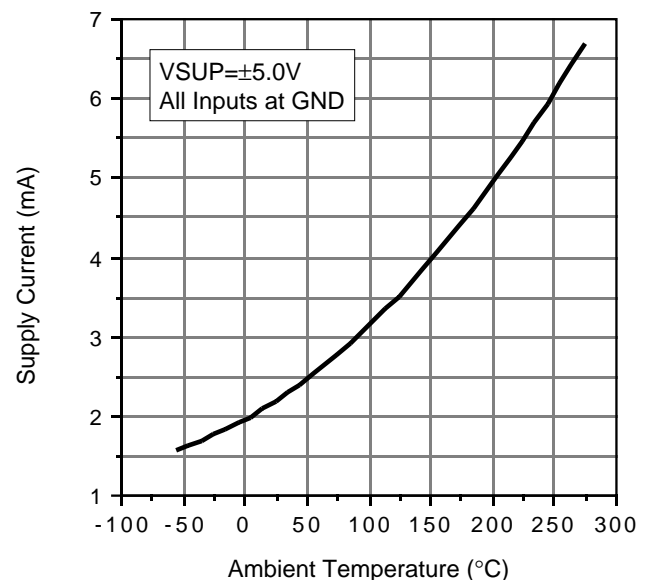

OPEN LOOP GAIN and PHASE vs. FREQUENCY

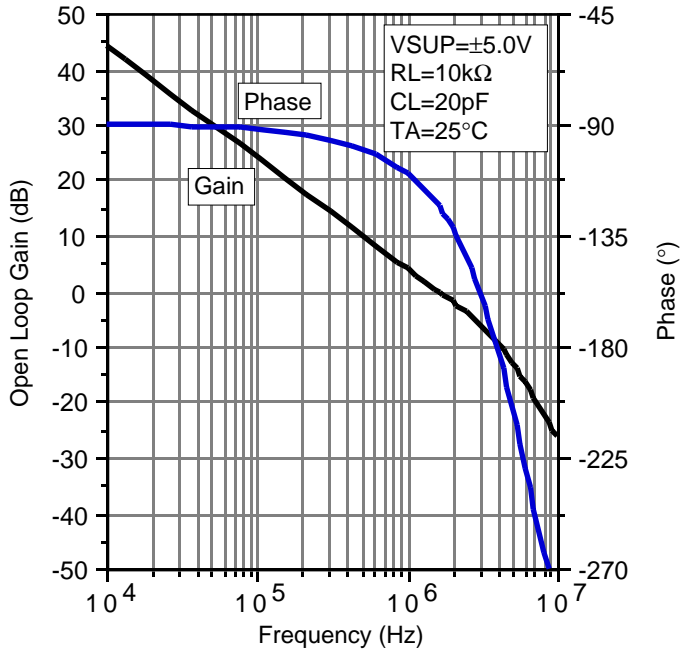

OPEN LOOP GAIN and PHASE vs. FREQUENCY

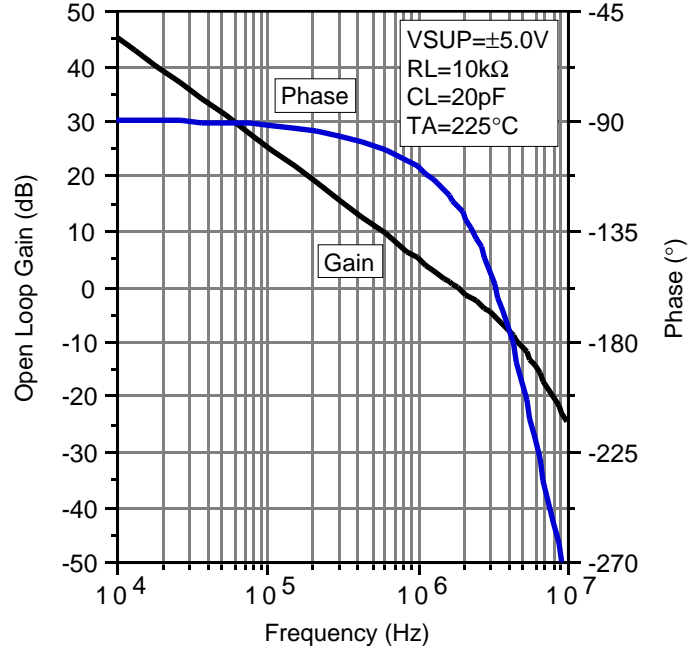

OPEN LOOP GAIN and PHASE vs. FREQUENCY

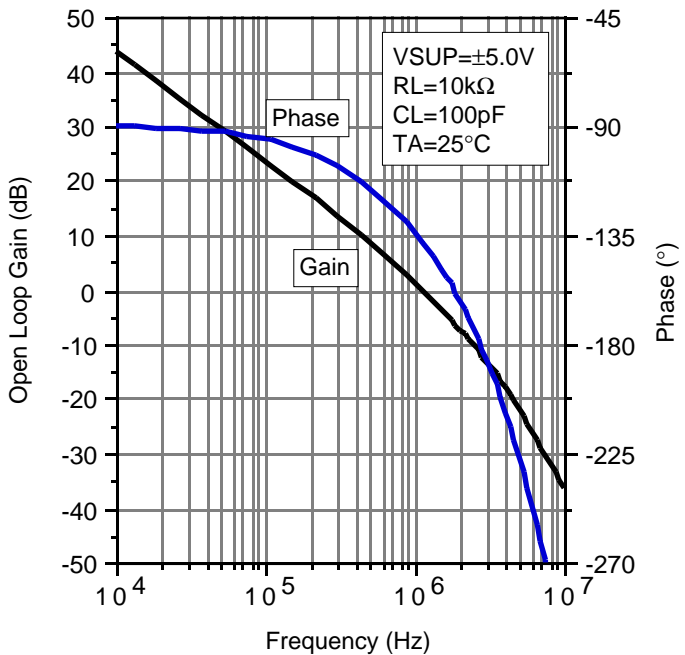

OPEN LOOP GAIN and PHASE vs. FREQUENCY

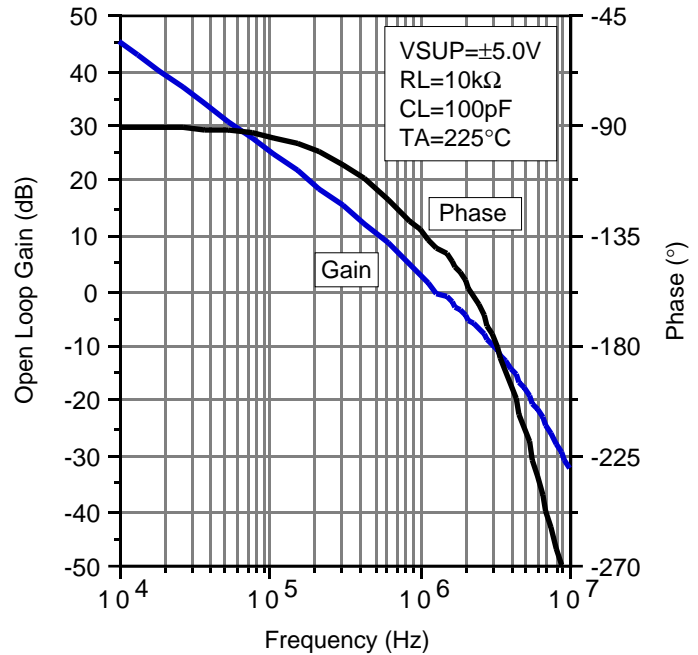

OPEN LOOP GAIN and PHASE vs. FREQUENCY

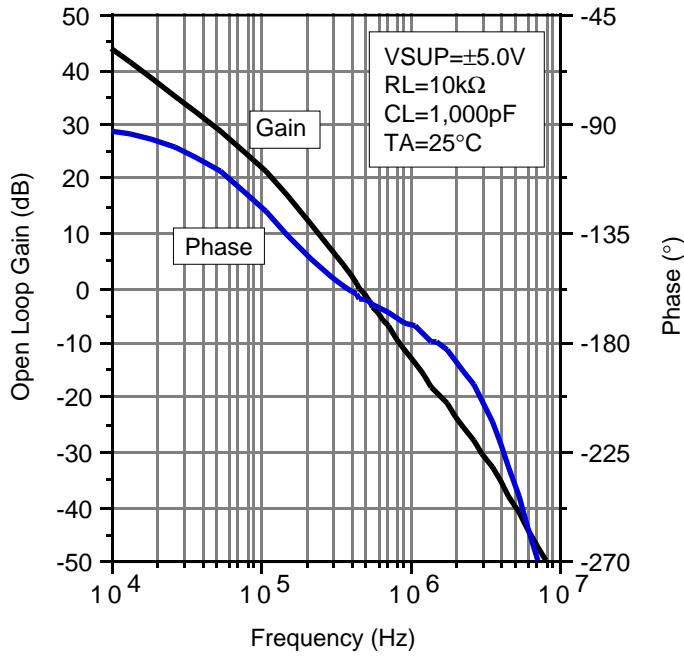

OPEN LOOP GAIN and PHASE vs. FREQUENCY

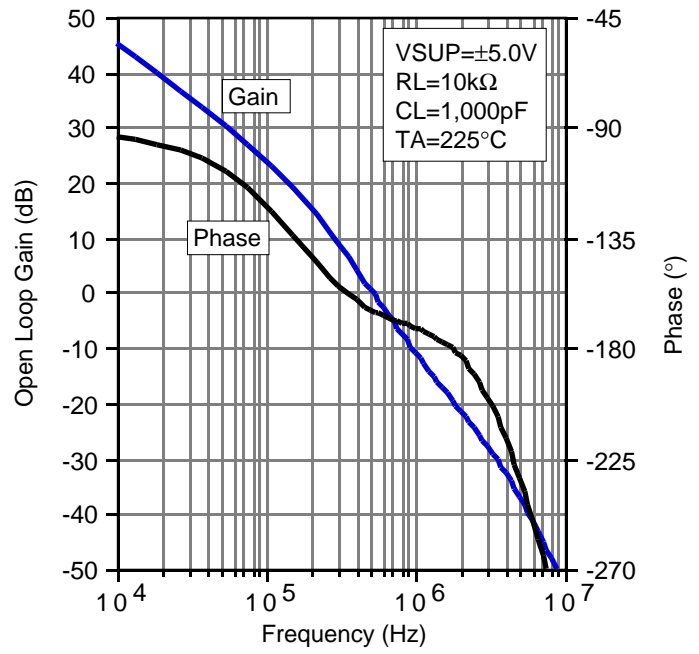

COMMON MODE REJECTION RATIO vs. FREQUENCY

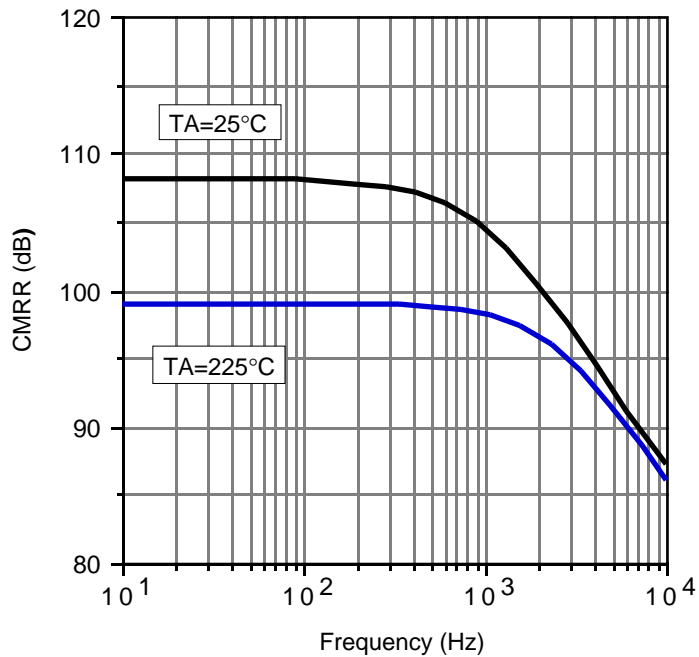

OPEN LOOP GAIN vs. FREQUENCY

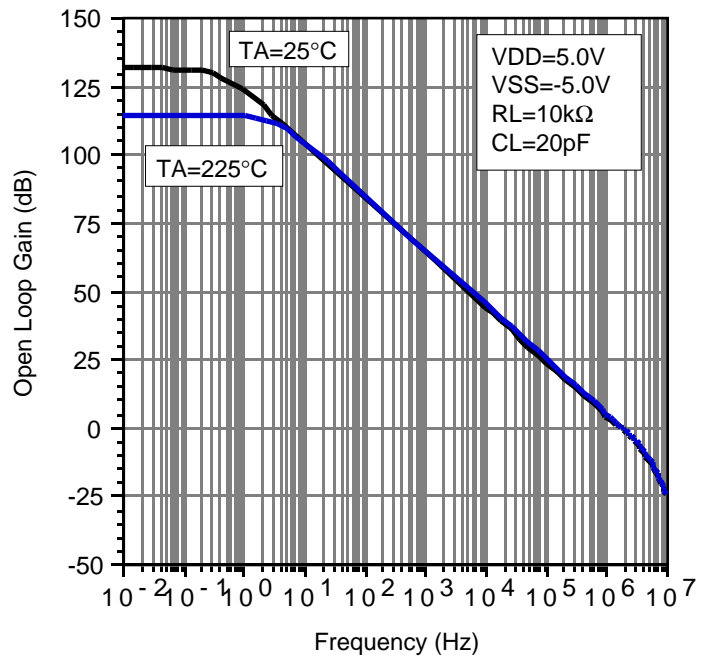

MAXIMUM OUTPUT SWING vs. LOAD CURRENT

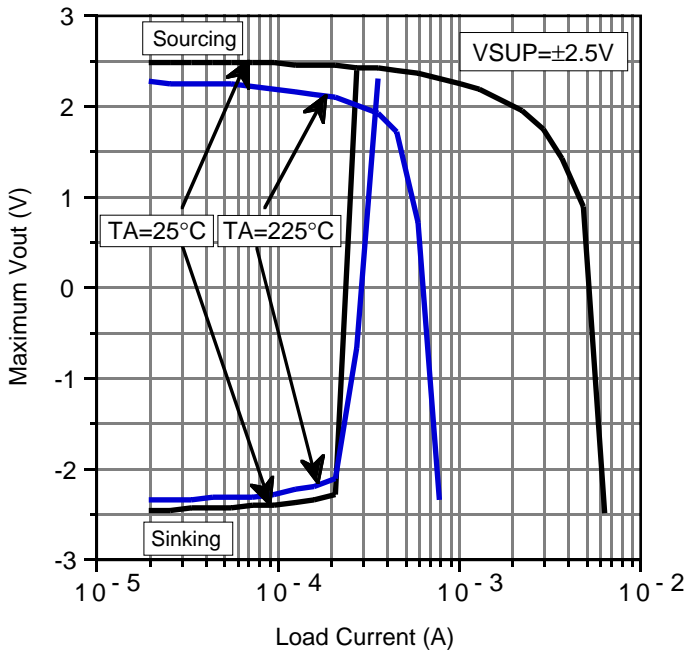

MAXIMUM OUTPUT SWING vs. LOAD CURRENT

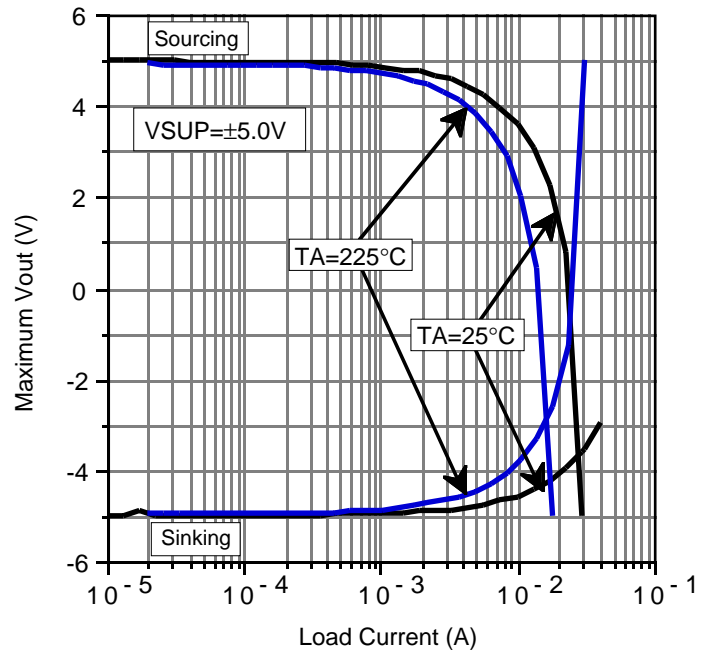

POSITIVE POWER SUPPLY REJECTION vs. FREQUENCY

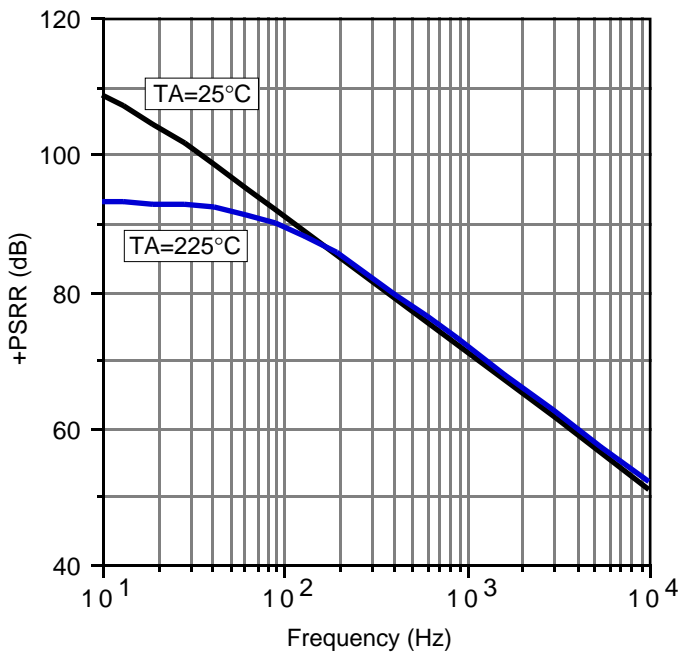

NEGATIVE POWER SUPPLY REJECTION vs. FREQUENCY

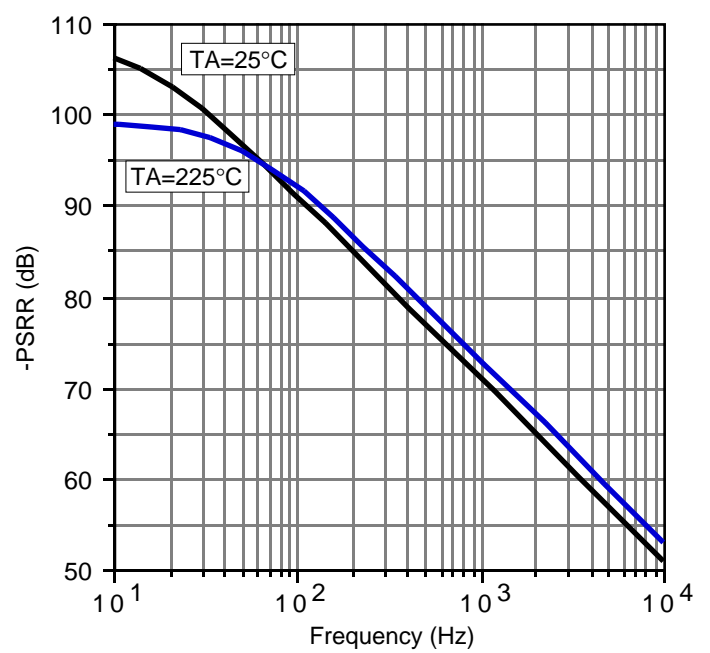

UPPER COMMON MODE LIMIT vs. TEMPERATURE

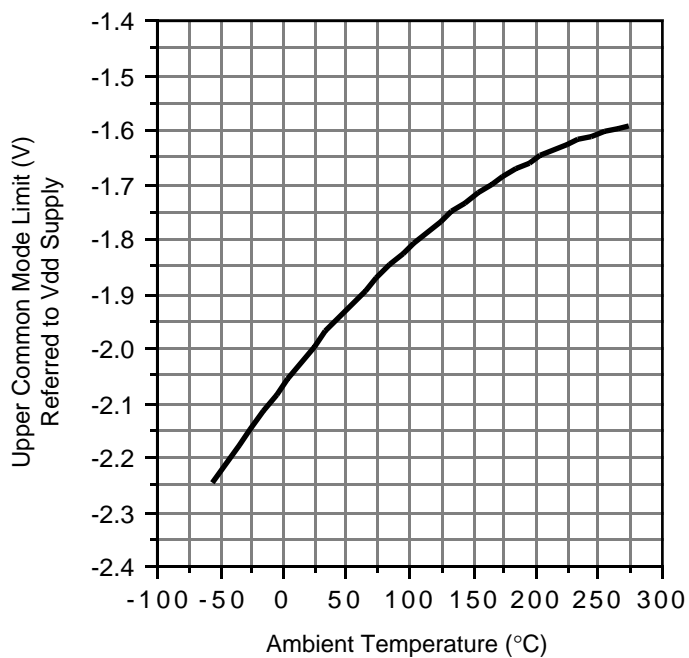

INPUT REFERRED NOISE VOLTAGE vs. FREQUENCY

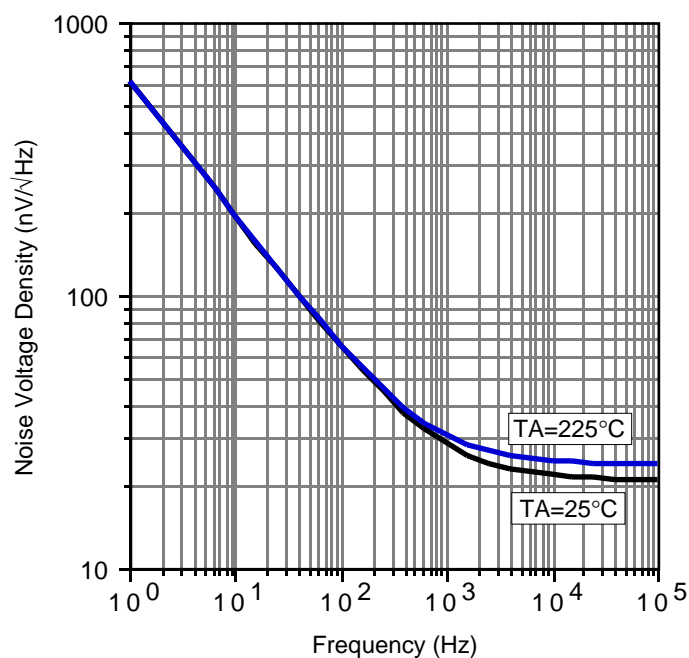

SMALL SIGNAL PULSE RESPONSE

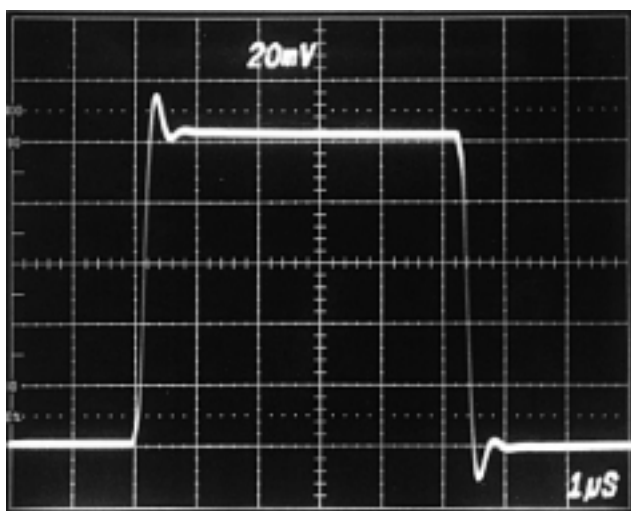

TA=25°C, CL=20pF, Av=+1

SMALL SIGNAL PULSE RESPONSE

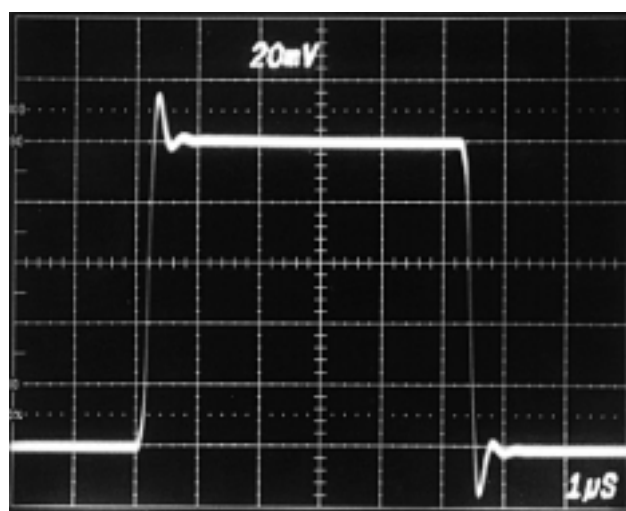

TA=225°C, CL=20pF, Av=+1

Small Signal Step Response

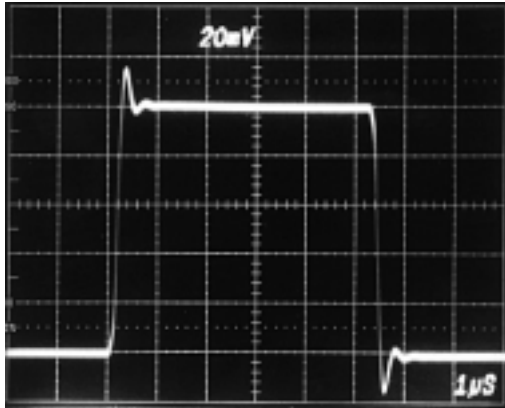

TA=225°C, CL=20pF

Large Signal Step Response

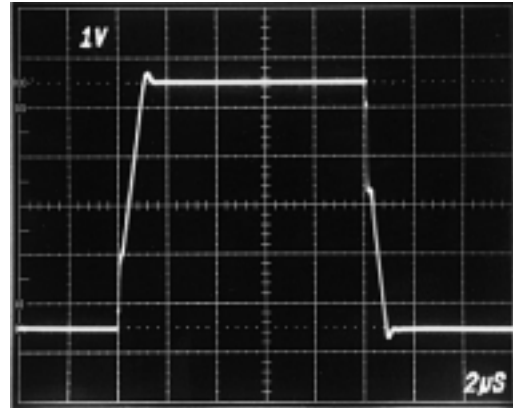

TA=225°C, CL=20pF

Small Signal Step Response

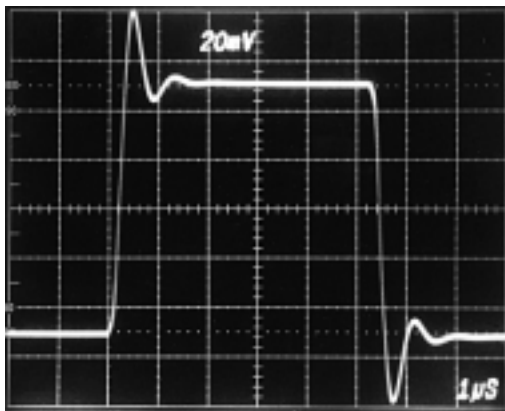

TA=25°C, CL=100pF

Large Signal Step Response

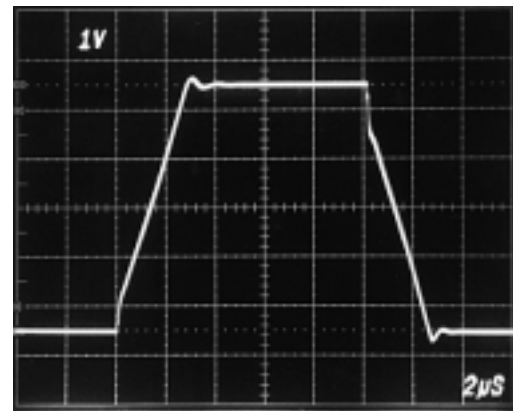

TA=25°C, CL=100pF

Small Signal Step Response

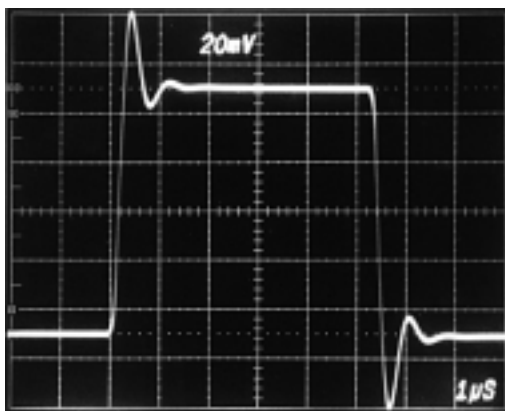

TA=225°C, CL=100pF

Large Signal Step Response

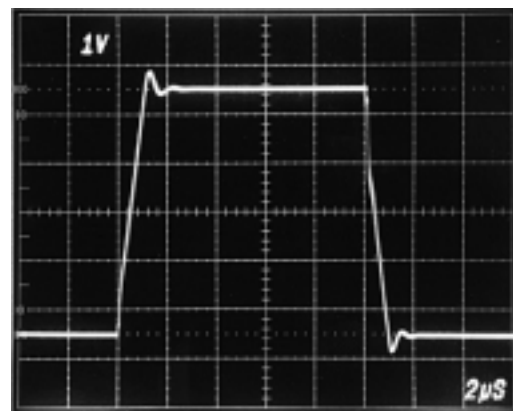

TA=225°C, CL=100pF

Honeywell reserves the right to make changes to any products or technology herein to improve reliability, function or design. Honeywell does not assume any liability arising out of the application or use of any product or circuit described herein; neither does it convey any license under its patent rights nor the rights of others.