

1A Fixed and Adjustable Low Dropout Positive Voltage Regulators

General Description

The RT9164A series of high performance positive voltage regulators is designed for applications requiring low dropout performance at fully rated current. Additionally, the RT9164A series provides excellent regulation over variations in line and load. Outstanding features include low dropout performance at rated current, fast transient response, internal current-limiting, and thermal-shutdown protection of the output device. The RT9164A series of three terminal regulators offers fixed and adjustable voltage options available in space-saving SOT-223, TO-252, and TO-263 packages.

Ordering Information

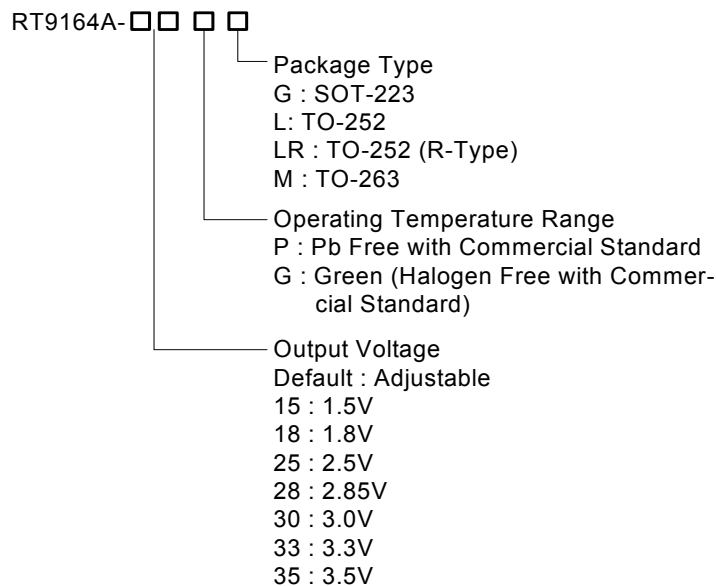

Note :

RichTek Pb-free and Green products are :

- ▶RoHS compliant and compatible with the current requirements of IPC/JEDEC J-STD-020.
- ▶Suitable for use in SnPb or Pb-free soldering processes.
- ▶100%matte tin (Sn) plating.

Features

- **Low Dropout Performance, 1.4V Max.**
- **Full Current Rating Over Line and Temperature**
- **Fast Transient Response**
- **± 2% Output Voltage Accuracy**
- **1.5V, 1.8V, 2.5V, 2.85V, 3.0V, 3.3V, and 3.5V Fixed Adjustable Output Voltage**
- **SOT-223, TO-252, and TO-263 Packages**
- **RoHS Compliant and 100% Lead (Pb)-Free**

Applications

- Active SCSI Termination
- Low Voltage Microcontrollers
- Switching Power Supply Post-Regulator

Pin ConFIGurations

(TOP VIEW)

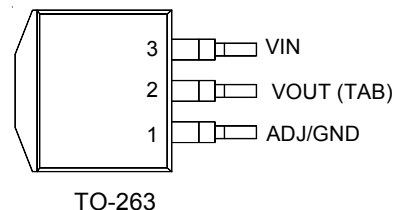
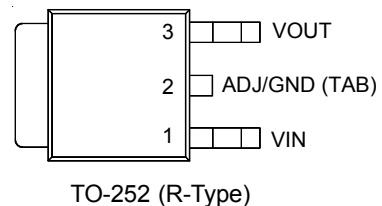
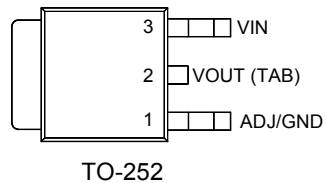
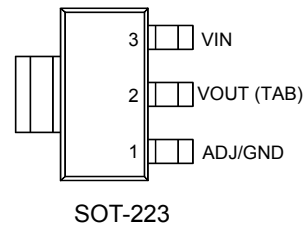

Typical Application Circuit

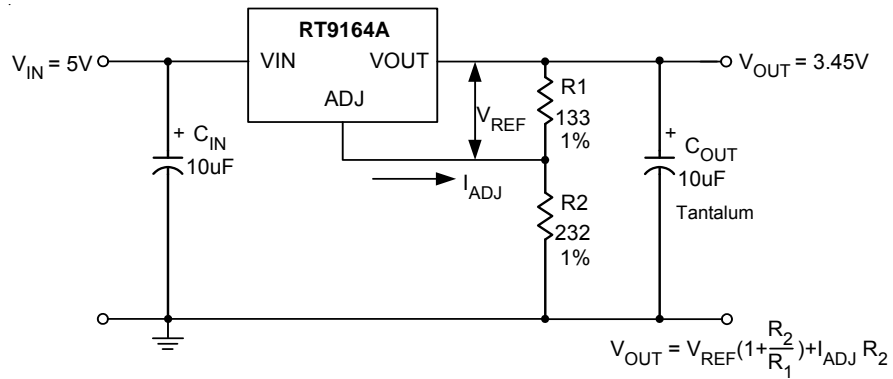

- (1) C_{IN} needed if device is far from filter capacitors.
- (2) C_{OUT} required for stability.

Figure 1. Adjustable Voltage Regulator

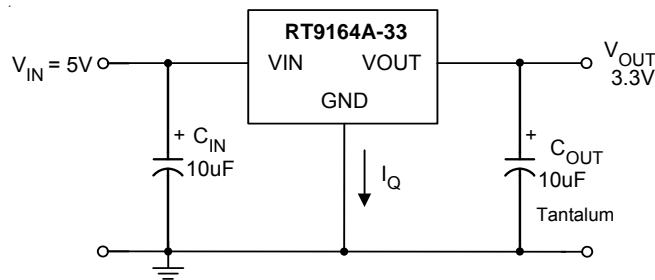

- (1) C_{IN} needed if device is far from filter capacitors.
- (2) C_{OUT} required for stability.

Figure 2. Fixed Voltage Regulator

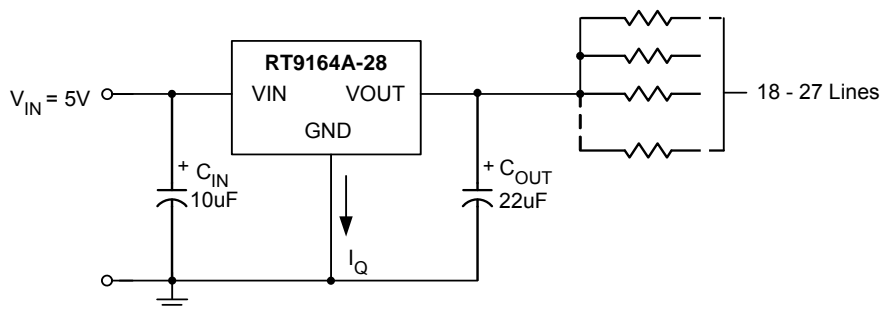
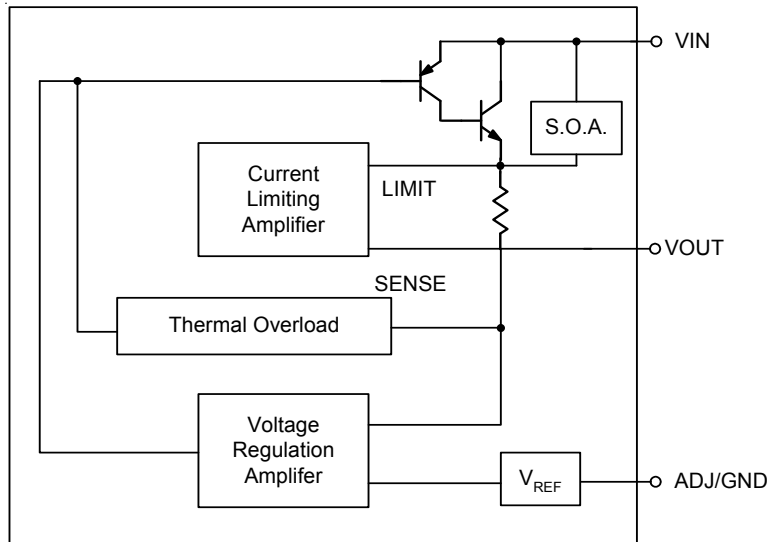

Figure 3. Active SCSI Bus Terminator

Function Block Diagram



Functional Pin Description

Pin Name	Pin Function
ADJ/GND	Adjust Output or Ground
VOUT	Output Voltage
VIN	Power Input

Absolute Maximum Ratings (Note 1)

- Supply Input Voltage ----- 15V
- Power Dissipation, $P_D @ T_A = 25^\circ\text{C}$
 - SOT-223 ----- 0.740W
 - TO-252 ----- 1.471W
 - TO-263 ----- 2.222W
- Package Thermal Resistance (Note 6)
 - SOT-223, θ_{JA} ----- 135°C/W
 - SOT-223, θ_{JC} ----- 19°C/W
 - TO-252, θ_{JA} ----- 68°C/W
 - TO-252, θ_{JC} ----- 7.5°C/W
 - TO-263, θ_{JA} ----- 45°C/W
 - TO-263, θ_{JC} ----- 7.8°C/W
- Lead Temperature (Soldering, 10 sec.) ----- 260°C
- Junction Temperature ----- 150°C
- Storage Temperature Range ----- -65°C to 150°C
- ESD Susceptibility (Note 2)
 - HBM (Human Body Mode) ----- 8 kV
 - MM (Machine Mode) ----- 750V

Recommended Operating Conditions (Note 3)

- Supply Input Voltage ----- 3V to 14V
- Junction Temperature Range ----- -40°C to 125°C

Electrical Characteristics

($T_A = 25^\circ\text{C}$, unless otherwise specified)

Parameter		Symbol	Test Conditions	Min	Typ	Max	Units
Reference Voltage (Note 4)	RT9164A	V_{REF}	$I_{OUT} = 10\text{mA}$, $(V_{IN} - V_{OUT}) = 2\text{V}$, $T_A = 25^\circ\text{C}$	1.243	1.256	1.281	V
			$10\text{mA} < I_{OUT} < 1.0\text{A}$, $1.5\text{V} < V_{IN} - V_{OUT} < 10\text{V}$	1.231	1.256	1.294	V
Output Voltage (Note 4)	RT9164A -15	V_{OUT}	$I_{OUT} = 10\text{mA}$, $V_{IN} = 3.3\text{V}$, $T_J = 25^\circ\text{C}$	1.485	1.5	1.53	V
			$10\text{mA} < I_{OUT} < 1.0\text{A}$, $3.3\text{V} < V_{IN} < 10\text{V}$	1.470	1.5	1.55	
	RT9164A -18		$I_{OUT} = 10\text{mA}$, $V_{IN} = 3.3\text{V}$, $T_J = 25^\circ\text{C}$	1.797	1.815	1.85	
			$10\text{mA} < I_{OUT} < 1.0\text{A}$, $3.3\text{V} < V_{IN} < 10\text{V}$	1.779	1.815	1.87	
	RT9164A -25		$I_{OUT} = 10\text{mA}$, $V_{IN} = 4.0\text{V}$, $T_J = 25^\circ\text{C}$	2.475	2.500	2.550	
			$10\text{mA} < I_{OUT} < 1.0\text{A}$, $4.0\text{V} < V_{IN} < 10\text{V}$	2.450	2.500	2.575	
	RT9164A -28		$I_{OUT} = 10\text{mA}$, $V_{IN} = 4.25\text{V}$, $T_J = 25^\circ\text{C}$	2.822	2.850	2.910	
			$10\text{mA} < I_{OUT} < 1.0\text{A}$, $4.25\text{V} < V_{IN} < 10\text{V}$	2.793	2.850	2.936	
	RT9164A -30		$I_{OUT} = 10\text{mA}$, $V_{IN} = 4.5\text{V}$, $T_J = 25^\circ\text{C}$	2.970	3.000	3.060	
			$10\text{mA} < I_{OUT} < 1.0\text{A}$, $4.5\text{V} < V_{IN} < 10\text{V}$	2.940	3.000	3.090	

To be continued

Parameter		Symbol	Test Conditions	Min	Typ	Max	Units
Output Voltage (Note 4)	RT9164A -33	V _{OUT}	I _{OUT} = 10mA, V _{IN} = 4.75V, T _J = 25°C	3.267	3.300	3.365	V
			10mA < I _{OUT} < 1.0A, 4.75V < V _{IN} < 10V	3.234	3.300	3.400	
	RT9164A -35		I _{OUT} = 10mA, V _{IN} = 5V, T _J = 25°C	3.465	3.500	3.570	
			10mA < I _{OUT} < 1.0A, 5.0V < V _{IN} < 10V	3.430	3.500	3.605	
Line Regulation (Note 4)	RT9164A	ΔV _{LINE}	I _{OUT} = 10mA, 1.5V ≤ V _{IN} - V _{OUT} ≤ 10V	--	0.1	0.3	%
	RT9164A -15		I _{OUT} = 10mA, 3.3V ≤ V _{IN} ≤ 15V	--	1	6	mV
	RT9164A -18		I _{OUT} = 10mA, 3.3V ≤ V _{IN} ≤ 15V	--	1	6	mV
	RT9164A -25		I _{OUT} = 10mA, 4.0V ≤ V _{IN} ≤ 15V	--	1	6	mV
	RT9164A -28		I _{OUT} = 10mA, 4.25V ≤ V _{IN} ≤ 15V	--	1	6	mV
	RT9164A -30		I _{OUT} = 10mA, 4.5V ≤ V _{IN} ≤ 15V	--	1	6	mV
	RT9164A -33		I _{OUT} = 10mA, 4.75V ≤ V _{IN} ≤ 15V	--	1	6	mV
	RT9164A -35		I _{OUT} = 10mA, 5.0V ≤ V _{IN} ≤ 15V	--	1	6	mV
Load Regulation (Note 4)	RT9164A	ΔV _{LOAD}	(V _{IN} - V _{OUT}) = 3V, 10mA ≤ I _{OUT} ≤ 1.0A	--	0.2	0.4	%
	RT9164A -15		V _{IN} = 3.3V, 10mA ≤ I _{OUT} ≤ 1.0A	--	1	10	mV
	RT9164A -18		V _{IN} = 3.3V, 10mA ≤ I _{OUT} ≤ 1.0A	--	1	10	mV
	RT9164A -25		V _{IN} = 4.0V, 10mA ≤ I _{OUT} ≤ 1.0A	--	1	10	mV
	RT9164A -28		V _{IN} = 4.25V, 10mA ≤ I _{OUT} ≤ 1.0A	--	1	10	mV
	RT9164A -30		V _{IN} = 4.5V, 10mA ≤ I _{OUT} ≤ 1.0A	--	1	12	mV
	RT9164A -33		V _{IN} = 4.75V, 10mA ≤ I _{OUT} ≤ 1.0A	--	1	12	mV
	RT9164A -35		V _{IN} = 5.0V, 10mA ≤ I _{OUT} ≤ 1.0A	--	1	15	mV
Dropout Voltage (Note 5)		V _{DROP}	I _{OUT} = 500mA	--	1.15	1.25	V
			I _{OUT} = 1.0A	--	1.3	1.4	V
Current Limit		I _{LIM}	V _{IN} = 5V	1.0	1.8	--	A
Minimum Load Current	RT9164A		(V _{IN} - V _{OUT}) = 2V	--	5	10	mA
Quiescent Current	RT9164A -XX	I _Q	V _{IN} = 5V	--	5	10	mA
Ripple Rejection		PSRR	f _{RIPPLE} = 120Hz, (V _{IN} - V _{OUT}) = 2V, V _{RIPPLE} = 1V _{P-P}	--	72	--	dB
Adjust Pin Current		I _{ADJ}		--	65	120	μA
Adjust Pin Current Change		ΔI _{ADJ}	10mA ≤ I _{OUT} ≤ 1.0A, V _{IN} = 5V	--	0.2	5	μA

- Note 1.** Stresses listed as the above “Absolute Maximum Ratings” may cause permanent damage to the device. These are for stress ratings. Functional operation of the device at these or any other conditions beyond those indicated in the operational sections of the specifications is not implied. Exposure to absolute maximum rating conditions for extended periods may remain possibility to affect device reliability.
- Note 2.** Devices are ESD sensitive. Handling precaution recommended.
- Note 3.** The device is not guaranteed to function outside its operating conditions.
- Note 4.** Low duty cycle pulse testing with Kelvin connections.
- Note 5.** The dropout voltage is defined as $V_{IN} - V_{OUT}$, which is measured when V_{OUT} is $V_{OUT(NORMAL)} - 100mV$.
- Note 6.** θ_{JA} is measured in the natural convection at $T_A = 25^\circ C$ on a low effective thermal conductivity test board of JEDEC 51-3 thermal measurement standard. The case point of θ_{JC} is on the center of the exposed pad. The pad size is $6mm^2$ on SOT-223 packages, $100mm^2$ on TO-252 packages, $125mm^2$ on TO-263 packages.

Typical Operating Characteristics

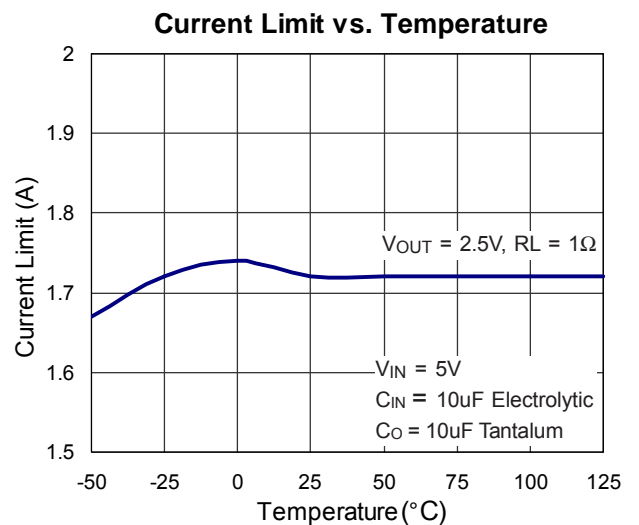
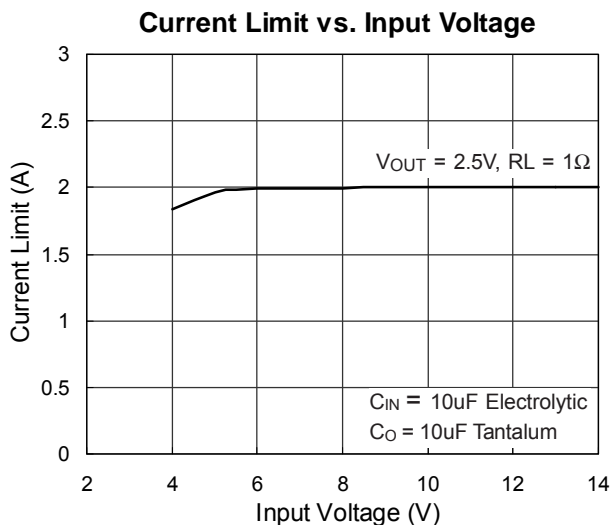
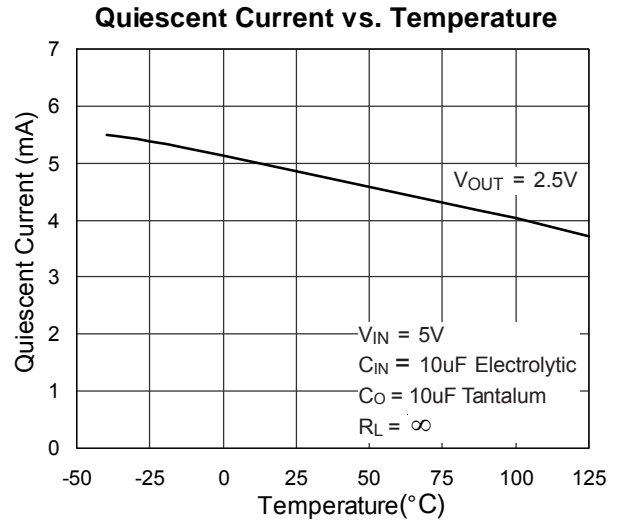
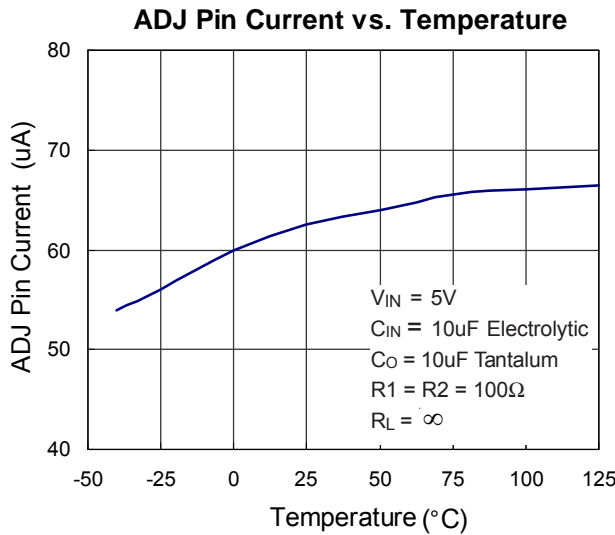
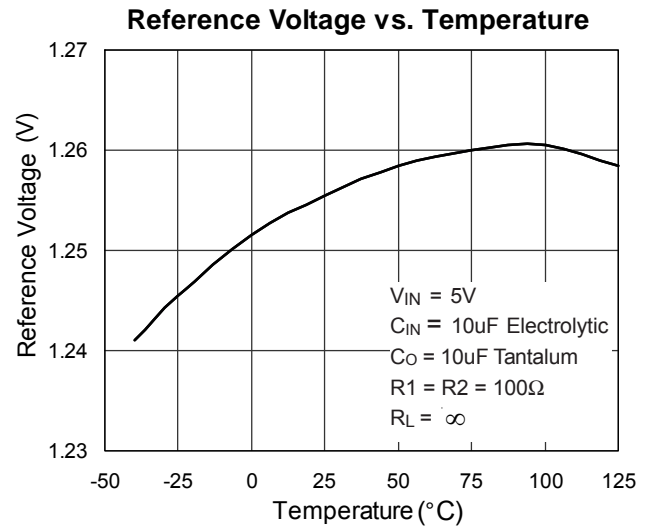
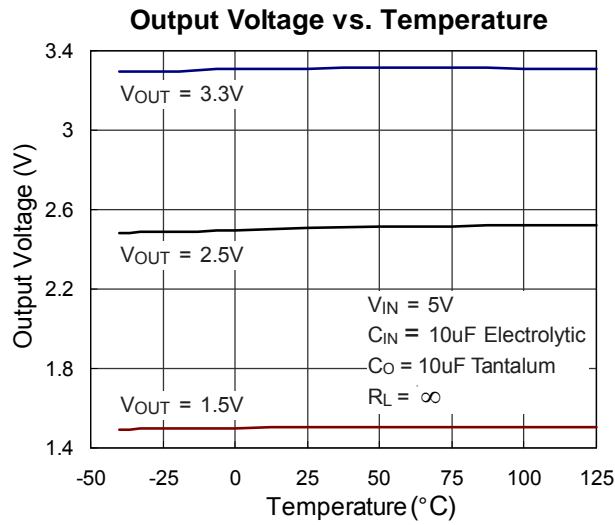

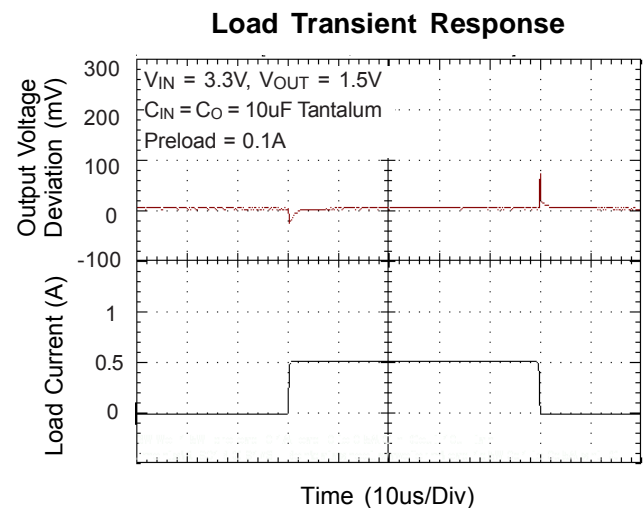
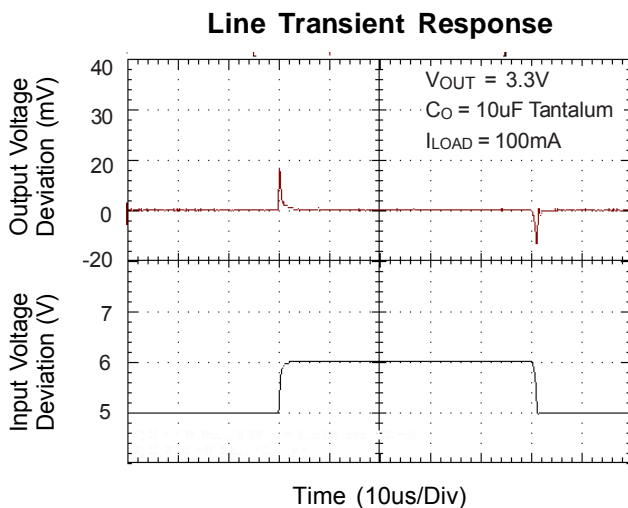
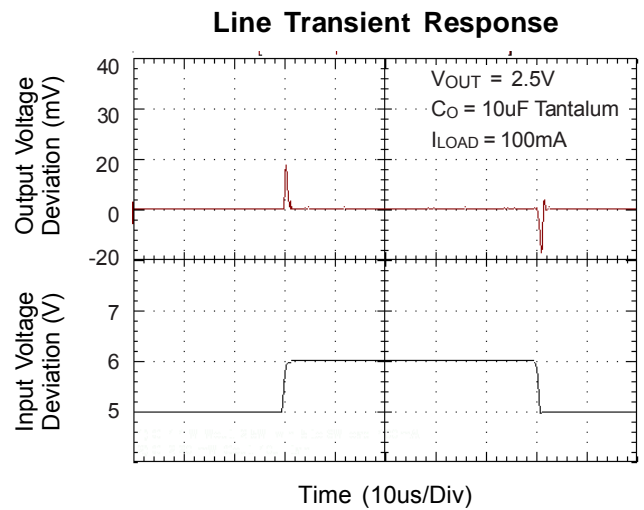
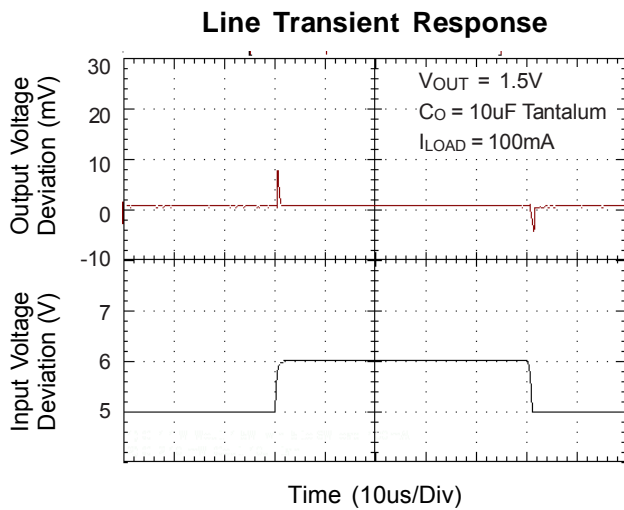
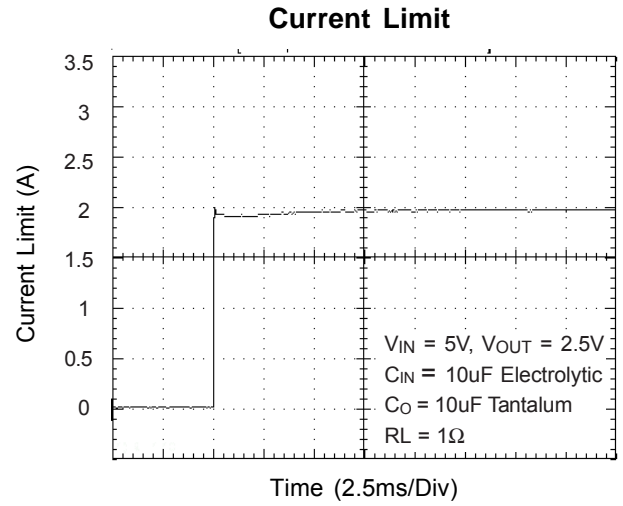
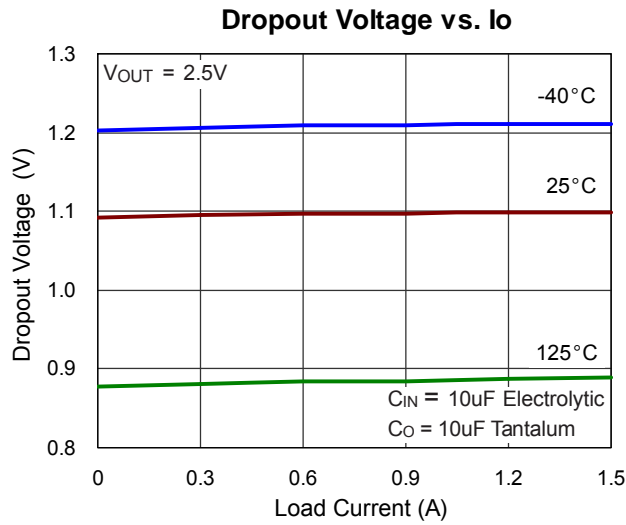

Load Transient Response

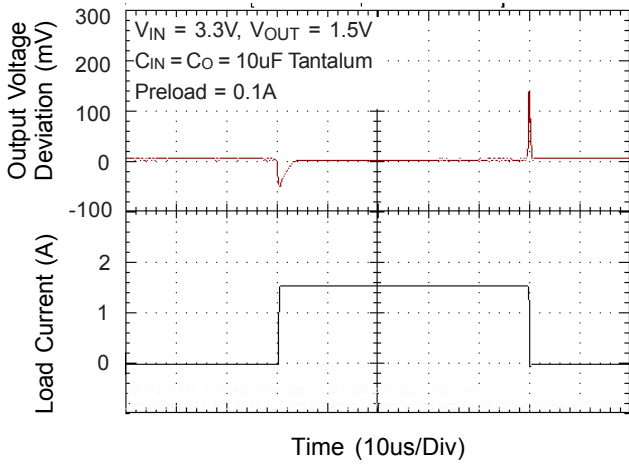

Load Transient Response

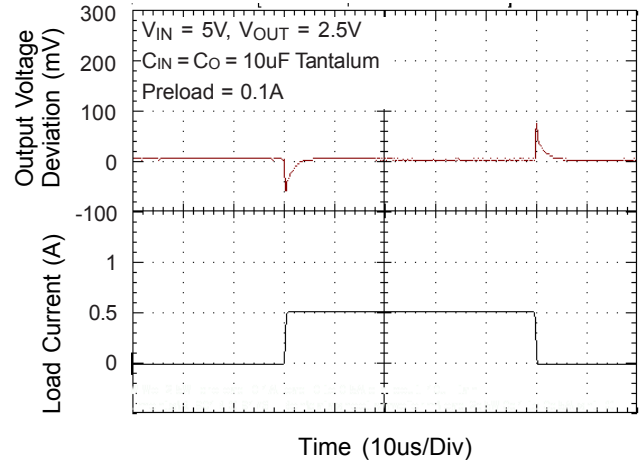

Load Transient Response

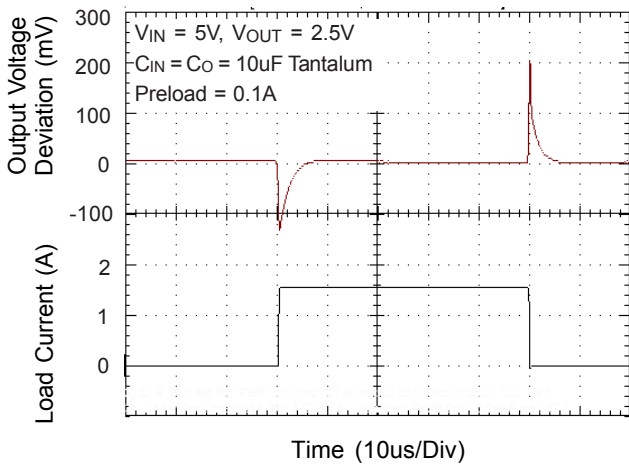

Load Transient Response

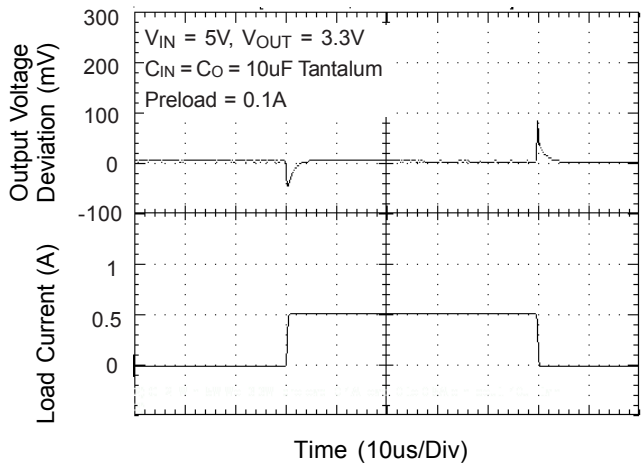

Load Transient Response

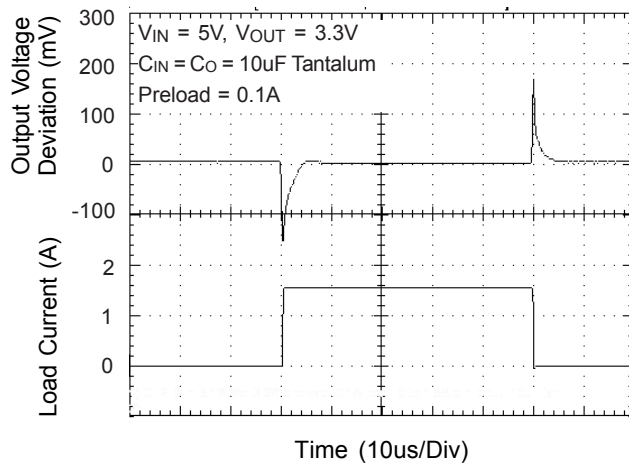

Application Information

Output voltage adjustment

Like most regulators, the RT9164A regulates the output by comparing the output voltage to an internally generated reference voltage. On the adjustable version as shown in Figure 4, the V_{REF} is available externally as 1.25V between V_{OUT} and ADJ. The voltage ratio formed by R1 and R2 should be set to conduct 10mA (minimum output load). The output voltage is given by the following equation:

$$V_{OUT} = V_{REF} \left(1 + \frac{R_2}{R_1}\right) + I_{ADJ} R_2$$

On fixed versions of RT9164A, the voltage divider is provided internally.

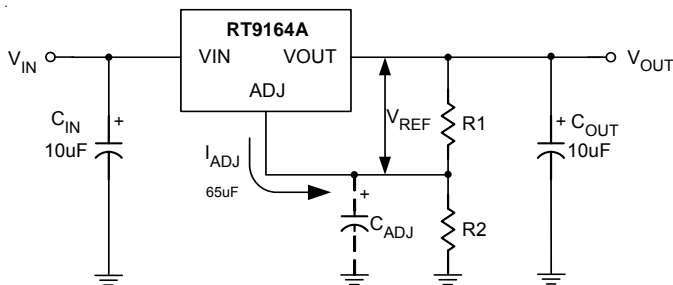

Figure 4. Basic Adjustable Regulator

Input Bypass Capacitor

An input capacitor is recommended. A 10µF tantalum on the input is a suitable input bypassing for almost all applications.

Adjust Terminal Bypass Capacitor

The adjust terminal can be bypassed to ground with a bypass capacitor (C_{ADJ}) to improve ripple rejection. This bypass capacitor prevents ripple from being amplified as the output voltage is increased. At any ripple frequency, the impedance of the C_{ADJ} should be less than R1 to prevent the ripple from being amplified:

$$(2\pi \times f_{RIPPLE} \times C_{ADJ}) < R_1$$

The R1 is the resistor between the output and the adjust pin. Its value is normally in the range of 100-200Ω. For example, with $R_1 = 124\Omega$ and $f_{RIPPLE} = 120\text{Hz}$, the C_{ADJ} should be $> 11\mu\text{F}$.

Output Capacitor

RT9164A requires a capacitor from V_{OUT} to GND to provide compensation feedback to the internal gain stage. This is to ensure stability at the output terminal. Typically, 10µF tantalum or 50µF aluminum electrolytic with 30mΩ to 2Ω range capacitor is sufficient.

The output capacitor does not have a theoretical upper limit and increasing its value will increase stability. $C_{OUT} = 100\mu\text{F}$ or more is typical for high current regulator design.

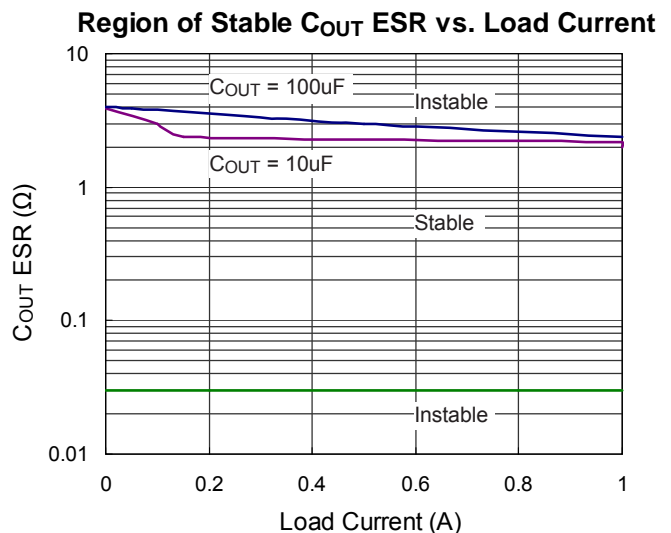

Figure 5

Load Regulation

When the adjustable regulator is used (Figure 6), the best load regulation is accomplished when the top of the resistor divider (R1) is connected directly to the output pin of the RT9164A. When so connected, R_P is not multiplied by the divider ratio. For Fixed output version, the top of R1 is internally connected to the output and ground pins can be connected to low side of the load.

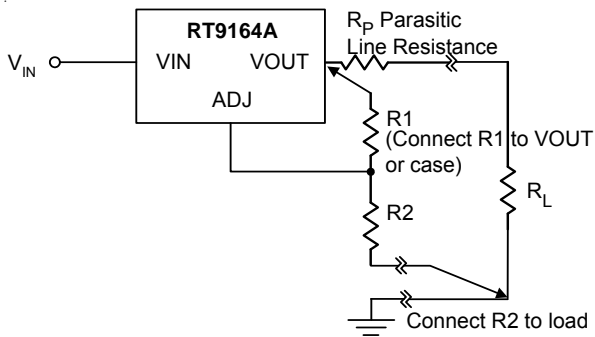

Figure 6. Best Load Regulation Using Adjustable Output Regulator

Thermal Protection

RT9164A has thermal protection which limits junction temperature to 150°C. However, device functionality is only guaranteed to a maximum junction temperature of +125°C. The power dissipation and junction temperature for RT9164A are given by

$$P_D = (V_{IN} - V_{OUT}) \times I_{OUT}$$

$$T_{JUNCTION} = T_{AMBIENT} + (P_D \times \theta_{JA})$$

Note: T_{JUNCTION} must not exceed 125°C

Current Limit Protection

RT9164A is protected against overload conditions. Current protection is triggered at typically 1.8A.

Thermal Consideration

The RT9164A series contain thermal limiting circuitry designed to protect itself from over-temperature conditions. Even for normal load conditions, maximum junction temperature ratings must not be exceeded. As mention in thermal protection section, we need to consider all sources of thermal resistance between junction and ambient. It includes junction-to-case, case-to-heat-sink interface, and heat sink thermal resistance itself.

Junction-to-case thermal resistance is specified from the IC junction to the bottom of the case directly below the die. Proper mounting is required to ensure the best possible thermal flow from this area of the package to the heat sink. The case of all devices in this series is electrically connected to the output. Therefore, if the case of the device must be electrically isolated, a thermally conductive spacer is recommended.

Outline Dimension

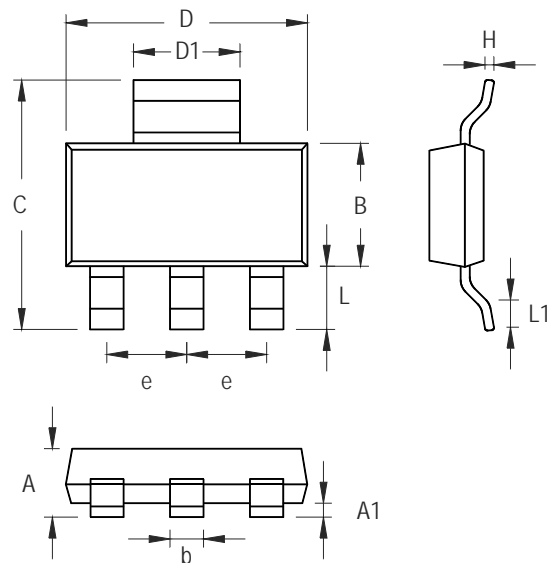

Symbol	Dimensions In Millimeters		Dimensions In Inches	
	Min	Max	Min	Max
A	1.450	1.803	0.057	0.071
A1	0.020	0.100	0.0008	0.0047
b	0.610	0.787	0.024	0.031
B	3.302	3.708	0.130	0.146
C	6.706	7.290	0.264	0.287
D	6.299	6.706	0.248	0.264
D1	2.896	3.150	0.114	0.124
e	2.261	2.362	0.089	0.093
H	0.229	0.330	0.009	0.013
L	1.550	1.950	0.061	0.077
L1	0.800	1.100	0.009	0.013

3-Lead SOT-23 Surface Mount Package

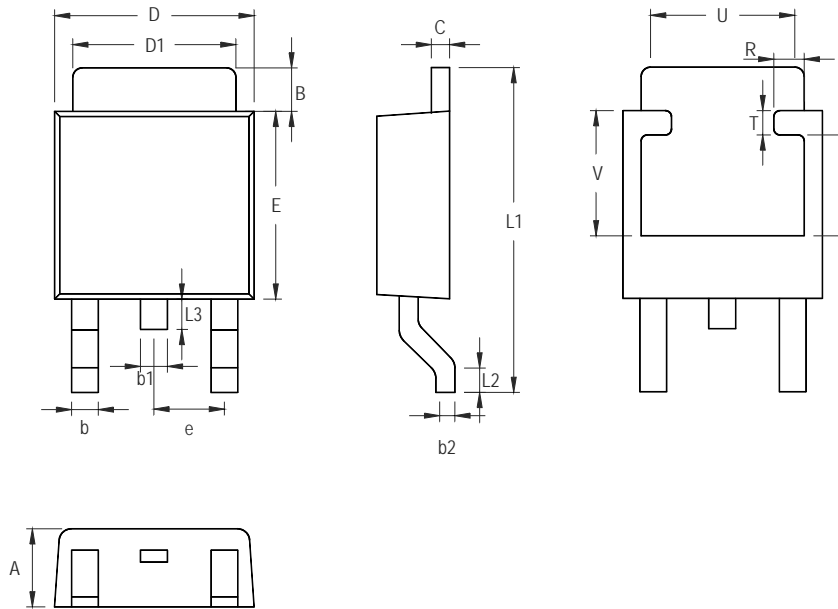

Symbol	Dimensions In Millimeters		Dimensions In Inches	
	Min	Max	Min	Max
A	2.184	2.388	0.086	0.094
B	0.889	2.032	0.035	0.080
b	0.508	0.889	0.020	0.035
b1	1.016 Ref.		0.040 Ref.	
b2	0.457	0.584	0.018	0.023
C	0.457	0.584	0.018	0.023
D	6.350	6.731	0.250	0.265
D1	5.207	5.461	0.205	0.215
E	5.334	6.223	0.210	0.245
e	2.108	2.438	0.083	0.096
L1	9.398	10.414	0.370	0.410
L2	0.508 Ref.		0.020 Ref.	
L3	0.635	1.016	0.025	0.040
U	3.810 Ref.		0.150 Ref.	
V	3.048 Ref.		0.120 Ref.	
R	0.200	0.850	0.008	0.033
S	2.500	3.400	0.098	0.134
T	0.500	0.850	0.020	0.033

3-Lead TO-252 Surface Mount Package

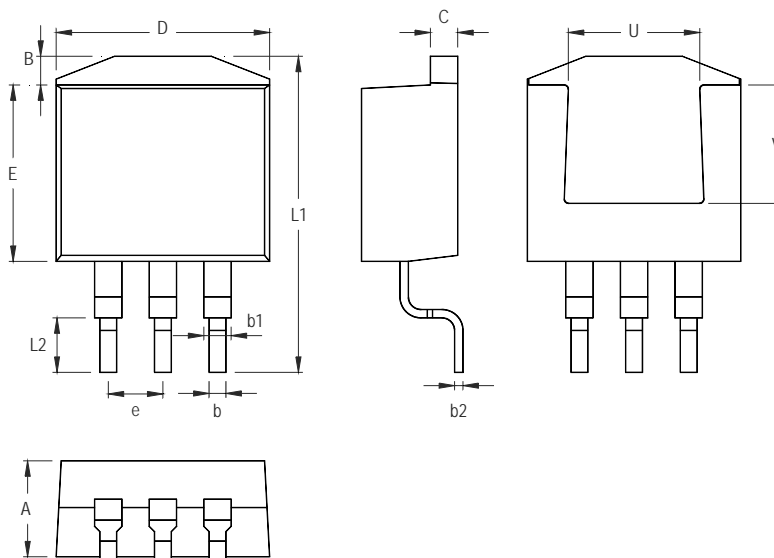

Symbol	Dimensions In Millimeters		Dimensions In Inches	
	Min	Max	Min	Max
A	4.064	4.826	0.160	0.190
B	1.143	1.676	0.045	0.066
b	0.660	0.914	0.026	0.036
b1	1.143	1.397	0.045	0.055
b2	0.305	0.584	0.012	0.023
C	1.143	1.397	0.045	0.055
D	9.652	10.668	0.380	0.420
E	8.128	9.652	0.320	0.380
e	2.286	2.794	0.090	0.110
L1	14.605	15.875	0.575	0.625
L2	2.286	2.794	0.090	0.110
U	6.223 Ref.		0.245 Ref.	
V	7.620 Ref.		0.300 Ref.	

3-Lead TO- 263 Surface Mount Package

Richtek Technology Corporation

Headquarter
 5F, No. 20, Taiyuen Street, Chupei City
 Hsinchu, Taiwan, R.O.C.
 Tel: (8863)5526789 Fax: (8863)5526611

Richtek Technology Corporation

Taipei Office (Marketing)
 8F, No. 137, Lane 235, Paochiao Road, Hsintien City
 Taipei County, Taiwan, R.O.C.
 Tel: (8862)89191466 Fax: (8862)89191465
 Email: marketing@richtek.com