

6 Channels 150mA x1/x1.5/x2 Charge Pump White LED Driver

General Description

The RT9379 is a 6 channel WLED driver with auto mode selection of x1, x1.5 and x2 mode with low dropout voltage in current sources. The RT9379 can power up to 6 white LEDs with regulated constant current for uniform intensity. Each channel (LED1 to LED6) can support up to 25mA. The part maintains highest efficiency by utilizing x1/x1.5/x2 fractional charge pump and low dropout current regulators. For the brightness control, user can easily use a PWM signal generated from GPIO to control the brightness of WLEDs.

The RT9379 is available in a WQFN-16L 2x3 package. Small 1μF capacitors can be used for fly capacitors. It provides the best backlighting solution with high efficiency and smallest board space for portable application.

Ordering Information

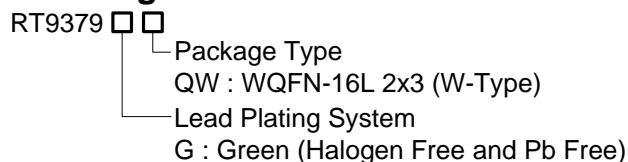

Note :

Richtek products are :

- ▶ RoHS compliant and compatible with the current requirements of IPC/JEDEC J-STD-020.
- ▶ Suitable for use in SnPb or Pb-free soldering processes.

Marking Information

For marking information, contact our sales representative directly or through a Richtek distributor located in your area.

Features

- 85% Average Efficiency Over Li-ion Battery Discharge
- Support Up to 6 White LEDs
- Support Up to 25mA/Per Channel
- PWM Brightness Control
- 60mV Current Source Dropout
- 1% LED Current Accuracy
- 0.7% LED Current Matching
- Automatic x1/x1.5/x2 Charge Pump Mode Transition
- Low Input Noise and EMI
- Over Voltage Protection
- Power On/Mode Transition Inrush Protection
- 1MHz Switching Frequency
- 0.4uA Low Shutdown Current
- RoHS Compliant and Halogen Free

Applications

- Camera Phone, Smart Phone
- White LED Backlighting

Pin Configurations

(TOP VIEW)

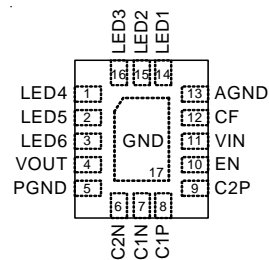

WQFN-16L 2x3

Typical Application Circuit

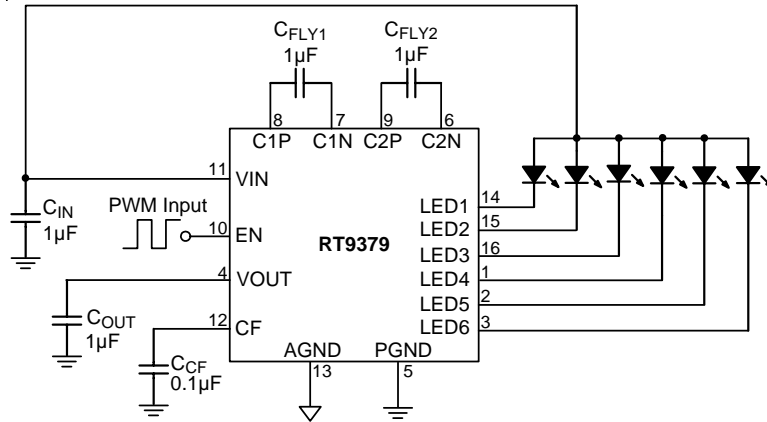

Function Block Diagram

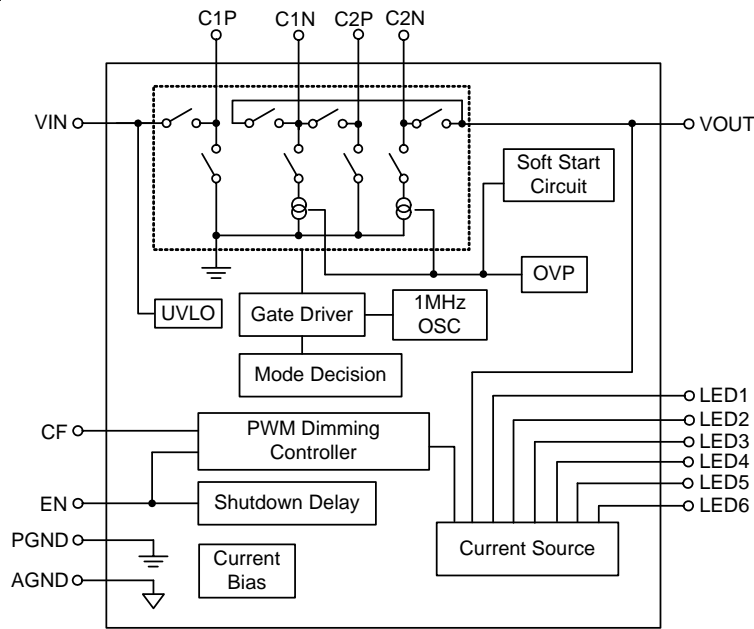

Functional Pin Description

Pin No.	Pin Name	Pin Function
1	LED4	Current Sink for LED4. (If not in use, this pin should be connected to VIN)
2	LED5	Current Sink for LED5. (If not in use, this pin should be connected to VIN)
3	LED6	Current Sink for LED6. (If not in use, this pin should be connected to VIN)
4	VOUT	Charge Pump Output.
5	PGND	Ground.
6	C2N	Fly Capacitor 2 Negative Connection.
7	C1N	Fly Capacitor 1 Negative Connection.
8	C1P	Fly Capacitor 1 Positive Connection.
9	C2P	Fly Capacitor 2 Positive Connection.
10	EN	Chip Enable (Active High).
11	VIN	Power Input.
12	CF	PWM Filter Capacitor Connection, No Connection if this pin is not in use.
13	AGND	Ground.
14	LED1	Current Sink for LED1. (If not in use, this pin should be connected to VIN)
15	LED2	Current Sink for LED2. (If not in use, this pin should be connected to VIN)
16	LED3	Current Sink for LED3. (If not in use, this pin should be connected to VIN)
17 (Exposed Pad)	GND	The exposed pad must be soldered to a large PCB and connected to GND for maximum power dissipation.

Absolute Maximum Ratings (Note 1)

- Supply Input Voltage, V_{IN} ----- -0.3V to 5V
- Power Dissipation, P_D @ $T_A = 25^\circ\text{C}$
 WQFN-16L 2x3 ----- 1.111W
- Package Thermal Resistance (Note 2)
 WQFN-16L 2x3, θ_{JA} ----- 90°C/W
 WQFN-16L 2x3, θ_{JC} ----- 15°C/W
- Junction Temperature ----- 150°C
- Lead Temperature (Soldering, 10 sec.) ----- 260°C
- Storage Temperature Range ----- -65°C to 150°C
- ESD Susceptibility (Note 3)
 HBM (Human Body Mode) ----- 2kV
 MM (Machine Mode) ----- 200V

Recommended Operating Conditions (Note 4)

- Junction Temperature Range ----- -40°C to 125°C
- Ambient Temperature Range ----- -40°C to 85°C

Electrical Characteristics

($V_{IN} = 3.6V$, $V_F = 3.5V$, $C_{IN} = C_{OUT} = 1\mu F$, $C_{FLY1} = C_{FLY2} = 1\mu F$, $I_{LED1} \text{ to } LED6 = 25mA$, $T_A = 25^\circ C$, unless otherwise specified)

Parameter	Symbol	Test Conditions	Min	Typ	Max	Units
Input Power Supply						
Input Supply Voltage	V_{IN}		2.8	--	4.5	V
Under-Voltage Lockout Threshold	V_{UVLO}	V_{IN} Rising	1.8	2	2.5	V
Under-Voltage Lockout Hysteresis	ΔV_{UVLO}		--	100	--	mV
Quiescent Current	I_Q	x1 Mode	--	1	2	mA
Shutdown Current	I_{SHDN}	$V_{IN} = 4.5V$	--	0.4	2	μA
LED Current						
LED Current Accuracy	I_{LEDx}	$I_{LEDx} = 25mA$	-5	0	+5	%
Current Matching		$I_{LEDx} = 25mA$	-2	0	+2	%
Charge Pump						
Oscillator Frequency	f_{OSC}		--	1000	--	kHz
PWM Dimming Frequency			1	--	200	kHz
Internal CF Resistance			--	160	--	$k\Omega$
Mode Decision						
x1 Mode to x1.5 Mode Transition Voltage (V_{IN} Falling)		$I_{OUT} = 150mA$, $I_{LEDx} = 25mA$.	--	3.65	3.8	V
Mode Transition Hysteresis		$I_{OUT} = 150mA$, $I_{LEDx} = 25mA$.	--	200	--	mV
Protection						
OVP		$V_{IN} - V_{OUT}$	4.5	5	5.5	V
Enable						
EN Low Time for Shutdown			3	--	--	ms
EN Threshold Voltage	Logic-Low	V_{IL}	--	--	0.2	V
	Logic-High	V_{IH}	1	--	4.5	V
EN Pull Low Current			--	2	--	μA

Note 1. Stresses listed as the above "Absolute Maximum Ratings" may cause permanent damage to the device. These are for stress ratings. Functional operation of the device at these or any other conditions beyond those indicated in the operational sections of the specifications is not implied. Exposure to absolute maximum rating conditions for extended periods may remain possibility to affect device reliability.

Note 2. θ_{JA} is measured in the natural convection at $T_A = 25^\circ C$ on a high effective four layers thermal conductivity test board of JEDEC 51-7 thermal measurement standard. The case point of θ_{JC} is on the exposed pad for the package.

Note 3. Devices are ESD sensitive. Handling precaution is recommended.

Note 4. The device is not guaranteed to function outside its operating conditions.

Typical Operating Characteristics

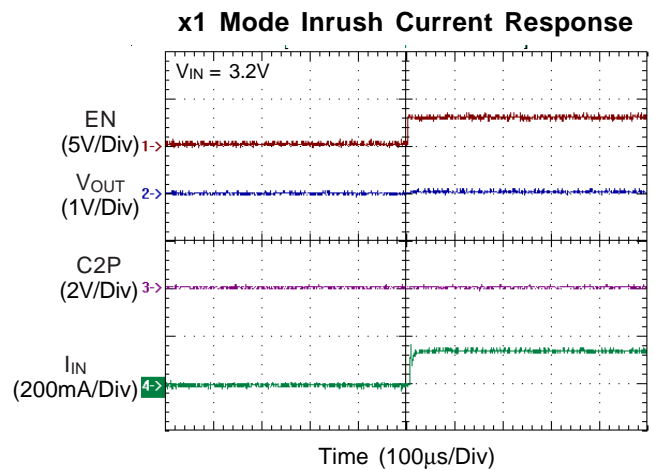
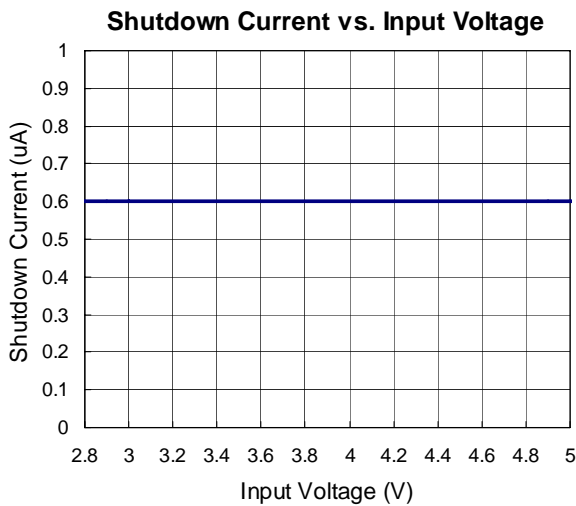
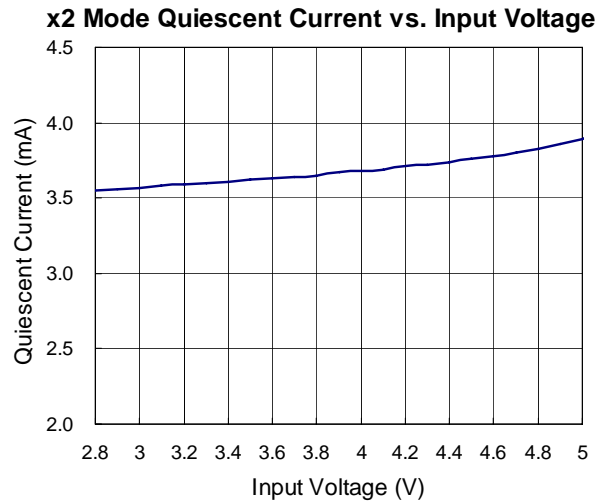
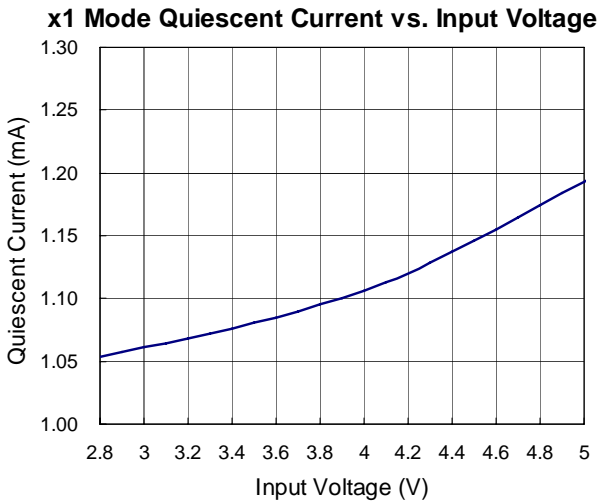
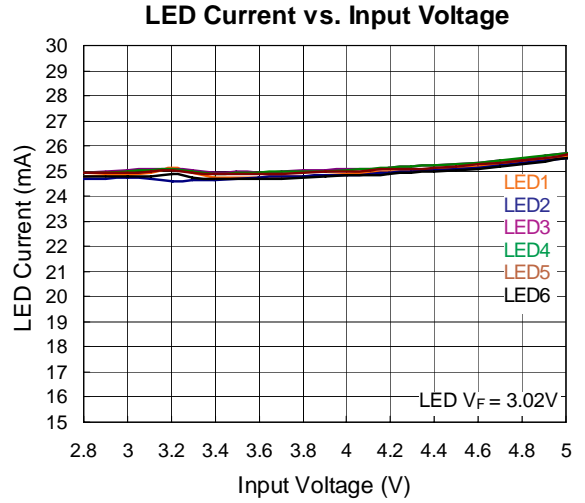
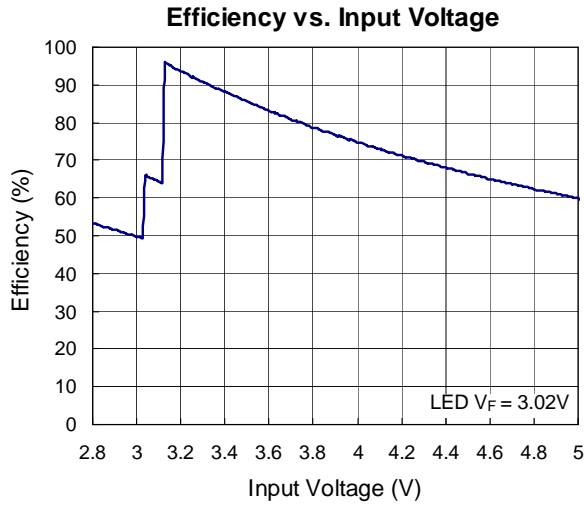

x1.5 Mode Inrush Current Response

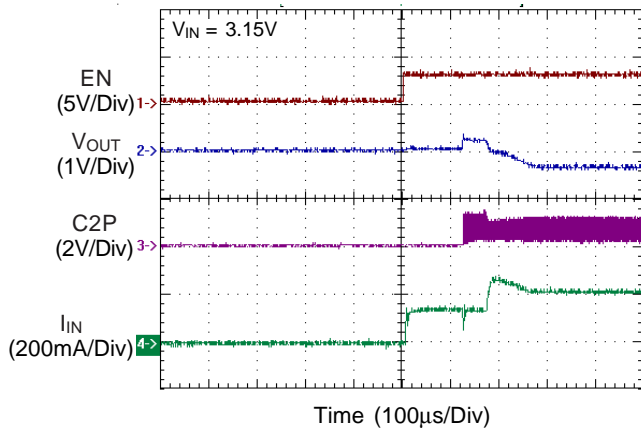

x2 Mode Inrush Current Response

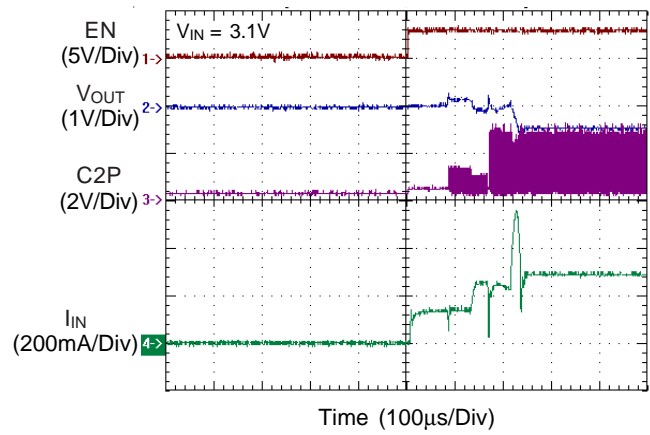

PWM Dimming Operation

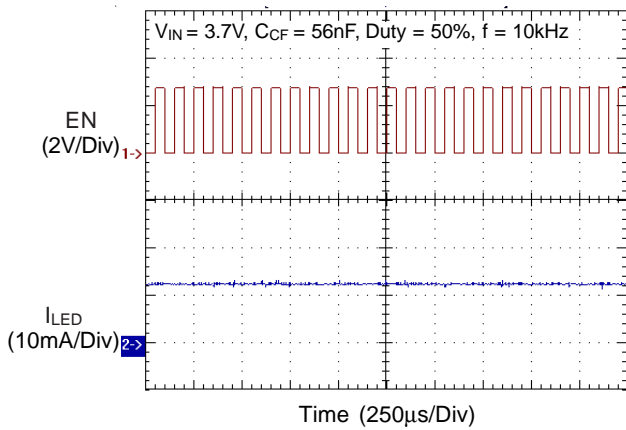

Ripple & Spike

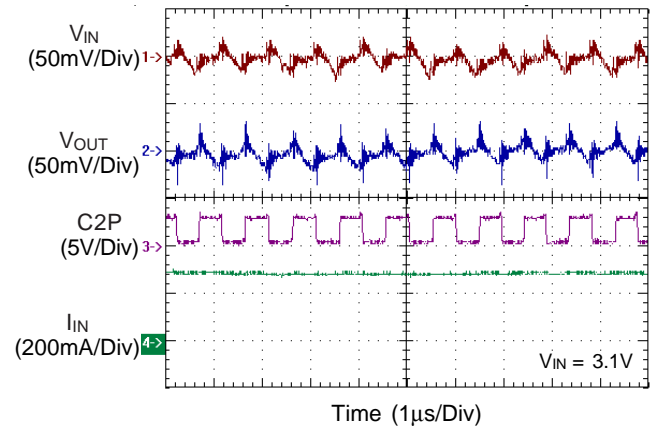

Applications Information

The RT9379 uses a fractional switched capacitor charge pump to power up to six white LEDs with a programmable current for uniform intensity. The part integrates current sources and automatic mode selection charge pump. It maintains the high efficiency by utilizing an x1/x1.5/x2 fractional charge pump and current sources. The small equivalent x1 mode open loop resistance and ultra-low dropout voltage of current source extend the operating time of x1 mode and optimize the efficiency in white LED applications.

Input UVLO

The input operating voltage range of the LED driver is from 2.8V to 4.5V. An input capacitor at the VIN pin could reduce ripple voltage. It is recommended to use a ceramic 1μF or larger capacitance as the input capacitor. The RT9379 provides an under voltage lockout (UVLO) function to prevent it from unstable issue when startup. The UVLO threshold of input rising voltage is set at 2V typically with a hysteresis of 100mV.

Soft Start

The charge pump employs a soft start feature to limit the inrush current. The soft-start circuit prevents the excessive inrush current and input voltage drop. The soft-start clamps the input current in a typical period of 50us.

Mode Decision

The RT9379 uses a smart mode selection method to decide the working mode for optimizing the efficiency. Mode decision circuit senses the output and LED voltage for up/down selection. The RT9379 automatically switches to x1.5 or x2 mode whenever the dropout condition is detected from the current source and returns to x1 mode whenever the dropout condition releases.

LED connection

The RT9379 supports up to 6 white LEDs. The 6 LEDs are connected from VIN to pin1, 2, 3, 14, 15 and 16 respectively. If the LED is not used, the LED pin should be connected to VIN directly.

Capacitors Selection

To get the better performance of the RT9379, the selection of peripherally appropriate capacitor and value is very important. These capacitors determine some parameters such as input/output ripple voltage, power efficiency and maximum supply current by charge pump. To reduce the input and output ripple effectively, the low ESR ceramic capacitors are recommended. For LED driver applications, the input voltage ripple is more important than output ripple. Input ripple is controlled by input capacitor C_{IN} , increasing the value of input capacitance can further reduce the ripple. Practically, the input voltage ripple depends on the power supply impedance. The flying capacitor C_{FLY1} and C_{FLY2} determine the supply current capability of the charge pump to influence the overall efficiency of the system. The lower value will improve efficiency. However, it will limit the LED's current at low input voltage. For 6 X25mA load over the entire input range of 2.8V to 4.5V, it is recommended to use a 1uF ceramic capacitor on the flying capacitor C_{FLY1} and C_{FLY2} .

Brightness Control

The RT9379 implements a PWM dimming method to control the brightness of white LEDs. When an external PWM signal is connected to the EN pin, brightness of white LED is adjusted by the duty cycle. The suggested PWM dimming frequency range is from 1kHz to 200kHz.

Thermal Considerations

For continuous operation, do not exceed absolute maximum operation junction temperature. The maximum power dissipation depends on the thermal resistance of IC package, PCB layout, the rate of surroundings airflow and temperature difference between junction to ambient. The maximum power dissipation can be calculated by following formula :

$$P_{D(MAX)} = (T_{J(MAX)} - T_A) / \theta_{JA}$$

Where $T_{J(MAX)}$ is the maximum operation junction temperature, T_A is the ambient temperature and the θ_{JA} is the junction to ambient thermal resistance.

For recommended operating conditions specification of

the RT9379, The maximum junction temperature is 125°C. The junction to ambient thermal resistance θ_{JA} is layout dependent. For WQFN-16L 2x3 package, the thermal resistance θ_{JA} is 90°C/W on the standard JEDEC 51-7 four layers thermal test board. The maximum power dissipation at $T_A = 25^\circ\text{C}$ can be calculated by following formula :

$$P_{D(\text{MAX})} = (125^\circ\text{C} - 25^\circ\text{C}) / (90^\circ\text{C/W}) = 1.111\text{W for WQFN-16L 2x3 package}$$

The maximum power dissipation depends on operating ambient temperature for fixed $T_{J(\text{MAX})}$ and thermal resistance θ_{JA} . For RT9379 package, the Figure 1 of derating curve allows the designer to see the effect of rising ambient temperature on the maximum power dissipation allowed.

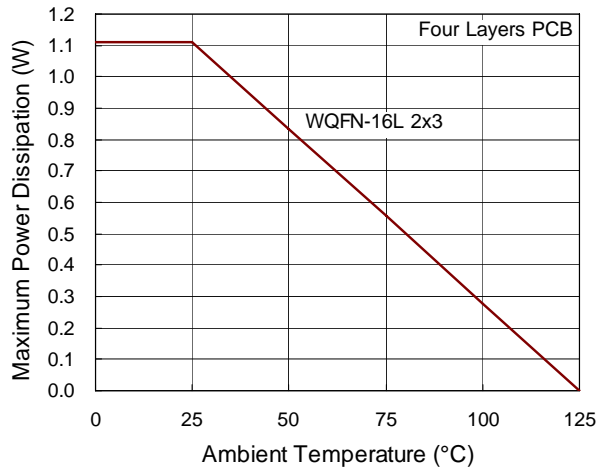

Figure 1. Derating Curve for RT9379 Package

Layout Considerations

For best performance of the RT9379, the following layout guidelines should be strictly followed :

- ▶ Output Capacitor (C_{OUT}) should be placed close to VOUT and connected to ground plane to reduce noise coupling from charge pump to LEDs.
- ▶ All the traces of LED pins running from chip to LED's should be wide and short to reduce the parasitic connection resistance.
- ▶ The trace from CF pin to external capacitance should be as short as possible.

- ▶ Input capacitor (C_{IN}) should be placed close to VIN and connected to ground plane. The trace of VIN in the PCB should be placed far away from the sensitive devices or shielded by the ground.
- ▶ The traces running from pins to flying capacitor should be short and wide to reduce parasitic resistance and prevent noise radiation.

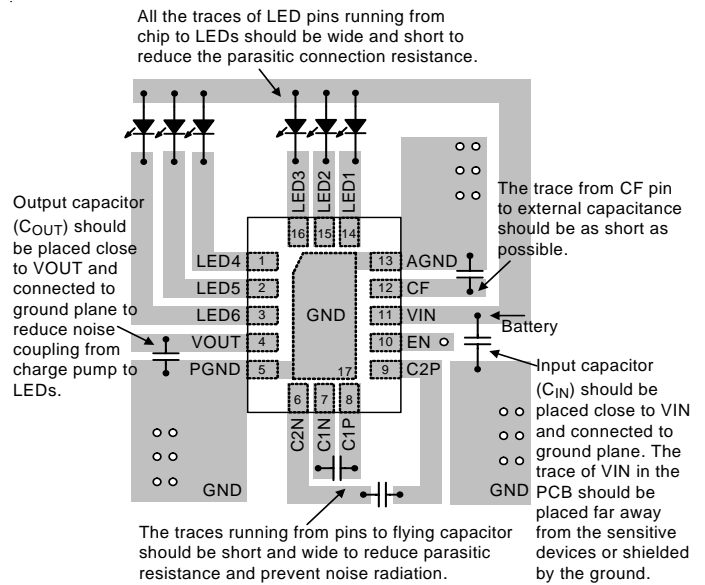
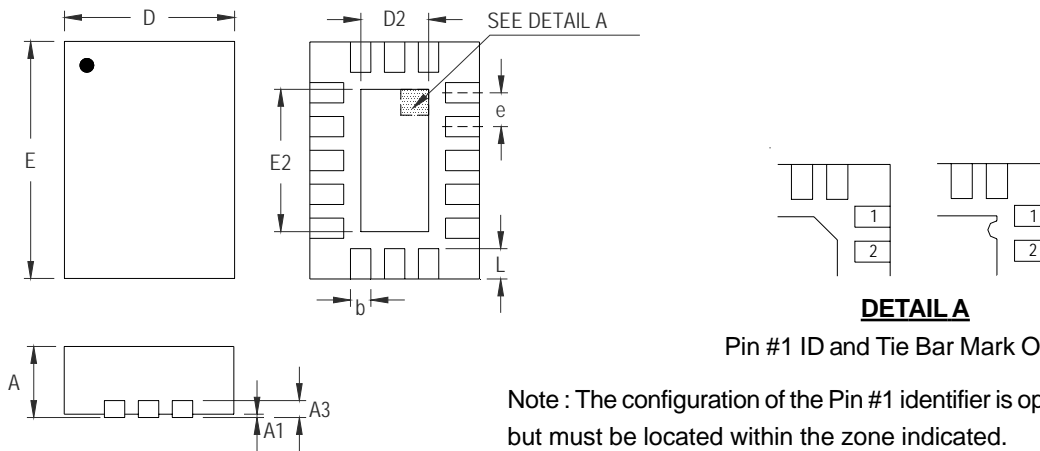

Figure 2. PCB Layout Guide

Outline Dimension



Pin #1 ID and Tie Bar Mark Options

Note : The configuration of the Pin #1 identifier is optional, but must be located within the zone indicated.

Symbol	Dimensions In Millimeters		Dimensions In Inches	
	Min	Max	Min	Max
A	0.700	0.800	0.028	0.031
A1	0.000	0.050	0.000	0.002
A3	0.175	0.250	0.007	0.010
b	0.150	0.250	0.006	0.010
D	1.900	2.100	0.075	0.083
D2	0.700	0.800	0.028	0.031
E	2.900	3.100	0.114	0.122
E2	1.700	1.800	0.067	0.071
e	0.400		0.016	
L	0.325	0.425	0.013	0.017

W-Type 16L QFN 2x3 Package

Richtek Technology Corporation

Headquarter
5F, No. 20, Taiyuen Street, Chupei City
Hsinchu, Taiwan, R.O.C.
Tel: (8863)5526789 Fax: (8863)5526611

Richtek Technology Corporation

Taipei Office (Marketing)
5F, No. 95, Minchiuan Road, Hsintien City
Taipei County, Taiwan, R.O.C.
Tel: (8862)86672399 Fax: (8862)86672377
Email: marketing@richtek.com

Information that is provided by Richtek Technology Corporation is believed to be accurate and reliable. Richtek reserves the right to make any change in circuit design, specification or other related things if necessary without notice at any time. No third party intellectual property infringement of the applications should be guaranteed by users when integrating Richtek products into any application. No legal responsibility for any said applications is assumed by Richtek.