

## 3 Channels 90mA x1/x2 Charge Pump White LED Driver

### General Description

The RT9363A is a compact, high efficient and highly integrated charge pump white LED driver. It maintains the highest efficiency by utilizing a x1/x2 fractional charge pump and low dropout current regulators. The RT9363A supports up to 3 white LEDs and regulates a constant current for uniform intensity. The part implements a 4-bit DAC for brightness control. Users can select external R<sub>SET</sub> or internal R<sub>SET</sub> by ISET pin. The dimming of white LEDs' current can be achieved by applying a pulse signal to the EN pin. There are totally 16 steps of current could be set by users. The part can support 15mA to 30mA for the 100% current setting. Users also can use the internal R<sub>SET</sub> for 100% current setting of 20mA just by connecting the ISET pin to V<sub>IN</sub>. The operating voltage range is from 2.8V to 5.5V. Internal soft start circuitry effectively reduces the in-rush current while both start-up and mode transition. The load is disconnected from V<sub>IN</sub> while shutdown and the shutdown current is less than 1uA.

RT9363A is available in a WDFN -10L 3x3 package.

### Ordering Information

RT9363A □ □

- Package Type  
QW : WDFN-10L 3x3 (W-Type)
- Lead Plating System  
P : Pb Free  
G : Green (Halogen Free and Pb Free)

Note :

Richtek products are :

- ▶ RoHS compliant and compatible with the current requirements of IPC/JEDEC J-STD-020.
- ▶ Suitable for use in SnPb or Pb-free soldering processes.

### Marking Information

For marking information, contact our sales representative directly or through a Richtek distributor located in your area.

### Features

- Over 80% Average Efficiency Over Battery Life
- Support Up to 3 White LEDs
- 80mV Typical Current Source Dropout
- Support Up to 90mA Output Current
- 1% Typical LED Current Accuracy
- 0.7% Typical LED Current Matching
- Soft Start Function
- Automatic Charge Pump Mode Selection
- 1MHz Random Frequency Oscillator
- Over Voltage Protection
- 16-Step Brightness Control
- Low Input Noise and EMI
- Low 1uA Shutdown Current
- Flexible Current Setting
- RoHS Compliant and 100% Lead (Pb)-Free

### Applications

- Mobile Phone, DSC, MP3
- White LED Backlighting
- LCD Display Supply

### Pin Configurations

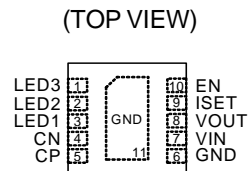

WDFN-10L 3x3

## Typical Application Circuit

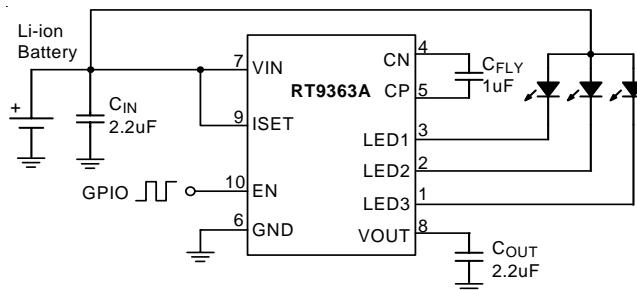

Figure 1. Internal  $R_{SET(MAX)} = 20mA$ , for 3-WLEDs Application Circuit

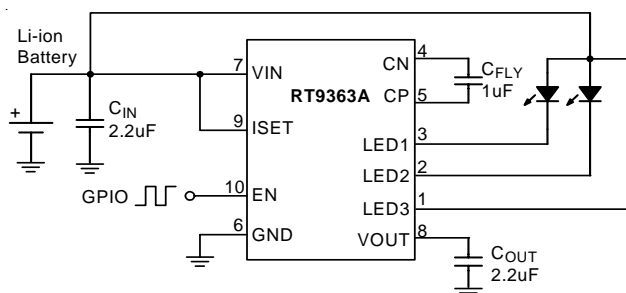

Figure 2. Internal  $R_{SET(MAX)} = 20mA$ , for 2-WLEDs Application Circuit

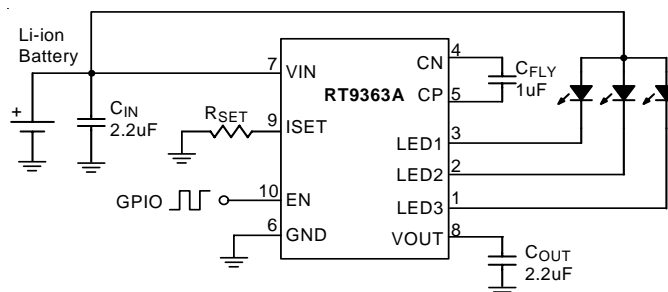

Figure 3. External  $R_{SET(MAX)} = 15$  to  $30mA$ , for 3-WLEDs Application Circuit

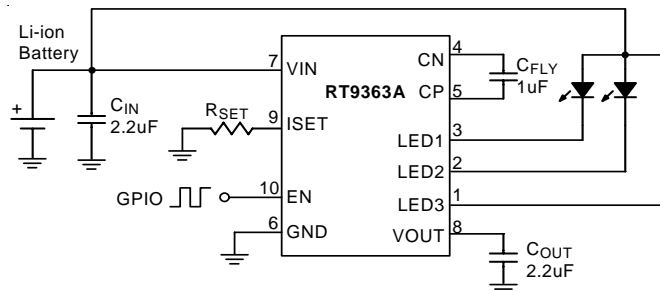

Figure 4. External  $R_{SET(MAX)} = 15$  to  $30mA$ , for 2-WLEDs Application Circuit

**Timing Diagram**

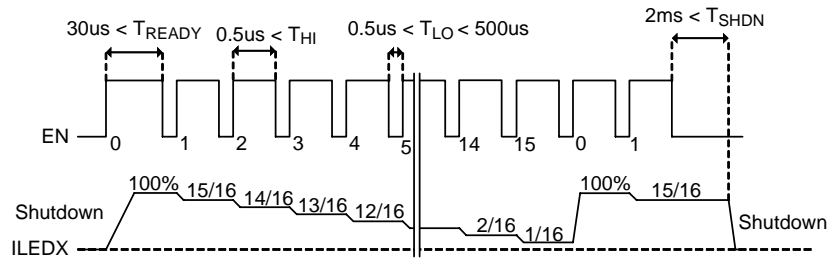
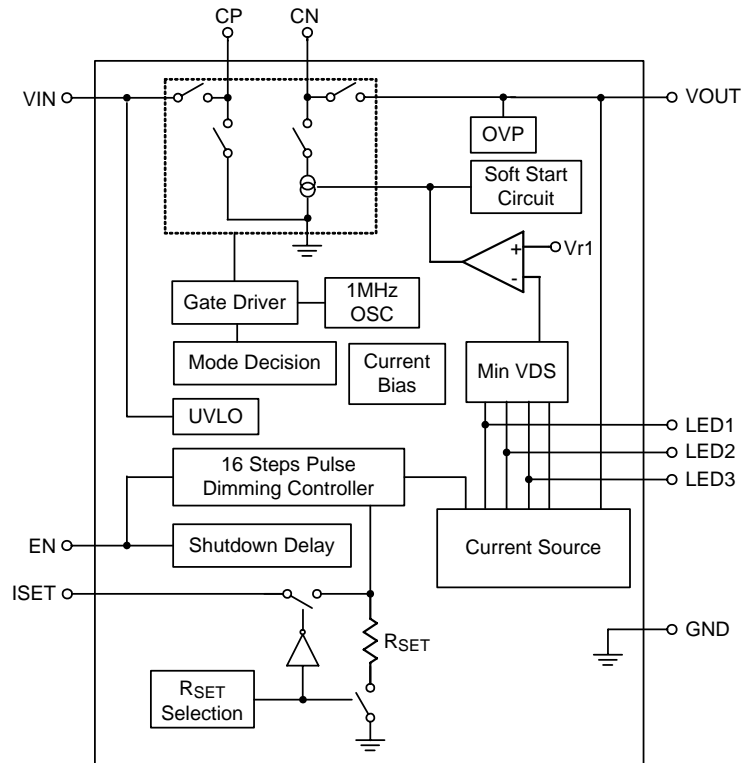

Figure 5. Pulse Dimming Waveform

**Functional Pin Description**

Pin No.	Pin Name	Pin Function
1	LED3	Current Sink for LED3. (If not in use, this pin must be connected to $V_{IN}$ ).
2	LED2	Current Sink for LED2. (If not in use, this pin must be connected to $V_{IN}$ ).
3	LED1	Current Sink for LED1. (If not in use, this pin must be connected to $V_{IN}$ ).
4	CN	Negative Terminal of Bucket Capacitor.
5	CP	Positive Terminal of Bucket Capacitor.
6, 11 (Exposed Pad)	GND	Ground. The exposed pad must be soldered to a large PCB and connected to GND for maximum power dissipation.
7	VIN	Input Voltage.
8	VOUT	Output Voltage Source for LED1~3.
9	ISET	LED Current Adjust Input.
10	EN	Chip Enable (Active High).

Function Block Diagram



**Absolute Maximum Ratings** (Note 1)

- Supply Input Voltage ----- -0.3V to 6V
- Output Voltages ----- -0.3V to 6V
- Power Dissipation,  $P_D$  @  $T_A = 25^\circ\text{C}$   
 WDFN 10L 3x3 ----- 1.538W
- Package Thermal Resistance (Note 2)  
 WDFN 10L 3x3,  $\theta_{JA}$  -----  $60^\circ\text{C/W}$   
 WDFN 10L 3x3,  $\theta_{JC}$  -----  $8.2^\circ\text{C/W}$
- Junction Temperature -----  $150^\circ\text{C}$
- Lead Temperature (Soldering, 10 sec.) -----  $260^\circ\text{C}$
- Storage Temperature Range -----  $-65^\circ\text{C}$  to  $150^\circ\text{C}$
- ESD Susceptibility (Note 3)  
 HBM (Human Body Mode) ----- 2kV  
 MM (Machine Mode) ----- 200V

**Recommended Operating Conditions** (Note 4)

- Junction Temperature Range -----  $-40^\circ\text{C}$  to  $125^\circ\text{C}$
- Ambient Temperature Range -----  $-40^\circ\text{C}$  to  $85^\circ\text{C}$

**Electrical Characteristics**

( $V_{IN} = 3.6\text{V}$ ,  $C_{IN} = C_{OUT} = 2.2\mu\text{F}$ ,  $C_{FLY} = 1\mu\text{F}$ ,  $V_F = 3.5\text{V}$ ,  $I_{LED1} = I_{LED2} = I_{LED3} = 20\text{mA}$ ,  $\text{ESR} = 0.03\Omega$ ,  $T_A = 25^\circ\text{C}$ , unless otherwise specified).

Parameter	Symbol	Test Conditions	Min	Typ	Max	Unit
<b>Input Power Supply</b>						
Input Supply Voltage	$V_{IN}$		2.8	--	5.5	V
Under Voltage Lockout Threshold	$V_{UVLO\_R}$		--	--	2.4	V
	$V_{UVLO\_F}$		1.8	--	--	mV
Quiescent Current of x1 Mode	$I_{Qx1}$	x1 Mode(LED1~3 connect to $V_{IN}$ )	--	1	--	mA
Quiescent Current of x2 Mode	$I_{Qx2}$	X2 Mode No Load	--	3	--	mA
Shutdown Current	$I_{SHDN}$	EN = 0V, $V_{IN} = 5\text{V}$	--	1	11	$\mu\text{A}$
<b>LED Current</b>						
$I_{LED}$ Accuracy	$I_{LED\_ERR}$	100% Setting	-8	--	+8	%
Current Matching	$I_{LED\_LED\_ERR}$	100% Setting	-5	--	+5	%
<b>Charge Pump</b>						
Oscillator Frequency	$F_{OSC}$		--	1000	--	kHz
x1 mode to x2 mode Transition Voltage	$V_{TS}$	$V_F = 3.5\text{V}$ , $I_{OUT} = 60\text{mA}$ $V_{IN}$ Falling	--	3.6	--	V
<b>Protection</b>						
Over Voltage Protection	$V_{OVP}$	Open Circuit at any LED Pin	--	5.5	--	V

*To be continued*

Parameter	Symbol	Test Conditions	Min	Typ	Max	Unit
<b>Digital Input</b>						
EN Threshold Voltage	Logic-High	V <sub>EN_H</sub>	1.5	--	--	V
	Logic-Low	V <sub>EN_L</sub>	--	--	0.4	
EN Current	Logic-High	I <sub>EN_H</sub>	V <sub>EN</sub> = V <sub>IN</sub>	--	1	uA
	Logic-Low	I <sub>EN_L</sub>	V <sub>EN</sub> = 0V	--	0.1	
EN Low to Shutdown Delay	T <sub>SHDN</sub>	Refer to Figure 5	2	--	--	ms
EN High Time for Dimming	T <sub>HI</sub>	Refer to Figure 5	0.5	--	--	us
EN High Time for Holding	T <sub>LO</sub>	Refer to Figure 5	0.5	--	500	us

**Note 1.** Stresses listed as the above "Absolute Maximum Ratings" may cause permanent damage to the device. These are for stress ratings. Functional operation of the device at these or any other conditions beyond those indicated in the operational sections of the specifications is not implied. Exposure to absolute maximum rating conditions for extended periods may remain possibility to affect device reliability.

**Note 2.**  $\theta_{JA}$  is measured in the natural convection at T<sub>A</sub> = 25°C on the high effective thermal conductivity four layers thermal test board of JEDEC 51-7 thermal measurement standard. The case point of  $\theta_{JC}$  is on the expose pad.

**Note 3.** Devices are ESD sensitive. Handling precaution is recommended.

**Note 4.** The device is not guaranteed to function outside its operating conditions.

**Typical Operating Characteristics**

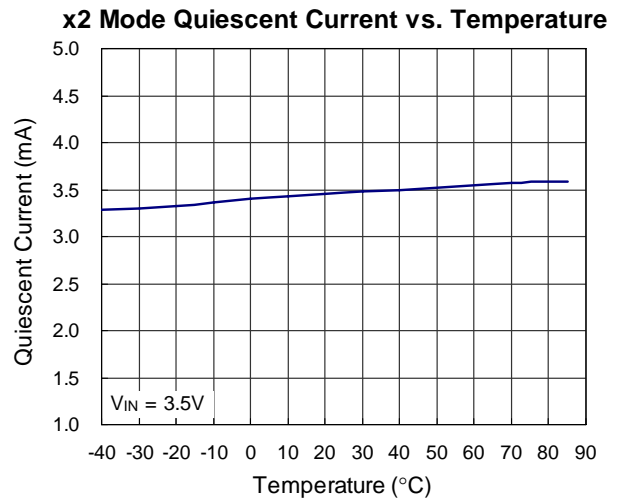
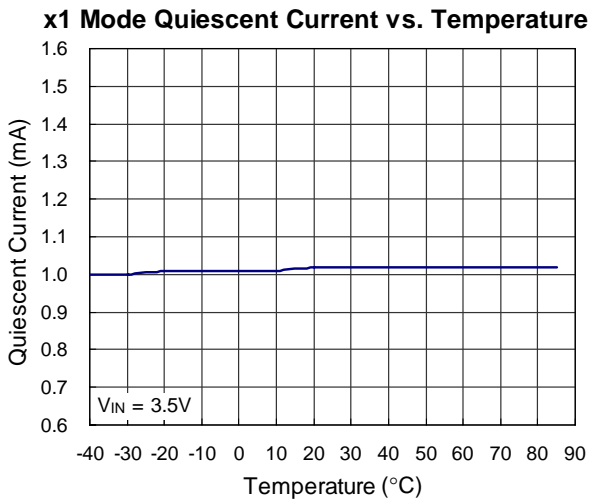
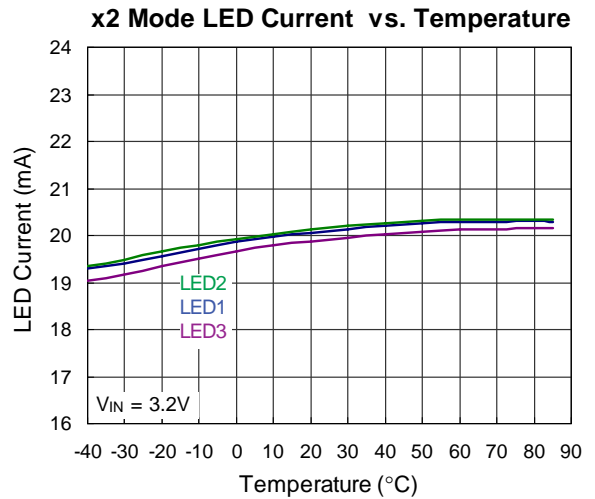
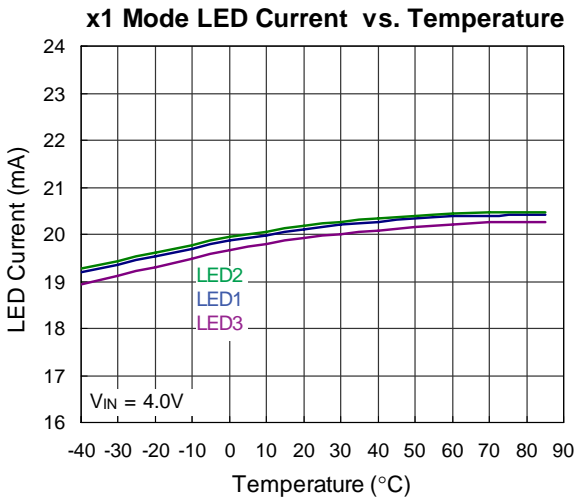
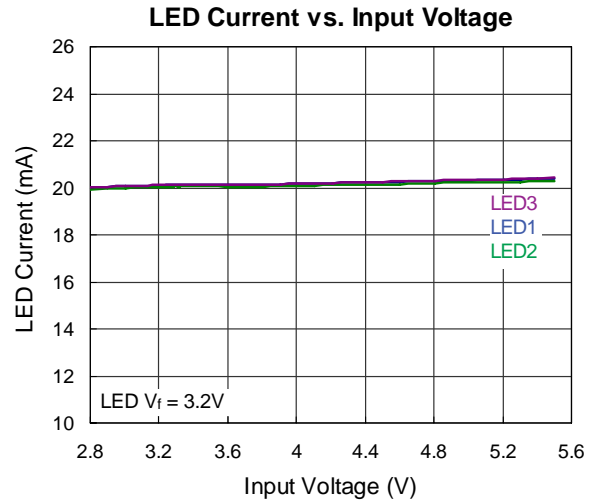
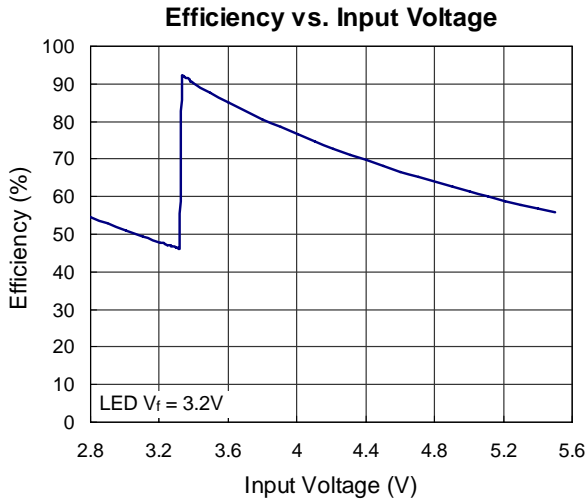

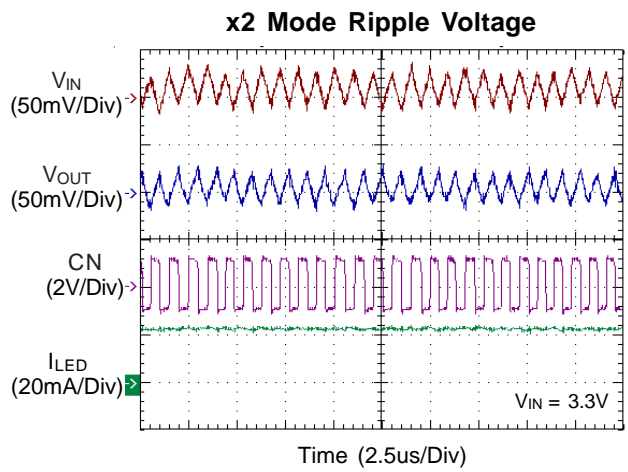
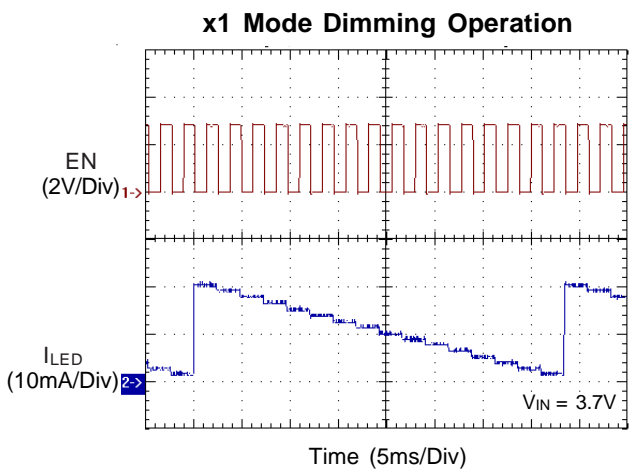
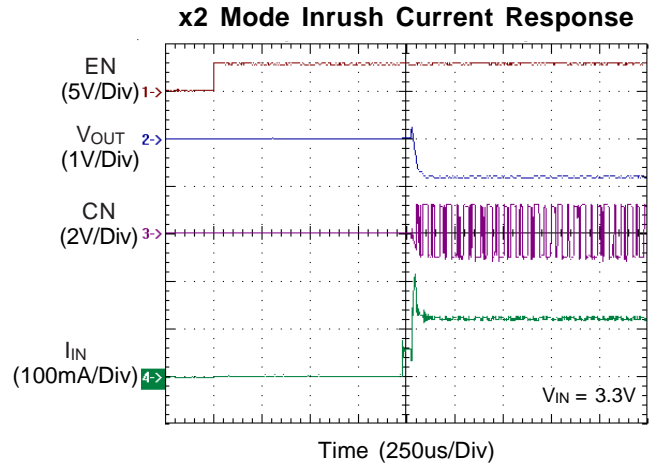
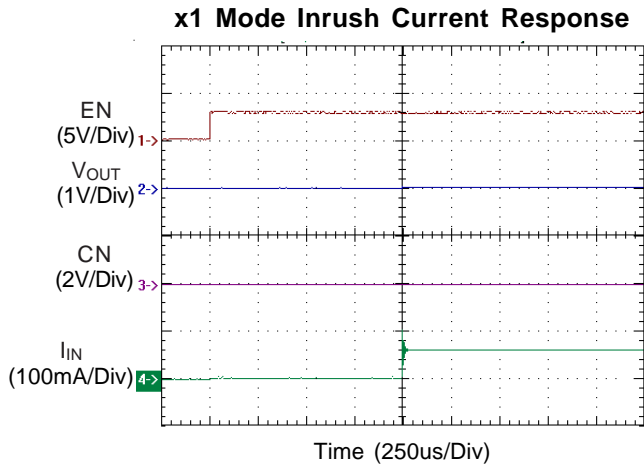
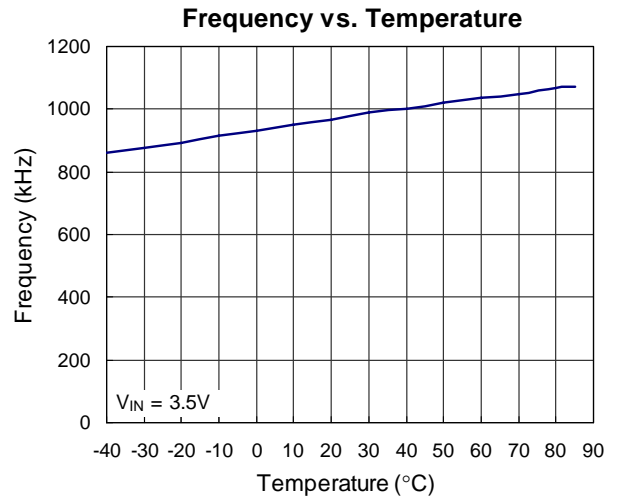
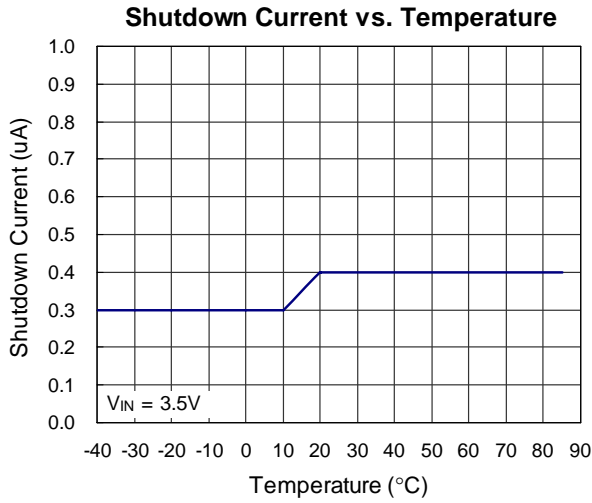



**Application information**

The RT9363A uses a fractional switched capacitor charge pump to power up to three white LEDs with a programmable current. The part integrates current sources and automatic mode selection charge pump. It maintains the high efficiency by utilizing an x1/x2 fractional charge pump and current sources. The small equivalent x1 mode open loop resistance and ultra-low dropout voltage of current source extend the operating time of x1 mode and optimize the efficiency in white LED applications. The operating voltage range is from 2.8V to 5.5V. Internal soft start circuitry effectively reduces the in-rush current while both start-up and mode transition. The load is disconnected from V<sub>IN</sub> while shutdown and the shutdown current is less than 1uA.

**High Efficiency x1/x2 Charge Pump**

Before the discussion of efficiency in RT9363A, two things need to be illustrated. One is the Li-ion battery life time, the other is the forward voltage of white LED. The Li-ion battery energy is not linearly proportion to battery voltage. In the Figure 6, It shows the 80% battery life of Li-ion is arranged from 3.65V to 4.0V. The other voltage range occupies less than 20% battery energy and is insignificant. In the backlight application, the forward voltage of white LEDs most likely falls in 3.2 to 3.5V @ I<sub>LED</sub> = 20mA. The developing concept of RT9363 is based on the backlight application with Li-ion battery. RT9363A is very cost-effective product for white LEDs backlight driving. It extends the 80% battery life by the reduction of open loop resistance at x1 mode and current source drop out voltage. Figure 7 is the efficiency diagram of RT9363 and 80% battery life is marked by red rectangle. The RT9363A maximize the x1 mode operating range in the 80% battery life. Therefore, the efficiency is not significant different to that without x1.5 mode charge pump. The peak efficiency of RT9363A is 93% and the average is 84%. Comparing to the LED drivers with x1.5 mode, only 1 to 2% efficiency loss by x2 mode. (Assume 5% battery life in charge pump mode and the efficiency difference of x1.5 and x2 modes is 25%, the efficiency loss thus is 5%x25% = 1.25%).

**Protection**

The RT9363A includes a soft start circuit to limit the inrush current at power on and mode transition.

Soft start circuit holds the input current level long enough for output capacitor C<sub>OUT</sub> reaching a desired voltage level. When the soft start off, the RT9363A won't sink spike current from V<sub>IN</sub>. An over voltage protection function protect the output voltage from dangerous high voltage. The OVP turns off charge pump when the voltage difference between V<sub>IN</sub> and V<sub>OUT</sub> is over the designed target.

**LED Current Setting**

In Backlighting part, an internal R<sub>SET</sub> is used to set the initial current (20mA) of white LED and implements a 4-bit DAC for brightness control. Users can easily configure the LED current by a serial pulse. The dimming of white LEDs' current can be achieved by applying a pulse signal to the EN pin. There are totally 16 steps of current could be set by users. An automatic R<sub>SET</sub> selection is implemented in this part. RT9363A can automatically select the internal or external R<sub>SETs</sub> by the connection of ISET pin. The LED current can be calculated by the following equation.

$$I_{LED} = 276 \left( \frac{V_{SET}}{R_{SET}} \right)$$

where V<sub>SET</sub> = 1.1V (typ.) and R<sub>SET</sub> is the external resistor connected from ISET pin to GND.

**LED Current Setting Table**

R <sub>SET</sub>	LED current (mA)
10k	30.3
12.1k	25.1
15k	20.2
20k	15.2
30.1k	10.1

## Typical Operation

As shown in the typical application circuit, the power of the RT9363A is provided from the external adapter or battery. When EN pin is low, the white LED for backlighting is turned off and draws a very low current from battery supply.

When EN pin is high, RT9363A provides a twice mode load switch (x1) and high efficiency (x2) charge pump device intended for white LED backlight applications. To maximize the power conversion efficiency, an internal sensing circuit monitors the voltage required on each constant sink input and sets the load switch and charge pump modes based on the input battery voltage and the current sink input voltage. RT9363A provides the option to control the 16-steps brightness of white LEDs with a digital pulse signal applied to EN pin and the detailed timing of pulse dimming is shown in Figure 5.

## Capacitors Selection

To get the better performance of RT9363A, the selection of peripherally appropriate capacitor and value is very important. These capacitors determine some parameters such as input and output ripple, power efficiency, maximum supply current by charge pump, and start-up time.

To reduce the input and output ripple effectively, the low ESR ceramic capacitors are recommended. Generally, to reduce the output ripple, increasing the output capacitance  $C_{OUT}$  is necessary. However, this will increase the start-up time of output voltage. For LED driver applications, the input voltage ripple is more important than the output ripple. Input ripple is controlled by input capacitor  $C_{IN}$ , increasing the value of input capacitance can further reduce the ripple. Practically, the input voltage ripple depends on the power supply's impedance. Tantalum capacitors are not recommended for the RT9363A. If tantalum must capacitors are needed,  $C_{IN}$  and  $C_{FLY}$  must larger than  $10\mu F$  and  $1\mu F$ . Because tantalum capacitors' values are less than normal when using for high frequency applications. So tantalum capacitor values and ceramic capacitor values can't be the same. But  $C_{OUT}$  can't use tantalum capacitor, because during the x2 mode charge pump the  $V_{OUT}$  is negative voltage.

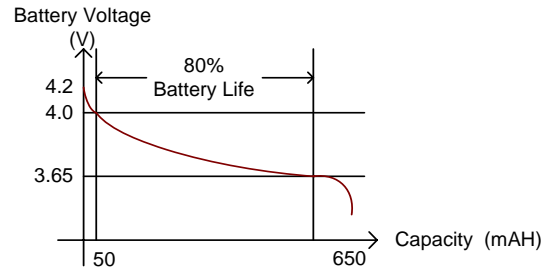

Figure 6. Li-ion Battery Energy Capacity Versus Battery Voltage.

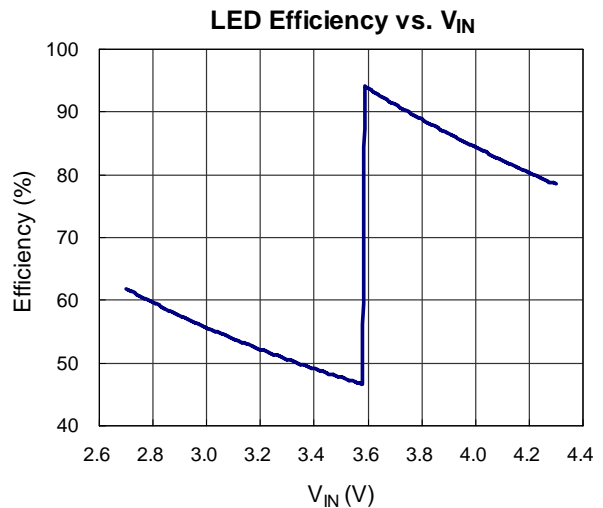

Figure 7. Efficiency of RT9363A. ( $I_{LED} = 60mA$ ,  $V_F = 3.5V$ )

## PCB Board Layout

All the traces of LED and VIN running from chip to LEDs should be wide and short to reduce the parasitic connection resistance and shielded, isolated by ground plane. The Anodes of LEDs must connect to  $C_{IN}$ , not battery directly.

Output capacitor must be placed close to the  $V_{OUT}$  and connect to GND plane.

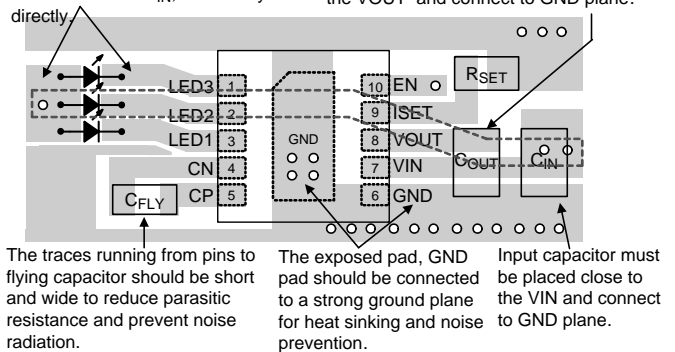
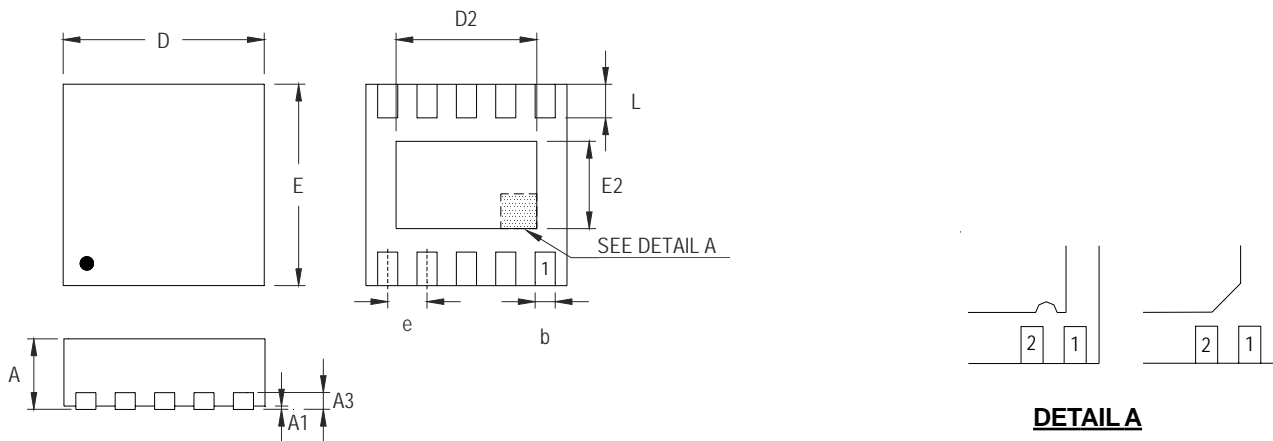

Figure 8. PCB Layout Guide

**Outline Dimension**



**DETAIL A**

Pin #1 ID and Tie Bar Mark Options

Note : The configuration of the Pin #1 identifier is optional, but must be located within the zone indicated.

Symbol	Dimensions In Millimeters		Dimensions In Inches	
	Min	Max	Min	Max
A	0.700	0.800	0.028	0.031
A1	0.000	0.050	0.000	0.002
A3	0.175	0.250	0.007	0.010
b	0.180	0.300	0.007	0.012
D	2.950	3.050	0.116	0.120
D2	2.300	2.650	0.091	0.104
E	2.950	3.050	0.116	0.120
E2	1.500	1.750	0.059	0.069
e	0.500		0.020	
L	0.350	0.450	0.014	0.018

**W-Type 10L DFN 3x3 Package**

**Richtek Technology Corporation**

Headquarter  
 5F, No. 20, Taiyuen Street, Chupei City  
 Hsinchu, Taiwan, R.O.C.  
 Tel: (8863)5526789 Fax: (8863)5526611

**Richtek Technology Corporation**

Taipei Office (Marketing)  
 5F, No. 95, Minchiuan Road, Hsintien City  
 Taipei County, Taiwan, R.O.C.  
 Tel: (8862)86672399 Fax: (8862)86672377  
 Email: marketing@richtek.com

Information that is provided by Richtek Technology Corporation is believed to be accurate and reliable. Richtek reserves the right to make any change in circuit design, specification or other related things if necessary without notice at any time. No third party intellectual property infringement of the applications should be guaranteed by users when integrating Richtek products into any application. No legal responsibility for any said applications is assumed by Richtek.