

DETAIL A

PATENT PEND

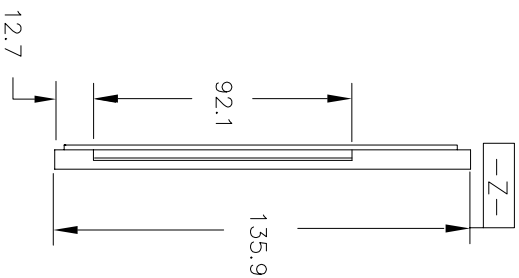

- NOTES :
1. MATERIAL - Ppb.
 2. ALL DIMENSIONS ARE IN MILLIMETERS.
 3. TOLERANCES - X.XX=±0.25
- XXX=±0.13
- UNLESS OTHERWISE SPECIFIED.
4. ESD - SURFACE RESISTIVITY
- 105 TO 10¹¹ OHMS/SQ.
 5. FOR PACKAGE - PBGA
 6. PART NO. : NX BG3535 2.2 0308 6 REV.A (PLEASE INDICATE ON PURCHASE ORDER).

11	P-00806	CHANGE SURFACE RESISTIVITY	2 FEB 99
10	P-00682	CHANGE POSITION TOL	18 OCT 97
9	P-00592	CHANGE DIMS	18 MAR 97
8	P-00569	CHANGE BOTTOM TENG DIM IN DRAWING	8 JUL 96
7	P-00558	ADD IN MATERIAL PPG	17 OCT 95
6	P-00536	ADD IN TRAY GATE LOCATION	13 JUN 95
REVNO.	ECN #	DESCRIPTION	DATE

DRAWN BY :	Wang	PAGE 1 OF 2
CHECKED BY :		DATE : 2 FEB 99
APPROVED BY :		DATE : 2 FEB 99
DO NOT SCALE DRAWING		DATE : 2 FEB 99
		CODE : CSA00688

CUSTOMER :	PEAK
TITLE :	NX BG3535 2.2 0308 6 REV.A
DWG NO.:	NX BG3535 2.2 0308 6 REV.A
REV.	11



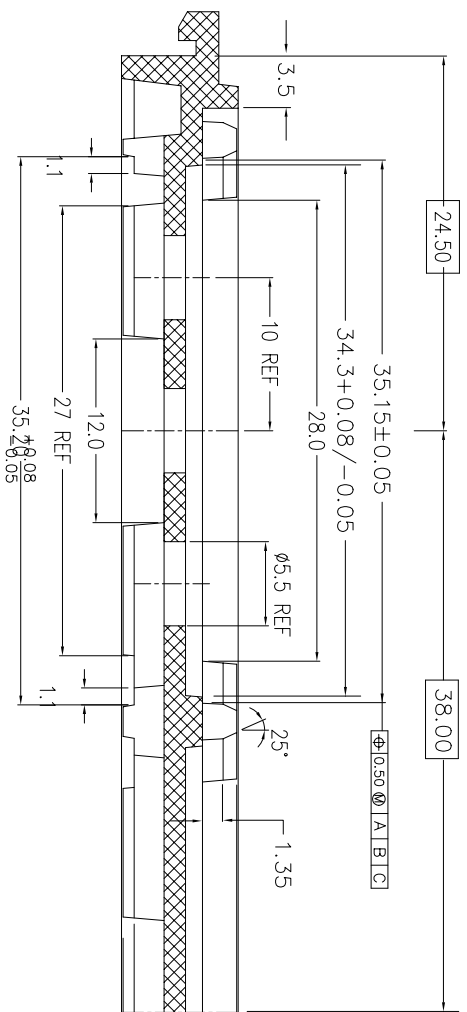

SECTION A-A

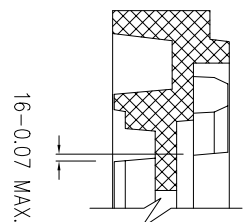

SECTION D-D

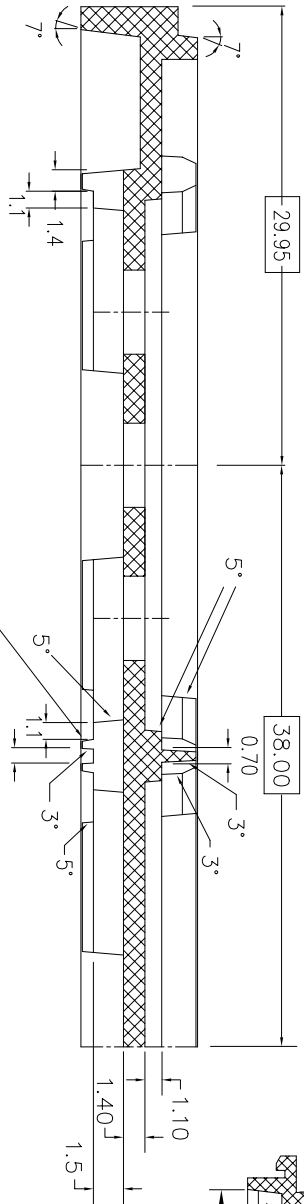

SECTION B-B

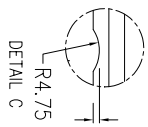

NOTE: SCALLOP IS CENTERED ON SIDE OF TRAY

SECTION H-H

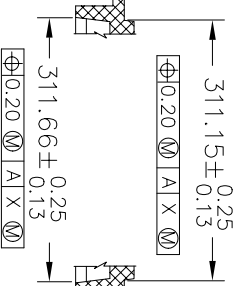

SECTION J-J

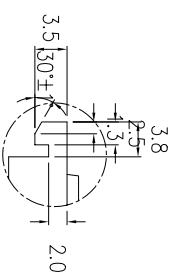
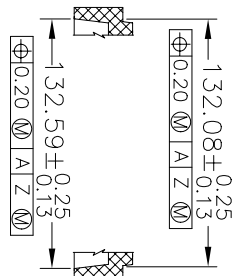

DETAIL D

PATENT PEND

11	P-00806	CHANGE SURFACE RESISTIVITY	2 FEB 99
10	P-00662	CHANGE POSITION TOL	18 OCT 97
9	P-00592	CHANGE DIMS	18 MAR 97
8	P-00569	CHANGE BOTTOM FENCE DIM IN DRAWING	8 JUL 96
7	P-00558	ADD IN MATERIAL PPG	17 OCT 95
6	P-00536	ADD IN TRAY GATE LOCATION	13 JUN 95
REV. NO.	ECN #	DESCRIPTION	DATE

<p>THIS DOCUMENT CONTAINS INFORMATION PROPRIETARY TO PEAK PLASTIC & METAL PRODUCTS INTERNATIONAL LIMITED. REPRODUCTION DISCLOSURE OR USE OF THIS DOCUMENT IS EXPRESSLY PROHIBITED EXCEPT OTHERWISE AGREED UPON IN WRITING.</p>	<p>DRAWN BY : WANG</p> <p>CHECKED BY :</p> <p>APPROVED BY :</p> <p>DO NOT SCALE DRAWING</p>
--	---

PAGE 2 OF 2	CUSTOMER : PEAK
DATE : 2 FEB 99	TITLE : NX BG3535 2.2 0308 6 REV.A
DATE : 2 FEB 99	DWG NO. : NX BG3535 2.2 0308 6 REV.A
DATE : 2 FEB 99	REV. 11

