

Features

- 3.0mmx1.5mm SMT LED, 1.4mm THICKNESS.
- LOW POWER CONSUMPTION.
- WIDE VIEWING ANGLE.
- IDEAL FOR BACKLIGHT AND INDICATOR.
- VARIOUS COLORS AND LENS TYPES AVAILABLE.
- PACKAGE : 2000PCS / REEL.
- MOISTURE SENSITIVITY LEVEL : LEVEL 3.
- RoHS COMPLIANT.



Notes:

1. All dimensions are in millimeters (inches).
2. Tolerance is $\pm 0.20(0.008")$ unless otherwise noted.
3. Specifications are subject to change without notice.

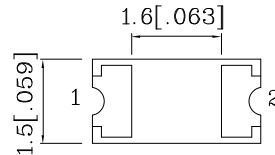
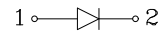
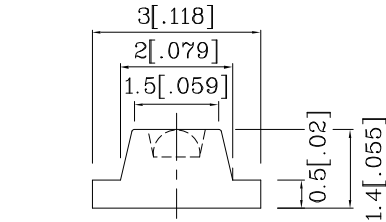
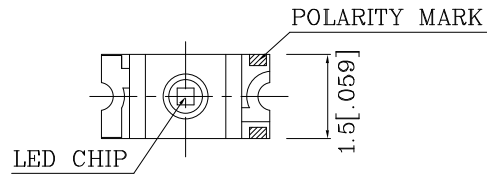

Absolute maximum ratings (TA=25°C)		MO (InGaAlP)	Unit
Reverse Voltage	V _R	5	V
Forward Current	I _F	30	mA
Forward Current (Peak) 1/10 Duty Cycle 0.1ms Pulse Width	i _{FS}	195	mA
Power Dissipation	P _T	75	mW
Operating Temperature	T _A	-40 ~ +85	°C
Storage Temperature	T _{stg}	-40 ~ +85	

Operating Characteristics (TA=25°C)		MO (InGaAlP)	Unit
Forward Voltage (Typ.) (I _F =20mA)	V _F	2.0	V
Forward Voltage (Max.) (I _F =20mA)	V _F	2.5	V
Reverse Current (Max.) (V _R =5V)	I _R	10	uA
Wavelength of Peak Emission (Typ.) (I _F =20mA)	λ P	610	nm
Wavelength of Dominant Emission (Typ.) (I _F =20mA)	λ D	601	nm
Spectral Line Full Width At Half-Maximum (Typ.) (I _F =20mA)	Δλ	29	nm
Capacitance (Typ.) (V _F =0V, f=1MHz)	C	30	pF

Part Number	Emitting Color	Emitting Material	Lens-color	Luminous Intensity (I _F =20mA) mcd		Wavelength nm λ P	Viewing Angle 2 θ 1/2
				min.	typ.		
ZMO60W	Orange	InGaAlP	Water Clear	180	497	610	70°

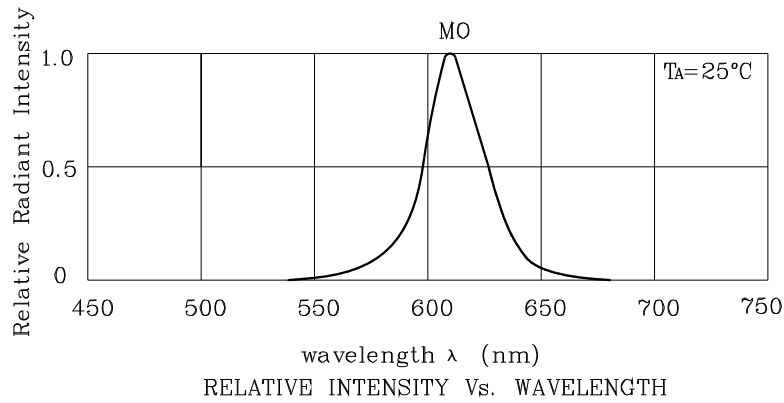

❖ MO

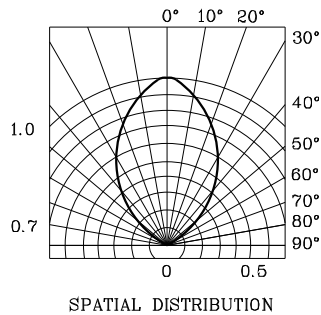
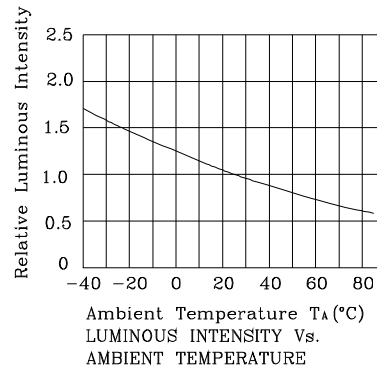
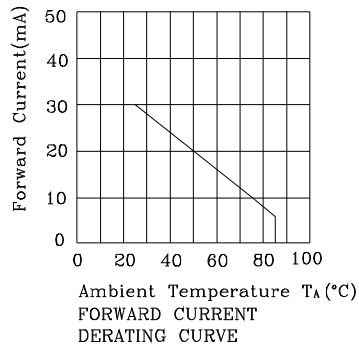
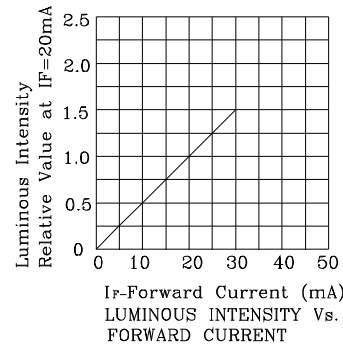
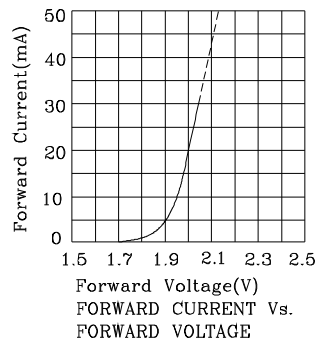

Reflow Soldering Profile For Lead-free SMT Process.

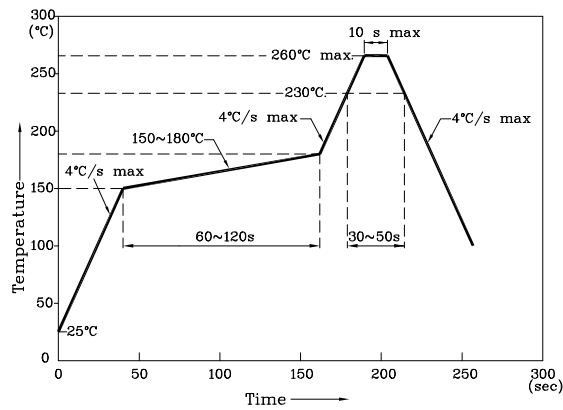

NOTES:

1. Maximum soldering temperature should not exceed 260°C.
2. Recommended reflow temperature: 145°C–260°C.
3. Do not put stress to the epoxy resin during high temperatures conditions.

❖ Recommended Soldering Pattern
(Units : mm; Tolerance: ± 0.1)

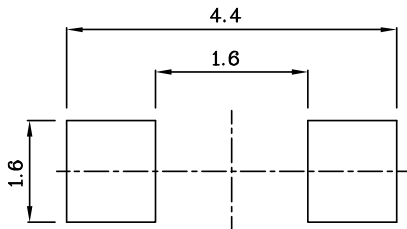

❖ The device has a single mounting surface. The device must be mounted according to the specifications.

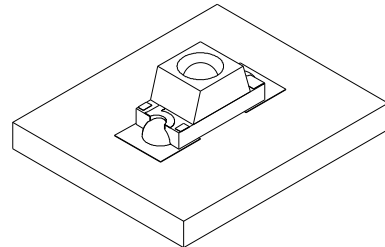

❖ Tape Specification (Units : mm)

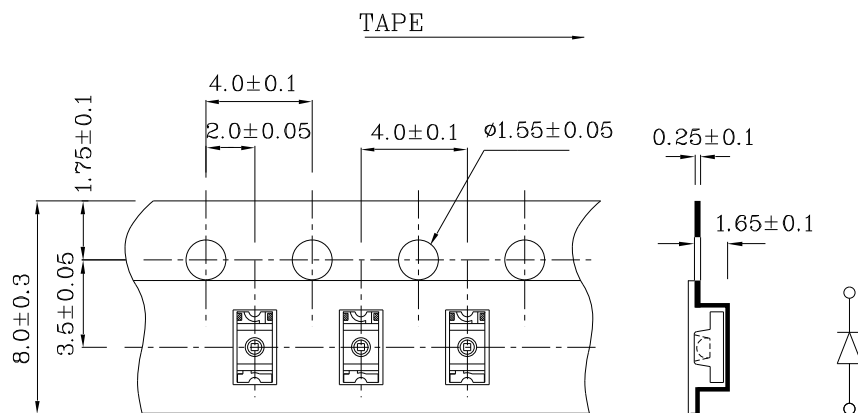

Remarks:



If special sorting is required (e.g. binning based on forward voltage, Luminous intensity / luminous flux, or wavelength), the typical accuracy of the sorting process is as follows:



1. Wavelength: +/-1nm
2. Luminous intensity / luminous flux: +/-15%
3. Forward Voltage: +/-0.1V

Note: Accuracy may depend on the sorting parameters.

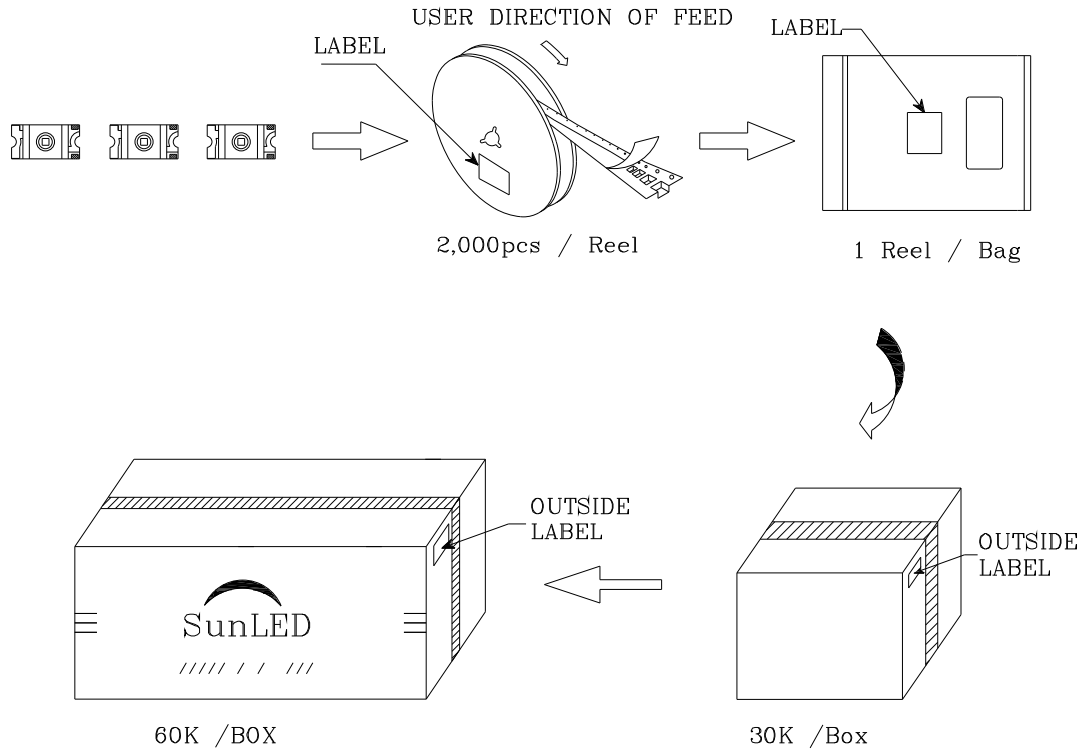
PACKING & LABEL SPECIFICATIONS

ZMO60W

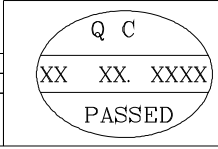
	
P/NO : Zxx60x	
QTY : 2,000 pcs	CODE: XXX
S/N : XX	
LOT NO:	
 XXXXXXXXXXXXXXXXXXXXXXXX	
RoHS Compliant	