

### Features

- 1.6mmX0.8mm SMT LED, 0.75mm THICKNESS.
- LOW POWER CONSUMPTION.
- WIDE VIEWING ANGLE.
- IDEAL FOR BACKLIGHT AND INDICATOR.
- VARIOUS COLORS AND LENS TYPES AVAILABLE.
- PACKAGE: 2000PCS / REEL .
- MOISTURE SENSITIVITY LEVEL : LEVEL 3.
- RoHS COMPLIANT.



Notes:

1. All dimensions are in millimeters (inches).
2. Tolerance is  $\pm 0.1(0.004)$  unless otherwise noted.
3. Specifications are subject to change without notice.

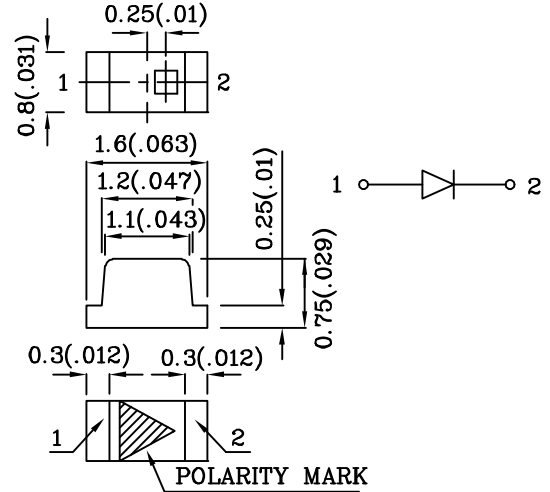

Absolute maximum ratings (TA=25°C)		MO (InGaAlP)	Unit
Reverse Voltage	V <sub>R</sub>	5	V
Forward Current	I <sub>F</sub>	30	mA
Forward Current (Peak) 1/10 Duty Cycle 0.1ms Pulse Width	i <sub>FS</sub>	195	mA
Power Dissipation	P <sub>T</sub>	75	mW
Operating Temperature	T <sub>A</sub>	-40 ~ +85	°C
Storage Temperature	T <sub>stg</sub>	-40 ~ +85	

Operating Characteristics (TA=25°C)		MO (InGaAlP)	Unit
Forward Voltage (Typ.) (I <sub>F</sub> =20mA)	V <sub>F</sub>	2.0	V
Forward Voltage (Max.) (I <sub>F</sub> =20mA)	V <sub>F</sub>	2.5	V
Reverse Current (Max.) (V <sub>R</sub> =5V)	I <sub>R</sub>	10	uA
Wavelength of Peak Emission (Typ.) (I <sub>F</sub> =20mA)	λ <sub>P</sub>	610	nm
Wavelength of Dominant Emission (Typ.) (I <sub>F</sub> =20mA)	λ <sub>D</sub>	601	nm
Spectral Line Full Width At Half-Maximum (Typ.) (I <sub>F</sub> =20mA)	Δλ	29	nm
Capacitance (Typ.) (V <sub>F</sub> =0V, f=1MHz)	C	30	pF

Part Number	Emitting Color	Emitting Material	Lens-color	Luminous Intensity (I <sub>F</sub> =20mA) mcd		Wavelength nm λ <sub>P</sub>	Viewing Angle 2θ 1/2
				min.	typ.		
ZMO53W-1	Orange	InGaAlP	Water Clear	70	198	610	120°
Published Date : FEB 23,2008      Drawing No :SDSA2405      V6      Checked : B.L.LIU      P.1/4							

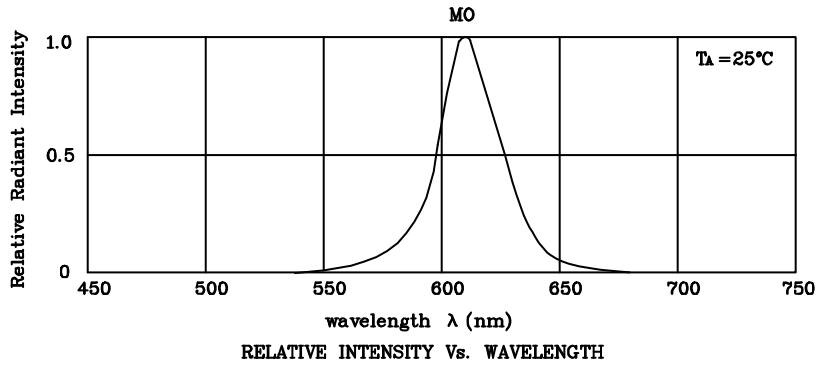

❖ MO

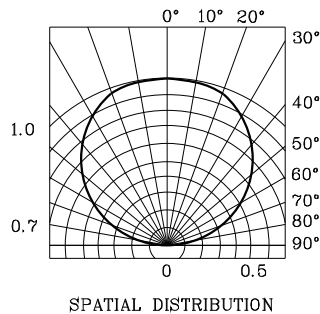
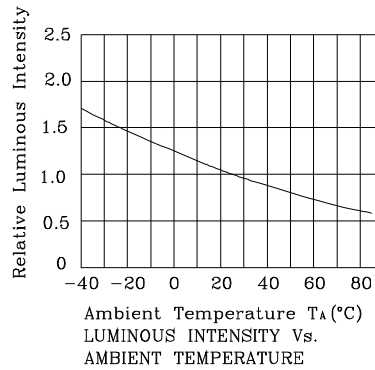
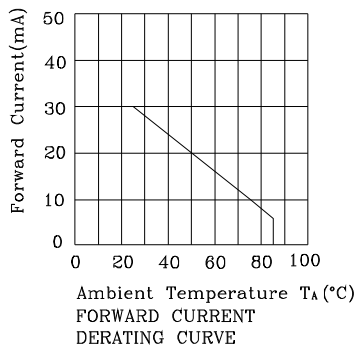
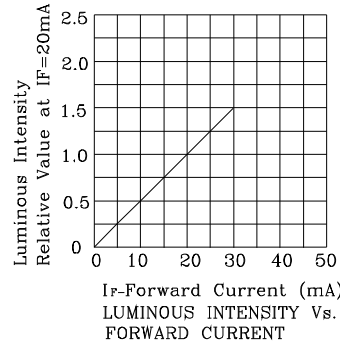
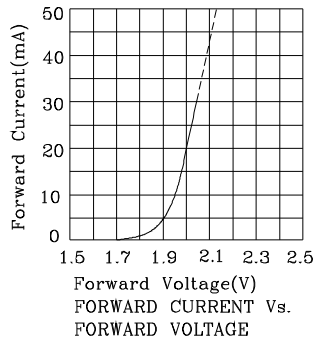

Reflow Soldering Profile For Lead-free SMT Process.

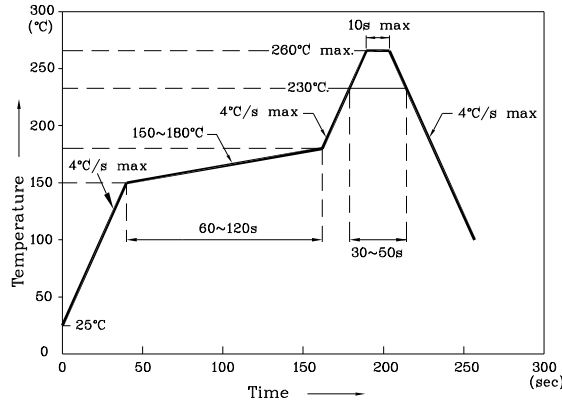

Notes:

1. Maximum soldering temperature should not exceed 260°C.
2. Recommended reflow temperature: 145°C-260°C.
3. Do not put stress to the epoxy resin during high temperatures conditions.

❖ Recommended Soldering Pattern  
 (Units : mm;Tolerance:± 0.1)

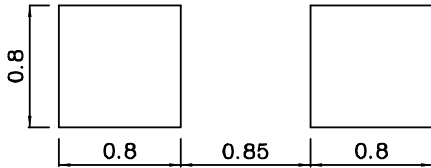

❖ The device has a single mounting surface. The device must be mounted according to the specifications.

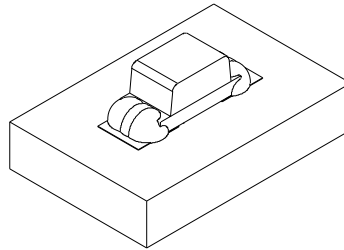

❖ Tape Specification (Units : mm)

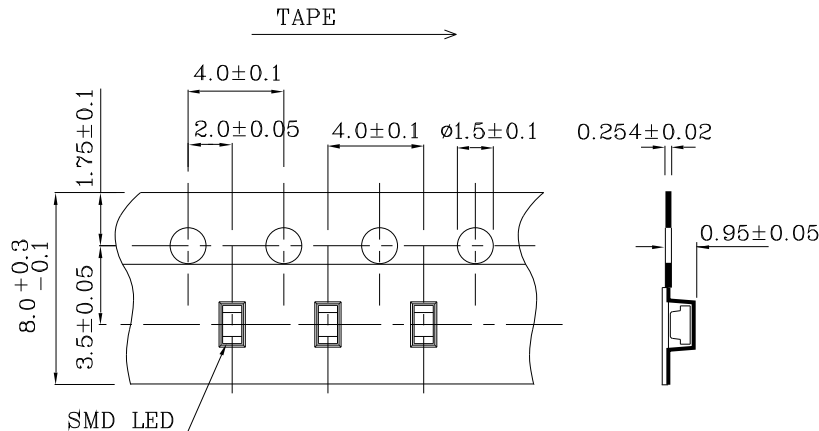

Remarks:

If special sorting is required (e.g. binning based on forward voltage, Luminous intensity / luminous flux, or wavelength), the typical accuracy of the sorting process is as follows:



1. Wavelength: +/-1nm
2. Luminous Intensity / Luminous Flux: +/-15%
3. Forward Voltage: +/-0.1V

Note: Accuracy may depend on the sorting parameters.

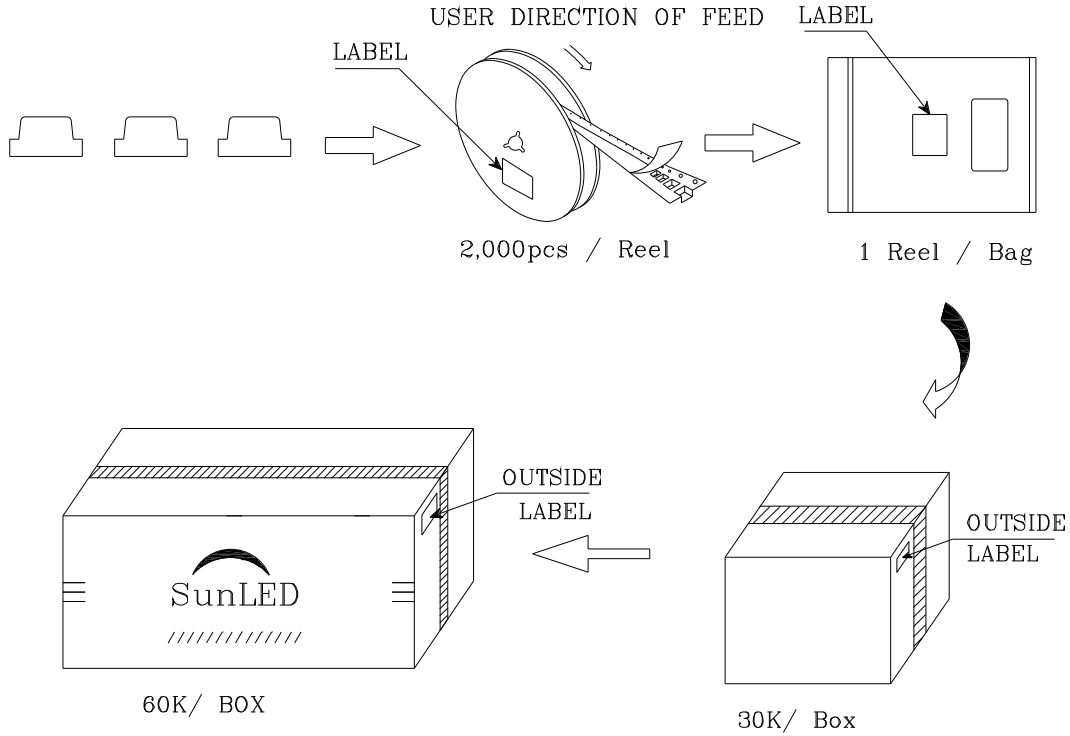

**PACKING & LABEL SPECIFICATIONS**

**ZMO53W-1**

Q.C.Q.C  
 XX XX XXXX  
 PASSED

P/NO : Zxxx53x-1	
QTY : 2000 pcs	CODE: XXX
S/N : XX	
LOT NO:	
 XXXXXXXXXXXXXXXXXXXXXXXX	
RoHS Compliant	