

SSM3K7002F

High-Speed Switching Applications
 Analog Switch Applications

Unit: mm

- Small package
- Low ON-resistance : $R_{on} = 3.3 \Omega$ (max) (@ $V_{GS} = 4.5 V$)
 : $R_{on} = 3.2 \Omega$ (max) (@ $V_{GS} = 5 V$)
 : $R_{on} = 3.0 \Omega$ (max) (@ $V_{GS} = 10 V$)

Maximum Ratings (Ta = 25°C)

Characteristics		Symbol	Rating	Unit
Drain-source voltage		V_{DS}	60	V
Gate-source voltage		V_{GSS}	± 20	V
Drain current	DC	I_D	200	mA
	Pulse	I_{DP}	800	
Drain power dissipation (Ta = 25°C)		P_D	200	mW
Channel temperature		T_{ch}	150	°C
Storage temperature range		T_{stg}	-55 to 150	°C

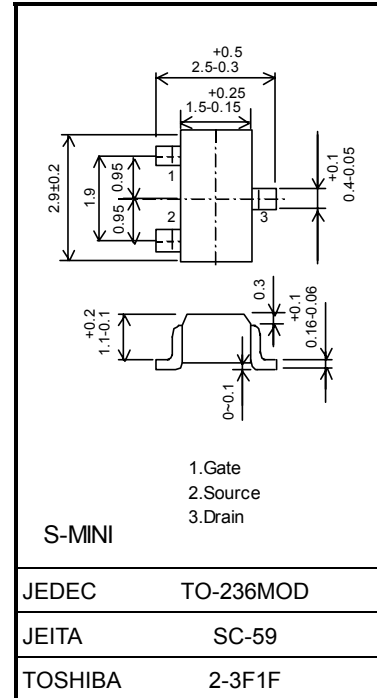

Weight: 0.012 g (typ.)

Electrical Characteristics (Ta = 25°C)

Characteristics		Symbol	Test Condition	Min	Typ	Max	Unit
Gate leakage current		I_{GSS}	$V_{GS} = \pm 20 V, V_{DS} = 0$	—	—	± 10	μA
Drain-source breakdown voltage		$V_{(BR) DSS}$	$I_D = 0.1 mA, V_{GS} = 0$	60	—	—	V
Drain cutoff current		I_{DSS}	$V_{DS} = 60 V, V_{GS} = 0$	—	—	1	μA
Gate threshold voltage		V_{th}	$V_{DS} = 10 V, I_D = 0.25 mA$	1.0	—	2.5	V
Forward transfer admittance		$ Y_{fs} $	$V_{DS} = 10 V, I_D = 200 mA$	170	—	—	mS
Drain-source ON-resistance		$R_{DS(ON)}$	$I_D = 500 mA, V_{GS} = 10 V$	—	2.0	3.0	Ω
			$I_D = 100 mA, V_{GS} = 5 V$	—	2.1	3.2	
			$I_D = 100 mA, V_{GS} = 4.5 V$	—	2.2	3.3	
Input capacitance		C_{iss}	$V_{DS} = 25 V, V_{GS} = 0, f = 1 MHz$	—	17	—	pF
Reverse transfer capacitance		C_{rss}		—	1.4	—	pF
Output capacitance		C_{oss}		—	5.8	—	pF
Switching time	Turn-on delay time	$t_{d(on)}$	$V_{DD} = 30 V, I_D = 200 mA, V_{GS} = 0 \text{ to } 10 V$	—	2.4	4.0	ns
	Turn-off delay time	$t_{d(off)}$		—	26	40	

Switching Time Test Circuit

(a) Test circuit

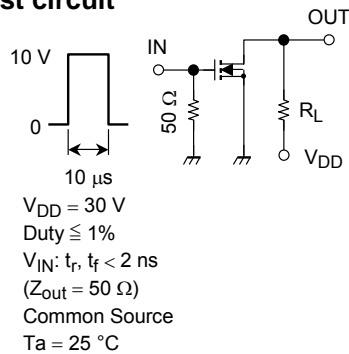

(b) V_{IN}

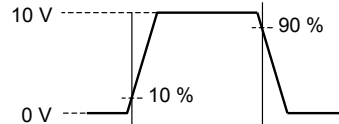

(c) V_{OUT}

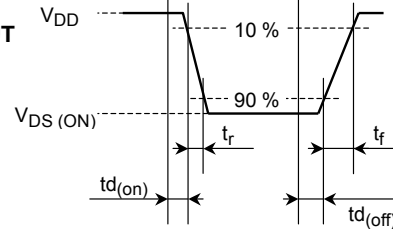

Marking

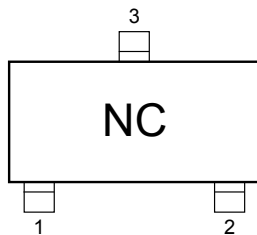

Equivalent Circuit (top view)

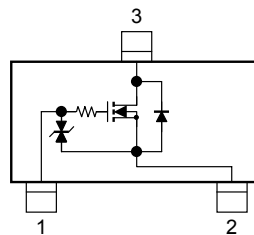

Precaution

V_{th} can be expressed as the voltage between gate and source when the low operating current value is $I_D = 0.25\text{ mA}$ for this product. For normal switching operation, $V_{GS(ON)}$ requires a higher voltage than V_{th} , and $V_{GS(OFF)}$ requires a lower voltage than V_{th} .

(The relationship can be established as follows: $V_{GS(OFF)} < V_{th} < V_{GS(ON)}$.)

Take this into consideration when using the device.

The recommended V_{GS} voltage for turning on this product is 4.5 V or higher.

Handling Precaution

When handling individual devices that are not yet mounted on a circuit board, make sure that the environment is protected against electrostatic discharge. Operators should wear antistatic clothing, and containers and other objects that come into direct contact with devices should be made of antistatic materials.

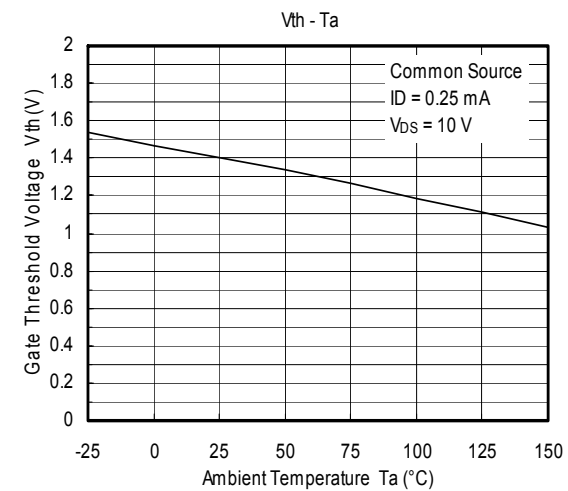
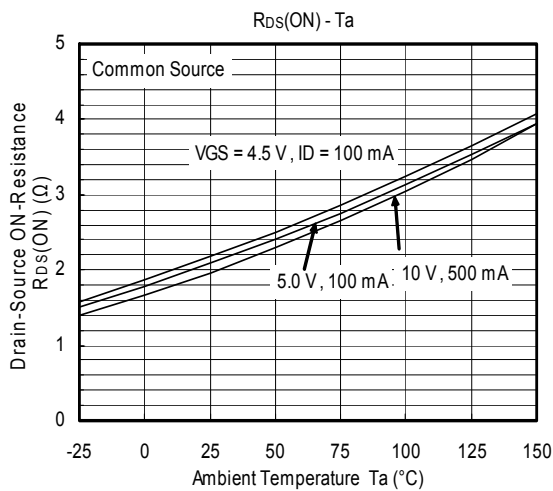
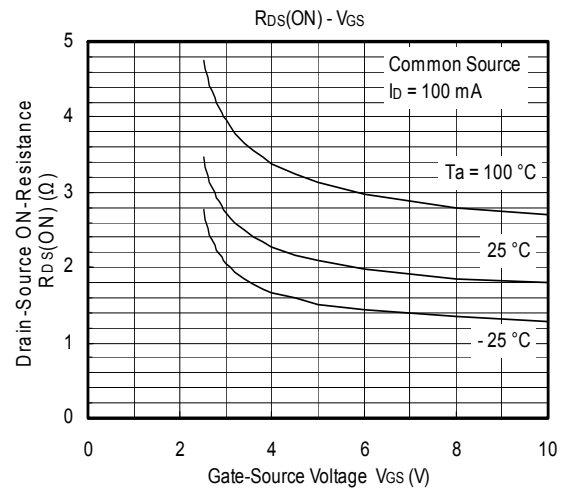
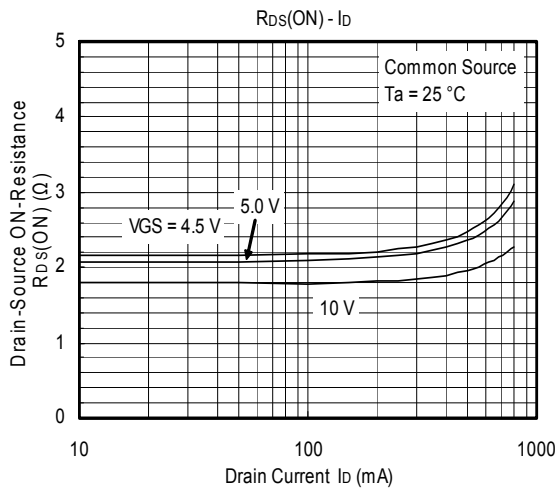
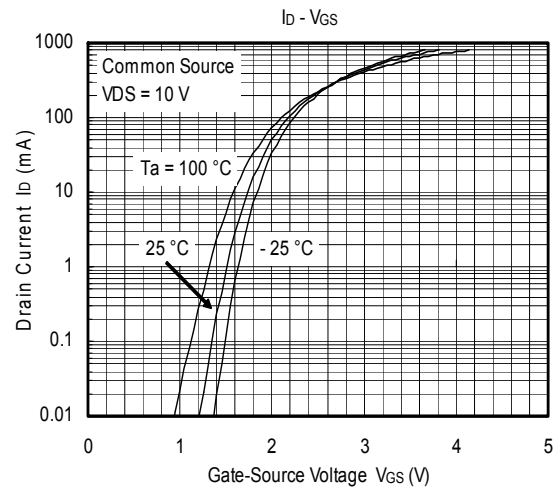
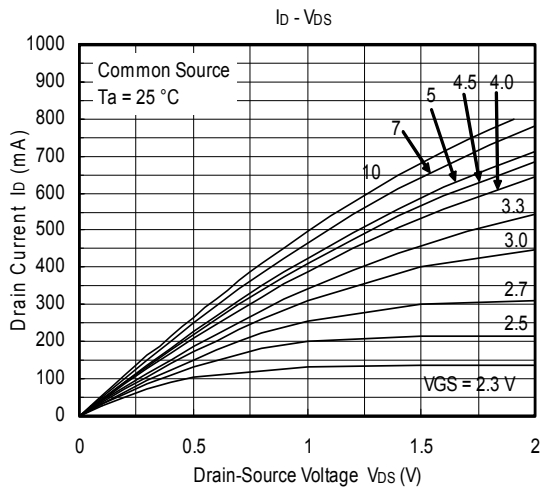

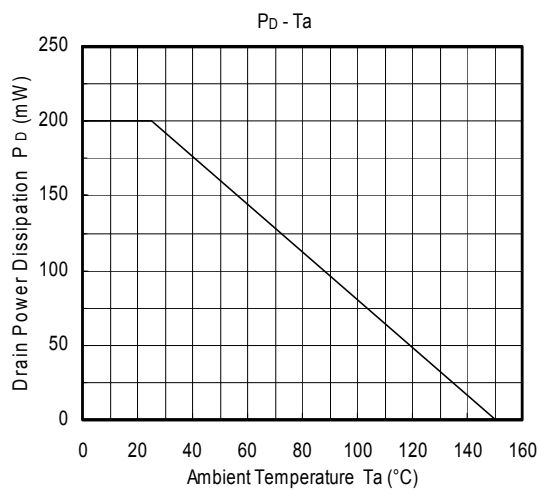
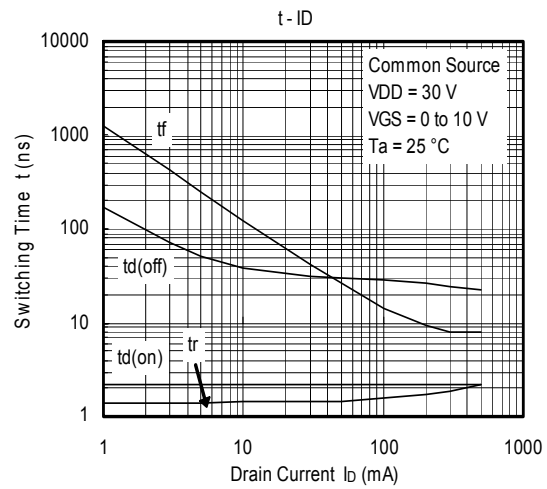
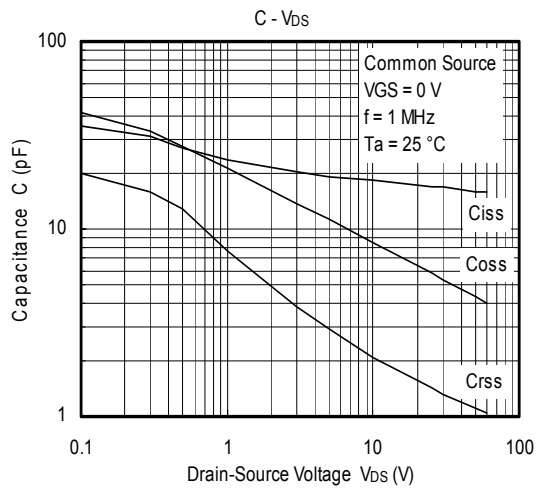
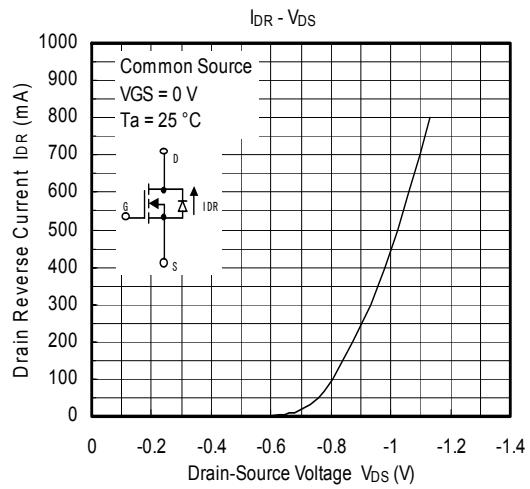
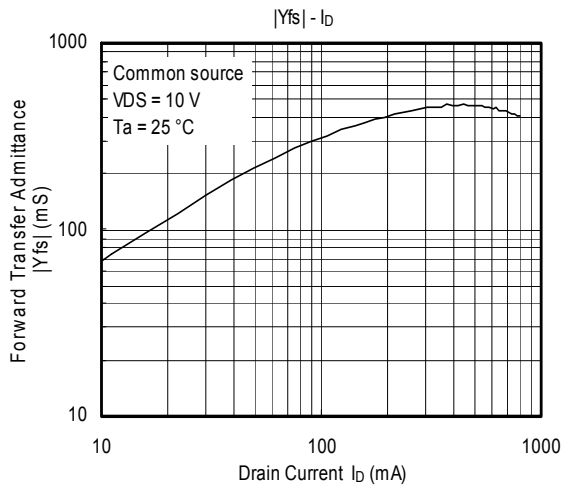

RESTRICTIONS ON PRODUCT USE

030619EAA

- The information contained herein is subject to change without notice.
- The information contained herein is presented only as a guide for the applications of our products. No responsibility is assumed by TOSHIBA for any infringements of patents or other rights of the third parties which may result from its use. No license is granted by implication or otherwise under any patent or patent rights of TOSHIBA or others.
- TOSHIBA is continually working to improve the quality and reliability of its products. Nevertheless, semiconductor devices in general can malfunction or fail due to their inherent electrical sensitivity and vulnerability to physical stress. It is the responsibility of the buyer, when utilizing TOSHIBA products, to comply with the standards of safety in making a safe design for the entire system, and to avoid situations in which a malfunction or failure of such TOSHIBA products could cause loss of human life, bodily injury or damage to property.
In developing your designs, please ensure that TOSHIBA products are used within specified operating ranges as set forth in the most recent TOSHIBA products specifications. Also, please keep in mind the precautions and conditions set forth in the "Handling Guide for Semiconductor Devices," or "TOSHIBA Semiconductor Reliability Handbook" etc..
- The TOSHIBA products listed in this document are intended for usage in general electronics applications (computer, personal equipment, office equipment, measuring equipment, industrial robotics, domestic appliances, etc.). These TOSHIBA products are neither intended nor warranted for usage in equipment that requires extraordinarily high quality and/or reliability or a malfunction or failure of which may cause loss of human life or bodily injury ("Unintended Usage"). Unintended Usage include atomic energy control instruments, airplane or spaceship instruments, transportation instruments, traffic signal instruments, combustion control instruments, medical instruments, all types of safety devices, etc.. Unintended Usage of TOSHIBA products listed in this document shall be made at the customer's own risk.
- TOSHIBA products should not be embedded to the downstream products which are prohibited to be produced and sold, under any law and regulations.