

Radiation Hardened Octal D-Type Flip-Flop, Three-State, Positive Edge Triggered

November 11, 2004

Features

- 3 Micron Radiation Hardened SOS CMOS
- Total Dose 200K RAD (Si)
- SEP Effective LET No Upsets: >100 MEV-cm²/mg
- Single Event Upset (SEU) Immunity < 2 x 10⁻⁹ Errors/Bit-Day (Typ)
- Dose Rate Survivability: >1 x 10¹² RAD (Si)/s
- Dose Rate Upset >10¹⁰ RAD (Si)/s 20ns Pulse
- Latch-Up Free Under Any Conditions
- Fanout (Over Temperature Range)
 - Bus Driver Outputs - 15 LSTTL Loads
- Military Temperature Range: -55°C to +125°C
- Significant Power Reduction Compared to LSTTL ICs
- DC Operating Voltage Range: 4.5V to 5.5V
- Input Logic Levels
 - VIL = 0.3 VCC Max
 - VIH = 0.7 VCC Min
- Input Current Levels $i_i \leq 5\mu\text{A}$ at VOL, VOH

Description

The Intersil HCS374MS is a Radiation Hardened non-inverting octal D-type, positive edge triggered flip-flop with three-stateable outputs. The HCS374MS utilizes advanced CMOS/SOS technology. The eight flip-flops enter data into their registers on the LOW-to-HIGH transition of the clock (CP). Data is also transferred to the outputs during this transition. The output enable ($\overline{\text{OE}}$) controls the three-state outputs and is independent of the register operation. When the output enable is high, the outputs are in the high impedance state.

The HCS374MS utilizes advanced CMOS/SOS technology to achieve high-speed operation. This device is a member of radiation hardened, high-speed, CMOS/SOS Logic Family.

The HCS374MS is supplied in a 20 lead Ceramic flatpack (K suffix) or a SBDIP Package (D suffix).

Pinouts

20 LEAD CERAMIC DUAL-IN-LINE METAL SEAL PACKAGE (SBDIP)
MIL-STD-1835 CDIP2-T20
TOP VIEW

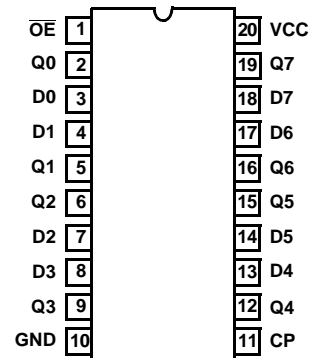

20 LEAD CERAMIC METAL SEAL FLATPACK PACKAGE (FLATPACK)
MIL-STD-1835 CDFP4-F20
TOP VIEW

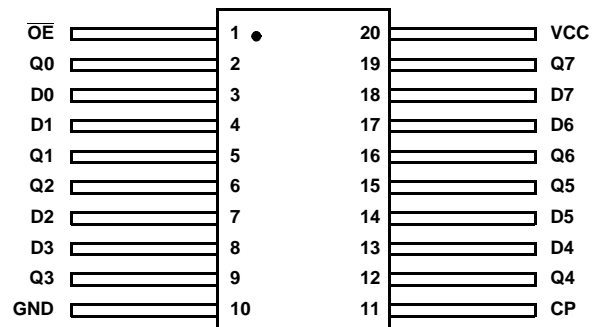



Ordering Information

PART NUMBER	TEMPERATURE RANGE	SCREENING LEVEL	PACKAGE
HCS374DMSR	-55°C to +125°C	Intersil Class S Equivalent	20 Lead SBDIP
HCS374KMSR	-55°C to +125°C	Intersil Class S Equivalent	20 Lead Ceramic Flatpack
HCS374D/Sample	+25°C	Sample	20 Lead SBDIP
HCS374K/Sample	+25°C	Sample	20 Lead Ceramic Flatpack
HCS374HMSR	+25°C	Die	Die

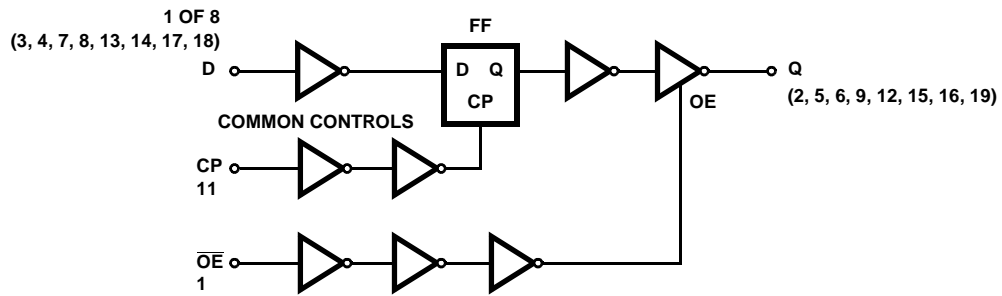
Functional Diagram



TRUTH TABLE

INPUTS			OUTPUTS
\overline{OE}	CP	Dn	Qn
L		H	H
L		L	L
L	L	X	Q0
H	X	X	Z

H =High Level (Steady State)

L =Low Level (Steady State)

X =Immaterial

Z =High Impedance

 = Transition from Low to High Level

Q0 =The level of Q before the indicated input conditions were established

Specifications HCS374MS

Absolute Maximum Ratings

Supply Voltage (VCC)	-0.5V to +7.0V
Input Voltage Range, All Inputs	-0.5V to VCC +0.5V
DC Input Current, Any One Input	±10mA
DC Drain Current, Any One Output	±25mA
(All Voltage Reference to the VSS Terminal)	
Storage Temperature Range (TSTG)	-65°C to +150°C
Lead Temperature (Soldering 10sec)	+265°C
Junction Temperature (TJ)	+175°C
ESD Classification	Class 1

Reliability Information

Thermal Resistance	θ_{JA}	θ_{JC}
SBDIP Package	72°C/W	24°C/W
Ceramic Flatpack Package	107°C/W	28°C/W
Maximum Package Power Dissipation at +125°C Ambient		
SBDIP Package	0.69W	
Ceramic Flatpack Package	0.47W	
If device power exceeds package dissipation capability, provide heat sinking or derate linearly at the following rate:		
SBDIP Package	13.9mW/°C	
Ceramic Flatpack Package	9.3mW/°C	

CAUTION: As with all semiconductors, stress listed under "Absolute Maximum Ratings" may be applied to devices (one at a time) without resulting in permanent damage. This is a stress rating only. Exposure to absolute maximum rating conditions for extended periods may affect device reliability. The conditions listed under "Electrical Performance Characteristics" are the only conditions recommended for satisfactory device operation.

Operating Conditions

Supply Voltage (VCC)	+4.5V to +5.5V	Input Low Voltage (VIL)	0.0V to 30% of VCC
Input Rise and Fall Times at 4.5V VCC (TR, TF)	500ns Max.	Input High Voltage (VIH)	70% of VCC to VCC
Operating Temperature Range (TA)	-55°C to +125°C		

TABLE 1. DC ELECTRICAL PERFORMANCE CHARACTERISTICS

PARAMETER	SYMBOL	(NOTE 1) CONDITIONS	GROUP A SUB- GROUPS	TEMPERATURE	LIMITS		UNITS
					MIN	MAX	
Quiescent Current	ICC	VCC = 5.5V, VIN = VCC or GND	1	+25°C	-	40	µA
			2, 3	+125°C, -55°C	-	750	µA
Output Current (Sink)	IOL	VCC = 4.5V, VIH = 4.5V, VOUT = 0.4V, VIL = 0V	1	+25°C	7.2	-	mA
			2, 3	+125°C, -55°C	6.0	-	mA
Output Current (Source)	IOH	VCC = 4.5V, VIH = 4.5V, VOUT = VCC -0.4V, VIL = 0V	1	+25°C	-7.2	-	mA
			2, 3	+125°C, -55°C	-6.0	-	mA
Output Voltage Low	VOL	VCC = 4.5V, VIH = 3.15V, IOL = 50µA, VIL = 1.35V	1, 2, 3	+25°C, +125°C, -55°C	-	0.1	V
		VCC = 5.5V, VIH = 3.85V, IOL = 50µA, VIL = 1.65V	1, 2, 3	+25°C, +125°C, -55°C	-	0.1	V
Output Voltage High	VOH	VCC = 4.5V, VIH = 3.15V, IOH = -50µA, VIL = 1.35V	1, 2, 3	+25°C, +125°C, -55°C	VCC -0.1	-	V
		VCC = 5.5V, VIH = 3.85V, IOH = -50µA, VIL = 1.65V	1, 2, 3	+25°C, +125°C, -55°C	VCC -0.1	-	V
Input Leakage Current	IIN	VCC = 5.5V, VIN = VCC or GND	1	+25°C	-	±0.5	µA
			2, 3	+125°C, -55°C	-	±5.0	µA
Three-State Output Leakage Current	IOZ	Applied Voltage = 0V or VCC, VCC = 5.5V	1	+25°C	-	±1	µA
			2, 3	+125°C, -55°C	-	±50	µA
Noise Immunity Functional Test	FN	VCC = 4.5V, VIH = 0.70(VCC), VIL = 0.30(VCC), (Note 2)	7, 8A, 8B	+25°C, +125°C, -55°C	-	-	-

NOTES:

1. All voltages reference to device GND.
2. For functional tests $VO \geq 4.0V$ is recognized as a logic "1", and $VO \leq 0.5V$ is recognized as a logic "0".

Specifications HCS374MS

TABLE 2. AC ELECTRICAL PERFORMANCE CHARACTERISTICS

PARAMETER	SYMBOL	(NOTES 1, 2) CONDITIONS	GROUP A SUB- GROUPS	TEMPERATURE	LIMITS		UNITS
					MIN	MAX	
Clock to Q	TPLH, TPHL	VCC = 4.5V	9	+25°C	2	22	ns
			10, 11	+125°C, -55°C	2	26	ns
Enable to Output	TPZL, TPZH	VCC = 4.5V	9	+25°C	2	20	ns
			10, 11	+125°C, -55°C	2	23	ns
Disable to Output	TPLZ	VCC = 4.5V	9	+25°C	2	20	ns
			10, 11	+125°C, -55°C	2	23	ns
	TPHZ	VCC = 4.5V	9	+25°C	2	18	ns
			10, 11	+125°C, -55°C	2	20	ns

NOTES:

1. All voltages referenced to device GND.
2. AC measurements assume RL = 500Ω, CL = 50pF, Input TR = TF = 3ns, VIL = GND, VIH = VCC.

TABLE 3. ELECTRICAL PERFORMANCE CHARACTERISTICS

PARAMETER	SYMBOL	(NOTE 1) CONDITIONS	TEMPERATURE	LIMITS		UNITS
				MIN	MAX	
Capacitance Power Dissipation	CPD	VCC = 5.0V, f = 1MHz	+25°C	-	11	pF
			+125°C, -55°C	-	35	pF
Input Capacitance	CIN	VCC = 5.0V, f = 1MHz	+25°C	-	10	pF
			+125°C	-	10	pF
Output Transition Time	TTHL TTLH	VCC = 4.5V	+25°C	-	12	ns
			+125°C, -55°C	-	18	ns
Max Operating Frequency	FMAX	VCC = 4.5V	+25°C	-	30	MHz
			+125°C, -55°C	-	20	MHz
Setup Time Data to Clock	TSU	VCC = 4.5V	+25°C	12	-	ns
			+125°C, -55°C	18	-	ns
Hold Time Data to Clock	TH	VCC = 4.5V	+25°C	5	-	ns
			+125°C, -55°C	5	-	ns
Pulse Width Clock	TW	VCC = 4.5V	+25°C	16	-	ns
			+125°C, -55°C	24	-	ns

NOTE:

1. The parameters listed in Table 3 are controlled via design or process parameters. Min and Max Limits are guaranteed but not directly tested. These parameters are characterized upon initial design release and upon design changes which affect these characteristics.

Specifications HCS374MS

TABLE 4. DC POST RADIATION ELECTRICAL PERFORMANCE CHARACTERISTICS

PARAMETER	SYMBOL	(NOTES 1, 2) CONDITIONS	TEMPERATURE	200K RAD LIMITS		UNITS
				MIN	MAX	
Quiescent Current	ICC	VCC = 5.5V, VIN = VCC or GND	+25°C	-	0.75	mA
Output Current (Sink)	IOL	VCC = 4.5V, VIN = VCC or GND, VOUT = 0.4V	+25°C	6.0	-	mA
Output Current (Source)	IOH	VCC = 4.5V, VIN = VCC or GND, VOUT = VCC -0.4V	+25°C	-6.0	-	mA
Output Voltage Low	VOL	VCC = 4.5V and 5.5V, VIH = 0.70(VCC), VIL = 0.30(VCC), IOL = 50μA	+25°C	-	0.1	V
Output Voltage High	VOH	VCC = 4.5V and 5.5V, VIH = 0.70(VCC), VIL = 0.30(VCC), IOH = -50μA	+25°C	VCC -0.1	-	V
Input Leakage Current	IIN	VCC = 5.5V, VIN = VCC or GND	+25°C	-	±5	μA
Three-State Output Leakage Current	IOZ	Applied Voltage = 0V or VCC, VCC = 5.5V	+25°C	-	±50	μA
Noise Immunity Functional Test	FN	VCC = 4.5V, VIH = 0.70(VCC), VIL = 0.30(VCC), (Note 3)	+25°C	-	-	-
Clock to Q	TPLH, TPHL	VCC = 4.5V	+25°C	2	26	ns
Enable to Output	TPZL, TPZH	VCC = 4.5V	+25°C	2	23	
Disable to Output	TPLZ	VCC = 4.5V	+25°C	2	23	ns
	TPHZ	VCC = 4.5V	+25°C	2	20	ns

NOTES:

1. All voltages referenced to device GND.
2. AC measurements assume RL = 500Ω, CL = 50pF, Input TR = TF = 3ns, VIL = GND, VIH = VCC
3. For functional tests VO ≥ 4.0V is recognized as a logic "1", and VO ≤ 0.5V is recognized as a logic "0".

TABLE 5. BURN-IN AND OPERATING LIFE TEST, DELTA PARAMETERS (+25°C)

PARAMETER	GROUP B SUBGROUP	DELTA LIMIT
ICC	5	12μA
IOL/IOH	5	-15% of 0 Hour
IOZL/IOZH	5	±200nA

Specifications HCS374MS

TABLE 6. APPLICABLE SUBGROUPS

CONFORMANCE GROUPS		METHOD	GROUP A SUBGROUPS	READ AND RECORD
Initial Test (Preburn-In)		100%/5004	1, 7, 9	ICC, IOL/H, IOZL/H
Interim Test I (Postburn-In)		100%/5004	1, 7, 9	ICC, IOL/H, IOZL/H
Interim Test II (Postburn-In)		100%/5004	1, 7, 9	ICC, IOL/H, IOZL/H
PDA		100%/5004	1, 7, 9, Deltas	
Interim Test III (Postburn-In)		100%/5004	1, 7, 9	ICC, IOL/H, IOZL/H
PDA		100%/5004	1, 7, 9, Deltas	
Final Test		100%/5004	2, 3, 8A, 8B, 10, 11	
Group A (Note 1)		Sample/5005	1, 2, 3, 7, 8A, 8B, 9, 10, 11	
Group B	Subgroup B-5	Sample/5005	1, 2, 3, 7, 8A, 8B, 9, 10, 11, Deltas	Subgroups 1, 2, 3, 9, 10, 11, (Notes)
	Subgroup B-6	Sample/5005	1, 7, 9	
Group D		Sample/5005	1, 7, 9	

NOTES:

1. Alternate Group A testing in accordance with Method 5005 of MIL-STD-883 may be exercised.
2. Table 5 parameters only.

TABLE 7. TOTAL DOSE IRRADIATION

CONFORMANCE GROUPS	METHOD	TEST		READ AND RECORD	
		PRE RAD	POST RAD	PRE RAD	POST RAD
Group E Subgroup 2	5005	1, 7, 9	Table 4	1, 9	Table 4 (Note 1)

NOTE:

1. Except FN test which will be performed 100% Go/No-Go.

TABLE 8. STATIC BURN-IN AND DYNAMIC BURN-IN TEST CONNECTIONS

OPEN	GROUND	1/2 VCC = 3V ± 0.5V	VCC = 6V ± 0.5V	OSCILLATOR	
				50kHz	25kHz
STATIC BURN-IN I TEST CONNECTIONS (Note 1)					
2, 5, 6, 9, 12, 15, 16, 19	1, 3, 4, 7, 8, 10, 11, 13, 14, 17, 18	-	20	-	-
STATIC BURN-IN II TEST CONNECTIONS (Note 1)					
2, 5, 6, 9, 12, 15, 16, 19	10	-	1, 3, 4, 7, 8, 11, 13, 14, 17, 18, 20	-	-
DYNAMIC BURN-IN TEST CONNECTIONS (Note 2)					
-	1, 10	2, 5, 6, 9, 12, 15, 16, 19	20	11	3, 4, 7, 8, 13, 14, 17, 18

NOTES:

1. Each pin except VCC and GND will have a resistor of 1KΩ ± 5% for dynamic burn-in.
2. Each pin except VCC and GND will have a resistor of 680Ω ± 5% for dynamic burn-in.

TABLE 9. IRRADIATION TEST CONNECTIONS

OPEN	GROUND	VCC = 5V ± 0.5V
2, 5, 6, 9, 12, 15, 16, 19	10	1, 3, 4, 7, 8, 11, 13, 14, 17, 18, 20

NOTE: Each pin except VCC and GND will have a resistor of 47KΩ ± 5% for irradiation testing.
Group E, Subgroup 2, sample size is 4 dice/wafer 0 failures.

Intersil Space Level Product Flow - 'MS'

Wafer Lot Acceptance (All Lots) Method 5007 (Includes SEM)	100% Interim Electrical Test 1 (T1)
GAMMA Radiation Verification (Each Wafer) Method 1019, 4 Samples/Wafer, 0 Rejects	100% Delta Calculation (T0-T1)
100% Nondestructive Bond Pull, Method 2023	100% Static Burn-In 2, Condition A or B, 24 hrs. min., +125°C min., Method 1015
Sample - Wire Bond Pull Monitor, Method 2011	100% Interim Electrical Test 2 (T2)
Sample - Die Shear Monitor, Method 2019 or 2027	100% Delta Calculation (T0-T2)
100% Internal Visual Inspection, Method 2010, Condition A	100% PDA 1, Method 5004 (Notes 1 and 2)
100% Temperature Cycle, Method 1010, Condition C, 10 Cycles	100% Dynamic Burn-In, Condition D, 240 hrs., +125°C or Equivalent, Method 1015
100% Constant Acceleration, Method 2001, Condition per Method 5004	100% Interim Electrical Test 3 (T3)
100% PIND, Method 2020, Condition A	100% Delta Calculation (T0-T3)
100% External Visual	100% PDA 2, Method 5004 (Note 2)
100% Serialization	100% Final Electrical Test
100% Initial Electrical Test (T0)	100% Fine/Gross Leak, Method 1014
100% Static Burn-In 1, Condition A or B, 24 hrs. min., +125°C min., Method 1015	100% Radiographic, Method 2012 (Note 3)
	100% External Visual, Method 2009
	Sample - Group A, Method 5005 (Note 4)
	100% Data Package Generation (Note 5)

NOTES:

1. Failures from Interim electrical test 1 and 2 are combined for determining PDA 1.
2. Failures from subgroup 1, 7, 9 and deltas are used for calculating PDA. The maximum allowable PDA = 5% with no more than 3% of the failures from subgroup 7.
3. Radiographic (X-Ray) inspection may be performed at any point after serialization as allowed by Method 5004.
4. Alternate Group A testing may be performed as allowed by MIL-STD-883, Method 5005.
5. Data Package Contents:
 - Cover Sheet (Intersil Name and/or Logo, P.O. Number, Customer Part Number, Lot Date Code, Intersil Part Number, Lot Number, Quantity).
 - Wafer Lot Acceptance Report (Method 5007). Includes reproductions of SEM photos with percent of step coverage.
 - GAMMA Radiation Report. Contains Cover page, disposition, Rad Dose, Lot Number, Test Package used, Specification Numbers, Test equipment, etc. Radiation Read and Record data on file at Intersil.
 - X-Ray report and film. Includes penetrometer measurements.
 - Screening, Electrical, and Group A attributes (Screening attributes begin after package seal).
 - Lot Serial Number Sheet (Good units serial number and lot number).
 - Variables Data (All Delta operations). Data is identified by serial number. Data header includes lot number and date of test.
 - The Certificate of Conformance is a part of the shipping invoice and is not part of the Data Book. The Certificate of Conformance is signed by an authorized Quality Representative.

AC Timing Diagrams

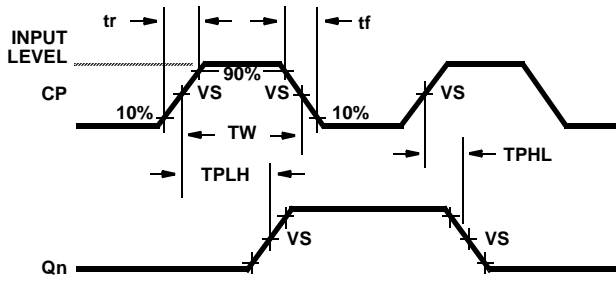

FIGURE 1. CLOCK TO OUTPUT DELAYS AND CLOCK PULSE WIDTH

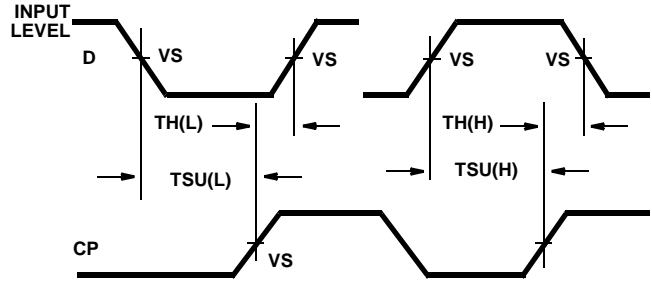

FIGURE 2. DATA SET-UP AND HOLD TIMES

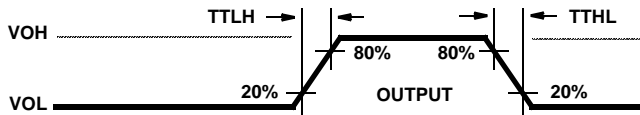
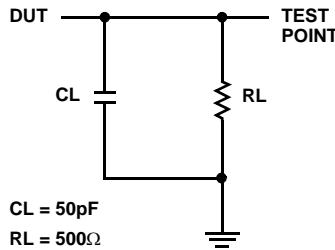

FIGURE 3. OUTPUT TRANSITION TIME

AC VOLTAGE LEVELS

PARAMETER	HCS	UNITS
VCC	4.50	V
VIH	4.50	V
VS	2.25	V
VIL	0	V
GND	0	V

AC Load Circuit



All Intersil semiconductor products are manufactured, assembled and tested under **ISO9000** quality systems certification.

Intersil products are sold by description only. Intersil Corporation reserves the right to make changes in circuit design and/or specifications at any time without notice. Accordingly, the reader is cautioned to verify that data sheets are current before placing orders. Information furnished by Intersil is believed to be accurate and reliable. However, no responsibility is assumed by Intersil or its subsidiaries for its use; nor for any infringements of patents or other rights of third parties which may result from its use. No license is granted by implication or otherwise under any patent or patent rights of Intersil or its subsidiaries.

For information regarding Intersil Corporation and its products, see web site <http://www.intersil.com>

Three-State Low Timing Diagrams

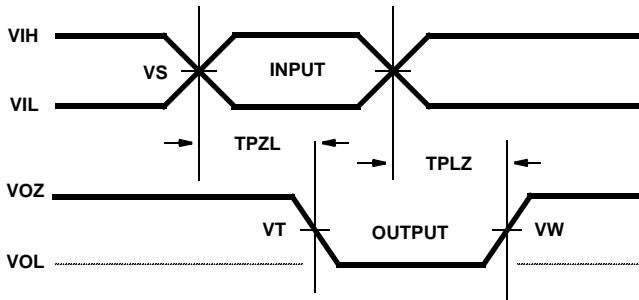

THREE-STATE LOW VOLTAGE LEVELS

PARAMETER	HCS	UNITS
VCC	4.50	V
VIH	4.50	V
VS	2.25	V
VT	2.25	V
VW	0.90	V
GND	0	V
VIL	0	V

Three-State Low Load Circuit

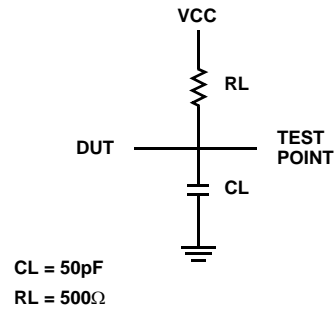

Three-State High Timing Diagrams

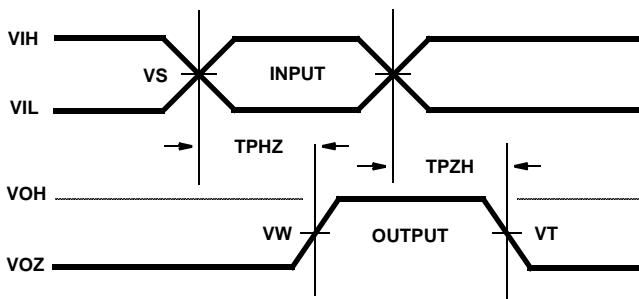

THREE-STATE HIGH VOLTAGE LEVELS

PARAMETER	HCS	UNITS
VCC	4.50	V
VIH	4.50	V
VS	2.25	V
VT	2.25	V
VW	3.60	V
GND	0	V

THREE-STATE HIGH VOLTAGE LEVELS

PARAMETER	HCS	UNITS
VIL	0	V

Three-State High Load Circuit

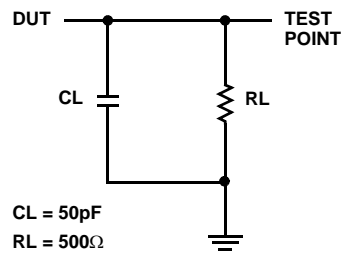

HCS374MS

Die Characteristics

DIE DIMENSIONS:

108 x 106 mils

METALLIZATION:

Type: AlSi

Metal Thickness: $11\text{k}\text{\AA} \pm 1\text{k}\text{\AA}$

GLASSIVATION:

Type: SiO_2

Thickness: $13\text{k}\text{\AA} \pm 2.6\text{k}\text{\AA}$

WORST CASE CURRENT DENSITY:

$< 2.0 \times 10^5 \text{A/cm}^2$

BOND PAD SIZE:

$100\mu\text{m} \times 100\mu\text{m}$

4 mils x 4 mils

Metallization Mask Layout

HCS374MS

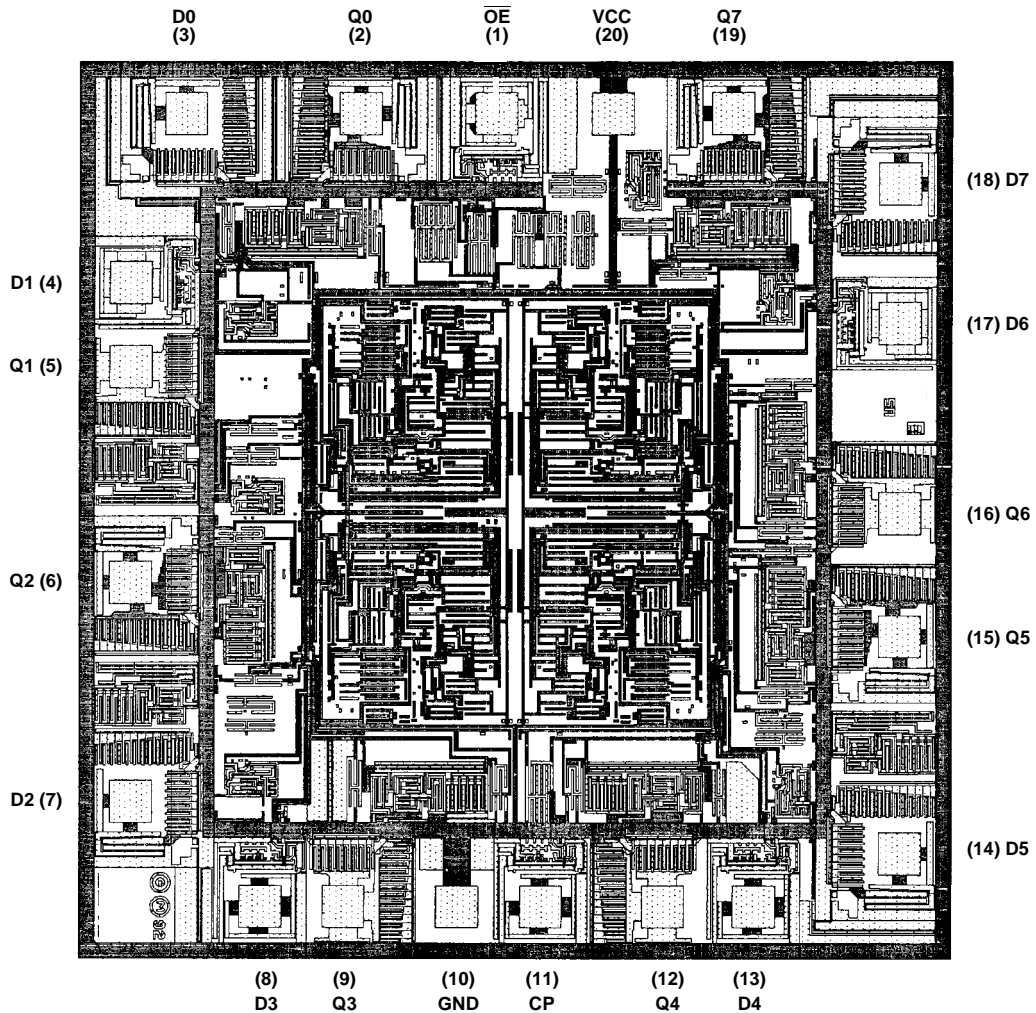

NOTE: The die diagram is a generic plot from a similar HCS device. It is intended to indicate approximate die size and bond pad location. The mask series for the HCS374 is TA14304B.