

ZXMN6A11Z

60V SOT89 N-channel enhancement mode MOSFET

Summary

$V_{(BR)DSS}$	$R_{DS(on)}$ (Ω)	I_D (A)
60	0.120 @ $V_{GS} = 10V$	3.6
	0.180 @ $V_{GS} = 4.5V$	2.9

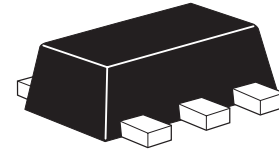

Description

This new generation trench MOSFET from Zetex features a unique structure combining the benefits of low on-resistance and fast switching, making it ideal for high efficiency power management applications.

Features

- Low on-resistance
- Fast switching speed
- Low threshold
- Low gate drive
- SOT89 package

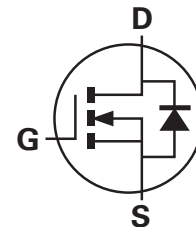

Applications

- DC-DC converters
- Power management functions
- Disconnect switches
- Motor control

Ordering information

Device	Reel size (inches)	Tape width (mm)	Quantity per reel
ZXMN6A11ZTA	7	12	1,000

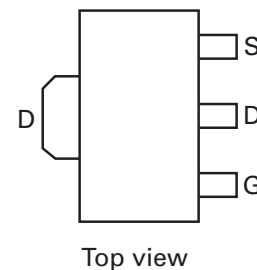

Device marking

11N6

ZXMN6A11Z

Absolute maximum ratings

Parameter	Symbol	Limit	Unit
Drain-source voltage	V_{DSS}	60	V
Gate-source voltage	V_{GS}	± 20	V
Continuous drain current @ $V_{GS} = 10V$; $T_{amb} = 25^{\circ}C^{(b)}$ @ $V_{GS} = 10V$; $T_{amb} = 70^{\circ}C^{(b)}$ @ $V_{GS} = 10V$; $T_{amb} = 25^{\circ}C^{(a)}$	I_D	3.6	A
		2.9	
		2.7	
Pulsed drain current ^(c)	I_{DM}	14.5	A
Continuous source current (body diode) ^(b)	I_S	3.7	A
Pulsed source current (body diode) ^(c)	I_{SM}	14.5	A
Power dissipation at $T_{amb} = 25^{\circ}C^{(a)}$	P_D	1.5	W
Linear derating factor		12	mW/ $^{\circ}C$
Power dissipation at $T_{amb} = 25^{\circ}C^{(b)}$	P_D	2.6	W
Linear derating factor		21	mW/ $^{\circ}C$
Operating and storage temperature range	T_j, T_{stg}	-55 to +150	$^{\circ}C$

Thermal resistance

Parameter	Symbol	Limit	Unit
Junction to ambient ^(a)	$R_{\theta JA}$	83.3	$^{\circ}C/W$
Junction to ambient ^(b)	$R_{\theta JA}$	47.4	$^{\circ}C/W$

NOTES:

(a) For a device surface mounted on 25mm x 25mm FR4 PCB with high coverage of single sided 1oz copper, in still air conditions.

(b) For a device surface mounted on FR4 PCB measured at $t = 10$ sec.

(c) Repetitive rating - 25mm x 25mm FR4 PCB, $D=0.02$, pulse width 300 μs - pulse width limited by maximum junction temperature.

ZXMN6A11Z

Typical characteristics

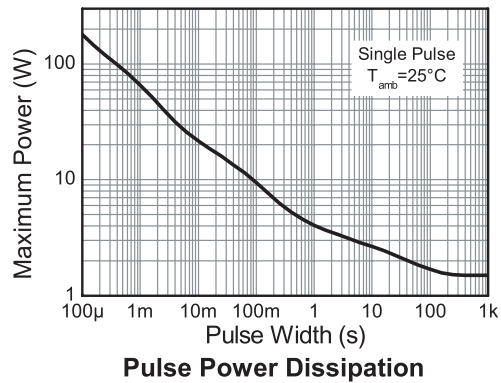
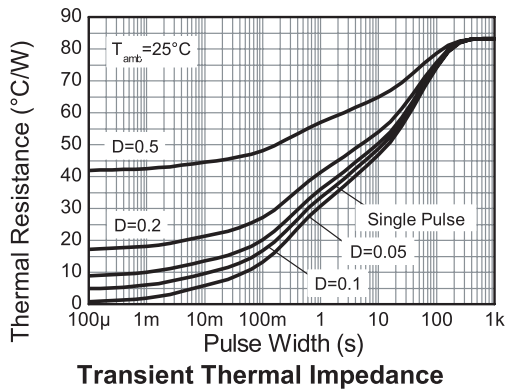
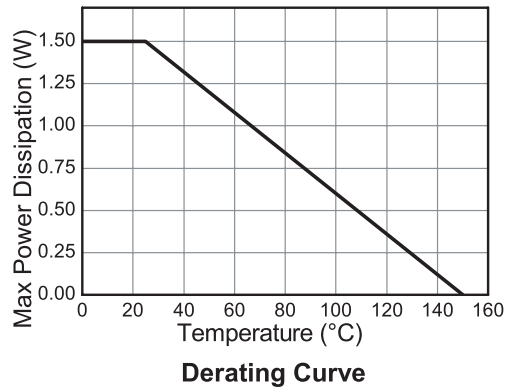
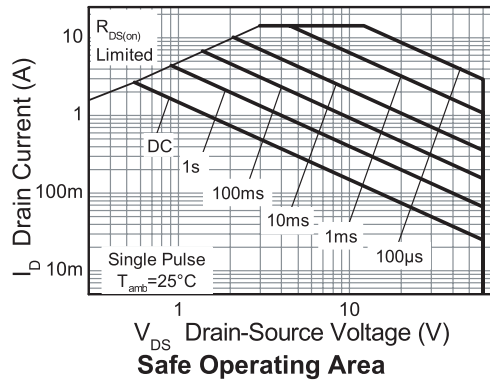

ZXMN6A11Z

Electrical characteristics (@ $T_{amb} = 25^{\circ}\text{C}$ unless otherwise stated)

Parameter	Symbol	Min.	Typ.	Max.	Unit	Conditions
Static						
Drain-source breakdown voltage	$V_{(BR)DSS}$	60			V	$I_D = 250\mu\text{A}$, $V_{GS} = 0\text{V}$
Zero gate voltage drain current	I_{DSS}			1.0	μA	$V_{DS} = 60\text{V}$, $V_{GS} = 0\text{V}$
Gate-body leakage	I_{GSS}			100	nA	$V_{GS} = \pm 20\text{V}$, $V_{DS} = 0\text{V}$
Gate-source threshold voltage	$V_{GS(th)}$	1.0			V	$I_D = 250\mu\text{A}$, $V_{DS} = V_{GS}$
Static drain-source on-state resistance (*)	$R_{DS(on)}$			0.120	Ω	$V_{GS} = 10\text{V}$, $I_D = 2.5\text{A}$
				0.180	Ω	$V_{GS} = 4.5\text{V}$, $I_D = 2\text{A}$
Forward transconductance(*) (‡)	g_{fs}		4.9		S	$V_{DS} = 15\text{V}$, $I_D = 2.5\text{A}$
Dynamic (‡)						
Input capacitance	C_{iss}		330		pF	$V_{DS} = 40\text{V}$, $V_{GS} = 0\text{V}$ $f = 1\text{MHz}$
Output capacitance	C_{oss}		35.2		pF	
Reverse transfer capacitance	C_{rss}		17.1		pF	
Switching (†) (‡)						
Turn-on-delay time	$t_{d(on)}$		1.95		ns	$V_{DD} = 30\text{V}$, $I_D = 2.5\text{A}$ $R_G = 6.0\Omega$, $V_{GS} = 10\text{V}$
Rise time	t_r		3.5		ns	
Turn-off delay time	$t_{d(off)}$		8.2		ns	
Fall time	t_f		4.6		ns	
Gate charge	Q_g		3.0		nC	$V_{DS} = 15\text{V}$, $V_{GS} = 5\text{V}$ $I_D = 2.5\text{A}$
Total gate charge	Q_g		5.7		nC	$V_{DS} = 15\text{V}$, $V_{GS} = 10\text{V}$ $I_D = 2.5\text{A}$
Gate-source charge	Q_{gs}		1.25		nC	
Gate drain charge	Q_{gd}		0.86		nC	
Source-drain diode						
Diode forward voltage(*)	V_{SD}		0.85	0.95	V	$T_j = 25^{\circ}\text{C}$, $I_S = 2.8\text{A}$, $V_{GS} = 0\text{V}$
Reverse recovery time (‡)	t_{rr}		21.5		ns	$T_j = 25^{\circ}\text{C}$, $I_S = 2.5\text{A}$, $di/dt = 100\text{A}/\mu\text{s}$
Reverse recovery charge (‡)	Q_{rr}		20.5		nC	

NOTES:

(*) Measured under pulsed conditions. Pulse width $\leq 300\mu\text{s}$; duty cycle $\leq 2\%$.

(†) Switching characteristics are independent of operating junction temperature.

(‡) For design aid only, not subject to production testing.

Typical characteristics

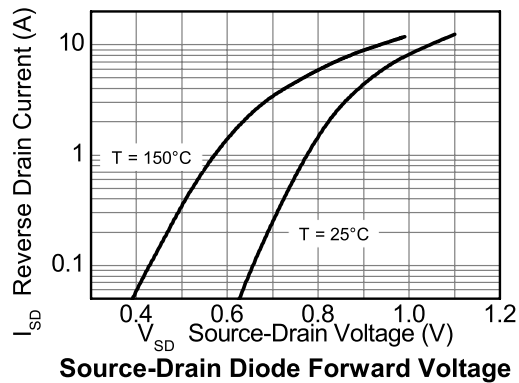
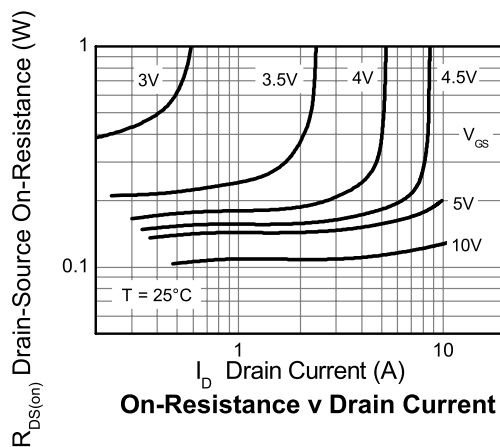
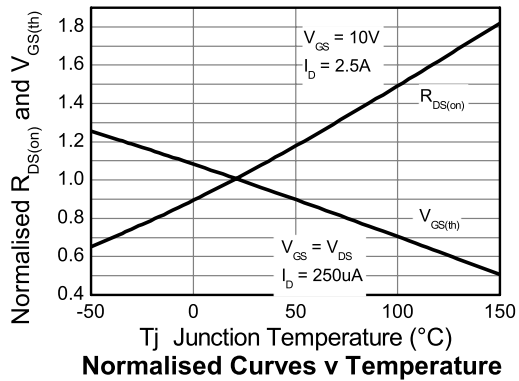
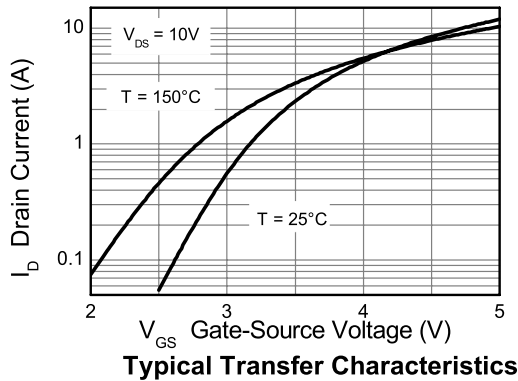
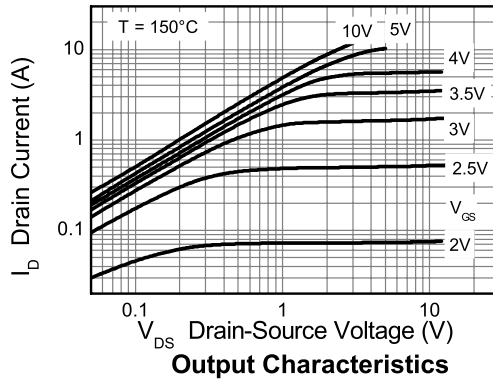
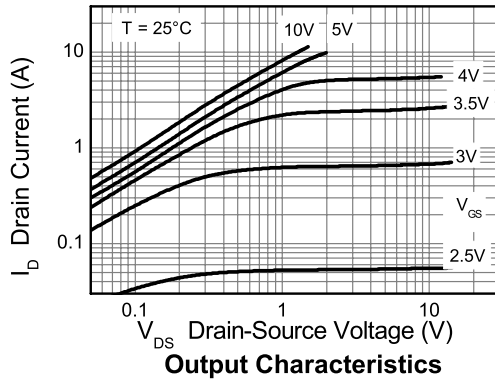

ZXMN6A11Z

Typical characteristics

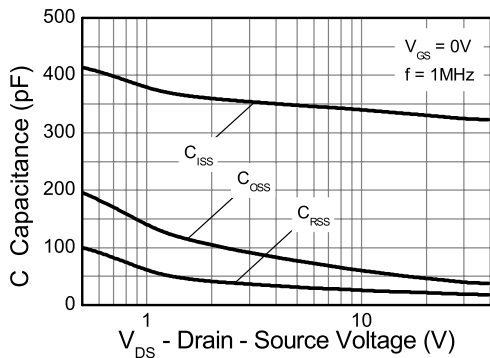

Capacitance v Drain-Source Voltage

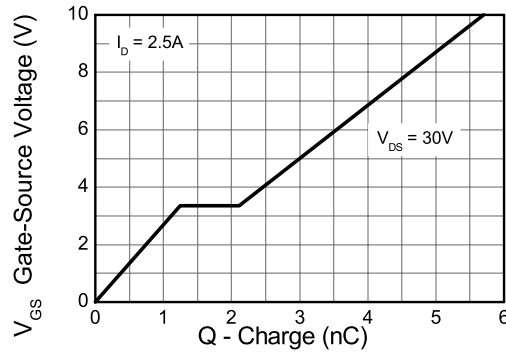

Gate-Source Voltage v Gate Charge

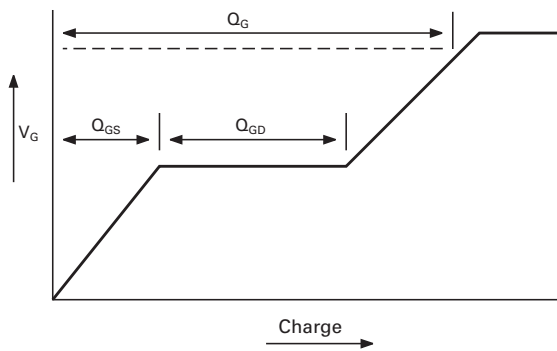

Basic gate charge waveform

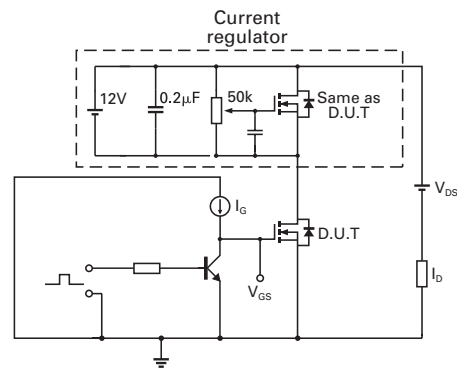

Gate charge test circuit

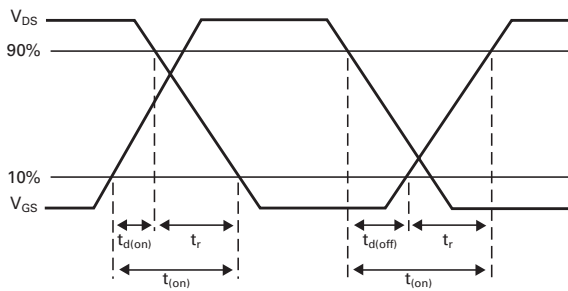

Switching time waveforms

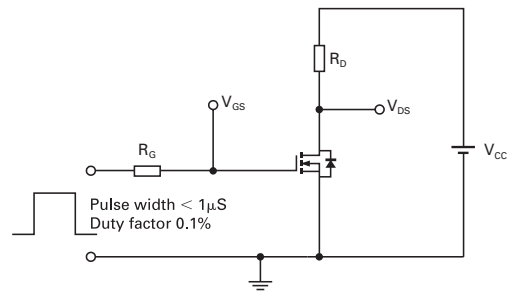

Switching time test circuit

ZXMN6A11Z

Intentionally left blank

ZXMN6A11Z

Package outline - SOT89

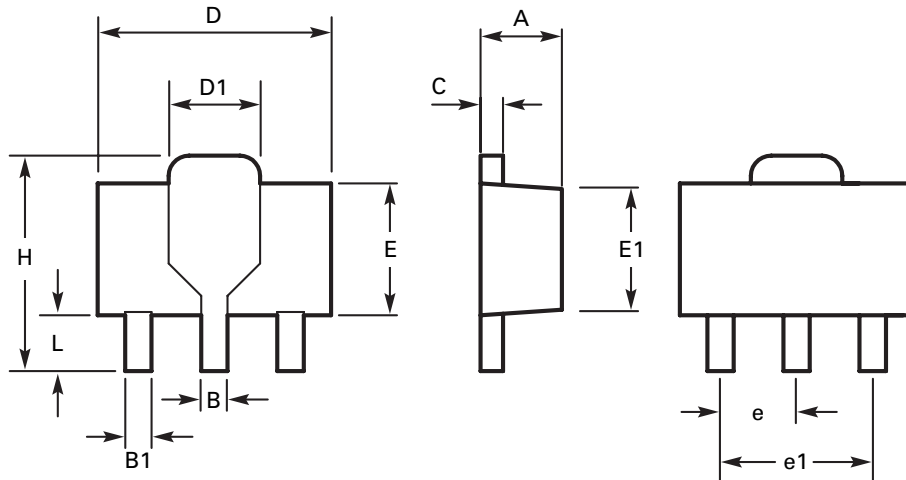

DIM	Millimeters		Inches		DIM	Millimeters		Inches	
	Min	Max	Min	Max		Min	Max	Min	Max
A	1.40	1.60	0.550	0.630	E	2.29	2.60	0.090	0.102
B	0.44	0.56	0.017	0.022	E1	2.13	2.29	0.084	0.090
B1	0.36	0.48	0.014	0.019	e	1.50 BSC		0.059 BSC	
C	0.35	0.44	0.014	0.017	e1	3.00 BSC		0.118 BSC	
D	4.40	4.60	0.173	0.181	H	3.94	4.25	0.155	0.167
D1	1.52	1.83	0.064	0.072	L	0.89	1.20	0.035	0.047

Note: Controlling dimensions are in millimeters. Approximate dimensions are provided in inches

Europe	Americas	Asia Pacific	Corporate Headquarters
Zetex GmbH Kustermann-park Balanstraße 59 D-81541 München Germany Telefon: (49) 89 45 49 49 0 Fax: (49) 89 45 49 49 49 europe.sales@zetex.com	Zetex Inc 700 Veterans Memorial Highway Hauppauge, NY 11788 USA Telephone: (1) 631 360 2222 Fax: (1) 631 360 8222 usa.sales@zetex.com	Zetex (Asia Ltd) 3701-04 Metroplaza Tower 1 Hing Fong Road, Kwai Fong Hong Kong Telephone: (852) 26100 611 Fax: (852) 24250 494 asia.sales@zetex.com	Zetex Semiconductors plc Zetex Technology Park, Chadderton Oldham, OL9 9LL United Kingdom Telephone: (44) 161 622 4444 Fax: (44) 161 622 4446 hq@zetex.com

For international sales offices visit www.zetex.com/offices

Zetex products are distributed worldwide. For details, see www.zetex.com/salesnetwork

This publication is issued to provide outline information only which (unless agreed by the company in writing) may not be used, applied or reproduced for any purpose or form part of any order or contract or be regarded as a representation relating to the products or services concerned. The company reserves the right to alter without notice the specification, design, price or conditions of supply of any product or service.