



2N7002

MOSFET

N-CHANNEL ENHANCEMENT MODE FIELD EFFECT TRANSISTOR

DESCRIPTION

The UTC **2N7002** has been designed to minimize on-state resistance while provide rugged, reliable, and fast switching performance. It can be used in most applications requiring up to 400mA DC and can deliver pulsed currents up to 2A. The product is particularly suited for low voltage, low current applications such as small servo motor control, power MOSFET gate drivers, and other switching applications

FEATURES

- * High density cell design for low $R_{DS(ON)}$.
- * Voltage controlled small signal switch
- * Rugged and reliable
- * High saturation current capability

MARKING

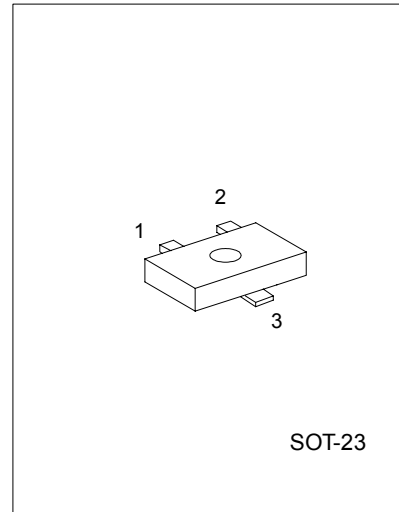
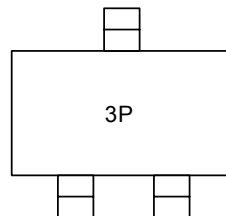

SOT-23

*Pb-free plating product number: 2N7002L

PIN CONFIGURATION

PIN NO.	PIN NAME
1	SOURCE
2	GATE
3	DRAIN

ORDERING INFORMATION

Order Number		Package	Packing
Normal	Lead free		
2N7002-AE3-R	2N7002L-AE3-R	SOT-23	Tape Reel

■ ABSOLUTE MAXIMUM RATINGS (Ta=25°C unless otherwise noted.)

PARAMETER	SYMBOL	RATINGS	UNIT
Drain-Source Voltage	V _{DSS}	60	V
Drain-Gate Voltage (R _{GS} ≤ 1MΩ)	V _{DGR}	60	V
Gate Source Voltage	Continuous	±20	V
	Non Repetitive (tp < 50μs)	±40	
Maximum Drain Current	Continuous	115	mA
	Pulsed	800	
Maximum Power Dissipation Derated above 25°C	P _D	200	mW
		1.6	mW/°C
Operating Temperature	T _{OPR}	0 ~ +70	°C
Storage Temperature	T _{STG}	-40 ~ +150	

■ THERMAL CHARACTERISTICS

PARAMETER	SYMBOL	RATINGS	UNIT
Thermal Resistance, Junction to Ambient	θ _{JA}	625	°C/W

■ ELECTRICAL CHARACTERISTICS (T_A=25°C, unless otherwise specified.)

PARAMETER	SYMBOL	TEST CONDITIONS	MIN	TYP	MAX	UNIT
OFF CHARACTERISTICS						
Drain-Source Breakdown Voltage	BV _{DSS}	V _{GS} =0V, I _D =10μA	60			V
Zero Gate Voltage Drain Current	I _{DSS}	V _{DS} =60V, V _{GS} =0V T _J =125°C			0.5	mA
					1	μA
Gate-Body leakage, Forward	I _{GSSF}	V _{GS} =20V, V _{DS} =0V			100	nA
Gate-Body leakage Reverse	I _{GSSR}	V _{GS} =-20V, V _{DS} =0V			-100	nA
ON CHARACTERISTICS (Note)						
Gate Threshold Voltage	V _{GS(th)}	V _{GS} = V _{DS} , I _D =250μA	1	2.1	2.5	V
Drain-Source On-Voltage	V _{DS(ON)}	V _{GS} = 10V, I _D =500mA V _{GS} = 5.0V, I _D =50mA		0.6	3.75	V
				0.09	1.5	
On-State Drain Current	I _{D(ON)}	V _{GS} =10V, V _{DS} ≥2V _{DS(ON)}	500	2700		mA
Static Drain-Source On-Resistance	R _{DS(ON)}	V _{GS} = 10V, I _D =500mA T _J =100°C		1.2	7.5	Ω
				1.7	13.5	
				1.7	7.5	
		V _{GS} = 5.0V, I _D =50mA T _J =100°C		2.4	13.5	
Forward Transconductance	g _{FS}	V _{DS} ≥2V _{DS(ON)} , I _D =200mA	80	320		mS
DYNAMIC CHARACTERISTICS						
Input Capacitance	C _{ISS}	V _{DS} =25V, V _{GS} =0V, f=1.0MHz		20	50	pF
Output Capacitance	C _{OSS}			11	25	pF
Reverse Transfer Capacitance	C _{RSS}			4	5	pF
Turn-On Time	t _{ON}	V _{DD} =30V, R _L =150Ω I _D =200mA, V _{GS} =10V R _{GEN} =25Ω			20	nS
Turn-Off Time	t _{OFF}	V _{DD} =30V, R _L =25Ω I _D =200mA, V _{GS} =10V R _{GEN} =25Ω			20	nS
DRAIN-SOURCE DIODE CHARACTERISTICS AND MAXIMUM RATINGS						
Drain-Source Diode Forward Voltage	V _{SD}	V _{GS} =0V, I _S =115mA (Note)		0.88	1.5	V
Maximum Pulsed Drain-Source Diode Forward Current	I _{SM}				0.8	A
Maximum Continuous Drain-Source Diode Forward Current	I _S				115	mA

Note: Pulse Test: Pulse Width ≤ 300μs, Duty Cycles ≤ 2.0%



■ TEST CIRCUIT AND WAVEFORM

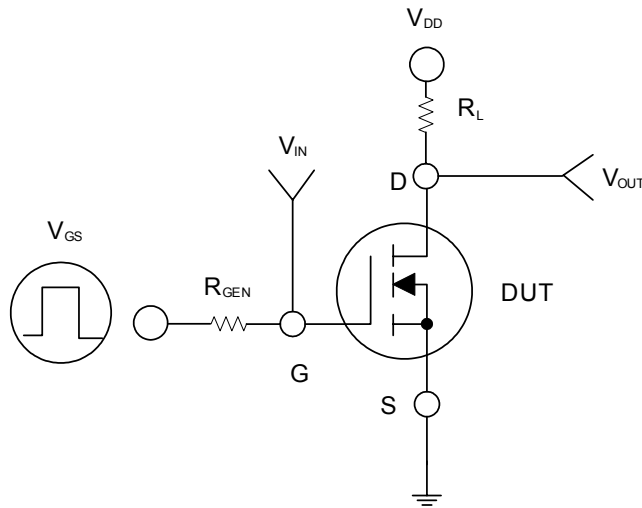

Figure 1

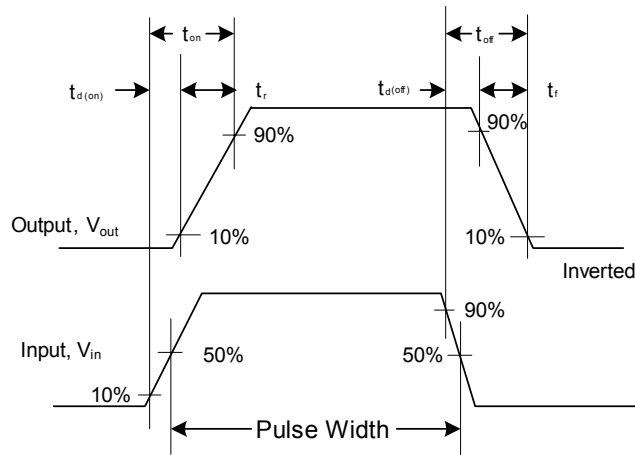

Figure 2. Switching Waveforms

■ TYPICAL CHARACTERISTICS

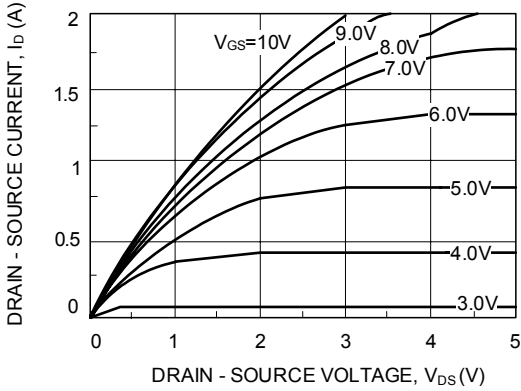

Figure 3. On-Region Characteristics

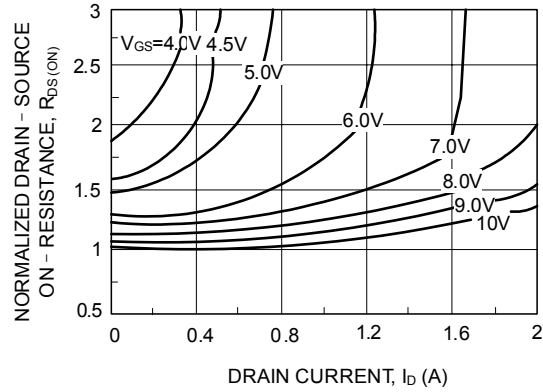

Figure 4. On-Resistance Variation with Gate Voltage and Drain Current

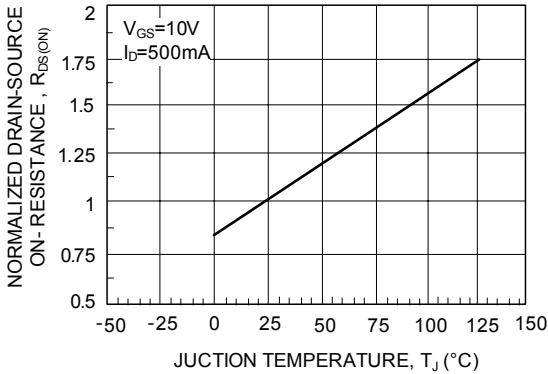

Figure 5. On-Resistance Variation with Temperature

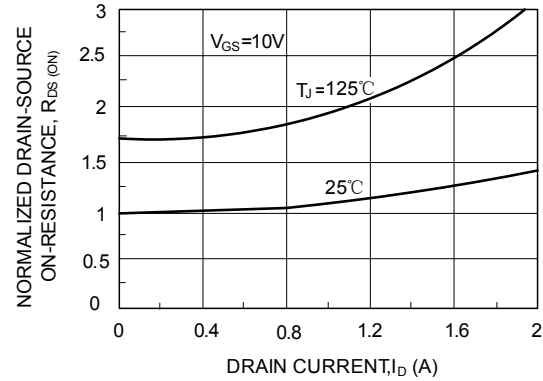

Figure 6. On-Resistance Variation with Drain Current and Temperature

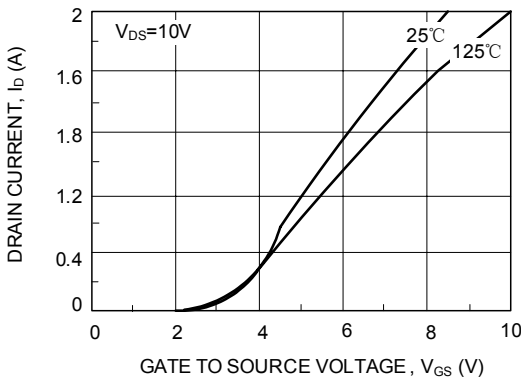

Figure 7. Transfer Characteristics

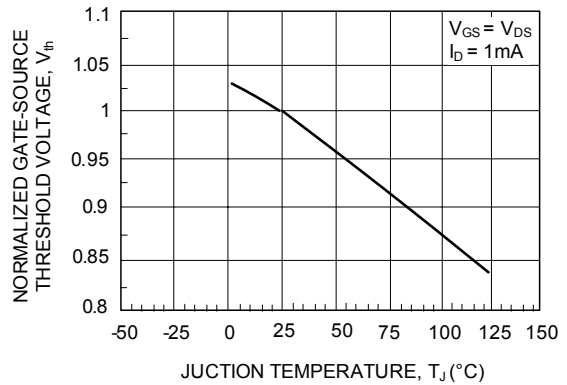

Figure 8. Gate Threshold Variation with Temperature

■ TYPICAL CHARACTERISTICS (cont.)

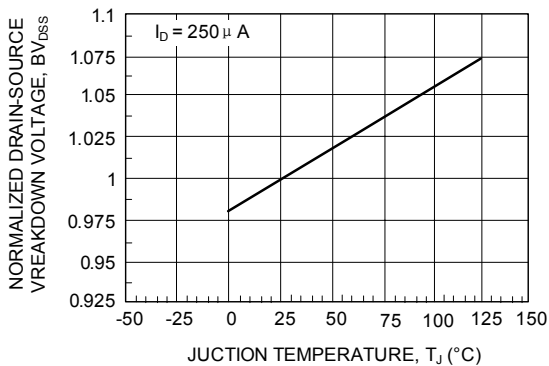

Figure 9. Breakdown Voltage Variation with Temperature

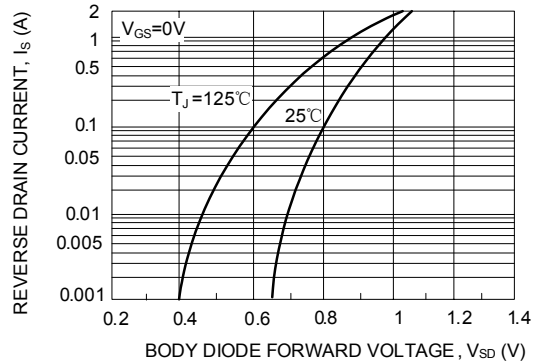

Figure 10. Body Diode Forward Voltage Variation with Temperature

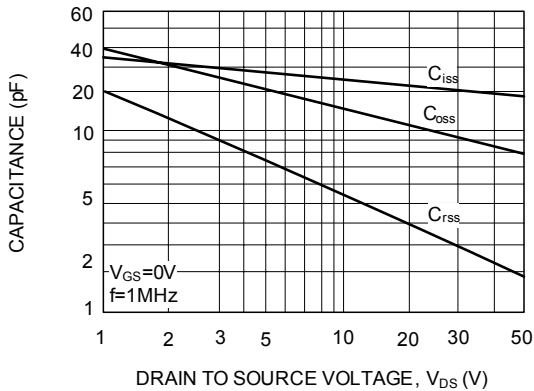

Figure 11. Capacitance Characteristics

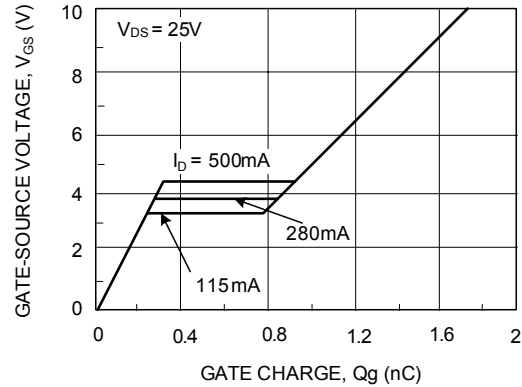

Figure 12. Gate Charge Characteristics

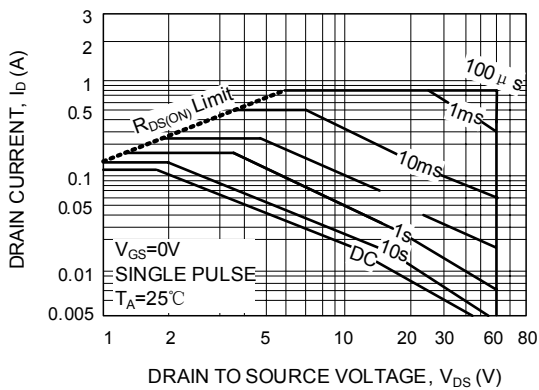

Figure 13. Maximum Safe Operating Area

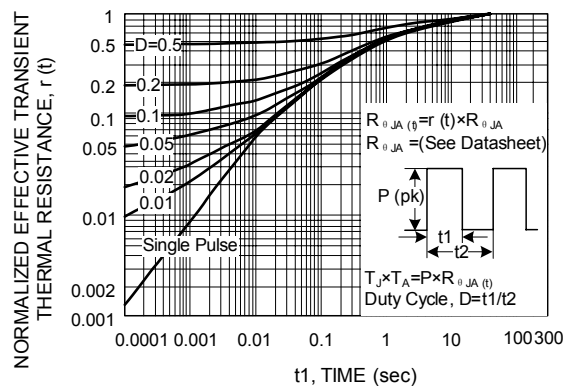

Figure 14. Transient Thermal Response Curve

UTC assumes no responsibility for equipment failures that result from using products at values that exceed, even momentarily, rated values (such as maximum ratings, operating condition ranges, or other parameters) listed in products specifications of any and all UTC products described or contained herein. UTC products are not designed for use in life support appliances, devices or systems where malfunction of these products can be reasonably expected to result in personal injury. Reproduction in whole or in part is prohibited without the prior written consent of the copyright owner. The information presented in this document does not form part of any quotation or contract, is believed to be accurate and reliable and may be changed without notice.

