



# 2SC2712

## NPN SILICON TRANSISTOR

### AUDIO FREQUENCY AMPLIFIER NPN TRANSISTOR

#### FEATURES

- \* High Voltage and High Current  
:  $V_{CE0}=50V, I_C=150mA$  (Max.)
- \* Excellent  $h_{FE}$  Linearity  
:  $h_{FE}(I_C=0.1mA)/h_{FE}(I_C=2mA)=0.95$ (Typ.)
- \* High  $h_{FE}$
- \* Low Noise

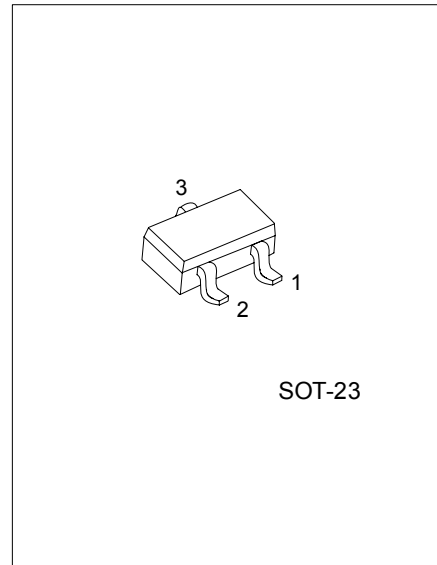

SOT-23

\*Pb-free plating product number: 2SC2712L

#### ORDERING INFORMATION

Order Number		Package	Pin Assignment			Packing
Normal	Lead Free Plating		1	2	3	
2SC2712-x-AE3-R	2SC2712L-x-AE3-R	SOT-23	E	B	C	Tape Reel

<p>2SC2712L-x-AE3-R</p> <p>(1)Packing Type (2)Package Type (3)Rank (4)Lead Plating</p>	<p>(1) R: Tape Reel (2) AE3: SOT-23 (3) x: refer to Classification of <math>h_{FE}</math> (4) L: Lead Free Plating, Blank: Pb/Sn</p>
--	--

#### MARKING

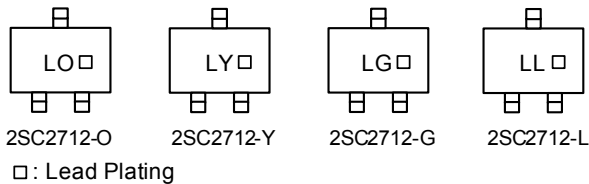

■ ABSOLUTE MAXIMUM RATINGS (Ta=25 )

PARAMETER	SYMBOL	RATINGS	UNIT
Collector-Base Voltage	$V_{CBO}$	60	V
Collector-Emitter Voltage	$V_{CEO}$	50	V
Emitter-Base Voltage	$V_{EBO}$	5	V
Collector Current	$I_C$	150	mA
Base Current	$I_B$	30	mA
Collector Power Dissipation	$P_C$	150	mW
Junction Temperature	$T_J$	+125	
Storage Temperature	$T_{STG}$	-55 ~ +125	

Note: Absolute maximum ratings are those values beyond which the device could be permanently damaged. Absolute maximum ratings are stress ratings only and functional device operation is not implied.

■ ELECTRICAL CHARACTERISTICS (Ta=25 )

PARAMETER	SYMBOL	TEST CONDITIONS	MIN	TYP	MAX	UNIT
Collector Cut-off Current	$I_{CBO}$	$V_{CB}=60V, I_E=0$			0.1	$\mu A$
Emitter Cut-off Current	$I_{EBO}$	$V_{EB}=5V, I_C=0$			0.1	$\mu A$
DC Current Gain	$h_{FE}$	$V_{CE}=6V, I_C=2mA$	70		700	
Collector-Emitter Saturation Voltage	$V_{CE(SAT)}$	$I_C=100mA, I_B=10mA$		0.1	0.25	V
Transistor Frequency	$f_T$	$V_{CE}=10V, I_C=1mA$	80			MHz
Collector Output Capacitance	$C_{ob}$	$V_{CB}=10V, I_E=0, f=1MHz$		2.0	3.5	pF
Noise Figure	NF	$V_{CE}=6V, I_C=0.1mA$ $f=1kHz, R_g=10K\Omega$		1.0	10	dB

■ CLASSIFICATION OF  $h_{FE}$

RANK	O	Y	G	L
RANGE	70~140	120~240	200~400	350~700

■ TYPICAL CHARACTERISTICS

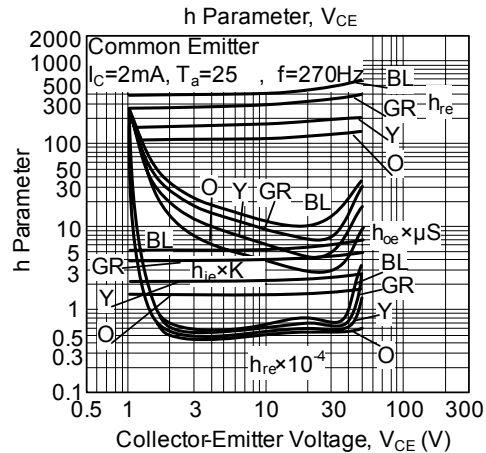
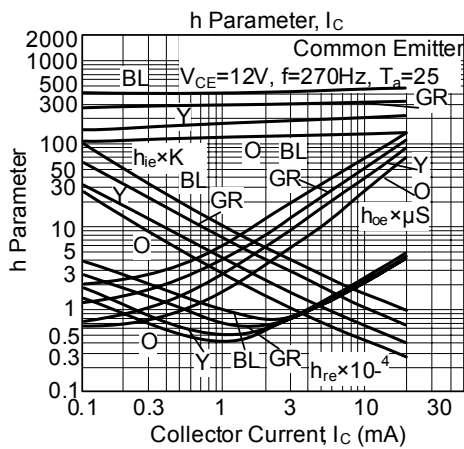
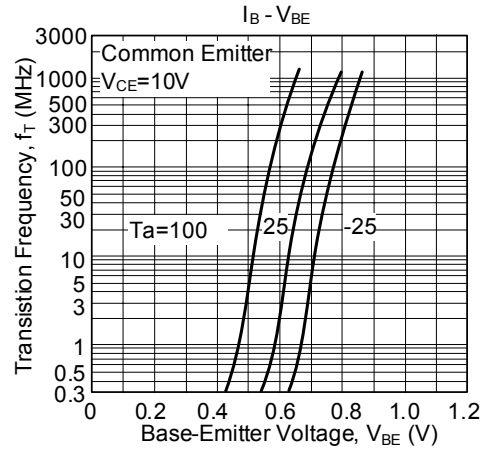
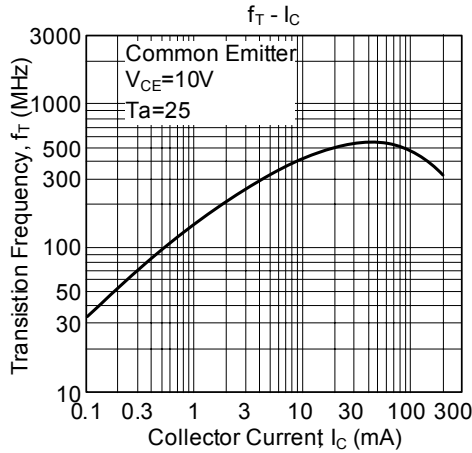
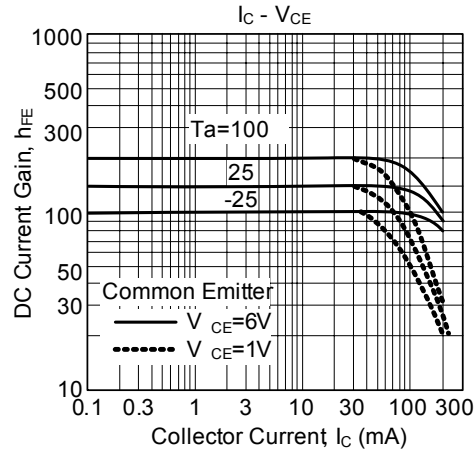
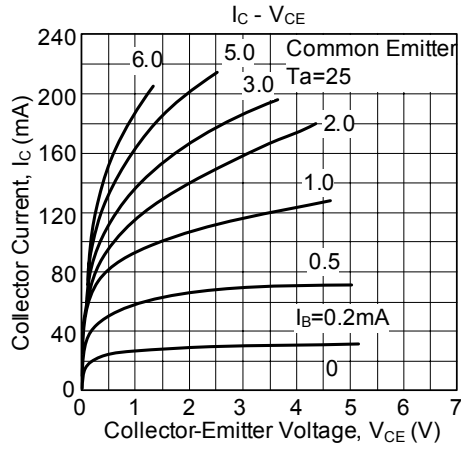

## ■ TYPICAL CHARACTERISTICS(Cont.)

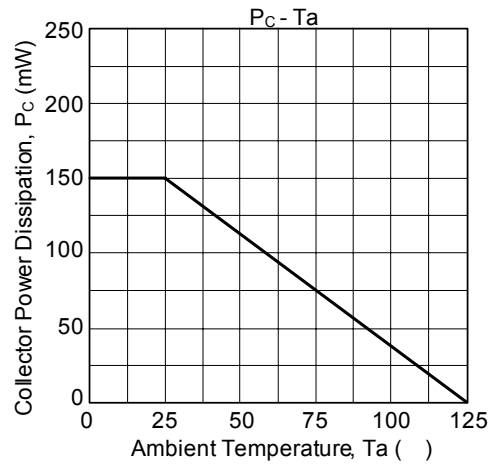

UTC assumes no responsibility for equipment failures that result from using products at values that exceed, even momentarily, rated values (such as maximum ratings, operating condition ranges, or other parameters) listed in products specifications of any and all UTC products described or contained herein. UTC products are not designed for use in life support appliances, devices or systems where malfunction of these products can be reasonably expected to result in personal injury. Reproduction in whole or in part is prohibited without the prior written consent of the copyright owner. The information presented in this document does not form part of any quotation or contract, is believed to be accurate and reliable and may be changed without notice.