

PNP Silicon Transistors with High Reverse Voltage

BFP 23
BFP 26

- High breakdown voltage
- Low collector-emitter saturation voltage
- Low capacitance
- Complementary types: BFP 22, BFP 25 (NPN)

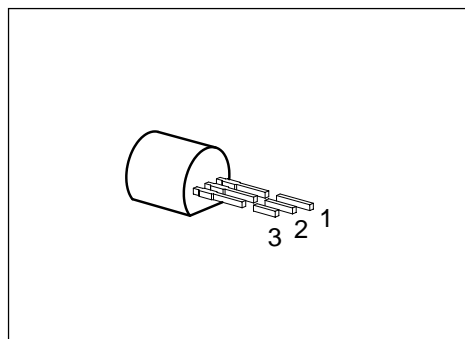

Type	Marking	Ordering Code (tape and reel)	Pin Configuration			Package ¹⁾
			1	2	3	
BFP 23 BFP 26	–	Q62702-F622 Q62702-F722	E	B	C	TO-92

Maximum Ratings

Parameter	Symbol	Values		Unit
		BFP 23	BFP 26	
Collector-emitter voltage	V_{CE0}	200	300	V
Collector-base voltage	V_{CB0}	200	300	
Emitter-base voltage	V_{EB0}	6		
Collector current	I_C	200		mA
Peak collector current	I_{CM}	500		
Base current	I_B	100		
Peak base current	I_{BM}	200		
Total power dissipation, $T_C = 66\text{ °C}$	P_{tot}	625		mW
Junction temperature	T_j	150		°C
Storage temperature range	T_{stg}	– 65 ... + 150		

Thermal Resistance

Junction - ambient	$R_{th\ JA}$	≤ 200	K/W
Junction - case ²⁾	$R_{th\ JC}$	≤ 135	

1) For detailed information see chapter Package Outlines.

2) Mounted on Al heat sink 15 mm × 25 mm × 0.5 mm.

Electrical Characteristics

at $T_A = 25\text{ °C}$, unless otherwise specified.

Parameter	Symbol	Values			Unit
		min.	typ.	max.	

DC characteristics

Collector-emitter breakdown voltage $I_C = 1\text{ mA}$	BFP 23 BFP 26	$V_{(BR)CE0}$	200 300	– –	– –	V
Collector-base breakdown voltage $I_C = 100\text{ }\mu\text{A}$	BFP 23 BFP 26	$V_{(BR)CB0}$	200 300	– –	– –	
Emitter-base breakdown voltage $I_E = 100\text{ }\mu\text{A}$		$V_{(BR)EB0}$	6	–	–	
Collector-base cutoff current $V_{CB} = 160\text{ V}$ $V_{CB} = 250\text{ V}$ $V_{CB} = 160\text{ V}, T_A = 150\text{ °C}$ $V_{CB} = 250\text{ V}, T_A = 150\text{ °C}$	BFP 23 BFP 26 BFP 23 BFP 26	I_{CBO}	– – – –	– – – –	100 100 20 20	nA nA μA μA
Emitter-base cutoff current $V_{EB} = 3\text{ V}$		I_{EB0}	–	–	100	nA
DC current gain $I_C = 1\text{ mA}, V_{CE} = 10\text{ V}$ $I_C = 10\text{ mA}, V_{CE} = 10\text{ V}^{1)}$ $I_C = 30\text{ mA}, V_{CE} = 10\text{ V}^{1)}$	BFP 23 BFP 26	h_{FE}	25 40 30 25	– – – –	– – – –	–
Collector-emitter saturation voltage ¹⁾ $I_C = 20\text{ mA}, I_B = 2\text{ mA}$	BFP 23 BFP 26	V_{CEsat}	– –	– –	0.4 0.5	V
Base-emitter saturation voltage ¹⁾ $I_C = 20\text{ mA}, I_B = 2\text{ mA}$		V_{BEsat}	–	–	0.9	

AC characteristics

Transition frequency $I_C = 20\text{ mA}, V_{CE} = 10\text{ V}, f = 20\text{ MHz}$		f_T	–	70	–	MHz
Output capacitance $V_{CB} = 30\text{ V}, f = 1\text{ MHz}$		C_{obo}	–	1.5	–	pF

¹⁾ Pulse test conditions: $t \leq 300\text{ }\mu\text{s}$, $D \leq 2\%$.

Total power dissipation $P_{tot} = f(T_A; T_C)$

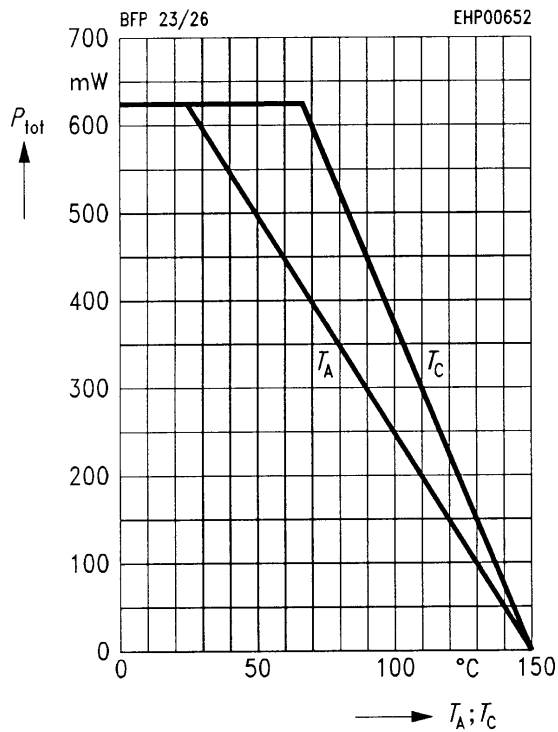

Operating range $I_C = f(V_{CE})$

$D = 0, T_A = 25$ °C

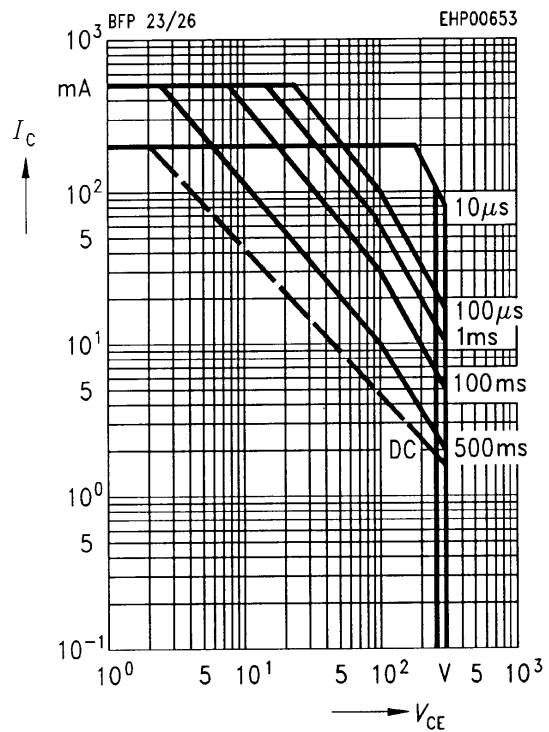

Permissible pulse load $R_{thJA} = f(t_p)$

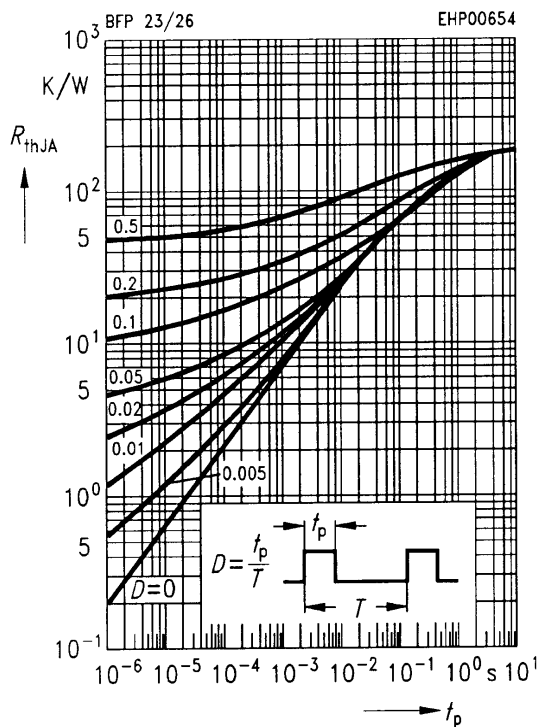

Collector current $I_C = f(V_{BE})$

$V_{CE} = 10$ V, $T_A = 25$ °C

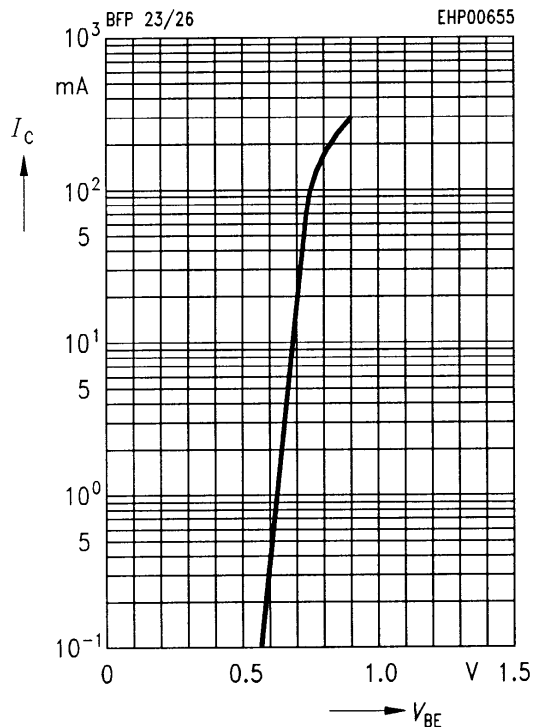

Collector cutoff current $I_{CB0} = f(T_A)$
 $V_{CB} = 160 \text{ V}, 250 \text{ V}$

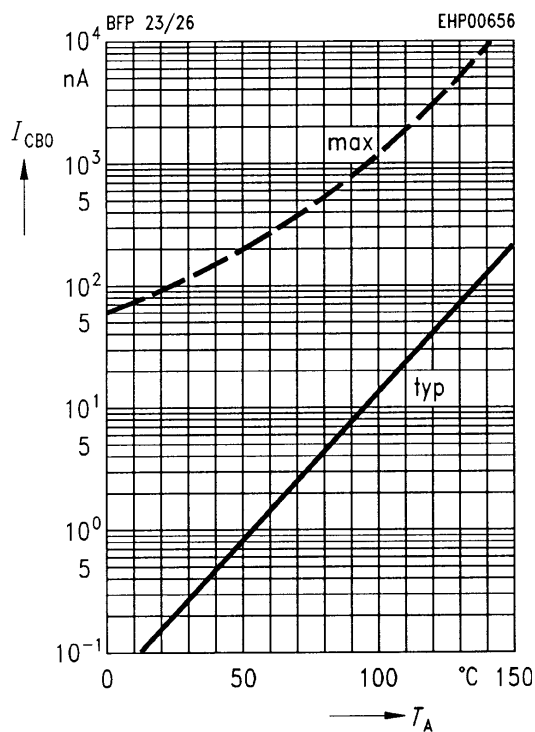

DC current gain $h_{FE} = f(I_C)$
 $V_{CE} = 10 \text{ V}, T_A = 25 \text{ °C}$

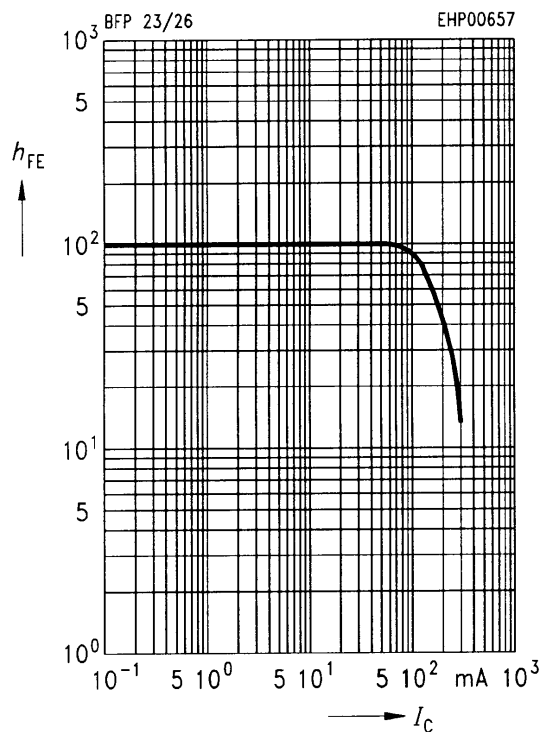

Transition frequency $f_T = f(I_C)$
 $V_{CE} = 10 \text{ V}, f = 20 \text{ MHz}$

