

#### Features

- Step-down Switching Regulator with very high Efficiency (> 92%)
- 1.8 – 3.3 VDC or 5.0 VDC Output, up to 2.0 A
- Remote ON/OFF
- Overload Protection
- Low Output Noise
- Standby Current only 100 µA
- Small SIL-, DIP- or SMD-Package
- 2 Year Product Warranty

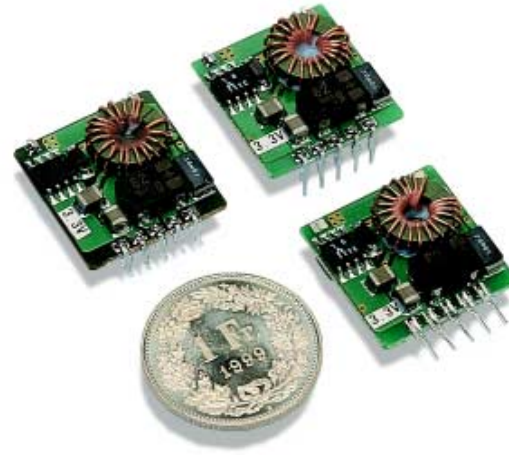

This new generation of step-down converters provides designers with a cost-effective solution for converting a 5 VDC resp. 12 VDC voltage down to 1.8 – 3.3 VDC or to 5 VDC. To achieve highest efficiency, these dc/dc converters are using newest technologies, as amorphous ferrite, solid aluminum capacitors and a synchronous commutation IC.

The TSI-10 series needs no further external components to operate within its specifications. A very high efficiency allows operation without additional heatsink. This product finds many applications in distributed powersystems where voltage conversion at the point of load is an advantage.

Models					
Ordercode	Input voltage range	Output voltage	Output current max.	Efficiency typ.	Package
TSI-3.3S2R0M TSI-3.3S2R0FM TSI-3.3S2R0SM	4.75 – 13.6 VDC	* + 3.3 VDC	2000 mA	92.0 %	SIP DIP SMD
TSI-5.0S2R0M TSI-5.0S2R0FM TSI-5.0S2R0SM	6.0 – 16.5 VDC	** + 5.0 VDC	2000 mA	93.0 %	SIP DIP SMD

\* Output adjustable 1.8 to 3.3 VDC

\*\* Output adjustable 3.0 to 5.0 VDC

### Input Specifications

Input current (no load)	all models	2 mA max.
Input current (at full load)	TSI-3.3S2 models TSI-5.0S2 models	1410 mA max. (5 Vin) 890 mA max. (12 Vin)

Stand-by current	100 µA max.
------------------	-------------

### Output Specifications

Voltage adjustment	TSI-3.3S2 models TSI-5.0S2 models	+1.8 VDC to +3.3 VDC +3.0 VDC to +5.0 VDC
--------------------	--------------------------------------	--

Regulation	– Input variation – Load variation 0 – 100 %	± 0.5 % < 1.5 %
------------	---	--------------------

Ripple and noise (20 MHz Bandwidth)	50 mVpk-pk max.
-------------------------------------	-----------------

Transient response time	TSI-3.3S2 models  TSI-5.0S2 models	50% Load change: 100 µsec typ. Vout over-/undershoot: 70 mV typ. 50% Load change: 100 µsec typ. Vout over-/undershoot: 80 mV typ.
-------------------------	--	--

Temperature coefficient	± 0.01 % / °C
-------------------------	---------------

Short circuit protection	constant current >105%
--------------------------	------------------------

Remote ON/OFF control	ON=Pin 1 (ON/OFF Pin) to pin 3 (GND) open OFF=Pin 1 (ON/OFF Pin) to pin 3 (GND) short
-----------------------	--

### General Specifications

Temperature ranges	– Operating – Storage Derating above 50°C	– 25 °C ... +70 °C – 25 °C ... +85 °C 3 % / °C
--------------------	---	--

Humidity (non condensing)	95 % rel H max.
---------------------------	-----------------

Reliability, calculated MTBF (MIL-HDBK-217 E)	>1'000'000 h @ 50 °C
---	----------------------

Isolation Input/Output	none
------------------------	------

Switching frequency	200 kHz typ. (PWM modulation)
---------------------	-------------------------------

### Physical Specifications

Vibration	5 to 10 Hz amplitude 10 mm pk-pk 10 to 55 Hz acceleration 2 G
-----------	--

Shock	acceleration 20 G max. time 11 ms
-------	-----------------------------------

Package weight	6 g
----------------	-----

Soldering temperature	max. 235°C max. / 10 sec.
-----------------------	---------------------------

All specifications valid at nominal input voltage, full load and +25°C after warm-up time unless otherwise stated.

**Outline Dimensions mm (inches)**

**SIP package**

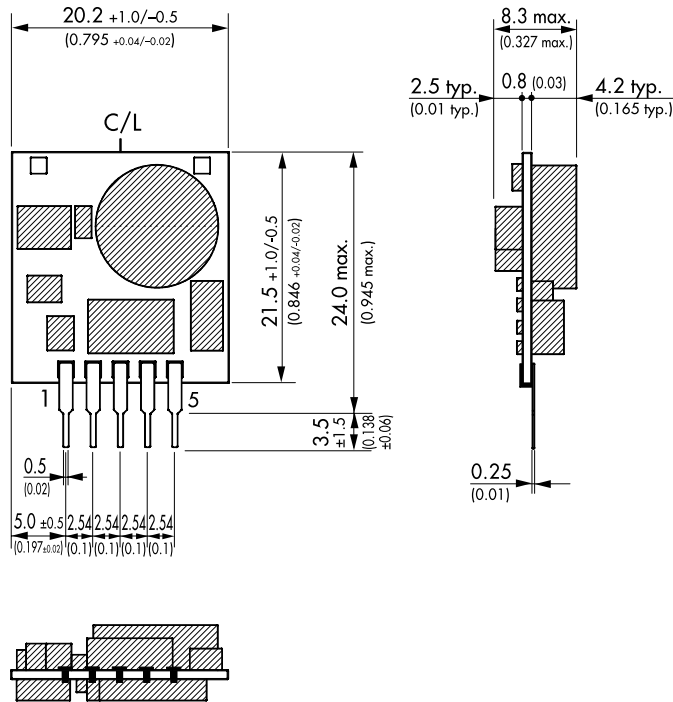

**DIP package**

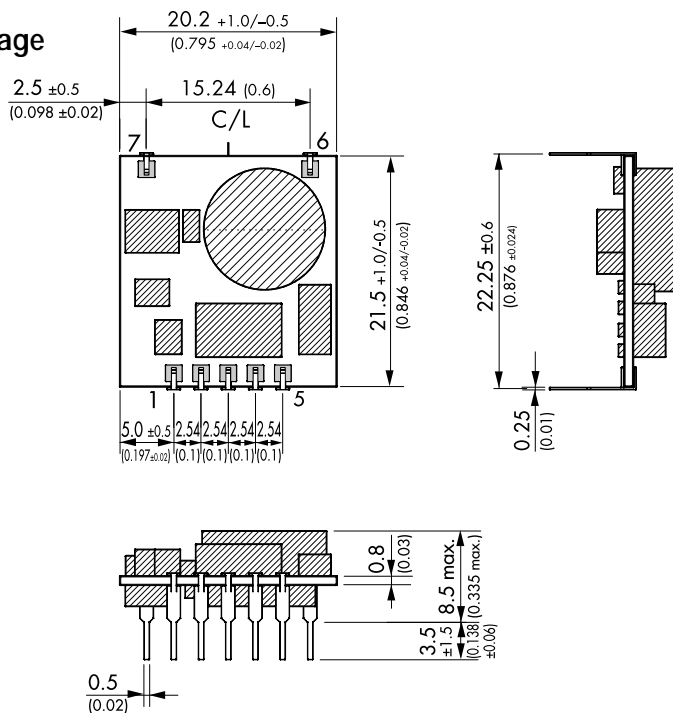

**Pin-Out**

Pin	DIP	SIP
1	Remote on/off	Remote on/off
2	+V Input (Vcc)	+V Input (Vcc)
3	-V Input (GND)	-V Input (GND)
4	+V Output	+V Output
5	V Output adj	V Output adj
6	No function	No pin
7	No function	No pin

Specifications can be changed without notice

**Outline Dimensions mm (inches)**

**SMD package**

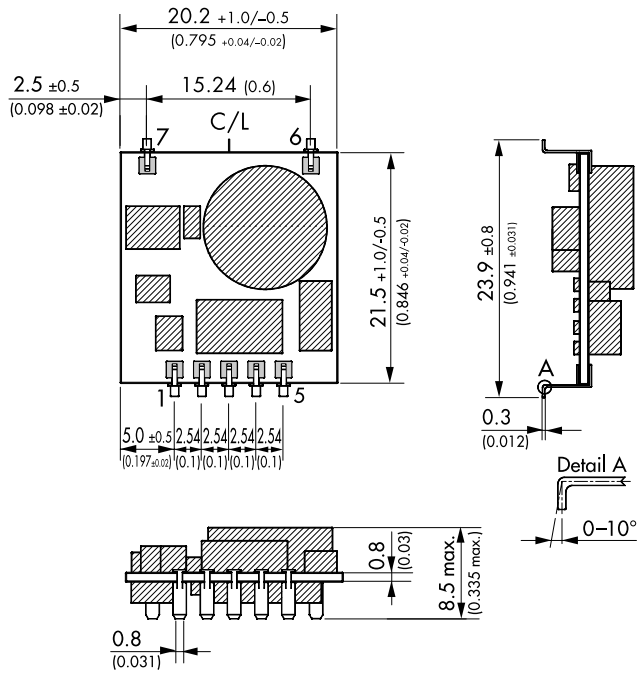

**Pin-Out**

Pin	SMD
1	Remote on/off
2	+V Input (Vcc)
3	-V Input (GND)
4	+V Output
5	V Output adj
6	No function
7	No function

**Solder Pad**

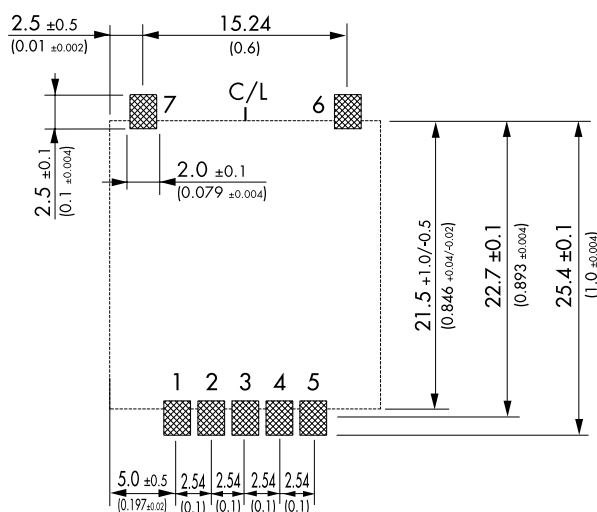

Specifications can be changed without notice

**Connections**

Normal Connection (Standard)

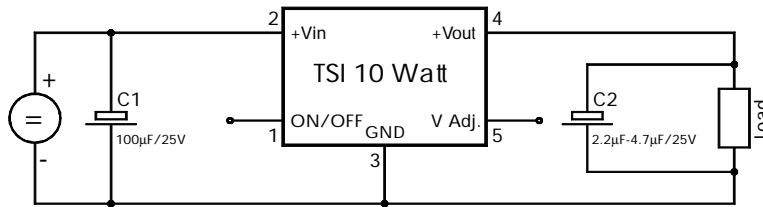

Remote ON/OFF Connection

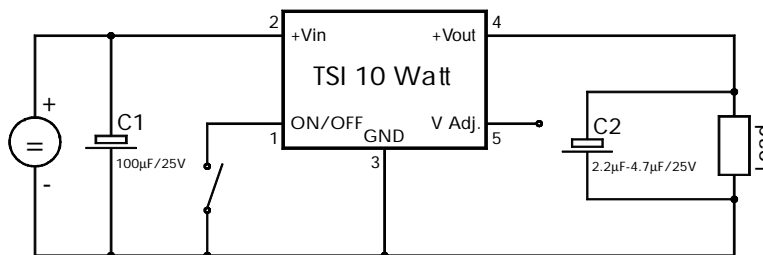

Output Voltage Adjustment Connection

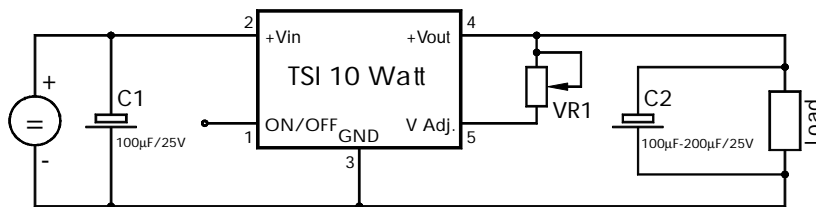

$$VR1 = \frac{Rx \cdot 1200 \cdot (Vo - 1.195)}{Rx \cdot 1.195 - 1200 \cdot (Vo - 1.195)}$$

TSI-3.3SxROx ==> Rx = 2130 Ohm  
Output Voltage = 1.8 - 3.3VDC

TSI-5.0SxROFx ==> Rx = 3840 Ohm  
Output Voltage = 3.0 - 5.0VDC

Vo = adjusted ooutput voltage

Specifications can be changed without notice