

ILC6360

Step-Up/Step Down DC-DC Converter for
1-Cell Lithium-Ion Batteries



General Description

The ILC6360 step-up/step-down DC-DC converter is a switch mode converter, capable of supplying up to 500mA output current, at a fixed or user selectable output voltage. The range of input, and output voltage options makes the ILC6360 ideal for Lithium-ion (Li-ion), or any other battery application, where the input voltage range spans above and below the regulated output voltage. When ILC6360's input voltage exceeds the output voltage by more than 800mV, the output will begin to track the input linearly.

Configured as a 300kHz, fixed frequency PWM boost converter, the ILC6360 performs the buck operation by seamlessly switching to PFM, when the output voltage rises near the positive range of regulation. However, since the transition point between PWM and PFM mode is dependent upon both line, and load regulation, under certain conditions, regulation will remain in PWM mode even in the buck mode of operation.

The ILC6360 is unconditionally stable with no external compensation; the sizes of the input and output capacitors influence the ripple on the input, and output voltages. Since the ILC6360 has an internal synchronous rectifier, the standard fixed voltage version requires minimal external components: an inductor, an input capacitor, and an output capacitor. An additional 10µF ceramic output capacitor will help reduce output ripple voltage.

Other features include an external sync input for synchronizing the PWM frequency, low battery input detector with 100ms transient rejection delay built-in, and, a power good indicator useful as a system power on reset.

Features

- ILC6360CIR-36: Fixed 3.6V output; custom voltages possible
- ILC6360CIR-ADJ: Adjustable output to 6V maximum
- Capable of 500mA output current
- Peak efficiency: > 90% at $V_{OUT} = 3.6V, I_{OUT} = 300mA, V_{IN} = 3.6V$
- No external diode is required (synchronous rectification)
- Battery input current of 250mA at no load
- True load disconnect from battery input in shutdown (1mA)
- OSC freq: 300kHz $\pm 15\%$
- External freq synchronization from 150kHz to 500kHz
- Low battery detector with 100ms transient rejection delay
- Power good output flag when V_{OUT} is in regulation
- MSOP-8 package

Applications

- Cellular phones
- Palmtops, PDAs and portable electronics
- Equipment using single Lithium-Ion batteries

Optimized to Maximize Battery Life

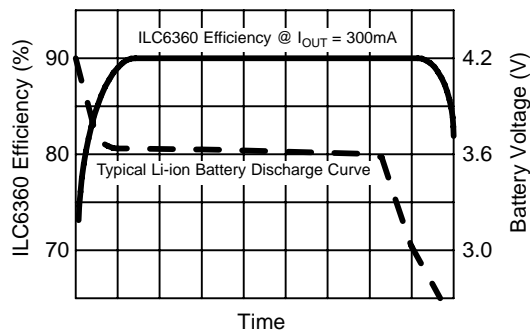

Typical Performance Characteristics for 1-cell Li-ion

Patent Pending

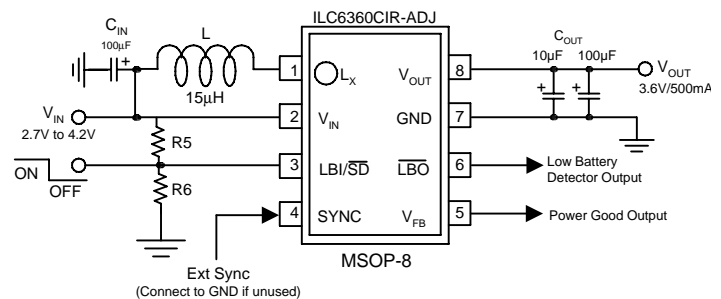

Typical Step-up/Step-down Application Circuit
(Note: R5 and R6 are required only if LBI feature is used)

Pin Functions ILC6360CIR-36

Pin Number	Pin Name	Pin Description
1	L_x	Inductor input. Inductor L connected between this pin and the battery
2	V_{IN}	Connect directly to battery
3	$\overline{LBI/SD}$	Low battery detect input and shutdown. Low battery detect threshold is set with this pin using a potential divider. If this pin is pulled to logic low then the device will shutdown.
4	SYNC	A logic level signal referenced to V_{IN} , at a frequency between 150kHz and 500kHz on this pin will over-ride the internal 300kHz oscillator. If the SYNC function is unused, pin 4 should be connected to ground
5	\overline{POK} (ILC6382CIR-XX)	This open drain output pin will go high when output voltage is within regulation, $0.92 \cdot V_{OUT(NOM)} \leq V_{OUT} \leq 0.98 \cdot V_{OUT(NOM)}$
	V_{FB} (ILC6382CIR-ADJ)	This pin sets the adjustable output voltage via an external resistor divider network. The formula for choosing the resistors is shown in the "Applications Information" section.
6	\overline{LBO}	This open drain output will go low if the battery voltage is below the low battery threshold set at pin 3
7	GND	Connect this pin to the battery and system ground
8	V_{OUT}	This is the regulated output voltage

PIN-PACKAGE CONFIGURATIONS

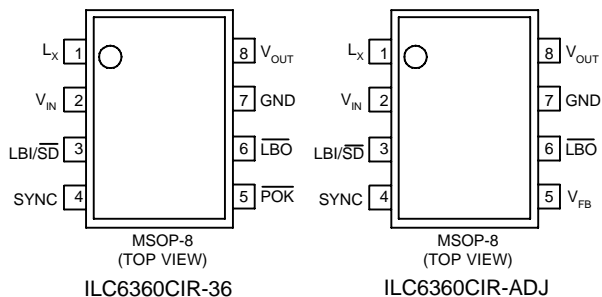

Ordering Information ($T_A = -40^\circ\text{C}$ to $+85^\circ\text{C}$)

ILC6360CIR-36	3.6V output, MSOP-8 package
ILC6360CIR-ADJ	Adjustable output, MSOP-8 package

Absolute Maximum Ratings (Note 1)

Parameter	Symbol	Ratings	Units
Voltage on V _{OUT} pin	V _{OUT}	-0.3 to 7	V
Voltage on LBI, Sync, LBO, POK, LBI/SD, V _{FB} , L _X and V _{IN} pins	-	-0.3 to 7	V
Peak switch current on L _X pin	I _{L_X}	1	A
Current on LBO pin	I _{sink(LBO)}	5	mA
Continuous total power dissipation at 85°C	P _d	400	mW
Short circuit duration	I _{SC}	1	sec
Operating ambient temperature	T _A	-40 to 85	°C
Maximum junction temperature	T _{J (max)}	170	°C
Storage temperature	T _{stg}	-40 to 125	°C
Lead temperature (soldering 10 sec)		300	°C
Package thermal resistance	θ _{JA}	206	°C/W

Electrical Characteristics ILC6360CIR-36 and ILC6360CIR-ADJ

Unless otherwise specified all limits are at T_A = 25°C, V_{IN} = 3.6V, V_{OUT} = 3.6V, V_{LBI} = 1.5V, I_{OUT} = 1mA, F_{OSC} = 300kHz. Test circuit of figure 2 for ILC6360-36 and test circuit of figure 9 for ILC6360-ADJ. **BOLDFACE** type indicates limits that apply over the full operating temperature range. **Note 2.**

Parameter	Symbol	Conditions	Min	Typ	Max	Units
Input Voltage	V _{IN}	V _{OUT} = V _{OUT(nominal)} ± 4% (Note 3)	2.7		V _{OUT (nom)} +0.8	V
Output Voltage	V _{OUT}	2.8V ≤ V _{IN} ≤ 4.2V, I _{OUT} = 0mA	3.528	3.600	3.672	V
Feedback Voltage (ILC6360-ADJ only)	V _{FB}		1.225 1.212	1.250	1.275 1.288	V
Output Voltage Adjustment Range ILC6360CIR-ADJ only	V _{OUT (adj) min} V _{OUT (adj) max}	V _{IN} = 3.3V, I _{OUT} = 50mA		2.5 6		V
Output Current	I _{OUT}	V _{IN} = 3.6V, V _{OUT} = V _{OUT(nom)} ± 4% (Note 3)		500		mA
Load Regulation	ΔV _{OUT} V _{OUT (no load)}	0mA ≤ I _{OUT} ≤ 500mA 0mA ≤ I _{OUT} ≤ 300mA 0mA ≤ I _{OUT} ≤ 200mA		4 1 1		%
Efficiency	η	I _{OUT} = 300mA		93		%
No Load Battery Input Current	I _{IN (no load)}	I _{OUT} = 0mA		250		μA

Electrical Characteristics ILC6360CIR-36 and ILC6360CIR-ADJ (Continued)

Unless otherwise specified all limits are at TA = 25°C, VIN = 3.6V, VOUT = 3.6V, VLBI = 1.5V, IOUT = 1mA, FOSC = 300kHz. Test circuit of figure 2 for ILC6360-36 and test circuit of figure 9 for ILC6360-ADJ. **BOLDFACE** type indicates limits that apply over the full operating temperature range. **Note 2**.

Parameter	Symbol	Conditions	Min	Typ	Max	Units
Battery input current in shutdown	IIN(SD)	VLBI/SD < 0.4V, VOUT = 0V (short circuit) True load disconnect		1	2	µA
Switch on resistance	Rds(on)	N-Channel MOSFET P-Channel MOSFET		400 750		mΩ
Oscillator frequency	fosc		255	300	345	kHz
External clock frequency range (sync)	fsync		150		500	kHz
External clock pulse width	tW(sync)	Note 4	200			ns
External clock rise/fall time	tr / tf	Note 4			100	ns
LBI input threshold	VREF		1.175 1.150	1.250	1.325 1.350	V
Input leakage current	I _{LEAK}	Pins LBI/SD, Sync and VFB, Note 4			200	nA
LBI hold time	t _{hold(LBI)}	Note 5	120	100		ms
LBO output voltage low	V _{LBO} (low)	ISINK = 20mA, open drain output			0.4	V
LBO output leakage current	I _{LBO} (hi)	VLBO = 5V		1	2	µA
Shutdown input voltage low	VSD(low)				0.4	V
Shutdown input voltage high	VSD(hi)	VLBO = 5V	1		6	V
Sync input voltage low	V _{SYNC} (low)				0.4	V
Sync input voltage high	VSD(hi)		1		6	V
POK output voltage low	V _{POK} (low)	ISINK = 2mA, open drain output			0.4	V
POK output voltage high	V _{POK} (hi)				6	V
POK output leakage current	I _L (POK)	Force 6V at pin 5		1	2	µA
POK threshold	V _{TH} (POK)		0.92xV _{OUT}	0.95xV _{OUT}	0.98xV _{OUT}	V
POK hysteresis	V _{HYST}			50		mV

Note 1. Absolute maximum ratings indicate limits which, when exceeded, may result in damage to the component. Electrical specifications do not apply when operating the device outside its rated operating conditions.

Note 2. Specified min/max limits are production tested or guaranteed through correlation based on statistical control methods. Measurements are taken at constant junction temperature as close to ambient as possible using low duty pulse testing.

Note 3. V_{OUT(nom)} is the nominal output voltage at I_{OUT} = 0mA.

Note 4. Guaranteed by design.

Note 5. In order to get a valid low-battery-output (LBO) signal, the input voltage must be lower than the low-battery-input (LBI) threshold for a duration greater than the low battery hold time (t_{hold(LBI)}). This feature eliminates false triggering due to voltage transients at the battery terminal.

APPLICATIONS INFORMATION

The ILC6360 performs both buck and boost DC-DC conversion by controlling the switch element as shown in the simplified circuit in figure 1 below.

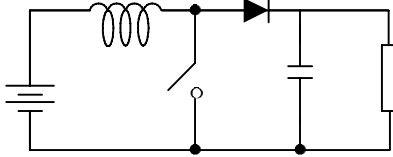

Fig. 1: Basic Circuit

When the switch is closed, current is built up through the inductor. When the switch opens, this current is forced through the diode to the output capacitor and load. As this on and off switching continues, the output capacitor voltage builds up due to the charge it is storing from the inductor current. The output voltage is therefore boosted relative to the input.

In general, the switching characteristic is determined by the output voltage desired and the current required by the load. Specifically the energy transfer is determined by the power stored in the coil during each switching cycle.

$$P_L = f(t_{ON}, V_{IN})$$

Synchronous Rectification

The ILC6360 also uses a technique called “synchronous rectification” which removes the need for the external diode used in other circuits. The diode is replaced with a second switch (SW2) or in the case of the ILC6360, a FET as shown in figure 2 below.

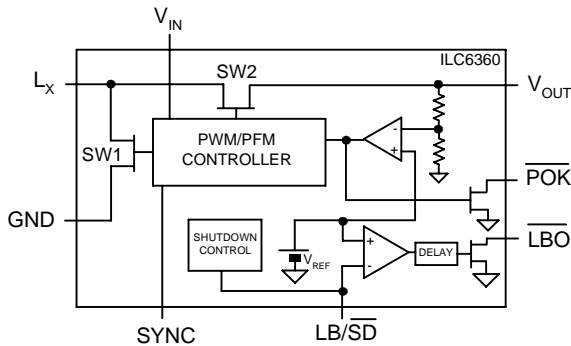

Fig. 2: Simplified ILC6360 block diagram

The two switches now open and close in opposition to each other, directing the flow of current to either charge the inductor or to feed the load. The ILC6360 monitors the voltage on the output capacitor to determine how much and how often to drive the switches.

Modes of Operation

There are four modes of operation for the ILC6360 buck/boost DC-DC converter. These four modes are internally selected by the regulator depending on external conditions such as line voltage, output voltage, load current, inductor size, output capacitor size and resistive losses.

The first mode is the discontinuous mode. If the load is light and the inductor value is small enough, the inductor will transfer all of its energy to the output capacitor before a cycle is completed. The input current waveform instead of being continuous with a triangle ripple, will be a series of discrete triangle shaped pulses as the inductor charges from the input and discharges into the capacitor. The ripple on the output capacitor becomes larger than expected compared to continuous mode calculation because of the current spikes from the input.

Boost (Step-up) Operation

The second mode is the conventional boost (step-up) mode of operation. The input current is a smooth waveform with a triangular ripple current. The output waveform exhibits ripple caused by the charging and discharging of the output capacitor and the current flowing through the capacitor's equivalent series resistance (ESR).

The third mode is the PFM mode. If the output voltage exceeds an upper limit, for whatever reason, the regulator enters the PFM mode. The regulator shuts down for one or more cycles until the output voltage drops below a pre-set threshold and one cycle is initiated. The inductor current falls to zero during the off time. The basic cycle is the 3.3mS PWM cycle but one or more cycles are dropped from the pulse train (also called pulse skipping). This may be in response to a light load condition or from a fast transient load condition where the output capacitor charges too high during load turn-off. In light load conditions, PFM mode offers high efficiency due to significantly lower quiescent current for the regulator. The output voltage will be a few tens of millivolts higher in the PFM mode than in the PWM mode.

The fourth mode of operation is the buck (step-down) mode and is described below.

Buck (Step-down) Operation

The “buck” mode is not a true switching regulator mode but allows the regulator to operate when the input voltage exceeds the output voltage. Once the input voltage exceeds the output voltage, the regulator is not capable of limiting the current in a non-dissipative fashion.

At the start of one of the buck mode cycles, current starts to flow in the inductor. If the input voltage is greater than the output voltage, a normal PWM cycle will not stop the current build up in the inductor. Current continues to build up in the inductor and flows into the capacitor causing the capacitor voltage to build up as t^2 . At some point the PFM limit will be exceeded and the regulator will stop the normal PWM cycle and turn off. The energy stored in the inductor, $1/2 \cdot L I^2$, will be dissipated in the pass transistor. The current in the inductor will drop to zero and the “buck” cycle will start all over again.

This mode of operation has similar efficiency as a linear regulator. The power dissipation and efficiency of the regulator is similar to a low dropout linear regulator :

$$\text{Power dissipation, } P_d = I_{OUT} (V_{IN} - V_{OUT})$$

$$\text{Efficiency, } \eta = V_{OUT}/V_{IN}$$

The advantage of this circuit is that there is no mode switching required by the user, it is automatic in the operation of the circuit. For example, in the limit where V_{IN} and V_{OUT} are approximately equal, a mixture of PFM and PWM cycles will occur to maintain the output voltage in regulation. **For the ILC6360 the buck mode of operation is limited to an input voltage 80mV higher than the output voltage or less.**

The output ripple will increase because of the larger current ripple associated with this mode of operation. The peak inductor current, I_{peak} , is about double the average output current. A large output capacitor with low ESR will decrease the output ripple voltage. A smaller inductor will reduce the time needed to charge up the inductor to maximum current. As a result, the output voltage ripple will decrease. A first order approximate equation for output ripple is as shown below :

$$V_{ripple} = (K \cdot L \cdot I_{OUT}^2) / C_{OUT}$$

where, L is the inductor value, C_{OUT} is the output capacitor value, I_{OUT} is the regulator output current and $K = 2.2$.

PWM Mode Operation

The ILC6360 uses a PWM or Pulse Width Modulation technique. The switches are constantly driven at typically 300kHz. The control circuitry varies the power being delivered to the load by varying the on-time, or duty cycle, of the switch SW1 (see fig. 2). Since more on-time translates to higher current build-up in the inductor, the maximum duty cycle of the switch determines the maximum load current that the device can support.

There are two key advantages of the PWM type controllers. First, because the controller automatically varies the duty cycle of the switch’s on-time in response to changing load conditions, the PWM controller will always have an optimized waveform for a steady-state load. This translates to very good efficiency at high currents and minimal ripple on the output. Ripple is caused by the constant charging and discharging of the output capacitor.

The other key advantage of the PWM type controllers is that the radiated noise due to the switching transients will always occur at the (fixed) switching frequency harmonics. Many applications do not care much about switching noise, but certain types of applications, especially communication equipment, need to minimize the high frequency interference within their system as much as possible. Using a boost converter will cause higher frequency noise to be generated; using a PWM converter makes that noise highly predictable; thus easier to filter out.

There are downsides of PWM approaches, especially at very low currents. Because the PWM technique relies on constant switching and varying duty cycle to match the load conditions, there is some point where the load current gets too small to be handled efficiently. An actual switch consumes some finite amount of current to switch on and off; at very low currents this can be of the same magnitude as the load current itself, driving switching efficiencies down to 50% and below.

PFM Mode Operation

The ILC6360 overcomes this limitation by automatically switching over to a PFM, or Pulse Frequency Modulation, technique at low currents. This technique conserves power loss by only switching the output if the current drain requires it. As shown in figure 3, the waveform actually skips pulses depending on the power needed by the output. This technique is also called “pulse skipping” because of this characteristic.

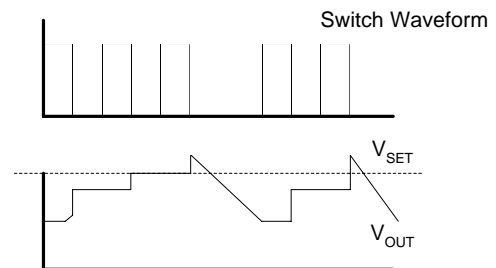

Fig 3: PFM Waveform

In the ILC6360, the switchover from PWM to PFM mode occurs when the PWM waveform drops to a low duty cycle. The low PWM duty cycle indicates to the controller that the load current is small and so it switches over to the PFM mode to improve efficiency and conserve power.

The Dual PWM/PFM mode architecture was designed specifically for applications such as wireless communications, which need the spectral predictability of a PWM-type DC-DC converter, yet also need the highest efficiencies possible, especially in standby mode.

Other Considerations

The other limitation of the PWM techniques is that, while the fundamental switching frequency is easier to filter out since it's constant, the higher order harmonics of PWM will be present and may have to be filtered out as well. Any filtering requirements, though, will vary by application and by actual system design and layout, so generalizations in this area are difficult, at best.

However, PWM control for boost DC-DC conversion is widely used, especially in audio-noise sensitive applications or applications requiring strict filtering of the high frequency components.

External Frequency Synchronization

External frequency synchronization is allowed on the ILC6360. When an external signal between 150kHz to 500kHz is connected to pin 4, the internal oscillator will be over-ridden. This technique is useful when designers wish to synchronize two or more converters using the same external source in order to avoid unexpected harmonics. **Connect pin 4 to ground or V_{IN} if the external frequency synchronization function is not used.**

Low Battery Detector

The ILC6360's low battery detector is based on a CMOS comparator. The negative input of the comparator is tied to an internal 1.25V (nominal) reference, V_{REF} . The positive input is the LBI/ \overline{SD} pin. It uses a simple potential divider arrangement with two resistors to set the LBI threshold as shown in figure 4. The input bias current of the LBI pin is only 200nA. This means that the resistor values R1 and R2 can be set quite high. The formula for setting the LBI threshold is:

$$V_{LBI} = V_{REF} \times (1 + R5/R6)$$

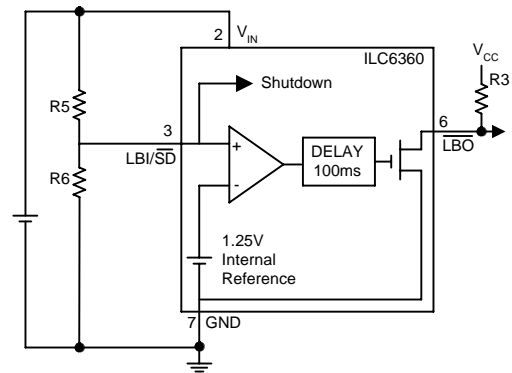

Fig 4: Low Battery Detector

Since the LBI input current is negligible ($<200nA$), this equation is derived by applying a voltage divider formula across R6. A typical value for R6 is 100k Ω .

$$R5 = 100k\Omega \times [(V_{LBI}/V_{REF}) - 1], \text{ where } V_{REF}=1.25V \text{ (nom.)}$$

The LBI detector has a built in delay of 120ms. In order to obtain a valid low-battery-output (LBO) signal, the input voltage must be lower than the low-battery-input (LBI) threshold for a duration greater than the low battery hold time ($t_{hold(LBI)}$) of 120msec. This feature eliminates false triggering due to voltage transients at the battery terminal caused by high frequency switching currents.

The output of the low battery detector is an open drain capable of sinking 2mA. A 10k Ω pull-up resistor is recommended on this output. **Note that when the device is not in PWM mode or is in shutdown the low battery detector does not operate.**

Shut Down

The LBI pin is shared with the shutdown pin. A low voltage ($<0.4V$) will put the ILC6360 into a power down state. The simplest way to implement this is with an FET across R6 as shown in figure 5.

When the ILC6360 is shut down, the synchronous rectifier disconnects the output from the input. This ensures that there is only leakage ($I_{SD} \leq 1\mu A$ typical) from the input to the output so that the battery is not drained when the ILC6360 is shut down.

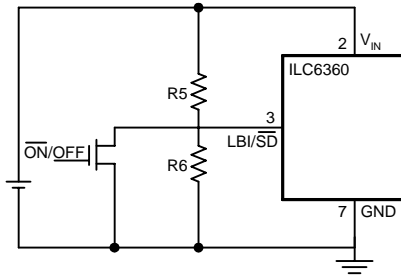

Fig 5: Shut Down Control

Power Good Output (\overline{POK})

The power good output of the ILC6360 indicates when V_{OUT} is within the regulation tolerance of the set output voltage. \overline{POK} output is an open drain device capable of sinking 2mA. It will remain pulled low until the output voltage has risen to typically 95% of the specified V_{OUT} .

Adjustable Output Voltage Selection

The ILC6360-ADJ allows the output voltage to be set using a potential divider. The formula for setting the adjustable output voltage is:

$$V_{OUT} = V_{FB} \times (1 + R1/R2)$$

Where V_{FB} is the feedback voltage which is 1.25V nominal.

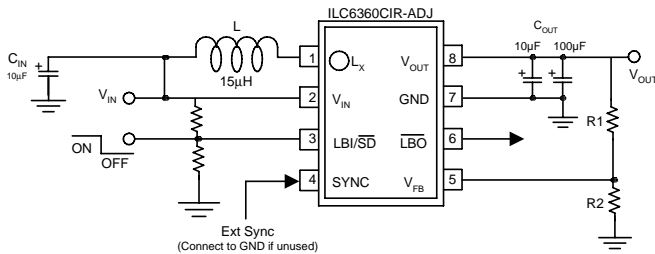

Adjustable Voltage Configuration

EXTERNAL COMPONENT SELECTION

Inductors

The ILC6360 is designed to work with a 15µH inductor in most applications. There are several vendors who supply standard surface mount inductors for this value. Suggested inductor manufacturers are shown in table 1. Higher values of inductance will improve efficiency, but will reduce peak inductor current and consequently ripple and noise, but will also limit output current.

Table 1

Vendor	Part No.	Contact
Coilcraft	DO330P-153	(847) 639-6400
	D03316P-153	www.coilcraft.com
	D01608C-153	
muRata	LQH4N150K	(814) 237-1431
	LQH3C150K	www.murata.com
Sumida	CDR74B-150MC	(847) 956-0666
	CD43-150	www.japanlink.com/sumida
	CD54-150	
TDK	NLC453232T-150K	(847) 390-4373 www.tdk.co.jp

Capacitors

Input Capacitor

The input capacitor is necessary to minimize the peak current drawn from the battery. Typically a 100µF tantalum capacitor is recommended. Low equivalent series resistance (ESR) capacitors will help to minimize battery voltage ripple.

Output Capacitor

Low ESR capacitors should be used at the output of the ILC6360 to minimize output ripple. The high switching speeds and fast changes in the output capacitor current, mean that the equivalent series resistance of the capacitor can contribute greatly to the output ripple. In order to minimize these effects choose an output capacitor with less than 10nH of equivalent series inductance (ESL) and less than 100mΩ of equivalent series resistance (ESR). Typically these characteristics are met with ceramic capacitors, but may also be met with certain types of tantalum capacitors. Suitable capacitor manufacturers are shown in table 2. A parallel combination of 10µF and 100µF is recommended at the output

Table 2

Description	Vendor	Contact
T495 series tantalum	Kemet	(864) 963-6300
595D series tantalum	Sprague	(603) 224-1961
TAJ, TPS series tantalum	AVX	(803) 946-0690
X7R Ceramic	TDK	(847) 390-4373
	AVX	(803) 946-0690
	Taiyo Yuden	(408) 573-4150

Layout And Grounding Considerations

High frequency switching and large peak currents means PCB design for DC-DC converters requires careful consideration. A general rule is to place the DC-DC converter circuitry well away from any sensitive RF or analog components. The layout of the DC-DC converters and its external components are also based on some simple rules to minimize EMI and output voltage ripple.

Layout

1. Place all power components, ILC6360, inductor, input capacitor and output capacitor as close together as possible.
2. Keep the output capacitor as close to the ILC6360 as possible with very short traces to the V_{OUT} and GND pins. Typically it should be within 0.25 inches or 6mm.

3. Keep the traces for the power components wide, typically > 50mil or 1.25mm.
4. Place the external networks for LBI and V_{FB} close to the ILC6360, but away from the power components as far as possible.

Grounding

1. Use a star grounding system with separate traces for the power ground and the low power signals such as LBI/ \overline{SD} and V_{FB} . The star should radiate from where the power supply enters the PCB.
2. On multilayer boards use component side copper for grounding around the ILC6360 and connect back to a quiet ground plane using vias.

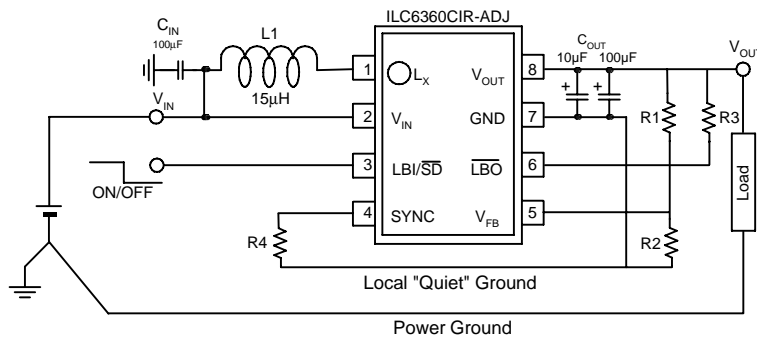

Step-Up/Step-Down DC-DC Converter for 1-Cell Lithium-Ion Batteries

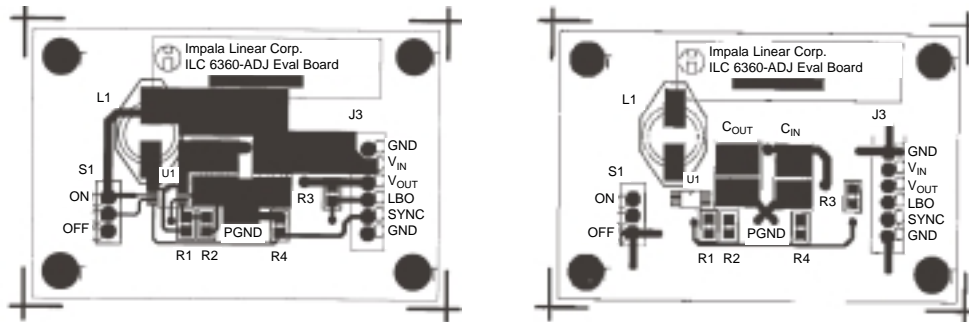

Evaluation Board Parts List For Printed Circuit Board Shown Above

Label	Part Number	Manufacturer	Description
U1	ILC6360CIR-ADJ	Impala Linear	Step-up/Step-down DC-DC converter
C _{IN} , C _{OUT1}	T495D107K010AS	Kemet	100 μ F, low ESR tantalum capacitor
C _{OUT2}	2221Y106M250NT	Novacap	10 μ F, ceramic capacitor
L1	DO1608C-153 CDR74B-150MC	Coilcraft Sumida	15 μ H, 0.15 Ω inductor 15 μ H, 0.08 Ω inductor
R1	-	Dale, Panasonic	768 Ω , 1/10W, 1% SMT
R2	-	Dale, Panasonic	374 Ω , 1/10W, 1% SMT
R3, R4	-	Dale, Panasonic	1Meg Ω , 1/10W, 5% SMT

Typical Performance Characteristics ILC6360CIR-36

Unless otherwise specified: $T_A = 25^\circ\text{C}$, $C_{IN} = 100\mu\text{F}$, $C_{OUT} = 10\mu\text{F} \parallel 100\mu\text{F}$, $L = 15\mu\text{H}$, $V_{OUT} = 3.6\text{V}$ (nominal)

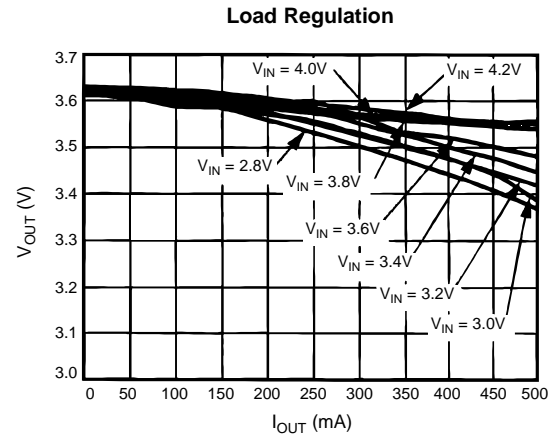
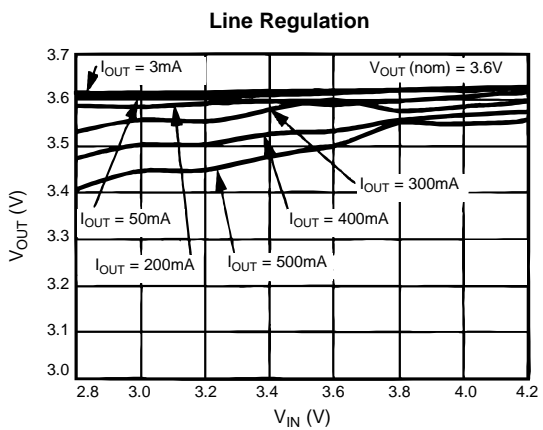
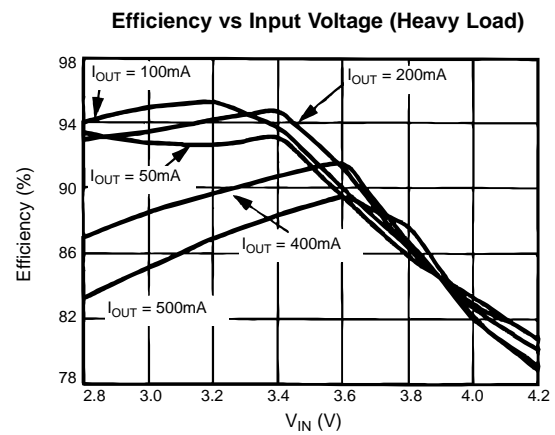
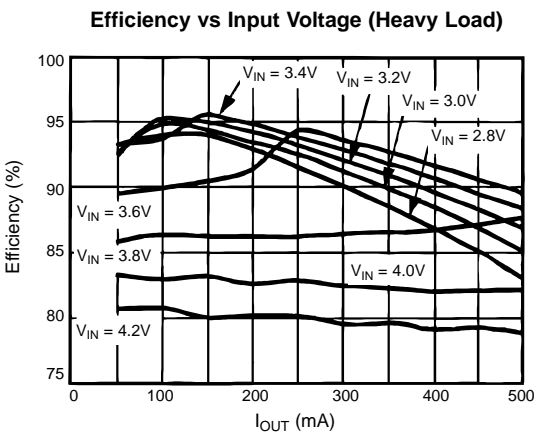
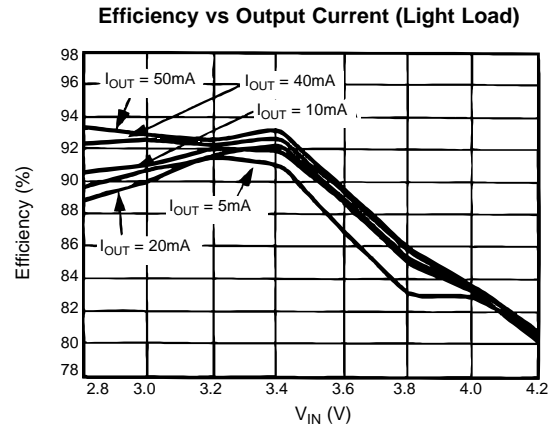
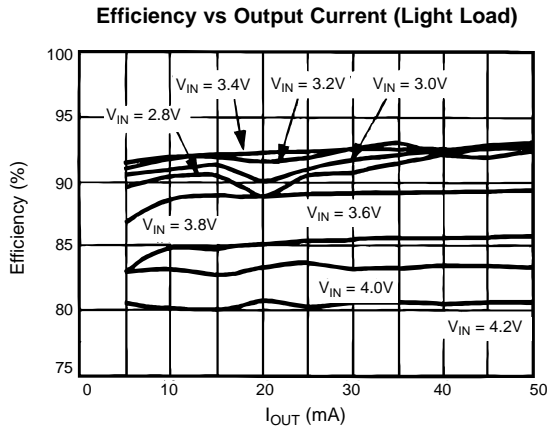

Typical Performance Characteristics ILC6360CIR-36

Unless otherwise specified: $T_A = 25^\circ\text{C}$, $C_{IN} = 100\mu\text{F}$, $C_{OUT} = 10\mu\text{F} \parallel 100\mu\text{F}$, $L = 15\mu\text{H}$, $V_{OUT} = 3.6\text{V}$ (nominal)

Output Ripple Voltage vs Input Voltage

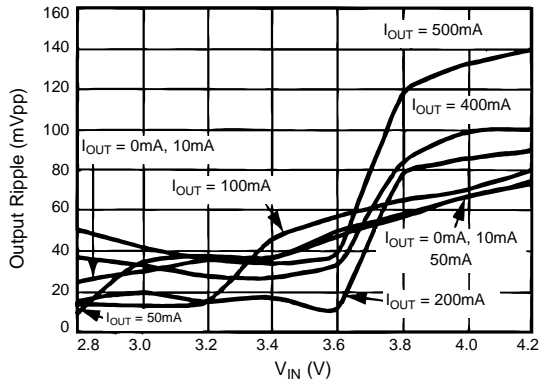

Ripple Current vs Input Voltage

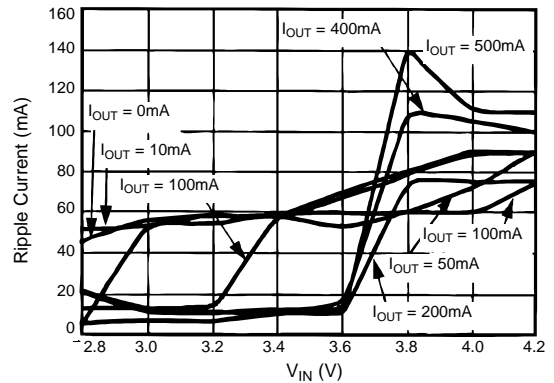

V_{IN} vs V_{OUT}

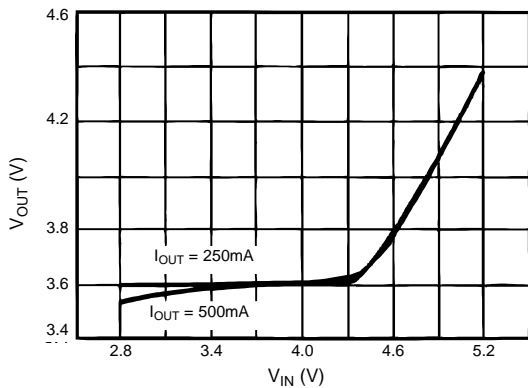

Line Transient Response

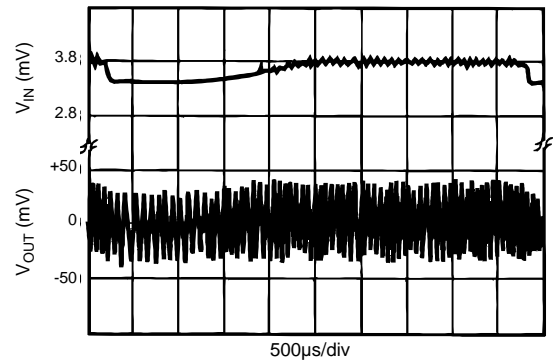

PWM Mode Load Switching Waveform

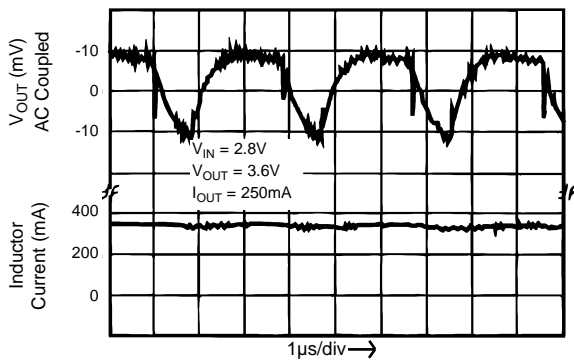

PFM Mode Load Switching Waveform

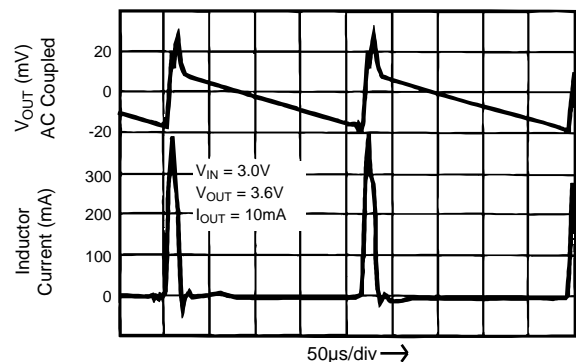

Typical Performance Characteristics ILC6360CIR-36

Unless otherwise specified: $T_A = 25^\circ\text{C}$, $C_{IN} = 100\mu\text{F}$, $C_{OUT} = 10\mu\text{F} \parallel 100\mu\text{F}$, $L = 15\mu\text{H}$, $V_{OUT} = 3.6\text{V}$ (nominal)

V_{OUT} vs Temperature

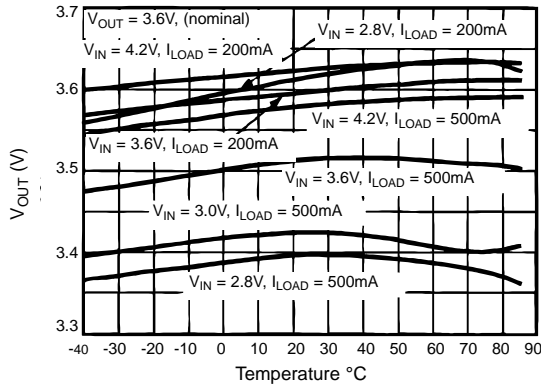

Low Battery Output ($V_{IN} < V_{TH}$ for Greater than 100ms)
10k Ω pull-up resistor from LBO to 3V supply

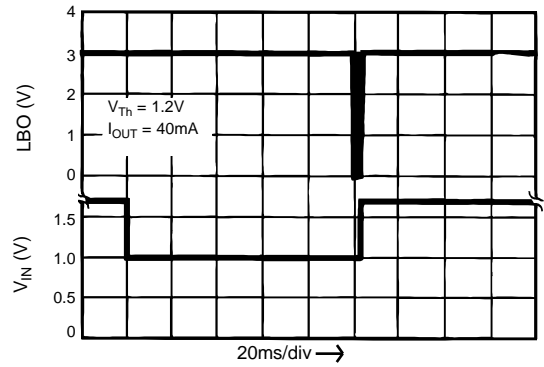

Low Battery Output ($V_{IN} < V_{TH}$ for Less than 100ms)
10k Ω pull-up resistor from LBO to 3V supply

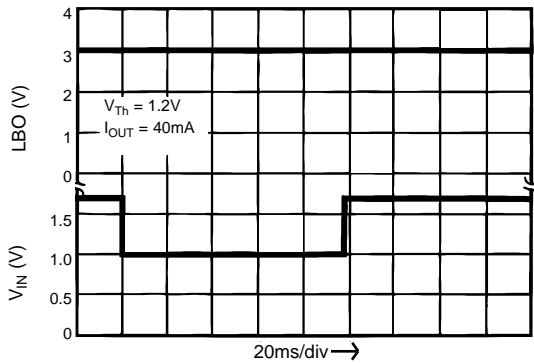

Spectral Noise Plot

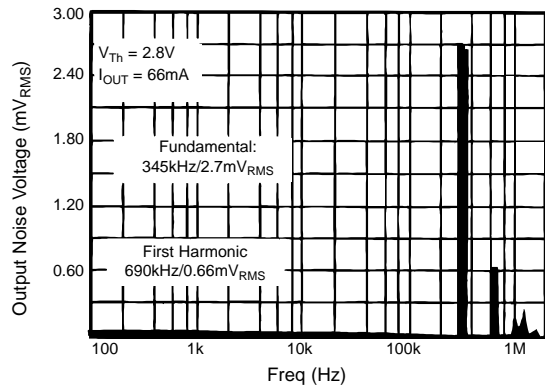

Spectral Noise Plot

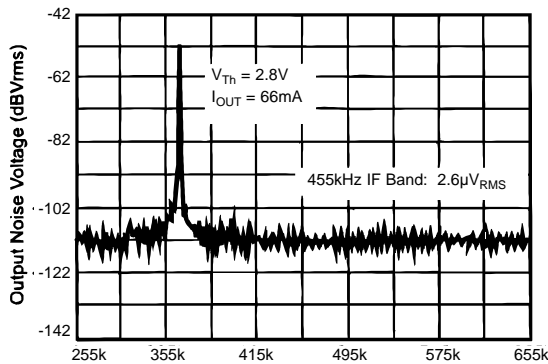

Package Dimensions

MSOP-8

All dimensions in inches (mm)

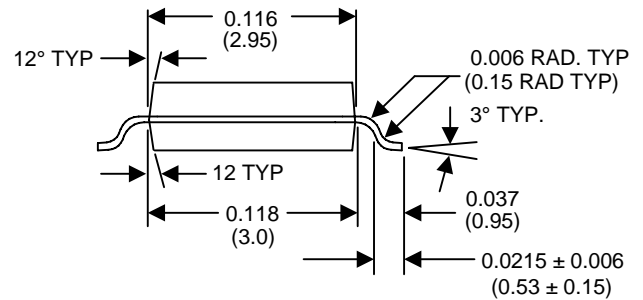
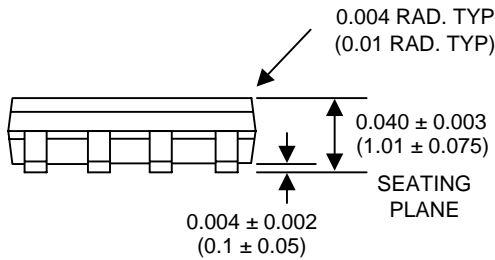
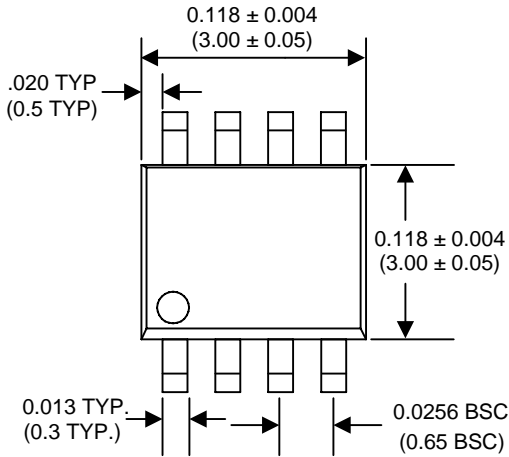

Devices sold by Impala Linear Corporation are covered by the warranty and patent indemnification provisions appearing in its Terms of Sale only. Impala Linear Corporation makes no warranty, express, statutory, implied, or by description regarding the information set forth herein or regarding the freedom of the described devices from patent infringement. Impala Linear Corporation makes no warranty of merchantability or fitness for any purpose. Impala Linear Corporation reserves the right to discontinue production and change specifications and prices at any time and without notice.

This product is intended for use in normal commercial applications. Applications requiring an extended temperature range, unusual environmental requirements, or high reliability applications, such as military and aerospace, are specifically not recommended without additional processing by Impala Linear Corporation.

Impala Linear Corporation assumes no responsibility for the use of any circuitry other than circuitry embodied in an Impala Linear Corporation product. No other circuits, patents, licenses are implied.

Life Support Policy

Impala Linear Corporation's products are not authorized for use as critical components in life support devices or systems.

1. Life support devices or systems are devices or systems which, (a) are intended for surgical implant into the body, or (b) support or sustain life, and whose failure to perform, when properly used in accordance with instructions for use provided in the labeling, can be reasonably expected to result in a significant injury to the user.

2. A critical component is any component of a life support device or system whose failure to perform can be reasonably expected to cause the failure of the life support device or system, or to affect its safety or effectiveness.