

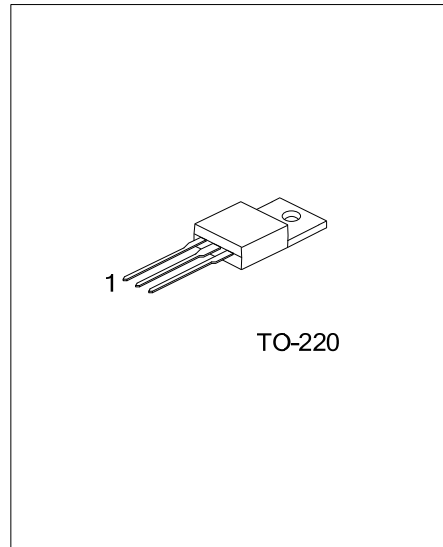

MJE13007D

NPN SILICON TRANSISTOR

NPN BIPOLAR POWER TRANSISTOR FOR SWITCHING POWER SUPPLY APPLICATIONS



DESCRIPTION

The UTC **MJE13007D** is designed for high-voltage, high-speed power switching inductive circuits where fall time is critical. It is particularly suited for 115 and 220 V switch mode applications.

FEATURES

* $V_{CEO(SUS)}$ 400V

* 700V Blocking Capability

ORDERING INFORMATION

Ordering Number		Package	Pin Assignment			Packing
Lead Free	Halogen Free		1	2	3	
MJE13007DL-TA3-T	MJE13007DG-TA3-T	TO-220	B	C	E	Tube

<p>MJE13007DL-TA3-T</p> <p>(1) Packing Type (2) Package Type (3) Lead Free</p>	<p>(1) T: Tube (2) TA3: TO-220 (3) G: Halogen Free, L: Lead Free</p>
--	--

■ ABSOLUTE MAXIMUM RATING

PARAMETER		SYMBOL	RATINGS	UNIT
Collector-Emitter Sustaining Voltage		V_{CEO}	400	V
Collector-Emitter Breakdown Voltage		V_{CBO}	700	V
Emitter-Base Voltage		V_{EBO}	9.0	V
Collector Current	Continuous	I_C	8.0	A
	Peak (1)	I_{CM}	16	A
Base Current	Continuous	I_B	4.0	A
	Peak (1)	I_{BM}	8.0	A
Emitter Current	Continuous	I_E	12	A
	Peak (1)	I_{EM}	24	A
Power Dissipation	$T_C = 25^\circ\text{C}$	P_D	80	W
Junction Temperature		T_J	+150	$^\circ\text{C}$
Storage Temperature		T_{STG}	-55~+150	$^\circ\text{C}$

Note: Absolute maximum ratings are those values beyond which the device could be permanently damaged. Absolute maximum ratings are stress ratings only and functional device operation is not implied.

■ THERMAL DATA

PARAMETER	SYMBOL	RATINGS	UNIT
Junction to Ambient	θ_{JA}	62.5	$^\circ\text{C}/\text{W}$
Junction to Case	θ_{JC}	1.56	$^\circ\text{C}/\text{W}$

Note 1: Pulse Test: Pulse Width = 5.0 ms, Duty Cycle $\leq 10\%$.

Measurement made with thermocouple contacting the bottom insulated mounting surface of the package (in a location beneath the die), the device mounted on a heatsink with thermal grease applied at a mounting torque of 6 to 8•lbs.

■ ELECTRICAL CHARACTERISTICS ($T_C=25^\circ\text{C}$, unless otherwise noted)

PARAMETER	SYMBOL	TEST CONDITIONS	MIN	TYP	MAX	UNIT
Collector-Emitter Sustaining Voltage	$V_{CEO(SUS)}$	$I_C=10\text{mA}, I_B=0$	400			V
Collector Cutoff Current	I_{CBO}	$V_{CES}=700\text{V}$			0.1	mA
		$V_{CES}=700\text{V}, T_C=125^\circ\text{C}$			1.0	mA
Emitter Cutoff Current	I_{EBO}	$V_{EB}=9.0\text{V}, I_C=0$			100	μA
DC Current Gain	h_{FE1}	$I_C=2.0\text{A}, V_{CE}=5.0\text{V}$	8.0		40	
	h_{FE2}	$I_C=5.0\text{A}, V_{CE}=5.0\text{V}$	5.0		30	
Collector-Emitter Saturation Voltage	$V_{CE(SAT)}$	$I_C=2.0\text{A}, I_B=0.4\text{A}$			1.0	V
		$I_C=5.0\text{A}, I_B=1.0\text{A}$			2.0	V
		$I_C=8.0\text{A}, I_B=2.0\text{A}$			3.0	V
		$I_C=5.0\text{A}, I_B=1.0\text{A}, T_C=100^\circ\text{C}$			3.0	V
Base-Emitter Saturation Voltage	$V_{BE(SAT)}$	$I_C=2.0\text{A}, I_B=0.4\text{A}$			1.2	V
		$I_C=5.0\text{A}, I_B=1.0\text{A}$			1.6	V
		$I_C=5.0\text{A}, I_B=1.0\text{A}, T_C=100^\circ\text{C}$			1.5	V
Current-Gain-Bandwidth Product	f_T	$I_C=500\text{mA}, V_{CE}=10\text{V}, f=1.0\text{MHz}$	4.0	14		MHz
Output Capacitance	C_{OB}	$V_{CB}=10\text{V}, I_E=0, f=0.1\text{MHz}$		80		pF

RESISTIVE LOAD (TABLE 1)

PARAMETER	SYMBOL	TEST CONDITIONS	MIN	TYP	MAX	UNIT
Delay Time	t_D	$V_{CC}=125\text{V}, I_C=5.0\text{A}, I_{B1}=I_{B2}=1.0\text{A}, t_p=25\mu\text{s}, \text{Duty Cycle} \leq 1.0\%$		0.025	0.1	μs
Rise Time	t_R			0.5	1.5	μs
Storage Time	t_S			1.8	3.0	μs
Fall Time	t_F			0.23	0.7	μs

Note: Pulse Test: Pulse Width $\leq 300\mu\text{s}$, Duty Cycle $\leq 2.0\%$

■ TYPICAL THERMAL RESPONSE

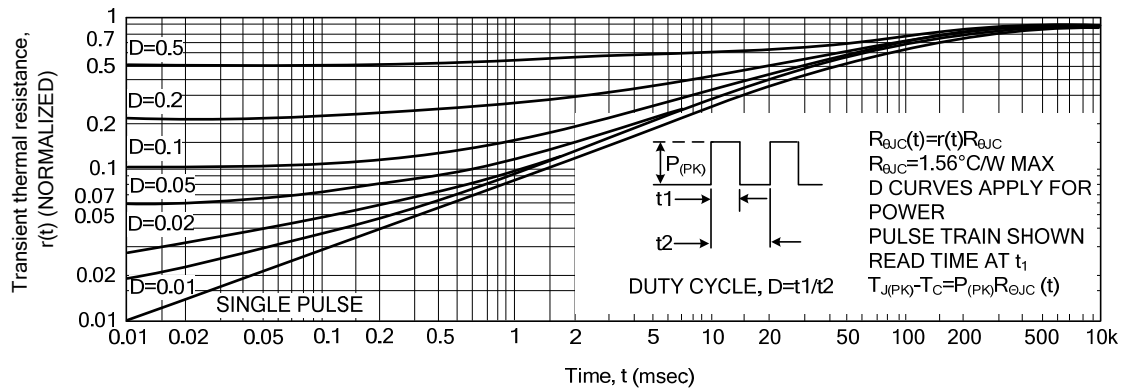

Fig. 1 Typical Thermal Response

There are two limitations on the power handling ability of a transistor: average junction temperature and second breakdown. Safe operating area curves indicate I_C - V_{CE} limits of the transistor that must be observed for reliable operation; i.e., the transistor must not be subjected to greater dissipation than the curves indicate.

The data of Fig. 7 is based on $T_C = 25^\circ\text{C}$; $T_{J(PK)}$ is variable depending on power level. Second breakdown pulse limits are valid for duty cycles to 10% but must be debated when $T_C \geq 25^\circ\text{C}$. Second breakdown limitations do not debate the same as thermal limitations. Allowable current at the voltages shown on Fig. 7 may be found at any case temperature by using the appropriate curve on Fig. 9.

At high case temperatures, thermal limitations will reduce the power that can be handled to values less than the limitations imposed by second breakdown.

Use of reverse biased safe operating area data (Fig. 8) is discussed in the applications information section.

■ TYPICAL THERMAL RESPONSE(Cont.)

Table 1. Test Conditions for Dynamic Performance

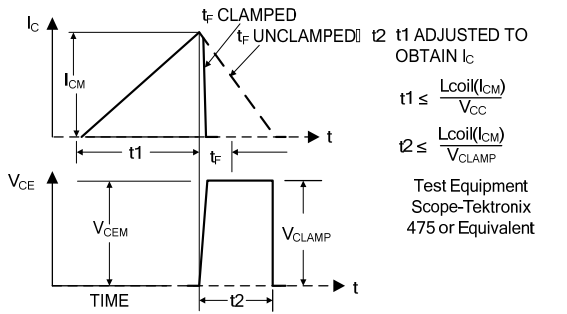
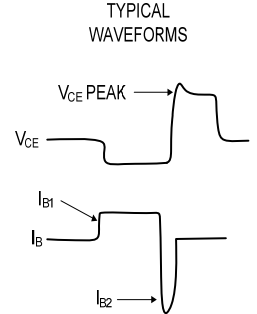
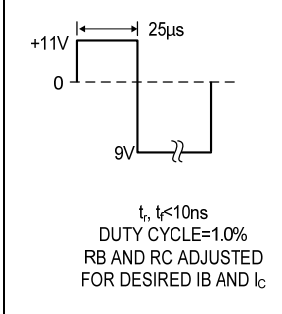
TEST CIRCUITS	REVERSE BIAS SAFE OPERATING AREA AND INDUCTIVE SWITCHING	RESISTIVE SWITCHING						
CIRCUIT VALUES	<table border="1"> <thead> <tr> <th>BV_{CEO(SUS)}</th> <th>Inductive Switching</th> <th>RBSOA</th> </tr> </thead> <tbody> <tr> <td>L=10mH R_{B2}=8 V_{CC}=20V I_{C(PK)}=100mA</td> <td>L=20mH R_{B2}=0 V_{CC}=15V R_{B1} selected for desired I_{B1}</td> <td>L=500mH R_{B2}=0 V_{CC}=15Volts R_{B1} selected for desired I_{B1}</td> </tr> </tbody> </table>	BV _{CEO(SUS)}	Inductive Switching	RBSOA	L=10mH R _{B2} =8 V _{CC} =20V I _{C(PK)} =100mA	L=20mH R _{B2} =0 V _{CC} =15V R _{B1} selected for desired I _{B1}	L=500mH R _{B2} =0 V _{CC} =15Volts R _{B1} selected for desired I _{B1}	<p>V_{CC}=125V R_C=25Ω D1=1N5820 OR EQUIV</p>
BV _{CEO(SUS)}	Inductive Switching	RBSOA						
L=10mH R _{B2} =8 V _{CC} =20V I _{C(PK)} =100mA	L=20mH R _{B2} =0 V _{CC} =15V R _{B1} selected for desired I _{B1}	L=500mH R _{B2} =0 V _{CC} =15Volts R _{B1} selected for desired I _{B1}						
 <p> $t_1 \leq \frac{L_{coil}(I_{CM})}{V_{CC}}$ $t_2 \leq \frac{L_{coil}(I_{CM})}{V_{CLAMP}}$ Test Equipment Scope-Tektronix 475 or Equivalent </p>	<p>TYPICAL WAVEFORMS</p> 	 <p> $t_r, t_f < 10ns$ DUTY CYCLE=1.0% RB AND RC ADJUSTED FOR DESIRED IB AND IC </p>						

TYPICAL CHARACTERISTICS

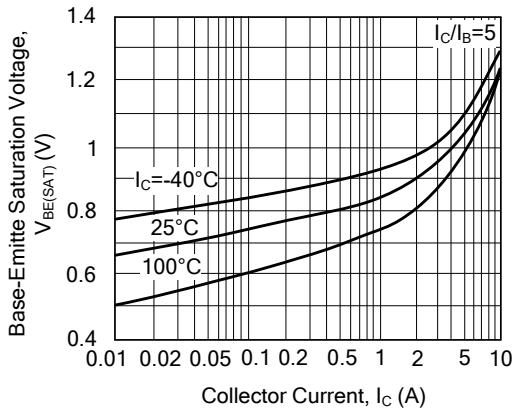

Fig. 2 Base-Emitter Saturation Voltage

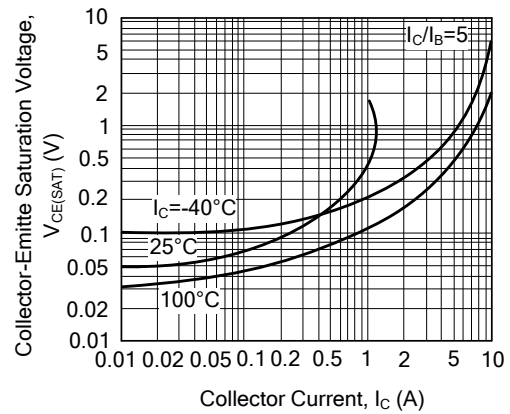

Fig. 3 Collector-Emitter Saturation Voltage

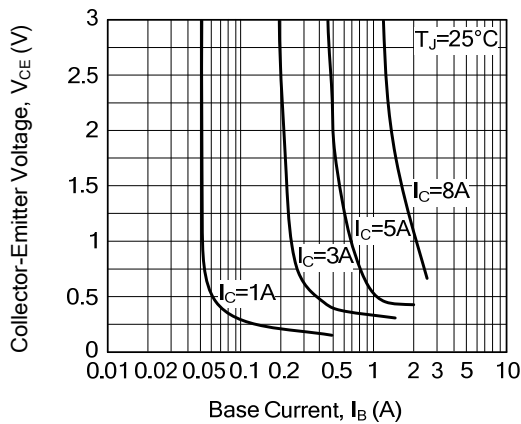

Fig. 4 Collector Saturation Region

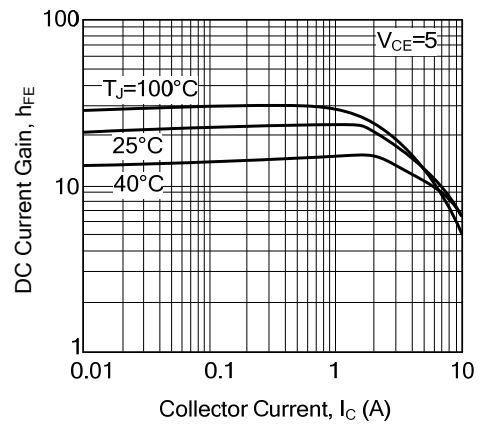

Fig. 5 DC Current Gain

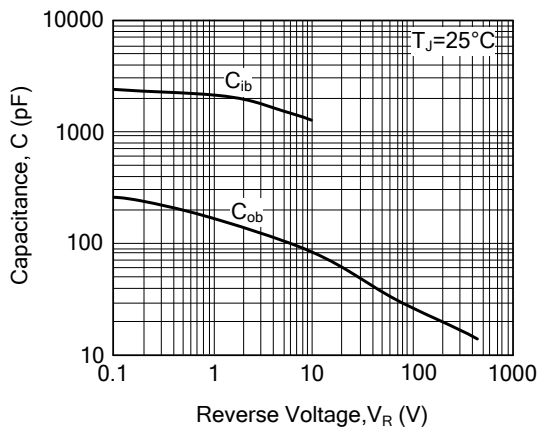

Fig. 6 Capacitance

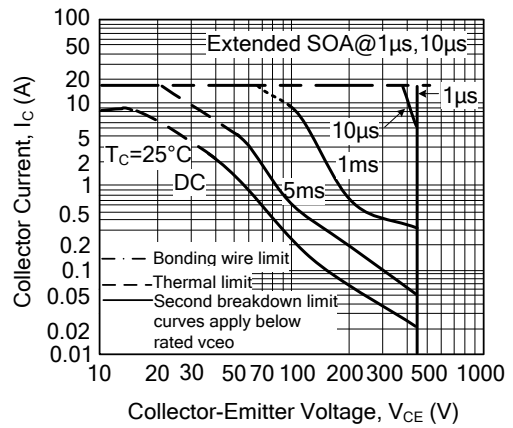

Fig. 7 Maximum Forward Bias Safe Operating Area

TYPICAL CHARACTERISTICS

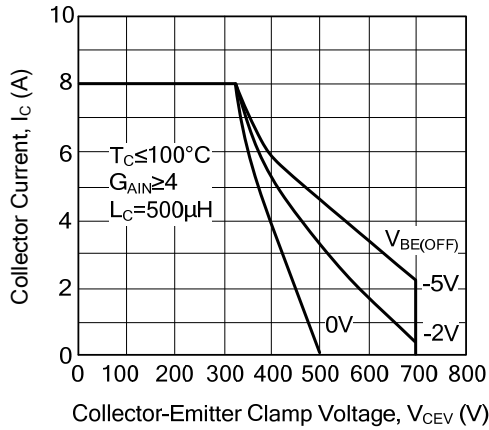

Fig. 8 Maximum Reverse Bias Switching Safe Operating Area

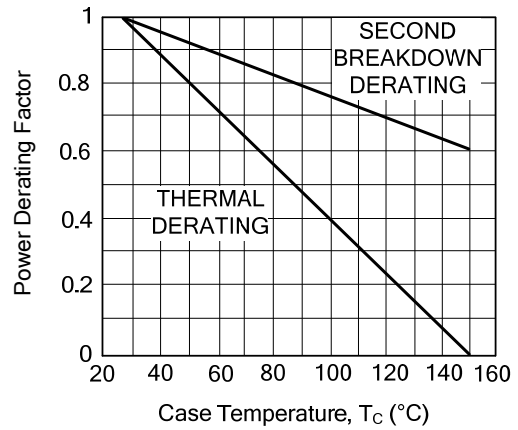

Fig. 9 Forward Bias Power Derating

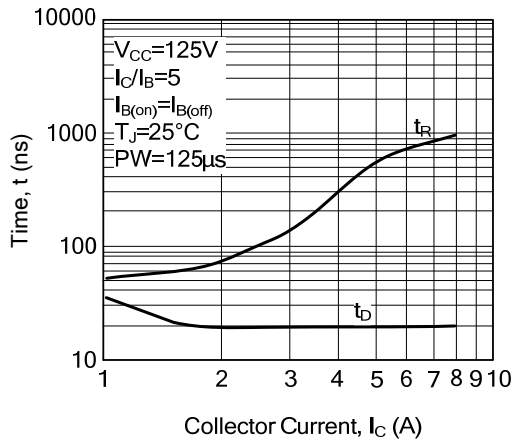

Fig. 10 Turn-On Time(Resistive Load)

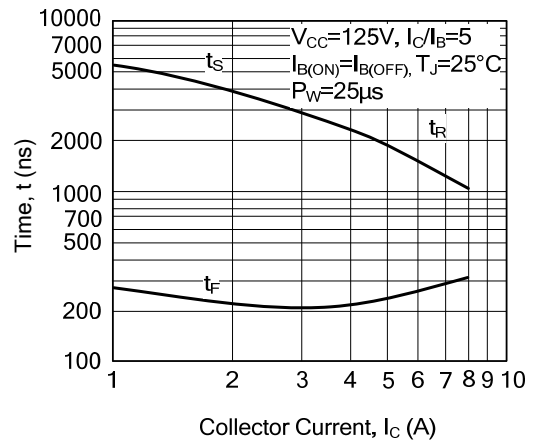

Fig. 11 Turn-Off Time(Resistive Load)

UTC assumes no responsibility for equipment failures that result from using products at values that exceed, even momentarily, rated values (such as maximum ratings, operating condition ranges, or other parameters) listed in products specifications of any and all UTC products described or contained herein. UTC products are not designed for use in life support appliances, devices or systems where malfunction of these products can be reasonably expected to result in personal injury. Reproduction in whole or in part is prohibited without the prior written consent of the copyright owner. The information presented in this document does not form part of any quotation or contract, is believed to be accurate and reliable and may be changed without notice.