

Low $V_{CE(sat)}$

2SA1567

Silicon PNP Epitaxial Planar Transistor (Complement to type 2SC4064)

Application : DC Motor Driver, Chopper Regulator and General Purpose

Absolute maximum ratings ($T_a=25^\circ\text{C}$)

Symbol	Rated	Unit
V_{CBO}	-50	V
V_{CEO}	-50	V
V_{EBO}	-6	V
I_C	-12	A
I_B	-3	A
P_C	35($T_c=25^\circ\text{C}$)	W
T_j	150	$^\circ\text{C}$
T_{stg}	-55 to +150	$^\circ\text{C}$

Electrical Characteristics ($T_a=25^\circ\text{C}$)

Symbol	Conditions	Rated	Unit
I_{CBO}	$V_{CB}=-50\text{V}$	-100max	μA
I_{EBO}	$V_{EB}=-6\text{V}$	-100max	μA
$V_{(BR)CEO}$	$I_C=-25\text{mA}$	-50min	V
h_{FE}	$V_{CE}=-1\text{V}, I_C=-6\text{A}$	50min	
$V_{CE(sat)}$	$I_C=-6\text{A}, I_B=-0.3\text{A}$	-0.35max	V
f_r	$V_{CE}=-12\text{V}, I_E=0.5\text{A}$	40typ	MHz
COB	$V_{CB}=-10\text{V}, f=1\text{MHz}$	330typ	pF

External Dimensions FM20 (TO220F)

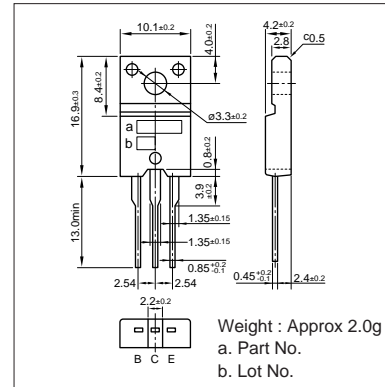

Typical Switching Characteristics (Common Emitter)

V_{CC} (V)	R_L (Ω)	I_C (A)	V_{BB1} (V)	V_{BB2} (V)	I_{B1} (mA)	I_{B2} (mA)	t_{on} (μs)	t_{stg} (μs)	t_f (μs)
-24	4	-6	-10	5	-120	120	0.4typ	0.4typ	0.2typ

I_C-V_{CE} Characteristics (Typical)

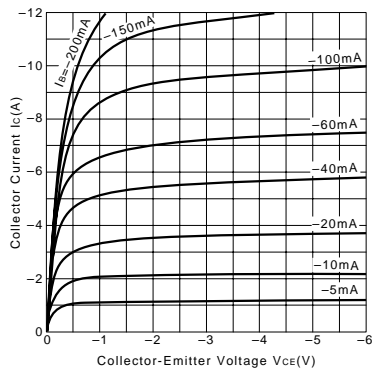

$V_{CE(sat)}-I_B$ Characteristics (Typical)

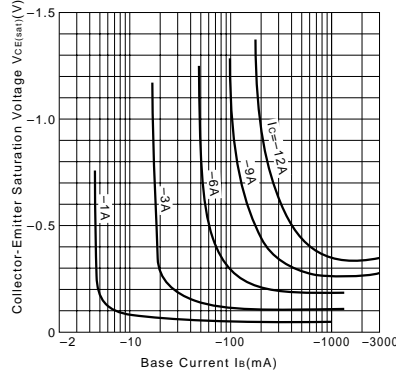

I_C-V_{BE} Temperature Characteristics (Typical)

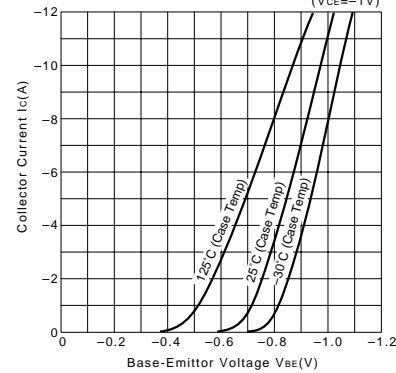

$h_{FE}-I_C$ Characteristics (Typical)

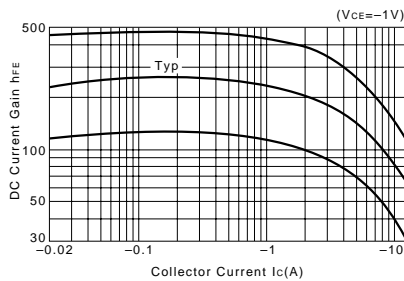

$h_{FE}-I_C$ Temperature Characteristics (Typical)

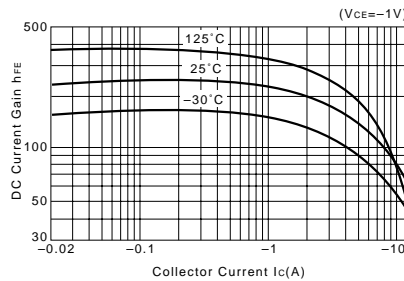

$\theta_{j-a}-t$ Characteristics

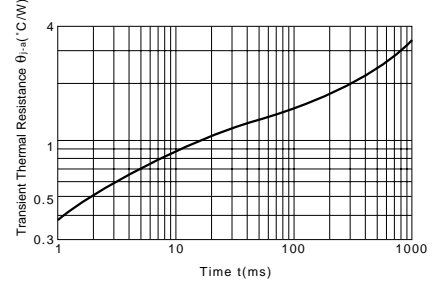

f_r-I_E Characteristics (Typical)

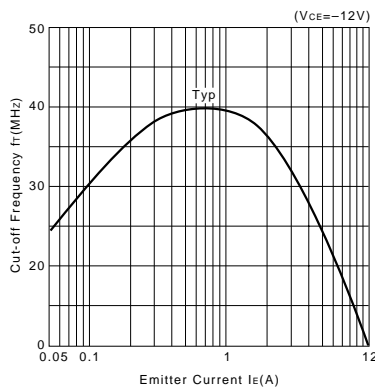

Safe Operating Area (Single Pulse)

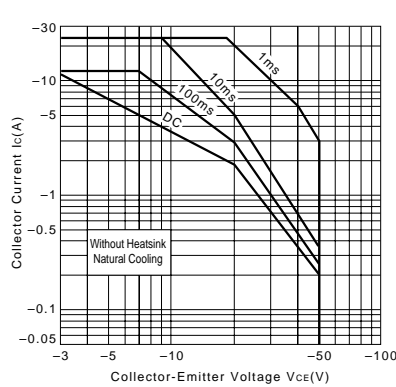

P_C-T_a Derating

