

Silicon PNP Epitaxial Planar Transistor (Complement to type 2SC3264)

Application : Audio and General

Absolute maximum ratings (Ta=25°C)

| Symbol | Ratings | Unit |
|------------------|---------------------------|------|
| V _{CB0} | -230 | V |
| V _{CE0} | -230 | V |
| V _{EBO} | -5 | V |
| I _C | -17 | A |
| I _B | -5 | A |
| P _C | 200(T _C =25°C) | W |
| T _J | 150 | °C |
| T _{stg} | -55 to +150 | °C |

Electrical Characteristics (Ta=25°C)

| Symbol | Conditions | Ratings | Unit |
|----------------------|--------------------------------------------|---------|------|
| I _{CB0} | V _{CB} =-230V | -100max | μA |
| I _{EBO} | V _{EB} =-5V | -100max | μA |
| V _{(BR)CEO} | I _C =-25mA | -230min | V |
| h _{FE} | V _{CE} =-4V, I _C =-5A | 50min* | |
| V _{CE(sat)} | I _C =-5A, I _B =-0.5A | -2.0max | V |
| f _T | V _{CE} =-12V, I _E =2A | 35typ | MHz |
| C _{OB} | V _{CB} =-10V, f=1MHz | 500typ | pF |

*h_{FE} Rank O(50 to 100), Y(70 to 140)

Typical Switching Characteristics (Common Emitter)

| V _{CC} (V) | R _L (Ω) | I _C (A) | V _{BB1} (V) | V _{BB2} (V) | I _{B1} (mA) | I _{B2} (mA) | t _{on} (μs) | t _{stg} (μs) | t _f (μs) |
|---------------------|--------------------|--------------------|----------------------|----------------------|----------------------|----------------------|----------------------|-----------------------|---------------------|
| -60 | 12 | -5 | -10 | 5 | -500 | 500 | 0.35typ | 1.50typ | 0.30typ |

External Dimensions MT-200

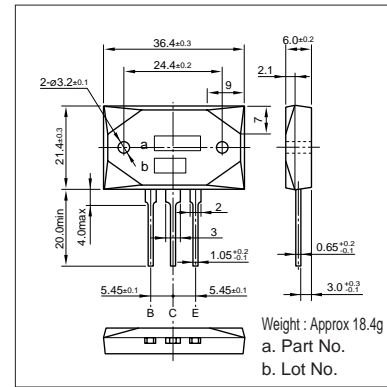

I_C-V_{CE} Characteristics (Typical)

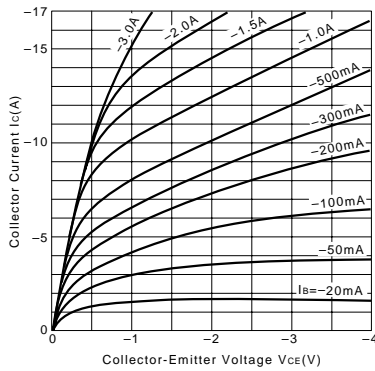

V_{CE(sat)}-I_B Characteristics (Typical)

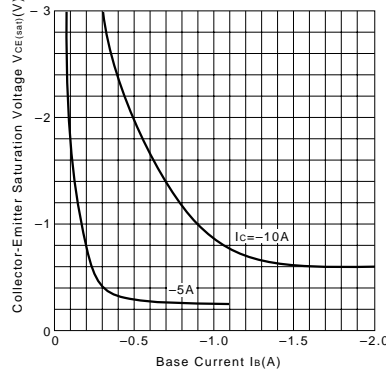

I_C-V_{BE} Temperature Characteristics (Typical)

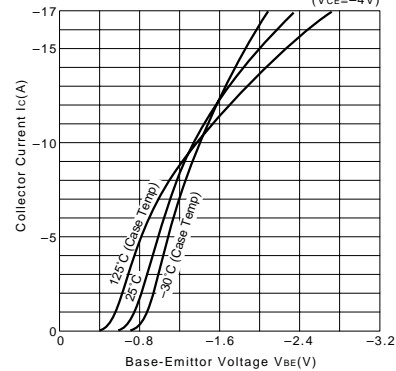

h_{FE}-I_C Characteristics (Typical)

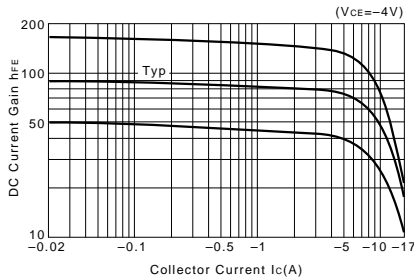

h_{FE}-I_C Temperature Characteristics (Typical)

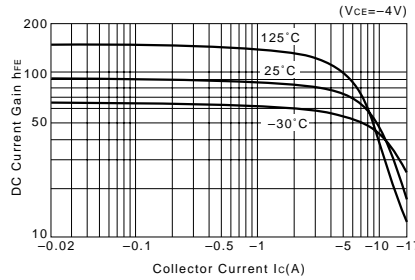

θ_{J-a}-t Characteristics

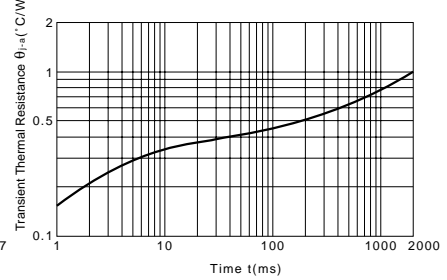

f_T-I_E Characteristics (Typical)

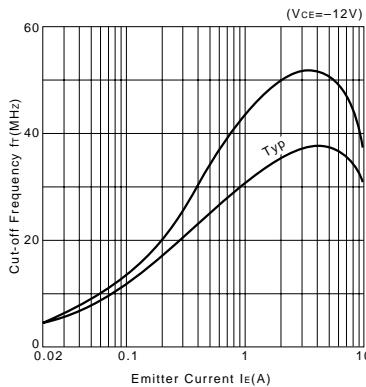

Safe Operating Area (Single Pulse)

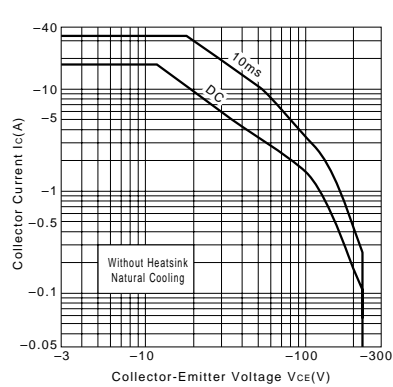

P_C-T_a Derating

