



SANYO Semiconductors DATA SHEET

2SC5538A — NPN Epitaxial Planar Silicon Transistor VHF to UHF Band OSC, High-Frequency Amplifier Applications

Features

- High gain : $|S_{21e}|^2=10.5\text{dB typ (f=1GHz)}$.
- High cut-off frequency : $f_T=5.2\text{GHz typ}$.
- Ultrasmall, slim flat-lead package (1.4mm×0.8mm×0.6mm).
- Halogen free compliance.

Specifications

Absolute Maximum Ratings at $T_a=25^\circ\text{C}$

Parameter	Symbol	Conditions	Ratings	Unit
Collector-to-Base Voltage	V _{CB0}		20	V
Collector-to-Emitter Voltage	V _{CEO}		10	V
Emitter-to-Base Voltage	V _{EBO}		2	V
Collector Current	I _C		100	mA
Collector Dissipation	P _C		100	mW
Junction Temperature	T _J		150	°C
Storage Temperature	T _{stg}		-55 to +150	°C

Electrical Characteristics at $T_a=25^\circ\text{C}$

Parameter	Symbol	Conditions	Ratings			Unit
			min	typ	max	
Collector Cutoff Current	I _{CBO}	V _{CB} =10V, I _E =0A			1.0	μA
Emitter Cutoff Current	I _{EBO}	V _{EB} =1V, I _C =0A			10	μA
DC Current Gain	h _{FE1}	V _{CE} =3V, I _C =7mA	110		200	
	h _{FE2}	V _{CE} =3V, I _C =30mA	100			
Gain-Bandwidth Product	f _T	V _{CE} =3V, I _C =7mA	3	5.2		GHz
Output Capacitance	C _{ob}	V _{CB} =3V, f=1MHz		1.0	1.5	pF
Reverse Transfer Capacitance	C _{re}	V _{CB} =3V, f=1MHz		0.7		pF

Marking : NA

Continued on next page.

- Any and all SANYO Semiconductor Co.,Ltd. products described or contained herein are, with regard to "standard application", intended for the use as general electronics equipment (home appliances, AV equipment, communication device, office equipment, industrial equipment etc.). The products mentioned herein shall not be intended for use for any "special application" (medical equipment whose purpose is to sustain life, aerospace instrument, nuclear control device, burning appliances, transportation machine, traffic signal system, safety equipment etc.) that shall require extremely high level of reliability and can directly threaten human lives in case of failure or malfunction of the product or may cause harm to human bodies, nor shall they grant any guarantee thereof. If you should intend to use our products for applications outside the standard applications of our customer who is considering such use and/or outside the scope of our intended standard applications, please consult with us prior to the intended use. If there is no consultation or inquiry before the intended use, our customer shall be solely responsible for the use.
- Specifications of any and all SANYO Semiconductor Co.,Ltd. products described or contained herein stipulate the performance, characteristics, and functions of the described products in the independent state, and are not guarantees of the performance, characteristics, and functions of the described products as mounted in the customer's products or equipment. To verify symptoms and states that cannot be evaluated in an independent device, the customer should always evaluate and test devices mounted in the customer's products or equipment.

2SC5538A

Continued from preceding page.

Parameter	Symbol	Conditions	Ratings			Unit
			min	typ	max	
Forward Transfer Gain	$ S_{21e} ^2$	$V_{CE}=3V, I_C=7mA, f=1GHz$	8	10.5		dB
Noise Figure	NF	$V_{CE}=3V, I_C=7mA, f=1GHz$		1.4	2.5	dB

Package Dimensions

unit : mm (typ)

7027-002

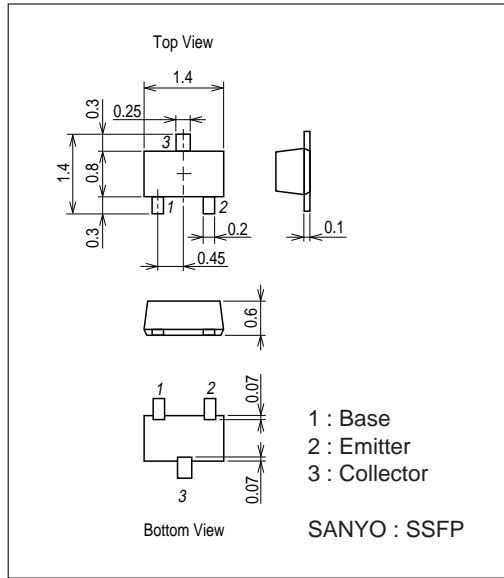

Marking

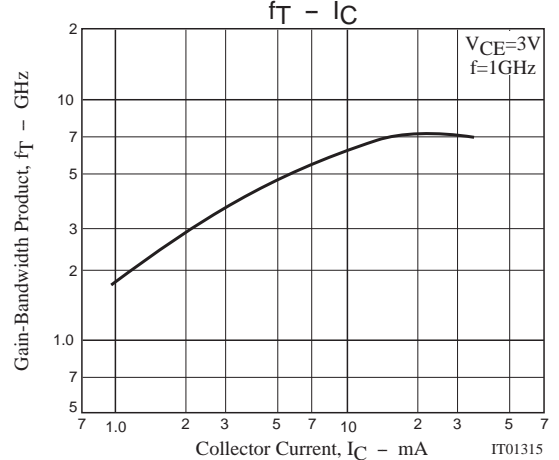
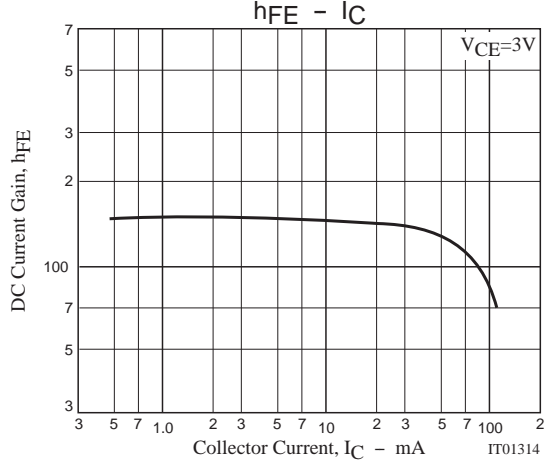
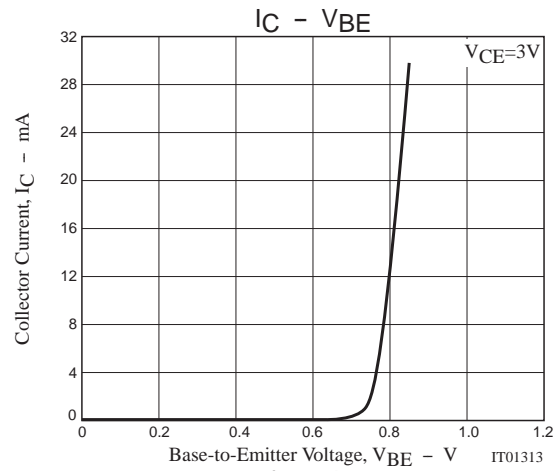
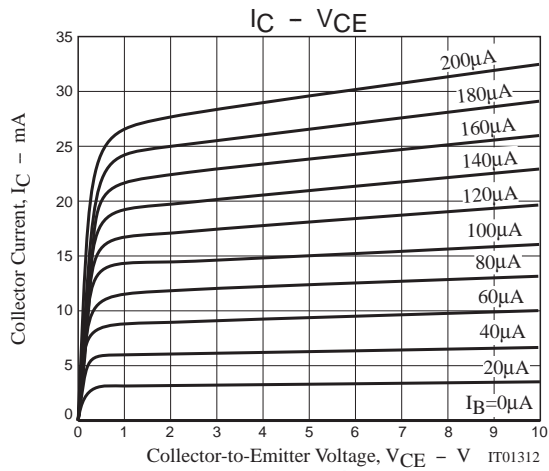
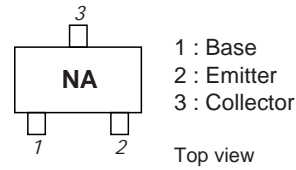

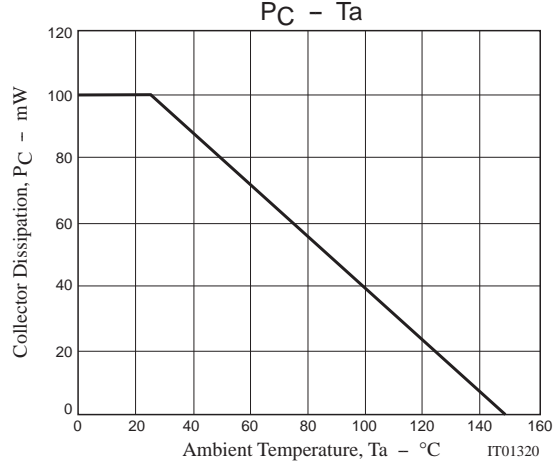
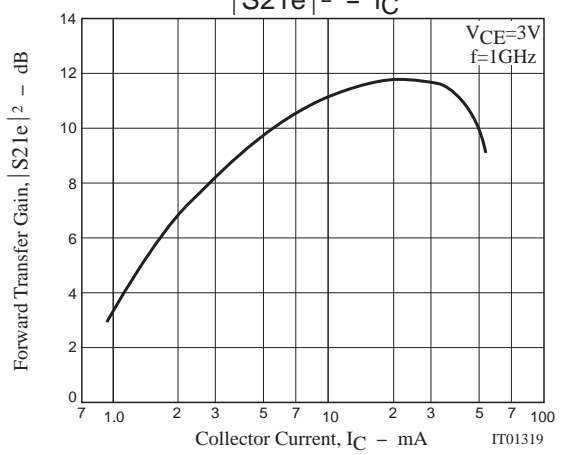
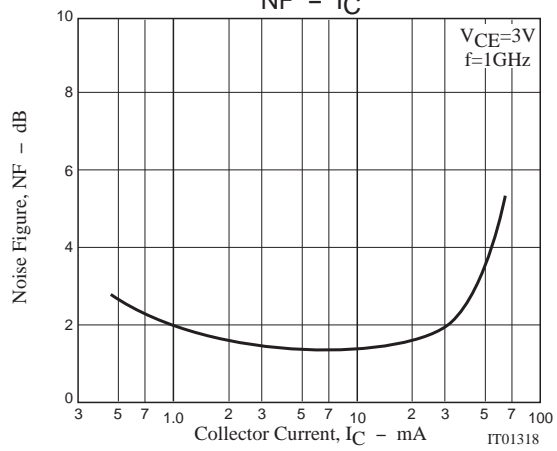
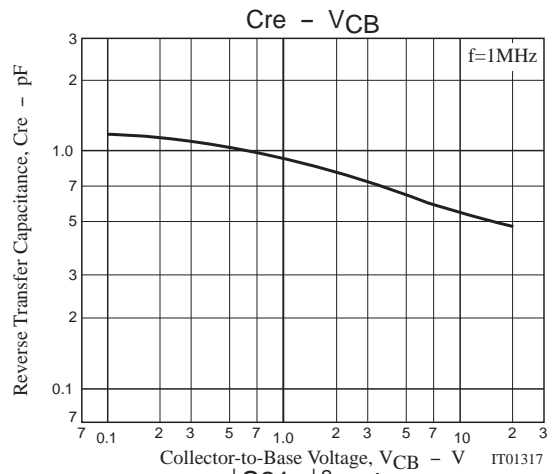
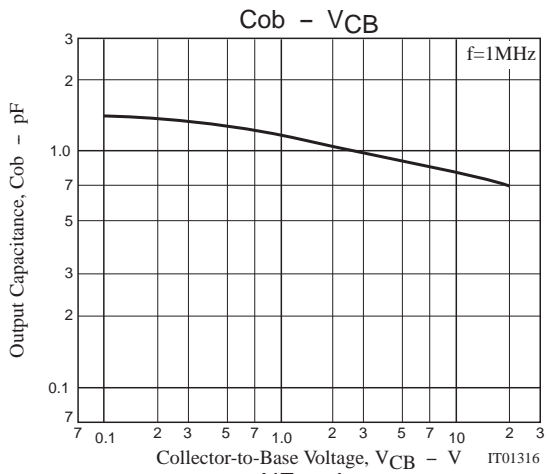

2SC5538A

S Parameters (Common emitter)

$V_{CE}=1V, I_C=3mA, Z_O=50\Omega$

Freq(MHz)	$ S_{11} $	$\angle S_{11}$	$ S_{21} $	$\angle S_{21}$	$ S_{12} $	$\angle S_{12}$	$ S_{22} $	$\angle S_{22}$
100	0.874	-40.6	8.627	152.3	0.062	67.9	0.918	-23.4
200	0.785	-71.6	6.874	132.5	0.101	52.1	0.748	-41.7
400	0.651	-114.8	4.701	107.3	0.135	37.1	0.537	-57.6
600	0.613	-136.9	3.365	92.8	0.152	31.1	0.430	-65.6
800	0.581	-153.9	2.716	81.9	0.155	29.9	0.361	-74.3
1000	0.568	-164.2	2.218	73.4	0.161	30.0	0.326	-80.2
1200	0.556	-172.0	1.863	66.2	0.170	30.5	0.300	-86.1
1400	0.563	-178.1	1.626	59.6	0.177	32.7	0.297	-92.3
1600	0.558	175.4	1.473	53.9	0.185	35.4	0.306	-96.5
1800	0.560	168.9	1.345	48.1	0.196	37.4	0.313	-100.6
2000	0.567	163.1	1.230	42.5	0.205	38.0	0.335	-102.9

$V_{CE}=3V, I_C=7mA, Z_O=50\Omega$

Freq(MHz)	$ S_{11} $	$\angle S_{11}$	$ S_{21} $	$\angle S_{21}$	$ S_{12} $	$\angle S_{12}$	$ S_{22} $	$\angle S_{22}$
100	0.789	-48.3	16.232	147.7	0.039	66.1	0.862	-27.2
200	0.670	-83.7	12.431	126.4	0.061	53.0	0.673	-44.6
400	0.552	-123.8	7.607	104.7	0.081	45.2	0.438	-59.1
600	0.522	-145.3	5.401	92.7	0.094	45.9	0.333	-65.1
800	0.504	-158.5	4.155	84.1	0.106	48.2	0.290	-68.7
1000	0.488	-169.1	3.425	77.1	0.121	49.1	0.270	-71.0
1200	0.478	-176.1	2.849	71.0	0.136	51.0	0.253	-74.7
1400	0.481	178.4	2.511	65.6	0.152	52.2	0.239	-79.6
1600	0.478	172.7	2.237	60.7	0.167	52.8	0.240	-82.8
1800	0.492	167.4	2.016	55.5	0.185	53.2	0.245	-86.7
2000	0.489	162.0	1.844	50.5	0.200	52.7	0.248	-90.0

$V_{CE}=5V, I_C=20mA, Z_O=50\Omega$

Freq(MHz)	$ S_{11} $	$\angle S_{11}$	$ S_{21} $	$\angle S_{21}$	$ S_{12} $	$\angle S_{12}$	$ S_{22} $	$\angle S_{22}$
100	0.643	-66.4	26.381	137.4	0.029	62.8	0.748	-36.3
200	0.530	-104.6	17.543	116.5	0.041	54.2	0.531	-52.5
400	0.459	-140.3	9.835	98.9	0.058	55.4	0.322	-62.7
600	0.447	-157.2	6.805	89.4	0.074	59.2	0.246	-65.5
800	0.440	-168.4	5.210	82.4	0.092	61.4	0.213	-68.6
1000	0.434	-175.9	4.194	76.6	0.110	61.9	0.199	-70.2
1200	0.437	177.1	3.518	71.5	0.129	62.3	0.191	-72.9
1400	0.437	173.0	3.077	66.7	0.148	61.8	0.184	-76.5
1600	0.438	168.4	2.730	62.5	0.166	61.6	0.181	-80.9
1800	0.439	164.2	2.459	58.0	0.186	60.7	0.186	-84.8
2000	0.444	159.1	2.249	53.5	0.203	59.5	0.192	-87.3

- SANYO Semiconductor Co.,Ltd. assumes no responsibility for equipment failures that result from using products at values that exceed, even momentarily, rated values (such as maximum ratings, operating condition ranges, or other parameters) listed in products specifications of any and all SANYO Semiconductor Co.,Ltd. products described or contained herein.
- SANYO Semiconductor Co.,Ltd. strives to supply high-quality high-reliability products, however, any and all semiconductor products fail or malfunction with some probability. It is possible that these probabilistic failures or malfunction could give rise to accidents or events that could endanger human lives, trouble that could give rise to smoke or fire, or accidents that could cause damage to other property. When designing equipment, adopt safety measures so that these kinds of accidents or events cannot occur. Such measures include but are not limited to protective circuits and error prevention circuits for safe design, redundant design, and structural design.
- In the event that any or all SANYO Semiconductor Co.,Ltd. products described or contained herein are controlled under any of applicable local export control laws and regulations, such products may require the export license from the authorities concerned in accordance with the above law.
- No part of this publication may be reproduced or transmitted in any form or by any means, electronic or mechanical, including photocopying and recording, or any information storage or retrieval system, or otherwise, without the prior written consent of SANYO Semiconductor Co.,Ltd.
- Any and all information described or contained herein are subject to change without notice due to product/technology improvement, etc. When designing equipment, refer to the "Delivery Specification" for the SANYO Semiconductor Co.,Ltd. product that you intend to use.
- Information (including circuit diagrams and circuit parameters) herein is for example only; it is not guaranteed for volume production.
- Upon using the technical information or products described herein, neither warranty nor license shall be granted with regard to intellectual property rights or any other rights of SANYO Semiconductor Co.,Ltd. or any third party. SANYO Semiconductor Co.,Ltd. shall not be liable for any claim or suits with regard to a third party's intellectual property rights which has resulted from the use of the technical information and products mentioned above.

This catalog provides information as of October, 2009. Specifications and information herein are subject to change without notice.