

ZXTC2063E6

40V, SOT23-6, complementary medium power transistors

Summary

$BV_{CEO} > 40$ (-40)V

$BV_{ECO} > 6$ (-3)V

$I_{C(cont)} = 3.5$ (-3)A

$V_{CE(sat)} < 60$ (-90)mV @ 1A

$R_{CE(sat)} = 38$ (58)m Ω

$P_D = 1.1$ W

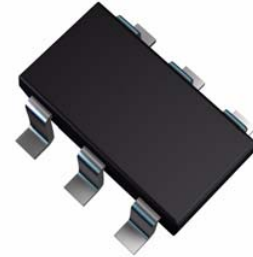

Description

Advanced process capability has been used to achieve this high performance device. Combining NPN and PNP transistors in the SOT23-6 package provides a compact solution for the intended applications.

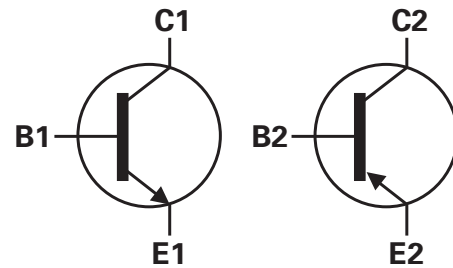

Features

- NPN - PNP combination
- Very low saturation voltage
- High gain
- SOT23-6 package

Applications

- MOSFET and IGBT gate driving
- Motor drive

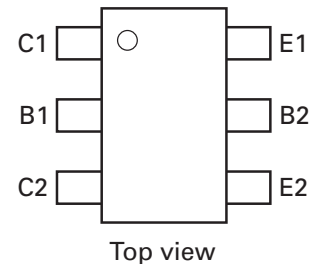

Ordering information

Device	reel size (inches)	Tape width (mm)	Quantity per reel
ZXTC2063E6TA	7	8	3000

Device marking

2063

Absolute maximum and thermal ratings

Parameter	Symbol	Limit	Unit
Collector-base voltage	V_{CBO}	130(-45)	V
Collector-emitter voltage	V_{CEO}	40(-40)	V
Emitter-collector voltage (reverse blocking)	V_{ECO}	6(-3)	V
Emitter-base voltage	V_{EBO}	7(-7)	V
Continuous collector current ^{(c)(f)}	I_C	3.5(-3)	A
Peak pulse current	I_{CM}	9(-9)	A
Base current	I_B	1(-1)	A
Power dissipation @ $T_{amb} = 25^\circ\text{C}^{(a)(f)}$		0.7	W
Linear derating factor	P_D	5.6	mW/°C
Power dissipation @ $T_{amb} = 25^\circ\text{C}^{(b)(f)}$		0.9	W
Linear derating factor	P_D	7.2	mW/°C
Power dissipation @ $T_{amb} = 25^\circ\text{C}^{(b)(g)}$		1.1	W
Linear derating factor	P_D	8.8	mW/°C
Power dissipation @ $T_{amb} = 25^\circ\text{C}^{(c)(f)}$		1.1	W
Linear derating factor	P_D	8.8	mW/°C
Power dissipation @ $T_{amb} = 25^\circ\text{C}^{(d)(f)}$		1.7	W
Linear derating factor	P_D	13.6	mW/°C
Operating and storage temperature range	T_j, T_{stg}	-55 to +150	°C
Thermal resistance junction to ambient ^{(a)(f)}	$R_{\theta JC}$	179	°C/W
Thermal resistance junction to ambient ^{(b)(f)}	$R_{\theta JA}$	139	°C/W
Thermal resistance junction to ambient ^{(b)(g)}	$R_{\theta JC}$	113	°C/W
Thermal resistance junction to ambient ^{(c)(f)}	$R_{\theta JC}$	113	°C/W
Thermal resistance junction to ambient ^{(d)(f)}	$R_{\theta JA}$	73	°C/W

NOTES:

- (a) For a device surface mounted on 15mm x 15mm x 1.6mm FR4 PCB with high coverage of single sided 1oz copper, in still air conditions.
- (b) For a device surface mounted on 25mm x 25mm x 1.6mm FR4 PCB with high coverage of single sided 1oz copper, in still air conditions.
- (c) For a device surface mounted on 50mm x 50mm x 1.6mm FR4 PCB with high coverage of single sided 2oz copper, in still air conditions.
- (d) As above measured at $t < 5$ seconds.
- (e) Repetitive rating - pulse width limited by maximum junction temperature. Refer to Transient Thermal Impedance graph.
- (f) For device with one active die, both collectors attached to a common sink.
- (g) For device with two active dice running at equal power, split sink 50% to each collector.

ZXTC2063E6

Thermal characteristics

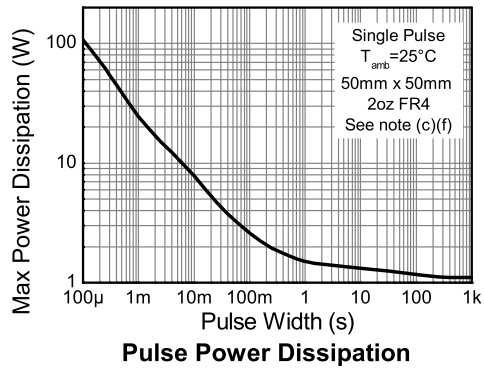
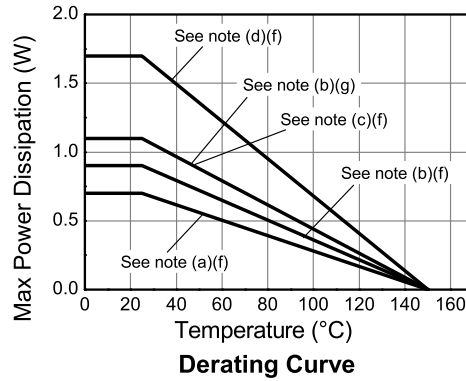
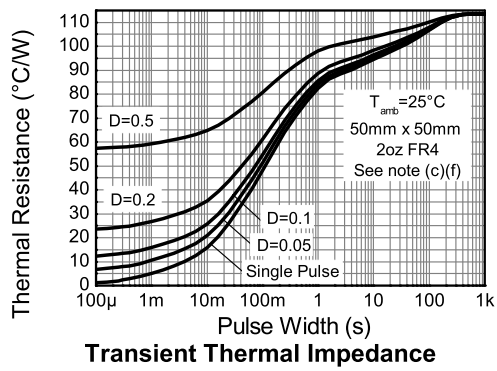
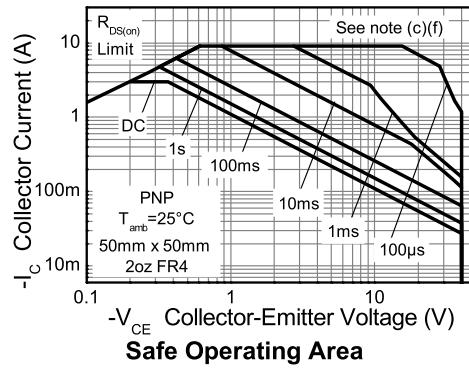
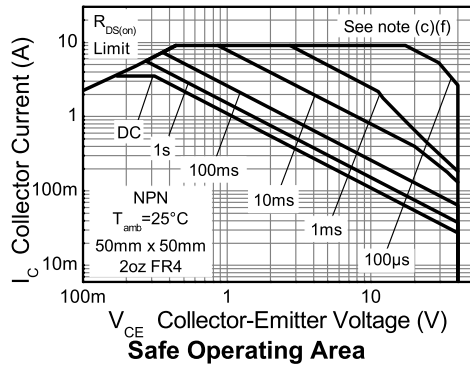

ZXTC2063E6

Electrical characteristics (at $T_{amb} = 25^{\circ}\text{C}$ unless otherwise stated)

Parameter	Symbol	Min.	Typ.	Max.	Unit	Conditions
Collector-base breakdown voltage	BV_{CBO}	130(-45)	170(-80)		V	$I_C = (-)100\mu\text{A}$
Collector-emitter breakdown voltage (base open)	BV_{CEO}	(-)40	63(-65)		V	$I_C = (-)10\text{mA}^{(*)}$ *
Emitter-base breakdown voltage	BV_{EBO}	(-)7	(-)8.3		V	$I_E = (-)100\mu\text{A}$
Emitter-collector breakdown voltage (reverse blocking)	BV_{ECX}	(-)6	(-)7.4		V	$I_E = (-)100\mu\text{A}$, $R_{BC} < 1\text{k}\Omega$ or $0.25\text{V} > V_{BC} > -0.25\text{V}$ ($0.25\text{V} < V_{BC} < -0.25\text{V}$)
Emitter-collector breakdown voltage (base open)	BV_{ECO}	6(-3)	7.4(-8.7)		V	$I_E = (-)100\mu\text{A}$
Collector-base cut-off current	I_{CBO}		<1	(-)50 (-)20	nA μA	$V_{CB} = 100(-36)\text{V}$ $V_{CB} = 100(-36)\text{V}$, $T_{amb} = 100^{\circ}\text{C}$
Emitter-base cut-off current	I_{EBO}		<1	(-)50	nA	$V_{EB} = (-)5.6\text{V}$
Collector-emitter saturation voltage	$V_{CE(sat)}$		50(-70) 85(-195) 150 (-175) 135	60(-90) 110(-290) 220 (-260) 195	mV mV mV mV mV	$I_C = (-)1\text{A}$, $I_B = (-)100\text{mA}$ * $I_C = (-)1\text{A}$, $I_B = (-)20\text{mA}$ * $I_C = 2\text{A}$, $I_B = 40\text{mA}$ * ($I_C = -3\text{A}$, $I_B = -300\text{mA}$ *) $I_C = 3.5\text{A}$, $I_B = 350\text{mA}$ *
Base-emitter saturation voltage	$V_{BE(sat)}$		(-935) 960	(-1000) 1050	mV mV	($I_C = -3\text{A}$, $I_B = -300\text{mA}$ *) $I_C = 3.5\text{A}$, $I_B = 350\text{mA}$ *
Base-emitter turn-on voltage	$V_{BE(on)}$		(-855) 860	(-950) 950	mV mV	($I_C = -3\text{A}$, $V_{CE} = -2\text{V}$ *) $I_C = 3.5\text{A}$, $V_{CE} = 2\text{V}$ *
Static forward current transfer ratio	h_{FE}	()300 280(200) (20) 40	()450 400(280) (50) 60	()900		$I_C = (-)10\text{mA}$, $V_{CE} = (-)2\text{V}$ * $I_C = (-)1\text{A}$, $V_{CE} = (-)2\text{V}$ * ($I_C = -3\text{A}$, $V_{CE} = -2\text{V}$ *) $I_C = 3.5\text{A}$, $V_{CE} = 2\text{V}$ *
Transition frequency	f_T		190 (270)		MHz	$I_C = (-)50\text{mA}$, $V_{CE} = (-)10\text{V}$ $f = 100\text{MHz}$
Output capacitance	C_{OBO}		12(17)	20(25)	pF	$V_{CB} = (-)10\text{V}$, $f = 1\text{MHz}$ *
Delay time	t_d		64(57)		ns	$V_{CC} = (-)10\text{V}$, $I_C = (-)1\text{A}$, $I_{B1} = I_{B2} = (-)10\text{mA}$.
Rise time	t_r		108(69)		ns	
Storage time	t_s		428(154)		ns	
Fall time	t_f		130(60)		ns	

NOTES:

(*) Measured under pulsed conditions. Pulse width $\leq 300\mu\text{s}$; duty cycle $\leq 2\%$

() = PNP

NPN Characteristics

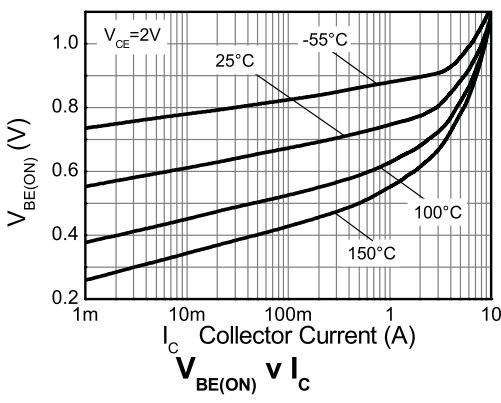
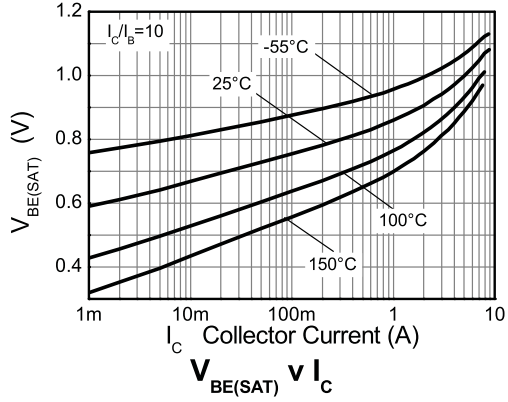
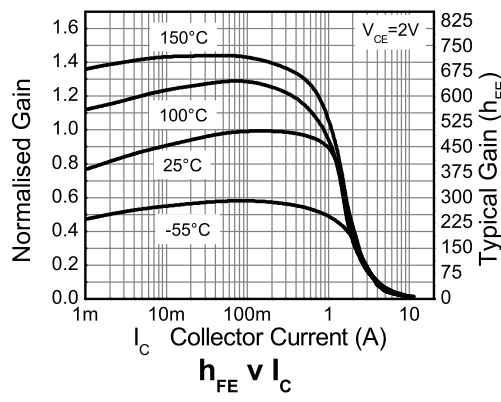
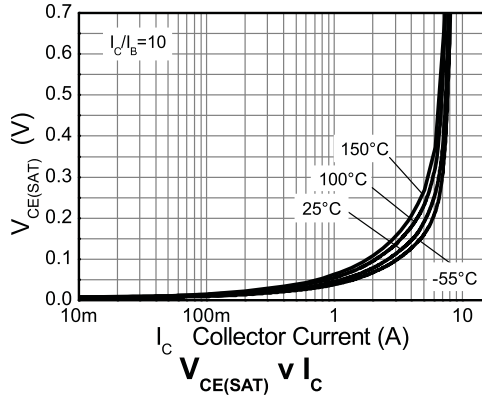
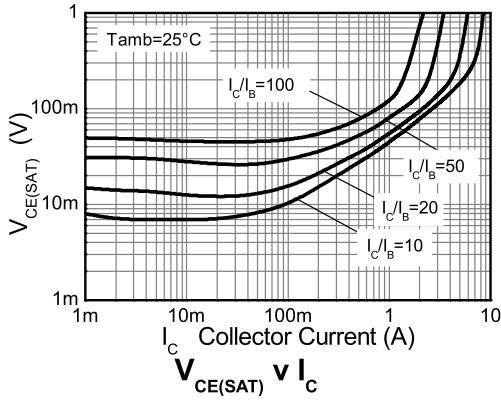

PNP Characteristics

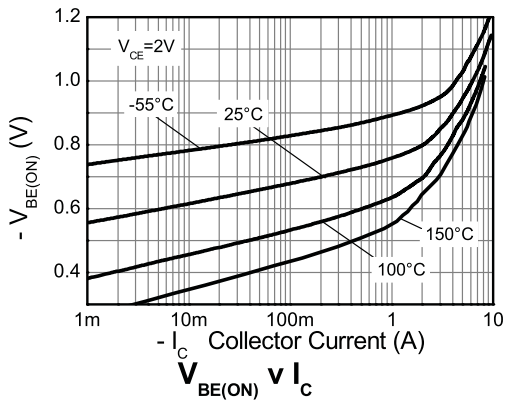
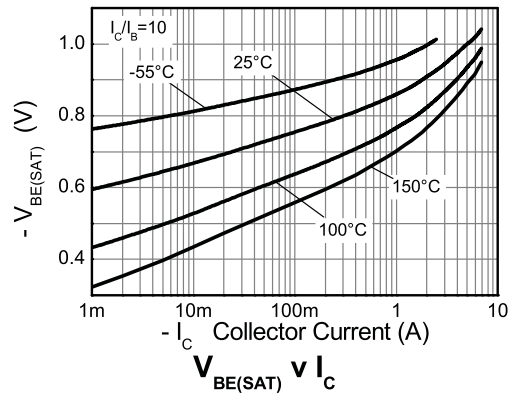
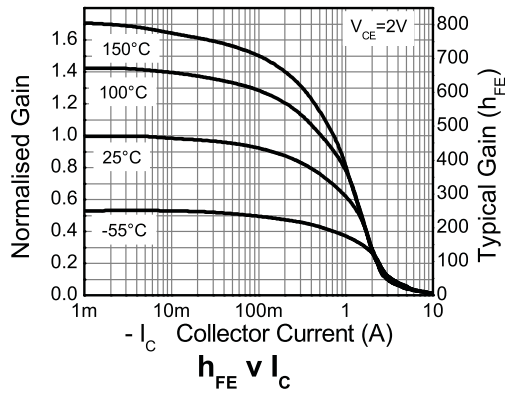
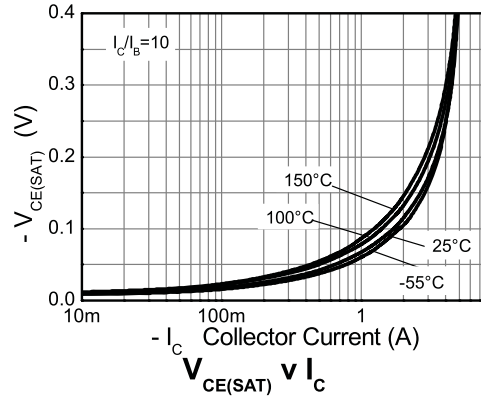
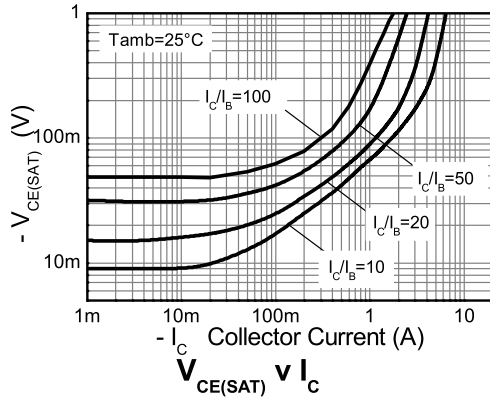

ZXTC2063E6

Package outline - SOT23-6

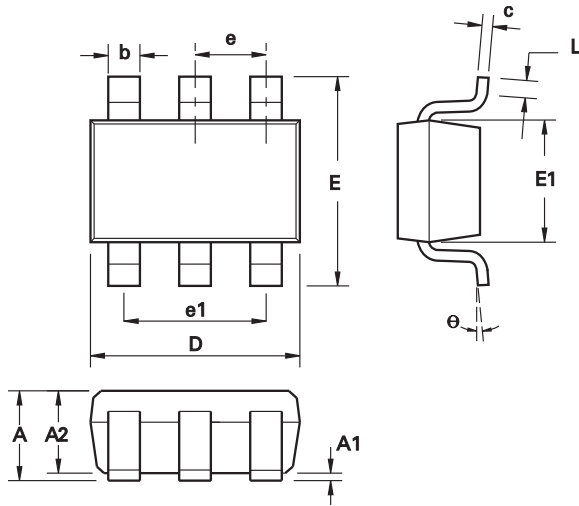

DIM	Millimeters		Inches	
	Min.	Max.	Min.	Max.
A	0.90	1.45	0.354	0.0570
A1	0.00	0.15	0.00	0.0059
A2	0.90	1.30	0.0354	0.0511
b	0.35	0.50	0.0078	0.0196
C	0.09	0.26	0.0035	0.0102
D	2.70	3.10	0.1062	0.1220
E	2.20	3.20	0.0866	0.1181
E1	1.30	1.80	0.0511	0.0708
L	0.10	0.60	0.0039	0.0236
e	0.95 REF		0.0374 REF	
e1	1.90 REF		0.0748 REF	
L	0°	30°	0°	30°

Note: Controlling dimensions are in millimeters. Approximate dimensions are provided in inches

Definitions

Product change

Diodes Incorporated reserves the right to alter, without notice, specifications, design, price or conditions of supply of any product or service. Customers are solely responsible for obtaining the latest relevant information before placing orders.

Applications disclaimer

The circuits in this design/application note are offered as design ideas. It is the responsibility of the user to ensure that the circuit is fit for the user's application and meets with the user's requirements. No representation or warranty is given and no liability whatsoever is assumed by Diodes Inc. with respect to the accuracy or use of such information, or infringement of patents or other intellectual property rights arising from such use or otherwise. Diodes Inc. does not assume any legal responsibility or will not be held legally liable (whether in contract, tort (including negligence), breach of statutory duty, restriction or otherwise) for any damages, loss of profit, business, contract, opportunity or consequential loss in the use of these circuit applications, under any circumstances.

Life support

Diodes Zetex products are specifically not authorized for use as critical components in life support devices or systems without the express written approval of the Chief Executive Officer of Diodes Incorporated. As used herein:

A. Life support devices or systems are devices or systems which:

1. are intended to implant into the body

or

2. support or sustain life and whose failure to perform when properly used in accordance with instructions for use provided in the labeling can be reasonably expected to result in significant injury to the user.

B. A critical component is any component in a life support device or system whose failure to perform can be reasonably expected to cause the failure of the life support device or to affect its safety or effectiveness.

Reproduction

The product specifications contained in this publication are issued to provide outline information only which (unless agreed by the company in writing) may not be used, applied or reproduced for any purpose or form part of any order or contract or be regarded as a representation relating to the products or services concerned.

Terms and Conditions

All products are sold subjects to Diodes Inc. terms and conditions of sale, and this disclaimer (save in the event of a conflict between the two when the terms of the contract shall prevail) according to region, supplied at the time of order acknowledgement.

For the latest information on technology, delivery terms and conditions and prices, please contact your nearest Diodes Zetex sales office.

Quality of product

Diodes Zetex Semiconductors Limited is an ISO 9001 and TS16949 certified semiconductor manufacturer.

To ensure quality of service and products we strongly advise the purchase of parts directly from Diodes Inc. or one of our regionally authorized distributors. For a complete listing of authorized distributors please visit: www.zetex.com or www.diodes.com

Diodes Inc. does not warrant or accept any liability whatsoever in respect of any parts purchased through unauthorized sales channels.

ESD (Electrostatic discharge)

Semiconductor devices are susceptible to damage by ESD. Suitable precautions should be taken when handling and transporting devices. The possible damage to devices depends on the circumstances of the handling and transporting, and the nature of the device. The extent of damage can vary from immediate functional or parametric malfunction to degradation of function or performance in use over time. Devices suspected of being affected should be replaced.

Green compliance

Diodes Inc. is committed to environmental excellence in all aspects of its operations which includes meeting or exceeding regulatory requirements with respect to the use of hazardous substances. Numerous successful programs have been implemented to reduce the use of hazardous substances and/or emissions.

All Diodes Zetex components are compliant with the RoHS directive, and through this it is supporting its customers in their compliance with WEEE and ELV directives.

Product status key:

"Preview"	Future device intended for production at some point. Samples may be available
"Active"	Product status recommended for new designs
"Last time buy (LTB)"	Device will be discontinued and last time buy period and delivery is in effect
"Not recommended for new designs"	Device is still in production to support existing designs and production
"Obsolete"	Production has been discontinued

Datasheet status key:

"Draft version"	This term denotes a very early datasheet version and contains highly provisional information, which may change in any manner without notice.
"Provisional version"	This term denotes a pre-release datasheet. It provides a clear indication of anticipated performance. However, changes to the test conditions and specifications may occur, at any time and without notice.
"Issue"	This term denotes an issued datasheet containing finalized specifications. However, changes to specifications may occur, at any time and without notice.

Sales offices

The Americas	Europe	Taiwan	Shanghai	Shenzhen	Korea
3050 E. Hillcrest Drive Westlake Village, CA 91362-3154 Tel: (+1) 805 446 4800 Fax: (+1) 805 446 4850	Kustermann-Park Balanstraße 59, D-81541 München Germany Tel: (+49) 894 549 490 Fax: (+49) 894 549 4949	7F, No. 50, Min Chuan Road Hsin-Tien Taipei, Taiwan Tel: (+886) 289 146 000 Fax: (+886) 289 146 639	Rm. 606, No.1158 Changning Road Shanghai, China Tel: (+86) 215 241 4882 Fax: (+86) 215 241 4891	ANLIAN Plaza, #4018 Jintian Road Futian CBD, Shenzhen, China Tel: (+86) 755 882 849 88 Fax: (+86) 755 882 849 99	6 Floor, Changhwa B/D, 1005-5 Yeongtong-dong, Yeongtong-gu, Suwon-si, Gyeonggi-do, Korea 443-813 Tel: (+82) 312 731 884 Fax: (+82) 312 731 885