

PWM Control & PWM/PFM Control Step-Down Switching Regulator-Controllers

S-8520/8521 Series

The S-8520/8521 Series consists of CMOS step-down switching regulator-controllers with PWM-control (S-8520) and PWM/PFM-switched control (S-8521). These devices contain a reference voltage source, oscillation circuit, error amplifier, and other components.

The S-8520 Series provides low-ripple power, high-efficiency, and excellent transient characteristics thanks to a PWM control circuit capable of varying the duty ratio linearly from 0 % up to 100 %. The series also contains an error amplifier circuit as well as a soft-start circuit that prevents overshoot at startup.

The S-8521 Series works with either PWM control or PFM control, and can switch from one to the other. It normally operates using PWM control with a duty ratio of 25 % to 100 %, but under a light load, it automatically switches to PFM control with a duty ratio of 25 %. This series ensures high efficiency over a wide range of conditions, from standby mode to operation of peripheral equipment.

With the addition of an external Pch Power MOS FET or PNP transistor, a coil, capacitors, and a diode connected externally, these ICs can function as step-down switching regulators. They serve as ideal power supply units for portable devices when coupled with the SOT-23-5 minipackage, providing such outstanding features as low current consumption. Since this series can accommodate an input voltage of up to 16 V, it is also ideal when operating via an AC adapter.

■ Features:

- Low current consumption:
 - In operation: 60 μ A max. (A & B Series)
 - 21 μ A max. (C & D Series)
 - 100 μ A max. (E & F Series)
 - When powered off: 0.5 μ A max.
- Input voltage:
 - 2.5 V to 16 V (B, D, F Series)
 - 2.5 V to 10 V (A, C, E Series)
- Output voltage:
 - Selectable between 1.5 V and 6.0 V in 0.1 V step
- Duty ratio:
 - 0 % to 100 % PWM control (S-8520)
 - 25 % to 100 % PWM/PFM-switched control (S-8521)
- The only peripheral components that can be used with this IC are a Pch power MOS FET or PNP transistor, a coil, a diode, and capacitors (If a PNP transistor is used, a base resistance and a capacitor will also be required).
- Oscillation frequency: 180 kHz typ. (A & B Series), 60 kHz typ. (C & D Series), or 300 kHz typ. (E, F Series).
- Soft-start function: 8 ms. typ. (A & B Series) 12 ms. typ.(C & D Series), or 4.5 ms. typ. (E, F Series).
- With a power-off function.
- With a built-in overload protection circuit. Overload detection time: 4 ms. typ. (A Series), 14 ms. typ. (C Series) or 2.6 ms. typ.(E Series).

■ Applications:

- On-board power supplies of battery devices for portable telephones, electronic notebooks, PDAs, and the like.
- Power supplies for audio equipment, including portable CD players and headphone stereo equipment.
- Fixed voltage power supply for cameras, video equipment and communications equipment.
- Power supplies for microcomputers.
- Conversion from four NiH or NiCd cells or two lithium-ion cells to 3.3 V/3 V.
- Conversion of AC adapter input to 5 V/3 V.

■ Block Diagram:

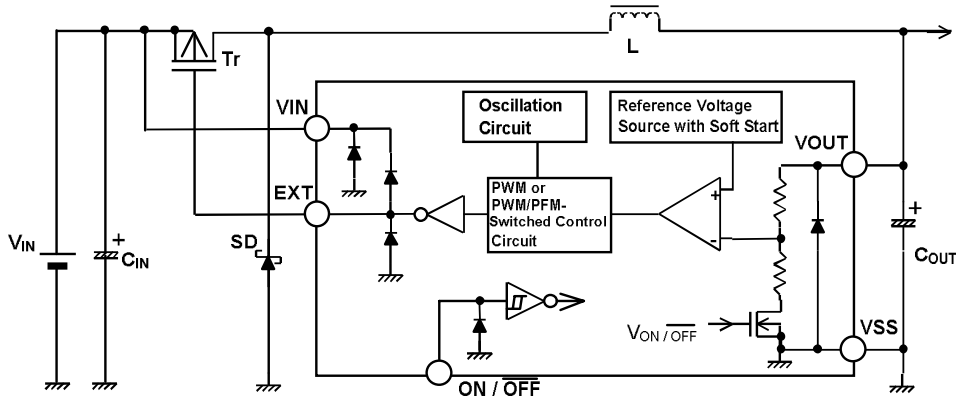

Note: The diode inside the IC is a parasitic diode.

Figure 1 Block Diagram

■ Selection Guide:

1. Product Name

S - 852 X X XX MC - XXX - T2

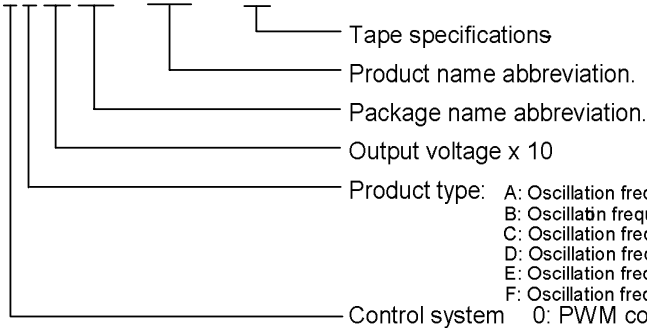

Tape specifications

Product name abbreviation.

Package name abbreviation.

Output voltage x 10

Product type: A: Oscillation frequency of 180 kHz, with overload protection circuit.
 B: Oscillation frequency of 180 kHz, without overload protection circuit.
 C: Oscillation frequency of 60 kHz, with overload protection circuit.
 D: Oscillation frequency of 60 kHz, without overload protection circuit.
 E: Oscillation frequency of 300 kHz, with overload protection circuit.
 F: Oscillation frequency of 300 kHz, without overload protection circuit.

Control system 0: PWM control

1: PWM/PFM-switched control

PWM Control & PWM/PFM Control Step-Down Switching Regulator-Controllers
Rev.7.4 10 **S-8520/8521 Series**

2. Product List (As of September 1, 2000)

A & B Series (Oscillation Frequency of 180 kHz)

Item Output Voltage (V)	S-8520AXXMC Series	S-8521AXXMC Series	S-8520BXXMC Series	S-8521BXXMC Series
1.6	—	—	—	—
1.8	—	—	S-8520B18MC-ARD-T2	S-8521B18MC-ATD-T2
1.9	—	—	—	S-8521B19MC-ATE-T2
2.0	—	—	—	S-8521B20MC-ATF-T2
2.1	S-8520A21MC-AVG-T2	—	—	S-8521B21MC-ATG-T2
2.5	S-8520A25MC-AVK-T2	S-8521A25MC-AXK-T2	S-8520B25MC-ARK-T2	S-8521B25MC-ATK-T2
2.7	S-8520A27MC-AVM-T2	S-8521A27MC-AXM-T2	S-8520B27MC-ARM-T2	S-8521B27MC-ATM-T2
2.8	S-8520A28MC-AVN-T2	S-8521A28MC-AXN-T2	S-8520B28MC-ARN-T2	S-8521B28MC-ATN-T2
2.9	S-8520A29MC-AVO-T2	S-8521A29MC-AXO-T2	S-8520B29MC-ARO-T2	S-8521B29MC-ATO-T2
3.0	S-8520A30MC-AVP-T2	S-8521A30MC-AXP-T2	S-8520B30MC-ARP-T2	S-8521B30MC-ATP-T2
3.1	S-8520A31MC-AVQ-T2	S-8521A31MC-AXQ-T2	S-8520B31MC-ARQ-T2	S-8521B31MC-ATQ-T2
3.2	S-8520A32MC-AVR-T2	S-8521A32MC-AXR-T2	S-8520B32MC-ARR-T2	S-8521B32MC-ATR-T2
3.3	S-8520A33MC-AVS-T2	S-8521A33MC-AXS-T2	S-8520B33MC-ARS-T2	S-8521B33MC-ATS-T2
3.4	S-8520A34MC-AVT-T2	S-8521A34MC-AXT-T2	S-8520B34MC-ART-T2	S-8521B34MC-ATT-T2
3.5	S-8520A35MC-AVU-T2	S-8521A35MC-AXU-T2	S-8520B35MC-ARU-T2	S-8521B35MC-ATU-T2
3.6	S-8520A36MC-AVV-T2	S-8521A36MC-AXV-T2	S-8520B36MC-ARV-T2	S-8521B36MC-ATV-T2
5.0	S-8520A50MC-AWJ-T2	S-8521A50MC-AYJ-T2	S-8520B50MC-ASJ-T2	S-8521B50MC-AUJ-T2

C & D Series (Oscillation Frequency of 60 kHz)

Item Output Voltage (V)	S-8520CXXMC Series	S-8521CXXMC Series	S-8520DXXMC Series	S-8521DXXMC Series
1.6	—	S-8521C16MC-BTB-T2	—	S-8521D16MC-BXB-T2
2.0	—	—	—	S-8521D20MC-BXF-T2
2.5	S-8520C25MC-BRK-T2	S-8521C25MC-BTK-T2	S-8520D25MC-BVK-T2	S-8521D25MC-BXK-T2
2.7	S-8520C27MC-BRM-T2	S-8521C27MC-BTM-T2	S-8520D27MC-BVM-T2	S-8521D27MC-BXM-T2
2.8	S-8520C28MC-BRN-T2	S-8521C28MC-BTN-T2	S-8520D28MC-BVN-T2	S-8521D28MC-BXN-T2
2.9	S-8520C29MC-BRO-T2	S-8521C29MC-BTO-T2	S-8520D29MC-BVO-T2	S-8521D29MC-BXO-T2
3.0	S-8520C30MC-BRP-T2	S-8521C30MC-BTP-T2	S-8520D30MC-BVP-T2	S-8521D30MC-BXP-T2
3.1	S-8520C31MC-BRQ-T2	S-8521C31MC-BTQ-T2	S-8520D31MC-BVQ-T2	S-8521D31MC-BXQ-T2
3.2	S-8520C32MC-BRR-T2	S-8521C32MC-BTR-T2	S-8520D32MC-BVR-T2	S-8521D32MC-BXR-T2
3.3	S-8520C33MC-BRS-T2	S-8521C33MC-BTS-T2	S-8520D33MC-BVS-T2	S-8521D33MC-BXS-T2
3.4	S-8520C34MC-BRT-T2	S-8521C34MC-BTT-T2	S-8520D34MC-BVT-T2	S-8521D34MC-BXT-T2
3.5	S-8520C35MC-BRU-T2	S-8521C35MC-BTU-T2	S-8520D35MC-BVU-T2	S-8521D35MC-BXU-T2
3.6	S-8520C36MC-BRV-T2	S-8521C36MC-BTV-T2	S-8520D36MC-BVV-T2	S-8521D36MC-BXV-T2
5.0	S-8520C50MC-BSJ-T2	S-8521C50MC-BUJ-T2	S-8520D50MC-BVJ-T2	S-8521D50MC-BYJ-T2

E & F Series (Oscillation Frequency of 300 kHz)

Item Output Voltage (V)	S-8520EXXMC Series	S-8521EXXMC Series	S-8520FXXMC Series	S-8521FXXMC Series
1.5	—	S-8521E15MC-BLA-T2	—	—
1.8	S-8520E18MC-BJD-T2	S-8521E18MC-BLD-T2	S-8520F18MC-BND-T2	S-8521F18MC-BPD-T2
2.0	—	S-8521E20MC-BLF-T2	—	—
2.5	S-8520E25MC-BJK-T2	—	S-8520F25MC-BNK-T2	—
2.7	—	—	S-8520F27MC-BNM-T2	—
3.0	S-8520E30MC-BJP-T2	S-8521E30MC-BLP-T2	S-8520F30MC-BNP-T2	S-8521F30MC-BPP-T2
3.3	S-8520E33MC-BJS-T2	S-8521E33MC-BLS-T2	S-8520F33MC-BNS-T2	S-8521F33MC-BPS-T2
3.4	—	—	S-8520F34MC-BNT-T2	—
3.5	—	S-8521E35MC-BLU-T2	—	—
5.0	S-8520E50MC-BKJ-T2	S-8521E50MC-BMJ-T2	S-8520F50MC-BOJ-T2	S-8521F50MC-BQJ-T2

For the availability of product samples listed above, contact the SII Sales Department.

■ Pin Assignment:

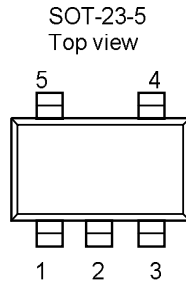

Figure 2

Pin No.	Pin Name	Function
1	ON/OFF	Power-off pin H: Normal operation (Step-down operation) L: Step-down operation stopped (All circuits deactivated)
2	VSS	GND pin
3	VOUT	Output voltage monitoring pin
4	EXT	Connection pin for external transistor
5	VIN	IC power supply pin

■ Absolute Maximum Ratings:

(Ta = 25 °C unless otherwise specified)

Item	Symbol	Ratings	Unit
VIN pin voltage	V_{IN}^{*1}	$V_{SS}-0.3$ to $V_{SS}+12$ or $V_{SS}+18$	V
VOUT pin voltage	V_{OUT}	$V_{SS}-0.3$ to $V_{SS}+12$ or $V_{SS}+18$	V
ON/OFF pin voltage	$V_{ON/OFF}^{*1}$	$V_{SS}-0.3$ to $V_{SS}+12$ or $V_{SS}+18$	V
EXT pin voltage	V_{EXT}	$V_{SS}-0.3$ to $V_{IN}+0.3$	V
EXT pin current	I_{EXT}	±50	mA
Power dissipation	P_D	250	mW
Operating temperature range	T_{OPR}	-40 to +85	°C
Storage temperature range	T_{STG}	-40 to +125	°C

*1. $V_{SS}+12$ V for S-8520/21A/C/E; $V_{SS}+18$ V for S-8520/21B/D/F

Caution The absolute maximum ratings are rated values exceeding which the product could suffer physical damage. These values must therefore not be exceeded under any conditions.

■ **Electrical Characteristics:**

1. S-8520/21 A & B Series

(Ta =25 °C, unless otherwise specified)

Parameter	Symbol	Conditions	Min.	Typ.	Max.	Units	Measurement Circuit	
Output voltage ^{*1}	V _{OUT(E)}	–	V _{OUT(S)} × 0.976	V _{OUT(S)}	V _{OUT(S)} × 1.024	V	3	
Input voltage	V _{IN}	S-8520/21A Series	2.5	–	10.0	V	2	
		S-8520/21B Series	2.5	–	16.0			
Current consumption 1	I _{SS1}	V _{OUT} = V _{OUT(S)} × 1.2	–	35	60	μA	2	
Current consumption during power off	I _{SSS}	V _{ON/OFF} = 0 V	–	–	0.5	μA	2	
EXT pin output current	I _{EXTH}	V _{EXT} = V _{IN} - 0.4 V	S-8520/21X15 – 24	-2.3	-4.5	–	mA	–
			S-8520/21X25 – 34	-3.7	-7.0	–		
			S-8520/21X35 – 44	-5.3	-9.3	–		
			S-8520/21X45 – 54	-6.7	-11.3	–		
	I _{EXTL}	V _{EXT} = 0.4 V	S-8520/21X15 – 24	+4.3	+8.4	–		
			S-8520/21X25 – 34	+7.0	+13.2	–		
			S-8520/21X35 – 44	+9.9	+17.5	–		
			S-8520/21X45 – 54	+12.6	+21.4	–		
S-8520/21X55 – 60	+15.0	+25.1	–					
Line regulation	ΔV _{OUT1}	V _{IN} = V _{OUT(S)} × 1.2 to × 1.4 ^{*4}	–	30	60	mV	3	
Load regulation	ΔV _{OUT2}	Load current = 10μA to I _{OUT} (See below) × 1.25	–	30	60	mV	3	
Output voltage temperature coefficient	ΔV _{OUT} / ΔTa	Ta = -40 °C to 85 °C	–	±V _{OUT(S)} × 5E-5	–	V/°C	3	
Oscillation frequency	f _{osc}	Measure waveform at EXT pin	V _{OUT(S)} ≥ 2.5 V	153	180	207	kHz	3
			V _{OUT(S)} ≤ 2.4 V	144	180	216		
PWM/PFM-control switch duty ratio ^{*2}	PFM Duty	Measure waveform at EXT pin under no load.	15	25	40	%	3	
Power-Off pin input voltage	V _{SH}	Evaluate oscillation at EXT pin	1.8	–	–	V	2	
	V _{SL}	Evaluate oscillation stop at EXT pin	–	–	0.3			
Power-Off pin input leakage current	I _{SH}	–	-0.1	–	0.1	μA	1	
	I _{SL}	–	-0.1	–	0.1	μA	1	
Soft-Start time	T _{SS}	–	4.0	8.0	16.0	ms	3	
Overload detection time ^{*3}	T _{PRO}	Duration from the time V _{OUT} is reduced to 0 V to the time the EXT pin obtains V _{IN} .	2.0	4.0	8.0	ms	2	
Efficiency	EFFI	–	–	93	–	%	3	

Conditions:

The recommended components are connected to the IC, unless otherwise indicated. V_{IN} = V_{OUT(S)} × 1.2 [V], I_{OUT} = 120 [mA] (V_{IN} = 2.5 V, if V_{OUT(S)} ≤ 2.0 V.)

Peripheral components:

Coil : Sumida Electric Co., Ltd. CD54 (47 μH).
 Diode : Matsushita Electronics Corporation MA720 (Schottky type).
 Capacitor : Matsushita Electronics Corporation TE (16 V, 22 μF tantalum type).
 Transistor : Toshiba Corporation 2SA1213Y.
 Base resistance (R_b) : 0.68 kΩ
 Base capacitor (C_b) : 2200 pF (Ceramic type)

The power-off pin is connected to V_{IN}.

Notes:

The output voltage indicated above represents a typical output voltage set up. These specifications apply in common to both S-8520 and S-8521, unless otherwise noted.

- *1. V_{OUT(S)} Specified output voltage value.
 V_{OUT(E)} Actual output voltage value.
- *2. Applicable to the S-8521A Series and S-8521B Series.
- *3. Applicable to the S-8520A Series and S-8521A Series.
- *4. V_{IN} = 2.5 V to 2.94 V, if V_{OUT(S)} ≤ 2.0 V.

2. S-8520/21 C & D Series

(Ta = 25 °C unless otherwise specified)

Parameter	Symbol	Conditions	Min.	Typ.	Max.	Units	Measurement Circuit	
Output voltage *1	V _{OUT(E)}	–	V _{OUT(S)} × 0.976	V _{OUT(S)}	V _{OUT(S)} × 1.024	V	3	
Input voltage	V _{IN}	S-8520/21C Series	2.5	–	10.0	V	2	
		S-8520/21D Series	2.5	–	16.0			
Current consumption 1	I _{SS1}	V _{OUT} = V _{OUT(S)} × 1.2	–	10	21	μA	2	
Current consumption during power-off	I _{SSS}	V _{ON/OFF} = 0 V	–	–	0.5	μA	2	
EXT pin output current	I _{EXTH}	V _{EXT} = V _{IN} – 0.4 V	S-8520/21X15 – 24	–2.3	–4.5	–	mA	–
			S-8520/21X25 – 34	–3.7	–7.0	–		
			S-8520/21X35 – 44	–5.3	–9.3	–		
			S-8520/21X45 – 54	–6.7	–11.3	–		
			S-8520/21X55 – 60	–8.0	–13.3	–		
	I _{EXTL}	V _{EXT} = 0.4 V	S-8520/21X15 – 24	+4.3	+8.4	–		
			S-8520/21X25 – 34	+7.0	+13.2	–		
			S-8520/21X35 – 44	+9.9	+17.5	–		
			S-8520/21X45 – 54	+12.6	+21.4	–		
			S-8520/21X55 – 60	+15.0	+25.1	–		
Line regulation	ΔV _{OUT1}	V _{IN} = V _{OUT(S)} × 1.2 to × 1.4 *4	–	30	60	mV	3	
Load regulation	ΔV _{OUT2}	Load current = 10 μA to I _{OUT} (See below) × 1.25	–	30	60	mV	3	
Output voltage temperature coefficient	ΔV _{OUT} / ΔTa	Ta = –40 °C to 85 °C	–	± V _{OUT(S)} × 5E-5	–	V/°C	3	
Oscillation frequency	f _{osc}	Measure waveform at EXT pin	V _{OUT(S)} ≥ 2.5 V	48	60	72	kHz	3
			V _{OUT(S)} ≤ 2.4 V	45	60	75		
PWM/PFM-control switch duty ratio *2	PFM Duty	Measure waveform at EXT pin under no load.	15	25	40	%	3	
Power-Off pin input voltage	V _{SH}	Evaluate oscillation at EXT pin	1.8	–	–	V	2	
	V _{SL}	Evaluate oscillation stop at EXT pin	–	–	0.3			
Power-Off pin input leakage current	I _{SH}	–	–0.1	–	0.1	μA	1	
	I _{SL}	–	–0.1	–	0.1	μA	1	
Soft-Start time	T _{SS}	–	6.0	12.0	24.0	ms	3	
Overload detection time *3	T _{PRO}	Duration from the time V _{OUT} is reduced to 0 V to the time the EXT pin obtains V _{IN} .	7.0	14.0	28.0	ms	2	
Efficiency	EFFI	–	–	93	–	%	3	

Conditions:

The recommended components are connected to the IC, unless otherwise indicated. V_{IN} = V_{OUT} × 1.2 [V],

I_{OUT} = 120 [mA] (V_{IN} = 2.5 V, if V_{OUT(S)} ≤ 2.0 V.)

Peripheral components:

- Coil : Sumida Electric Co., Ltd. CD54 (47 μH).
- Diode : Matsushita Electronics Corporation MA720 (Schottky type).
- Capacitor : Matsushita Electronics Corporation TE (16 V, 22 μF tantalum type).
- Transistor : Toshiba Corporation 2SA1213Y.
- Base resistance (R_b) : 0.68 kΩ
- Base capacitor (C_b) : 2200 pF (Ceramic type)

The power-off pin is connected to V_{IN}.

Notes:

The output voltage indicated above represents a typical output voltage set up. These specifications apply in common to both S-8520 and S-8521, unless otherwise noted.

- *1. V_{OUT(S)} Specified output voltage value.
V_{OUT(E)} Actual output voltage value.
- *2. Applicable to the S-8521C Series and S-8521D Series.
- *3. Applicable to the S-8520C Series and S-8521C Series.
- *4. V_{IN} = 2.5 V to 2.94 V, if V_{OUT(S)} ≤ 2.0 V.

3. S-8520/21 E & F Series

(Ta = 25 °C unless otherwise specified)

Parameter	Symbol	Conditions	Min.	Typ.	Max.	Units	Measurement Circuit	
Output voltage *1	V _{OUT(E)}	–	V _{OUT(S)} ×0.976	V _{OUT(S)}	V _{OUT(S)} ×1.024	V	3	
Input voltage	V _{IN}	S-8520/21E Series	2.5	–	10.0	V	2	
		S-8520/21F Series	2.5	–	16.0			
Current consumption 1	I _{SS1}	V _{OUT} = V _{OUT(S)} × 1.2	–	60	100	μA	2	
Current consumption during power-off	I _{SSS}	V _{ON/OFF} = 0 V	–	–	0.5	μA	2	
EXT pin output current	I _{EXTH}	V _{EXT} = V _{IN} - 0.4 V	S-8520/21X15 – 24	-2.3	-4.5	–	mA	–
			S-8520/21X25 – 34	-3.7	-7.0	–		
			S-8520/21X35 – 44	-5.3	-9.3	–		
			S-8520/21X45 – 54	-6.7	-11.3	–		
			S-8520/21X55 – 60	-8.0	-13.3	–		
	I _{EXTL}	V _{EXT} = 0.4 V	S-8520/21X15 – 24	+4.3	+8.4	–		
			S-8520/21X25 – 34	+7.0	+13.2	–		
			S-8520/21X35 – 44	+9.9	+17.5	–		
			S-8520/21X45 – 54	+12.6	+21.4	–		
			S-8520/21X55 – 60	+15.0	+25.1	–		
Line regulation	ΔV _{OUT1}	V _{IN} = V _{OUT(S)} × 1.2 to × 1.4 *4	–	30	60	mV	3	
Load regulation	ΔV _{OUT2}	Load current = 10 μA to I _{OUT} (See below) × 1.25	–	30	60	mV	3	
Output voltage temperature coefficient	ΔV _{OUT} / ΔTa	Ta = -40 °C to 85 °C	–	± V _{OUT} × 5E-5	–	V/°C	3	
Oscillation frequency	f _{osc}	Measure waveform at EXT pin	V _{OUT} ≥ 2.5 V	240	300	360	kHz	3
			V _{OUT} ≤ 2.4 V	225	300	375		
PWM/PFM-control switch duty ratio *2	PFM Duty	Measure waveform at EXT pin under no load.	15	25	40	%	3	
Power-Off pin input voltage	V _{SH}	Evaluate oscillation at EXT pin	1.8	–	–	V	2	
	V _{SL}	Evaluate oscillation stop at EXT pin	–	–	0.3			
Power-Off pin input leakage current	I _{SH}	–	-0.1	–	0.1	μA	1	
	I _{SL}	–	-0.1	–	0.1	μA	1	
Soft-Start time	T _{SS}	–	2.0	4.5	9.2	ms	3	
Overload detection time *3	T _{PRO}	Duration from the time V _{OUT} is reduced to 0 V to the time the EXT pin obtains V _{IN} .	1.3	2.6	4.5	ms	2	
Efficiency	EFFI	–	–	90	–	%	3	

Conditions:

The recommended components are connected to the IC, unless otherwise indicated. V_{IN} = V_{OUT} × 1.2 [V],

I_{OUT} = 120 [mA] (V_{IN} = 2.5 V, if V_{OUT(S)} ≤ 2.0 V.)

Peripheral components:

- Coil : Sumida Electric Co., Ltd. CD54 (47 μH).
- Diode : Matsushita Electronics Corporation MA720 (Schottky type).
- Capacitor : Matsushita Electronics Corporation TE (16 V, 22 μF tantalum type).
- Transistor : Toshiba Corporation 2SA1213Y.
- Base resistance (R_b) : 0.68 kΩ
- Base capacitor (C_b) : 2200 pF (Ceramic type)

The power-off pin is connected to V_{IN}.

Notes:

The output voltage indicated above represents a typical output voltage set up. These specifications apply in common to both S-8520 and S-8521, unless otherwise noted.

- *1. V_{OUT(S)} Specified output voltage value.
V_{OUT(E)} Actual output voltage value.
- *2. Applicable to the S-8521E Series and S-8521F Series.
- *3. Applicable to the S-8520E Series and S-8521E Series.
- *4. V_{IN} = 2.5 V to 2.94 V, if V_{OUT(S)} ≤ 2.0 V.

■ Measurement Circuits:

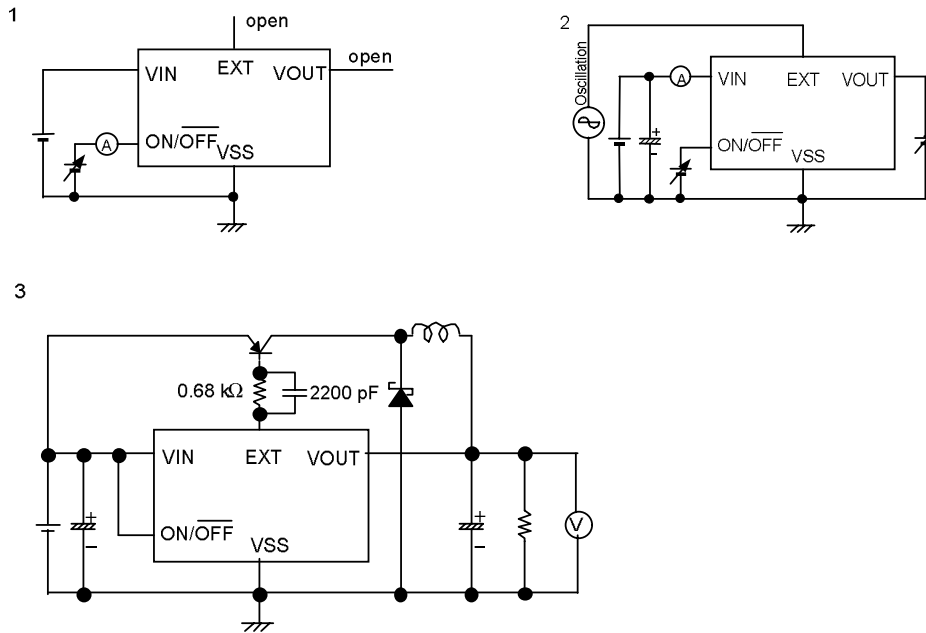

Figure 3

■ Operation:

1. Step-Down DC-DC Converter

1.1 PWM Control (S-8520 Series)

The S-8520 Series consists of DC/DC converters that employ a pulse-width modulation (PWM) system. This series is characterized by its low current consumption. In conventional PFM system DC/DC converters, pulses are skipped when they are operated with a low output load current, causing variations in the ripple frequency of the output voltage and an increase in the ripple voltage. Both of these effects constitute inherent drawbacks to those converters.

In converters of the S-8520 Series, the pulse width varies in a range from 0 % to 100 %, according to the load current, and yet ripple voltage produced by the switching can easily be removed through a filter because the switching frequency remains constant. Therefore, these converters provide a low-ripple power over broad ranges of input voltage and load current.

1.2 PWM/PFM-Switched Control (S-8521 Series)

The S-8521 Series consists of DC/DC converters capable of automatically switching the pulse-wide modulation system (PWM) over to the pulse-frequency modulation system (PFM), and vice versa, according to the load current. This series of converters features low current consumption.

In a region of high output load currents, the S-8521 Series converters function with PWM control, where the pulse-width duty varies from 25 % to 100 %. This function helps keep the ripple power low.

For certain low output load currents, the converters are switched over to PFM control, whereby pulses having their pulse-width duty fixed at 25 % are skipped depending on the quantity of the load current, and are output to a switching transistor. This causes the oscillation circuit to produce intermittent oscillation. As a result, current consumption is reduced and efficiency losses are prevented under low loads. Especially for output load currents in the region of 100 μ A, these DC/DC converters can operate at extremely high efficiency.

2. Power-Off Pin (ON/OFF Pin)

This pin deactivates or activates the step-down operation. When the power-off pin is set to "L", the V_{IN} voltage appears through the EXT pin, prodding the switching transistor to go off. All the internal circuits stop working, and substantial savings in current consumption are thus achieved.

The power-off pin is configured as shown in Figure 4. Since pull-up or pull-down is not performed internally, please avoid operating the pin in a floating state. Also, try to refrain from applying a voltage of 0.3 V to 1.8 V to the pin, lest the current consumption increase. When this power-off pin is not used, leave it coupled to the VIN pin.

Power-Off Pin	CR Oscillation Circuit	Output Voltage
"H"	Activated	Set value
"L"	Deactivated	V_{SS}

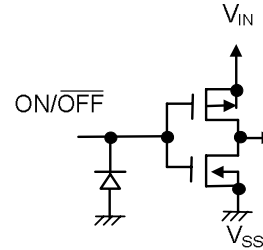

Figure 4

3. Soft-Start Function

The S-8520/21 Series comes with a built-in soft-start circuit. This circuit enables the output voltage to rise gradually over the specified soft-start time, when the power is switched on or when the power-off pin remains at the "H" level. This prevents the output voltage from overshooting.

However, the soft-start function of this IC is not able to perfectly prevent a rush current from flowing to the load (see Figure 5). Since this rush current depends on the input voltage and load conditions, we recommend that you evaluate it by testing performance with the actual equipment.

S-8520A33MC ($V_{IN}:0 \rightarrow 4.0$ V)

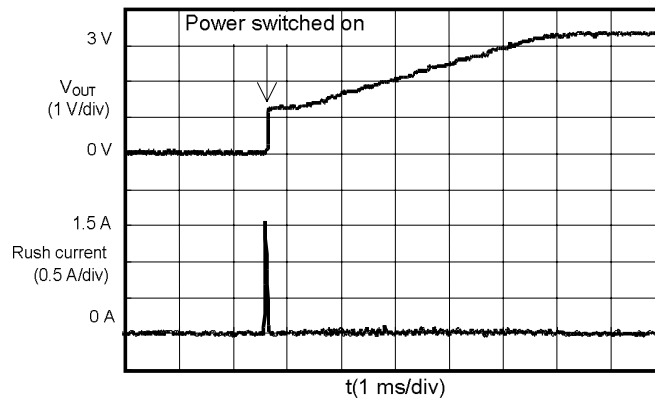

Figure 5 Waveforms of Output Voltage and Rush Current at Soft-Start

4. Overload Protection Circuit (A, C, E Series)

The S-8520/21A, S-8520/21C Series, and S-8520/21E Series come with a built-in overload protection circuit.

If the output voltage falls because of an overload, the maximum duty state (100 %) will continue. If this 100% duty state lasts longer than the prescribed overload detection time (T_{PRO}), the overload protection circuit will hold the EXT pin at "H," thereby protecting the switching transistor and inductor. When the overload protection circuit is functioning, the reference voltage circuit will be activated by means of a

soft-start in the IC, and the reference voltage will rise slowly from 0 V. The reference voltage and the feedback voltage obtained by dividing the output voltage are compared to each other. So long as the reference voltage is lower, the EXT pin will be held at "H" to keep the oscillation inactive. If the reference voltage keeps rising and exceeds the feedback voltage, the oscillation will resume.

If the load is heavy when the oscillation is restarted, and the EXT pin holds the "L" level longer than the specified overload detection time (T_{PRO}), the overload protection circuit will operate again, and the IC will enter intermittent operation mode, in which it repeats the actions described above. Once the overload state is eliminated, the IC resumes normal operation.

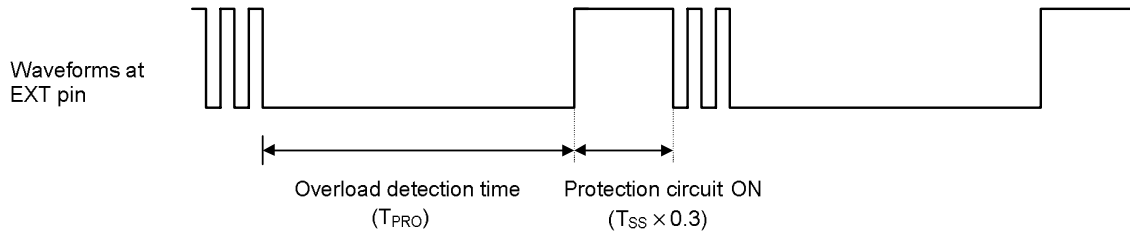

Figure 6 Waveforms Appearing at EXT Pin As the Overload Protection Circuit Operates

5. 100 % Duty Cycle

The S-8520/21 Series operates with a maximum duty cycle of 100 %. When a B, D, F Series product not provided with an overload protection circuit is used, the switching transistor can be kept ON to supply current to the load continually, even in cases where the input voltage falls below the preset output voltage value. The output voltage delivered under these circumstances is one that results from subtracting, from the input voltage, the voltage drop caused by the DC resistance of the inductance and the on-resistance of the switching transistor.

If an A, C, E Series product provided with an overload protection circuit is used, this protection circuit will function when the 100 % duty state has lasted longer than the preset overload detection time (T_{PRO}), causing the IC to enter intermittent operation mode. Under these conditions, the IC will not be able to supply current to the load continually, unlike the case described in the preceding paragraph.

■ Selection of Series Products and Associated External Components

1. Method for selecting series products

The S-8520/21 Series is classified into 12 types, according to the way the control systems (PWM and PWM/PFM-Switched), the different oscillation frequencies, and the inclusion or exclusion of an overload protection circuit are combined one with another. Please select the type that best suits your needs by taking advantage of the features of each type described below.

ⓄControl systems:

Two different control systems are available: PWM control system (S-8520 Series) and PWM/PFM-switched control system (S-8521 Series).

If particular importance is attached to the operation efficiency while the load is on standby — for example, in an application where the load current heavily varies from that in standby state as the load starts operating — a high efficiency will be obtained in standby mode by selecting the PWM/PFM-switched control system (S-8521 Series).

Moreover, for applications where switching noise poses a serious problem, the PWM control system (S-8520 Series), in which the switching frequency does not vary with the load current, is preferable because it can eliminate ripple voltages easily using a filter.

ⓄOscillation frequencies:

Three oscillation frequencies—180 kHz (A & B Series) and 60 kHz (C & D Series), 300 kHz (E, F Series)—are available.

Because of their high oscillation frequency and low-ripple voltage the A, B, E, F Series offer excellent transient response characteristics. The products in these series allow the use of small-sized inductors since the peak current remains smaller in the same load current than with products of the other series. In addition, they can also be used with small output capacitors. These outstanding features

make the A & B Series ideal products for downsizing the associated equipment.

On the other hand, the C & D Series, having a lower oscillation frequency, are characterized by a small self-consumption of current and excellent efficiency under light loads. In particular, the D Series, which employs a PWM/PFM-switched control system, enables the operation efficiency to be improved drastically when the output load current is approximately 100 μ A. (See Reference Data.)

③Overload protection circuit:

Products can be chosen either with an overload protection circuit (A, C, E Series) or without one (B, D, F Series).

Products with an overload protection circuit (A, C, E Series) enter intermittent operation mode when the overload protection circuit operates to accommodate overloads or load short-circuiting. This protects the switching elements and inductors. Nonetheless, in an application where the load needs to be fed continually with a current by taking advantage of the 100 % duty cycle state, even if the input voltage falls below the output voltage value, a B, D, F Series product will have to be used. Choose whichever product best handles the conditions of your application.

In making the selection, please keep in mind that the upper limit of the operating voltage range is either 10 V (A, C, E Series) or 16 V (B, D, F Series), depending on whether the product comes with an overload protection circuit built in.

The table below provides a rough guide for selecting a product type depending on the requirements of the application. Choose the product that gives you the largest number of circles (O).

	S-8520						S-8521					
	A	B	C	D	E	F	A	B	C	D	E	F
An overload protection circuit is required	☆		☆		☆		☆		☆		☆	
The input voltage range exceeds 10 V		☆		☆		☆		☆		☆		☆
The efficiency under light loads (load current ≤ 1 mA) is an important factor							○	○	○	○		
To be operated with a medium load current (200 mA class)	○	○			○	○			○	○		
To be operated with a high load current (1 A class)	○	○			○	○	○	○			○	○
It is important to have a low-ripple voltage	○	○			⊗	⊗	○	○			⊗	⊗
Importance is attached to the downsizing of external components	○	○			⊗	⊗	○	○			⊗	⊗

The symbol "☆" denotes an indispensable condition, while the symbol "○" indicates that the corresponding series has superiority in that aspect. The symbol "⊗" indicates particularly high superiority.

2. Inductor

The inductance value greatly affects the maximum output current I_{OUT} and the efficiency η .

As the L-value is reduced gradually, the peak current I_{pk} increases, to finally reach the maximum output current I_{OUT} when the L-value has fallen to a certain point. If the L-value is made even smaller, I_{OUT} will begin decreasing because the current drive capacity of the switching transistor becomes insufficient.

Conversely, as the L-value is augmented, the loss due to I_{pk} in the switching transistor will decrease until the efficiency is maximized at a certain L-value. If the L-value is made even larger, the loss due to the series resistance of the coil will increase to the detriment of the efficiency.

If the L-value is increased in an S-8520/21 Series product, the output voltage may turn unstable in some cases, depending on the conditions of the input voltage, output voltage, and the load current. Perform thorough evaluations under the conditions of actual service and decide on an optimum L-value.

In many applications, selecting a value of A/B/C/D Series 47 μ H, E, F Series 22 μ H will allow a S-8520/21 Series product to yield its best characteristics in a well balanced manner.

When choosing an inductor, pay attention to its allowable current, since a current applied in excess of the allowable value will cause the inductor to produce magnetic saturation, leading to a marked decline in efficiency.

Therefore, select an inductor in which the peak current I_{pk} will not surpass its allowable current at any moment. The peak current I_{pk} is represented by the following equation in continuous operation mode:

$$I_{PK} = I_{OUT} + \frac{(V_{OUT} + V_F) \times (V_{IN} - V_{OUT})}{2 \times f_{osc} \times L \times (V_{IN} + V_F)}$$

Where f_{osc} is the oscillation frequency, L the inductance value of the coil, and V_F the forward voltage of the diode.

3. Diode

The diode to be externally coupled to the IC should be a type that meets the following conditions:

- Its forward voltage is low (Schottky barrier diode recommended).
- Its switching speed is high (50 ns max.).
- Its reverse direction voltage is higher than V_{IN} .
- Its current rating is higher than I_{pk} .

4. Capacitors (C_{IN} , C_{OUT})

The capacitor inserted on the input side (C_{IN}) serves to lower the power impedance and to average the input current for better efficiency. Select the C_{IN} -value according to the impedance of the power supplied. As a rough rule of thumb, you should use a value of 47 μ F to 100 μ F, although the actual value will depend on the impedance of the power in use and the load current value.

For the output side capacitor (C_{OUT}), select one of large capacitance with low ESR (Equivalent Series Resistance) for smoothing the ripple voltage. However, notice that a capacitor with extremely low ESR (say, below 0.3 Ω), such as a ceramic capacitor, could make the output voltage unstable, depending on the input voltage and load current conditions. Instead, a tantalum electrolytic capacitor is recommended. A capacitance value from 47 μ F to 100 μ F can serve as a rough yardstick for this selection.

5. External Switching Transistor

The S-8520/21 Series can be operated with an external switching transistor of the enhancement (Pch) MOS FET type or bipolar (PNP) typ.

5.1 Enhancement MOS FET type

The EXT pin of the S-8520/21 Series is capable of directly driving a Pch power MOS FET with a gate capacity of some 1000 pF.

When a Pch power MOS FET is chosen, because it has a higher switching speed than a PNP type bipolar transistor and because power losses due to the presence of a base current are avoided, efficiency will be 2 % to 3 % higher than when other types of transistor are employed.

The important parameters to be kept in mind in selecting a Pch power MOS FET include the threshold voltage, breakdown voltage between gate and source, breakdown voltage between drain and source, total gate capacity, on-resistance, and the current rating.

The EXT pin swings from voltage V_{IN} over to voltage V_{SS} . If the input voltage is low, a MOS FET with a low threshold voltage has to be used so that the MOS FET will come on as required. If, conversely, the input voltage is high, select a MOS FET whose gate-source breakdown voltage is higher than the input voltage by at least several volts.

Immediately after the power is turned on, or when the power is turned off (that is, when the step-down operation is terminated), the input voltage will be imposed across the drain and the source of the MOS FET. Therefore, the transistor needs to have a drain-source breakdown voltage that is also several volts higher than the input voltage.

The total gate capacity and the on-resistance affect the efficiency.

The power loss for charging and discharging the gate capacity by switching operation will increase, when the total gate capacity becomes larger and the input voltage rises higher. Therefore the gate capacity affects the efficiency of power in a low load current region. If the efficiency under light loads is a matter of particular concern, select a MOS FET with a small total gate capacity.

In regions where the load current is high, the efficiency is affected by power losses caused due to the on-resistance of the MOS FET. Therefore, if the efficiency under heavy loads is particularly important for

your application, choose a MOS FET with as low an on-resistance as possible.

As for the current rating, select a MOS FET whose maximum continuous drain current rating is higher than the peak current I_{pk} .

For reference purpose, some efficiency data has been included in this document. For applications with an input voltage range of 10 V or less, data was obtained by using TM6201 of Toyoda Automatic Loom Works, Ltd. IRF7606, a standard of International Rectifier, was used for applications with an input voltage range over 10 V. Refer to "Reference Data."

5.2 Bipolar PNP type

Figure 7 shows a sample circuit diagram using Toshiba 2SA1213-Y for the bipolar transistor (PNP). The driving capacity for increasing the output current by means of a bipolar transistor is determined by the h_{FE} -value and the R_b -value of that bipolar transistor.

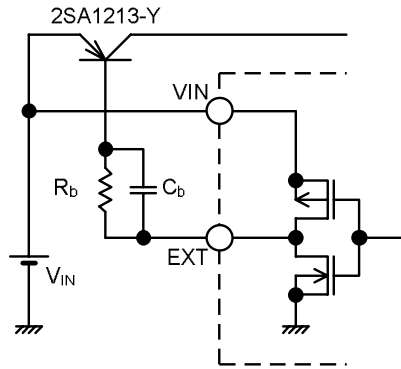

Figure 7

The R_b -value is given by the following equation:

$$R_b = \frac{V_{IN} - 0.7}{I_b} - \frac{0.4}{|I_{EXTL}|}$$

Find the necessary base current I_b using the h_{FE} - value of bipolar transistor by the equation, $I_b = I_{pk}/h_{FE}$, and select a smaller R_b -value.

A small R_b -value will certainly contribute to increasing the output current, but it will also adversely affect the efficiency. Moreover, in practice, a current may flow as the pulses or a voltage drop may take place due to the wiring resistance or some other reason. Determine an optimum value through experimentation.

In addition, if speed-up capacitor C_b is inserted in parallel with resistance R_b , as shown in Figure 7, the switching loss will be reduced, leading to a higher efficiency.

Select a C_b -value by using the following equation as a guide:

$$C_b \leq \frac{1}{2\pi \times R_b \times f_{OSC} \times 0.7}$$

However, the practically-reasonable C_b value differs depending upon the characteristics of the bipolar transistor. Optimize the C_b value based on the experiment result.

■ Standard Circuits:

(1) Using a bipolar transistor:

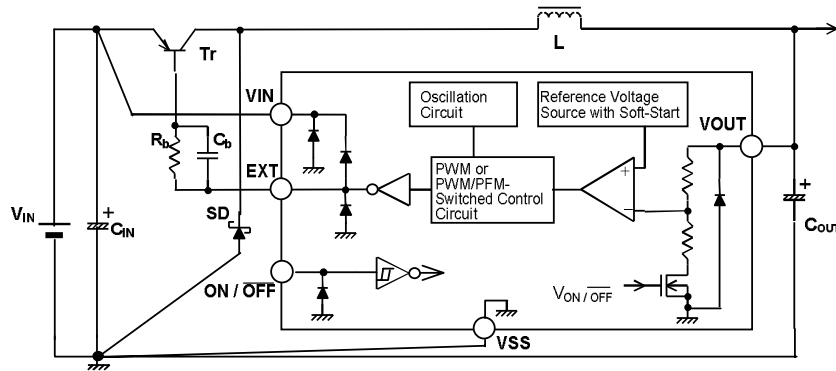

Figure 8

(2) Using a Pch MOS-FET transistor

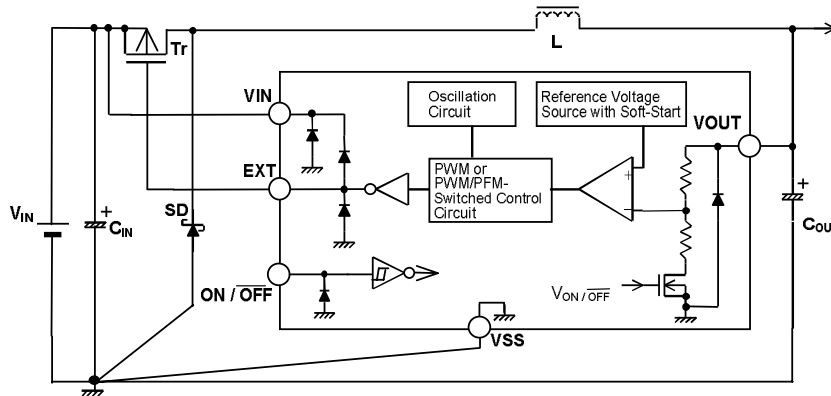

Figure 9

■ Precautions:

- Install the external capacitors, diode, coil, and other peripheral components as close to the IC as possible, and secure grounding at a single location.
- Any switching regulator intrinsically produces a ripple voltage and spike noise, which are largely dictated by the coil and capacitors in use. When designing a circuit, first test them on actual equipment.
- The overload protection circuit of this IC performs the protective function by detecting the maximum duty time (100%). In choosing the components, make sure that overcurrents generated by short-circuits in the load, etc., will not surpass the allowable dissipation of the switching transistor and inductor.
- Make sure that dissipation of the switching transistor will not surpass the allowable dissipation of the package. (especially at the time of high temperature)

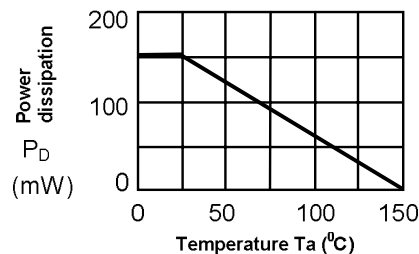

Figure 10 Power dissipation of an SOT-23-5 Package (Free-Air)

- Do not apply an electrostatic discharge to this IC that exceeds the performance ratings of the built-in electrostatic protection circuit.
- Seiko Instruments Inc. shall not be responsible for any patent infringement by products including the S-8520/8521 Series in connection with the method of using the S-8520/8521 Series in such products, the product specifications or the country of destination thereof.

■ **Application Circuits:**

1. **External adjustment of output voltage**

The S-8520/21 Series allows you to adjust the output voltage or to set the output voltage to a value over the preset output voltage range (6 V) of the products of this series, when external resistances R_A , R_B , and capacitor C_C are added, as illustrated in Figure 11. Moreover, a temperature gradient can be obtained by inserting a thermistor or other element in series with R_A and R_B .

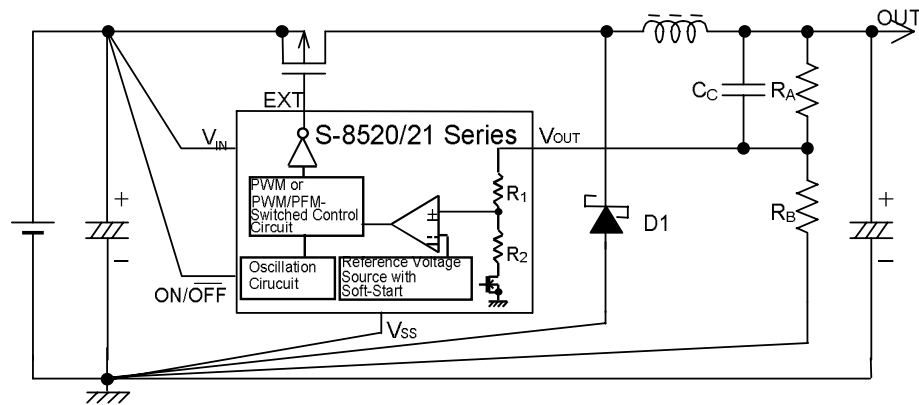

Figure 11

The S-8520 and 21 Series have an internal impedance of R_1 and R_2 between the V_{OUT} and the V_{SS} pin, as shown in Figure 11.

Therefore, the output voltage (OUT) is determined by the output voltage value V_{OUT} of the S-8520/21 Series, and the ratio of the parallel resistance value of external resistance R_B and internal resistances $R_1 + R_2$ of the IC, to external resistance R_A . The output voltage is expressed by the following equation:

$$OUT = V_{OUT} + V_{OUT} \times R_A \div (R_B // (R_1 + R_2)) \quad (\text{Note: } // \text{ denotes a combined resistance in parallel.})$$

The voltage accuracy of the output OUT set by resistances R_A and R_B is not only affected by the IC's output voltage accuracy ($V_{OUT} \pm 2.4\%$), but also by the absolute precision of external resistances R_A and R_B in use and the absolute value deviations of internal resistances R_1 and R_2 in the IC.

Let us designate the maximum deviations of the absolute value of external resistances R_A and R_B by R_{Amax} and R_{Bmax} , respectively, the minimum deviations by R_{Amin} and R_{Bmin} , respectively, and the maximum and minimum deviations of the absolute value of internal resistances R_1 and R_2 in the IC by $(R_1+R_2)_{max}$ and $(R_1+R_2)_{min}$, respectively. Then, the minimum deviation value OUT_{min} and the maximum deviation value OUT_{max} of the output voltage OUT are expressed by the following equations:

$$OUT_{min} = V_{OUT} \times 0.976 + V_{OUT} \times 0.976 \times R_{Amin} \div (R_{Bmax} // (R_1 + R_2)_{max})$$

$$OUT_{max} = V_{OUT} \times 1.024 + V_{OUT} \times 1.024 \times R_{Amax} \div (R_{Bmin} // (R_1 + R_2)_{min})$$

The voltage accuracy of the output OUT cannot be made higher than the output voltage accuracy ($V_{OUT} \pm 2.4\%$) of the IC itself, without adjusting the external resistances R_A and R_B involved. The closer the voltage value of the output OUT and the output voltage value (V_{OUT}) of the IC are brought to one other, the more the output voltage remains immune to deviations in the absolute accuracy of externally connected resistances R_A and R_B and the absolute value of internal resistances R_1 and R_2 in the IC.

In particular, to suppress the influence of deviations in internal resistances R_1 and R_2 in the IC, a major contributor to deviations in the output OUT, the external resistances R_A and R_B must be limited to a much smaller value than that of internal resistances R_1 and R_2 in the IC.

On the other hand, a reactive current flows through external resistances R_A and R_B . This reactive current must be reduced to a negligible value with respect to the load current in the actual use of the IC so that the efficiency characteristics will not be degraded. This requires that the value of external resistance R_A and R_B be made sufficiently large.

However, too large a value (more than 1 M Ω) for the external resistances R_A and R_B would make the IC vulnerable to external noise. Check the influence of this value on actual equipment.

There is a tradeoff between the voltage accuracy of the output OUT and the reactive current. This should be taken into consideration based on the requirements of the intended application.

Deviations in the absolute value of internal resistances R_1 and R_2 in the IC vary with the output voltage of the S-8520/21 Series, and are broadly classified as follows:

- Output voltage 1.5 V to 2.0 V \rightarrow 5.16 M Ω to 28.9 M Ω
- Output voltage 2.1 V to 2.5 V \rightarrow 4.44 M Ω to 27.0 M Ω
- Output voltage 2.6 V to 3.3 V \rightarrow 3.60 M Ω to 23.3 M Ω
- Output voltage 3.4 V to 4.9 V \rightarrow 2.44 M Ω to 19.5 M Ω
- Output voltage 5.0 V to 6.0 V \rightarrow 2.45 M Ω to 15.6 M Ω

When a value of R_1+R_2 given by the equation indicated below is taken in calculating the voltage value of the output OUT, a median voltage deviation will be obtained for the output OUT.

$R_1 + R_2 = 2 \div (1 \div \text{maximum deviation in absolute value of internal resistances } R_1 \text{ and } R_2 \text{ in IC} + 1 \div \text{minimum deviation in absolute value of internal resistances } R_1 \text{ and } R_2 \text{ of IC})$

Moreover, add a capacitor C_C in parallel to the external resistance R_A in order to avoid output oscillations and other types of instability (See Figure 11).

Make sure that C_C is larger than the value given by the following equation:

$$C_C (\text{F}) \geq 1 \div (2 \times \pi \times R_A (\Omega) \times 7.5 \text{ kHz})$$

If a large C_C -value is selected, a longer soft-start time than the one set up in the IC will be set.

- SII is equipped with a tool that allows you to automatically calculate the necessary resistance values of R_A and R_B from the required voltage accuracy of the output OUT. SII will be pleased to assist its customers in determining the R_A and R_B values. Should such assistance be desired, please inquire.
- Moreover, SII also has ample information on which peripheral components are suitable for use with this IC and data concerning the deviations in the IC's characteristics. We are ready to help our customers with the design of application circuits.
Please contact the **SII Components Sales Dept.**

■ Characteristics of Major Parameters (Typical values):

(1)

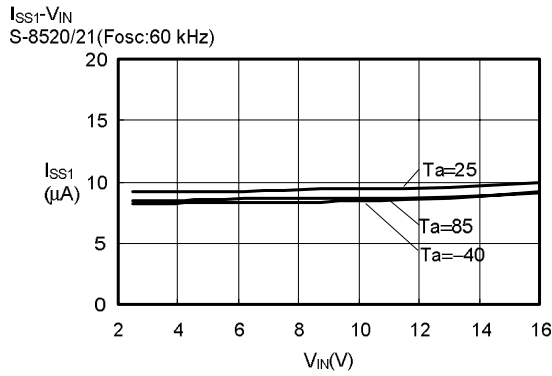

(2)

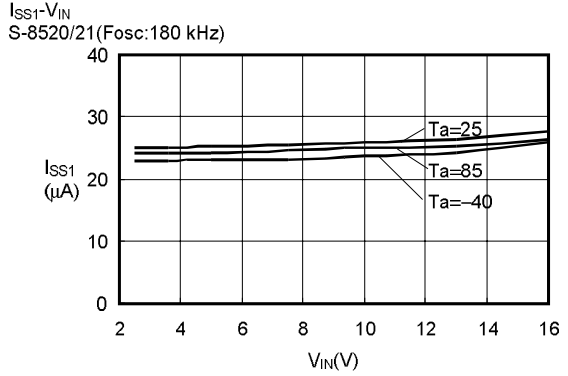

(3)

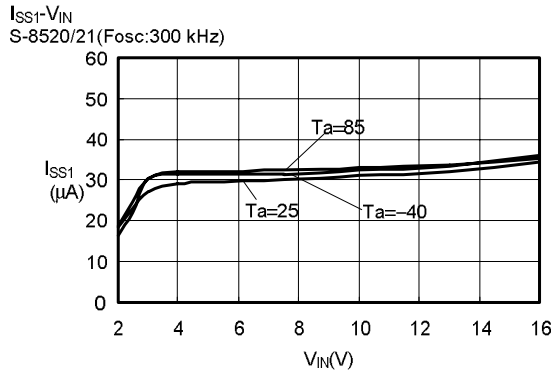

(4)

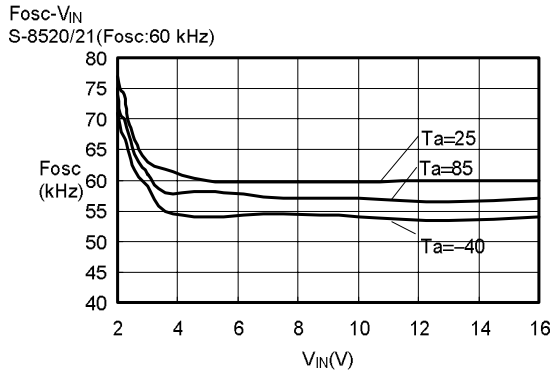

(5)

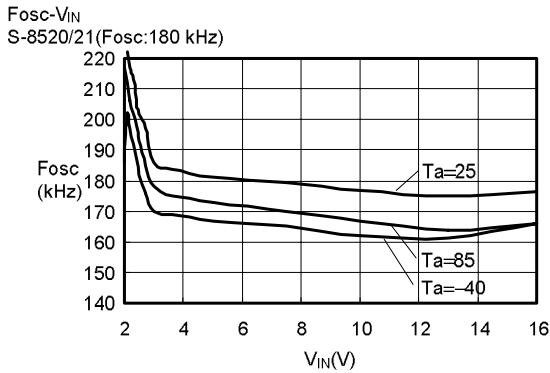

(6)

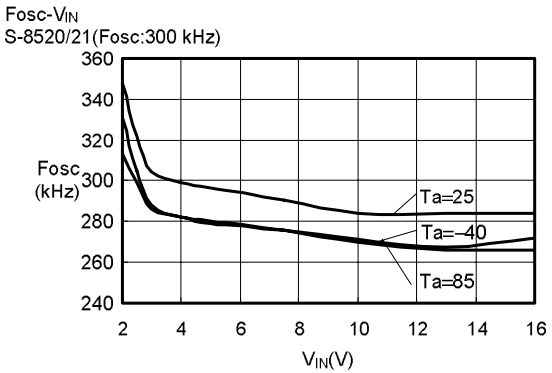

(7)

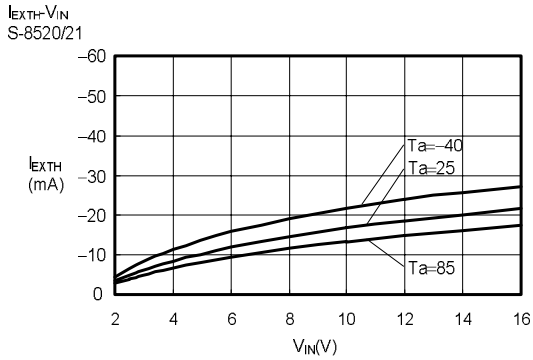

(8)

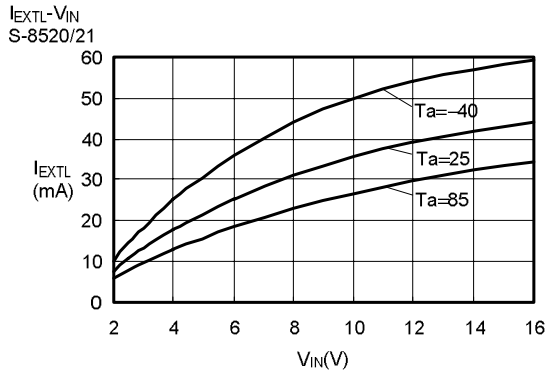

(9)

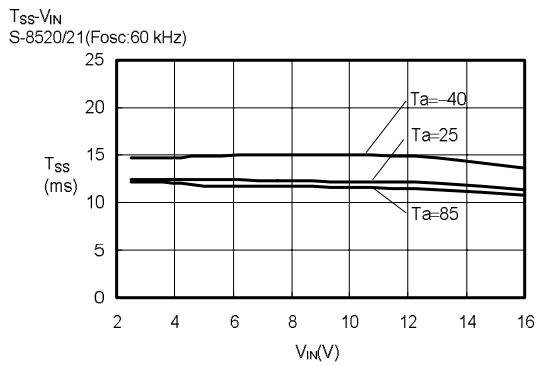

(10)

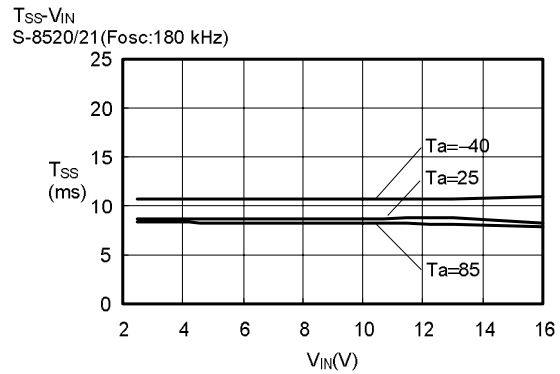

(11)

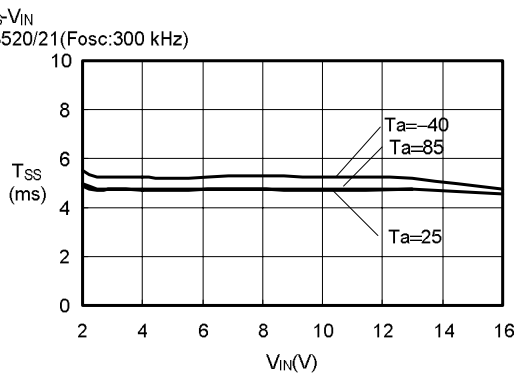

(12)

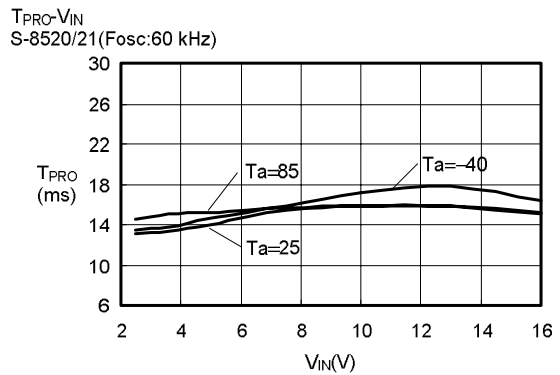

(13)

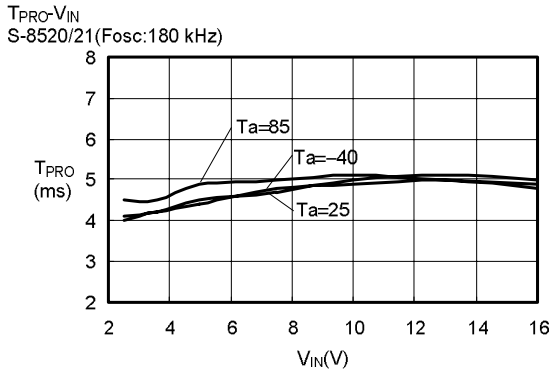

(14)

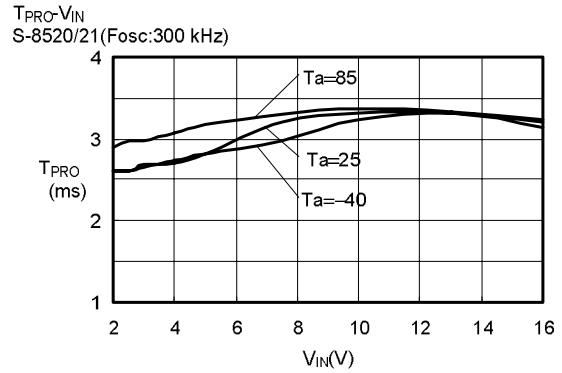

(15)

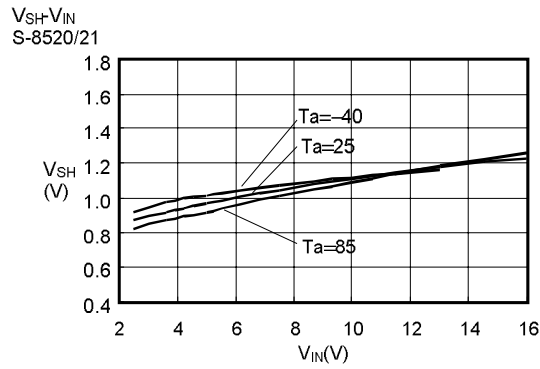

(16)

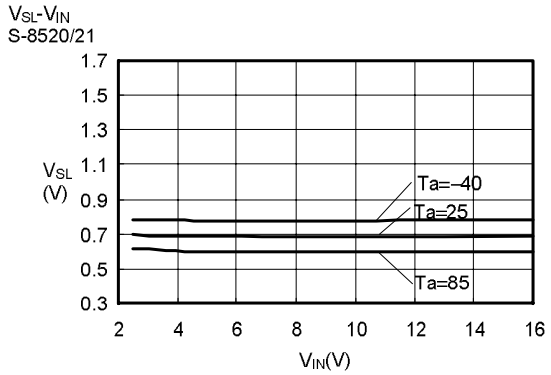

(17)

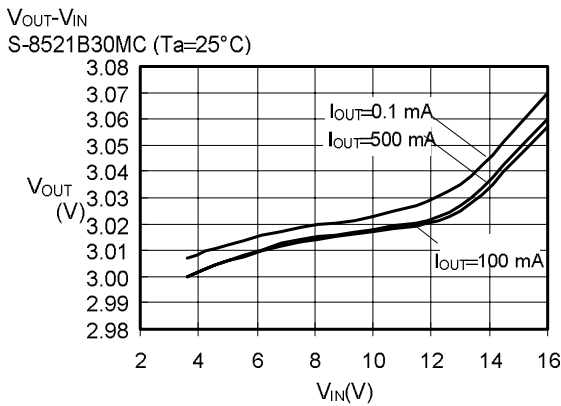

(18)

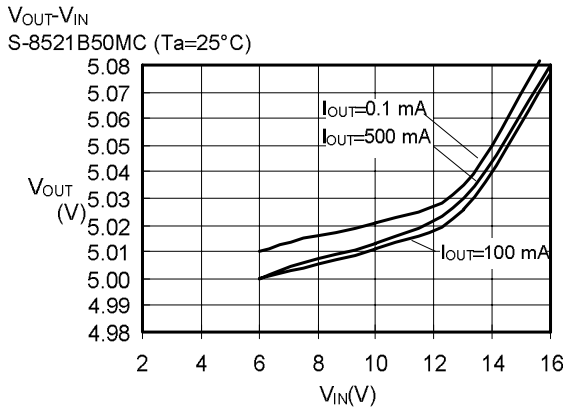

(19)

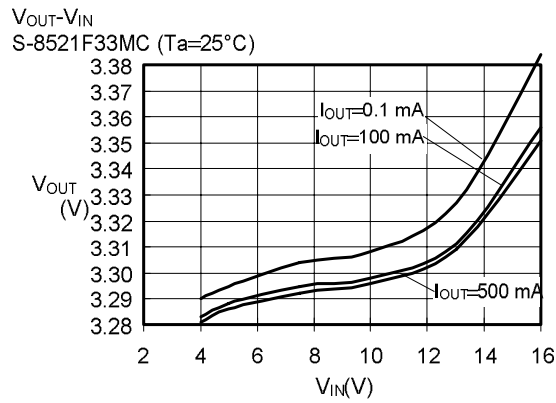

(20)

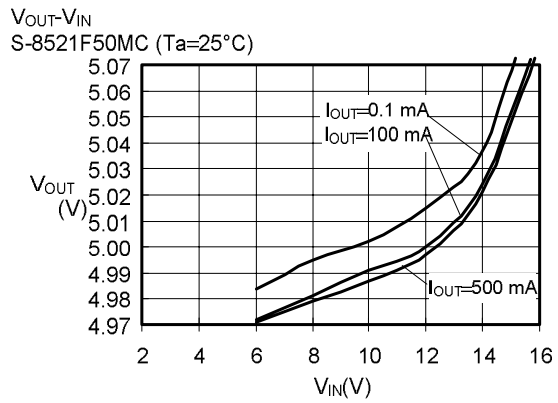

■ **Transient Response Characteristics:**

1. **Power-On (V_{IN} : 0 V→3.6 V or 4.0 V, 0 V→9.0 V I_{OUT} : No-load)**

S-8520/1C30MC (V_{IN} : 0 →3.6 V)

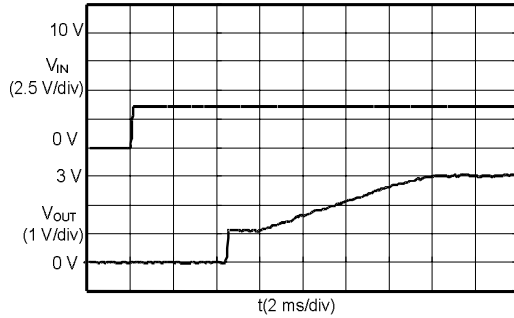

S-8520/1C30MC (V_{IN} : 0 →9.0 V)

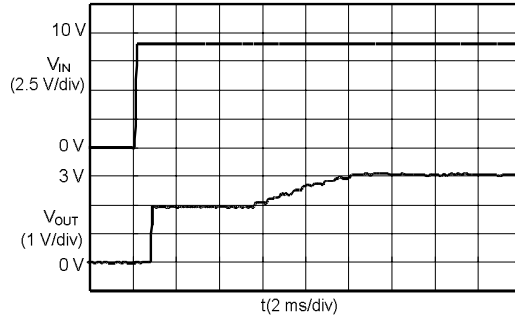

S-8520/1A30MC (V_{IN} : 0 →3.6 V)

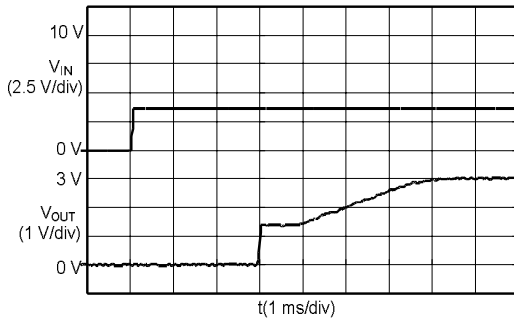

S-8520/1A30MC (V_{IN} : 0 →9.0 V)

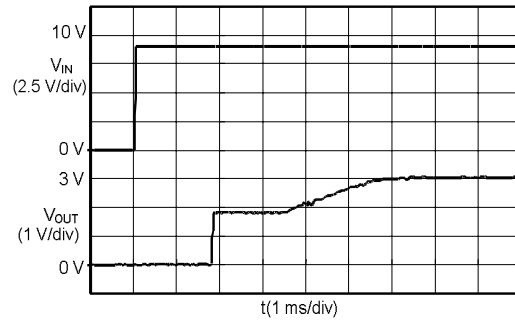

S-8520/1E33MC (V_{IN} : 0 →4.0 V)

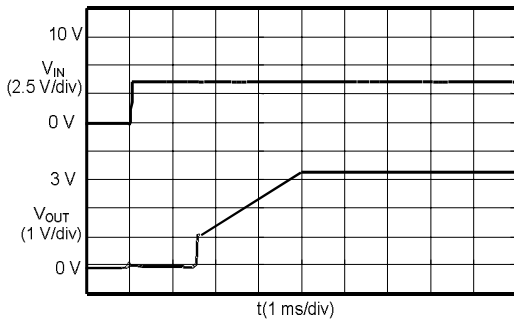

S-8520/1E33MC (V_{IN} : 0 →9.0 V)

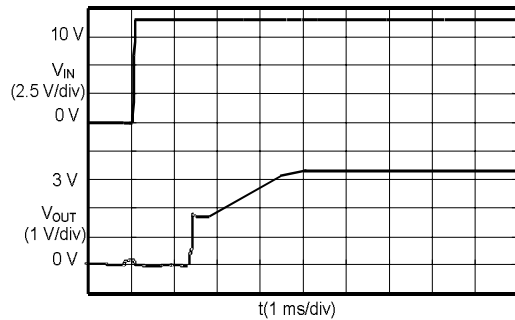

2. Power-Off Terminal Response ($V_{ON/OFF}$: 0 V→1.8 V I_{OUT} : No-load)

S-8520/1C30MC (V_{IN} :3.6 V)

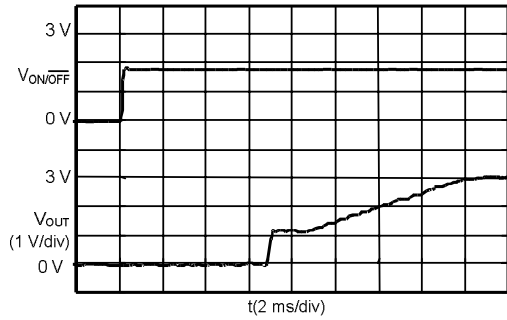

S-8520/1C30MC (V_{IN} :9.0 V)

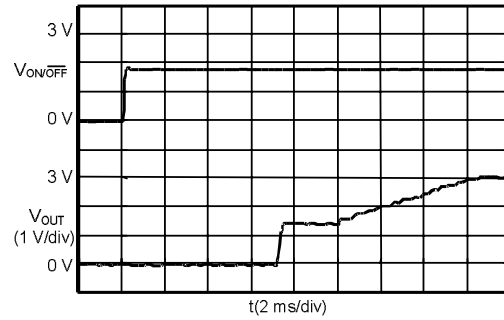

S-8520/1A30MC (V_{IN} :3.6 V)

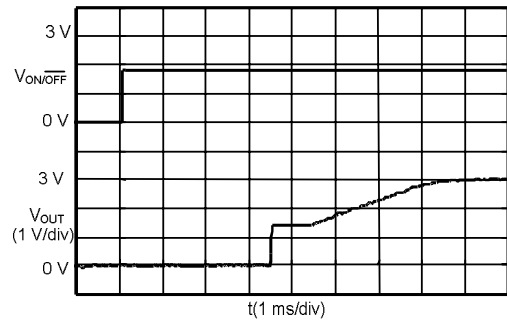

S-8520/1A30MC (V_{IN} :9.0 V)

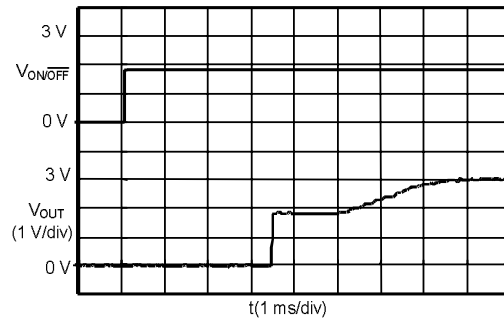

S-8520/1E33MC (V_{IN} :4.0 V)

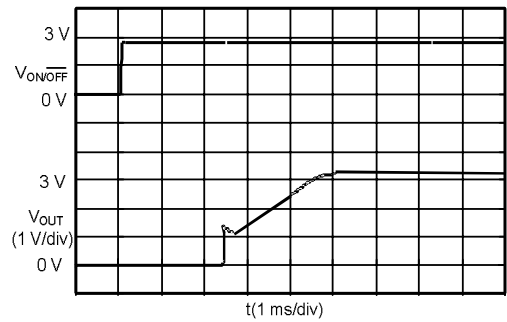

S-8520/1E33MC (V_{IN} :9.0 V)

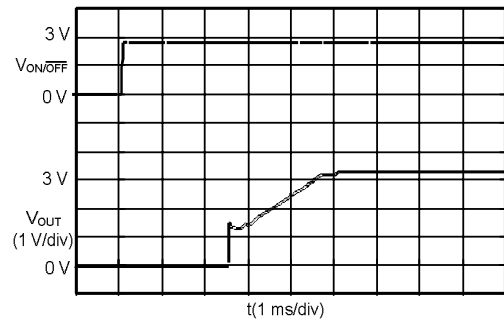

3. Supply Voltage Variation (V_{IN} : 4 V→9 V, 9 V→4 V)

S-8520/1C33MC (I_{OUT} :10 mA)

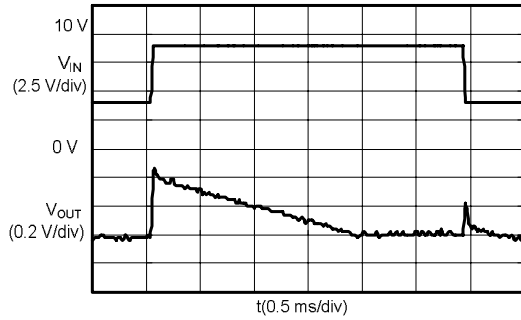

S-8520/1C33MC (I_{OUT} :500 mA)

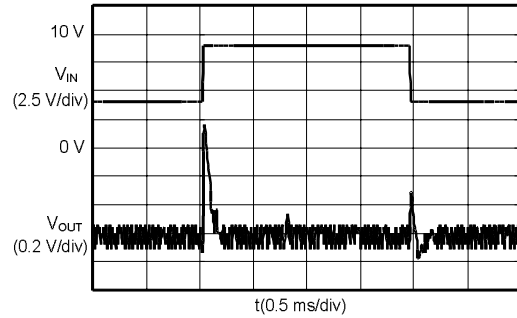

S-8520/1A30MC (I_{OUT} :10 mA)

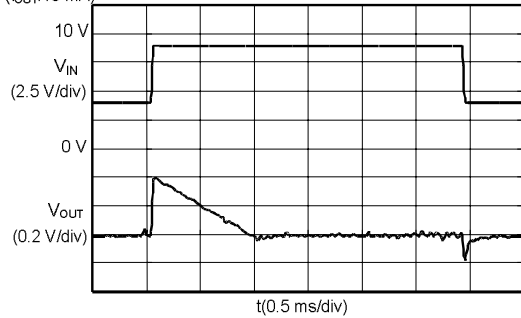

S-8520/1A30MC (I_{OUT} :500 mA)

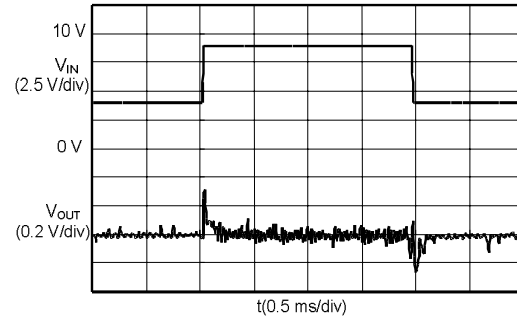

S-8520/1E33MC (I_{OUT} :10 mA)

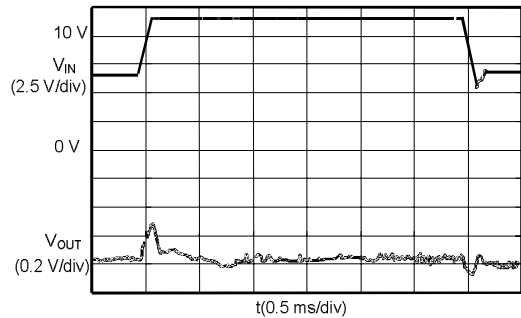

S-8520/1E33MC (I_{OUT} :500 mA)

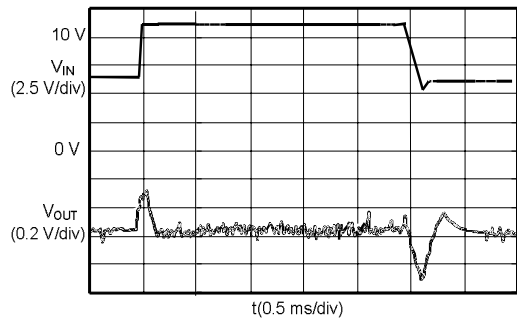

4. Load Variation (V_{IN} : 3.6V or 4.0V I_{OUT} : 0.1mA→500mA, 500mA→0.1mA)

S-8520/1C30MC (V_{IN} :3.6 V)

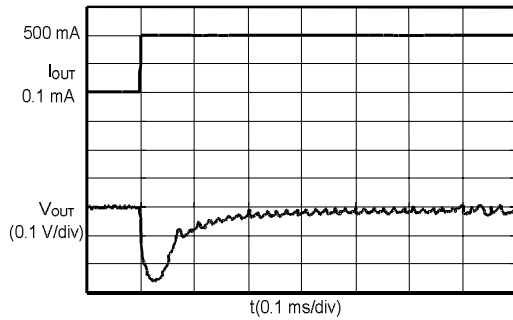

S-8520/1C30MC (V_{IN} :3.6 V)

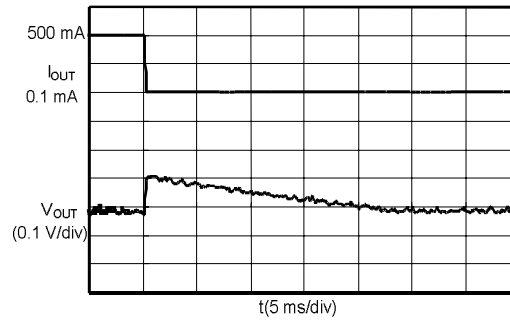

S-8520/1A30MC (V_{IN} :3.6 V)

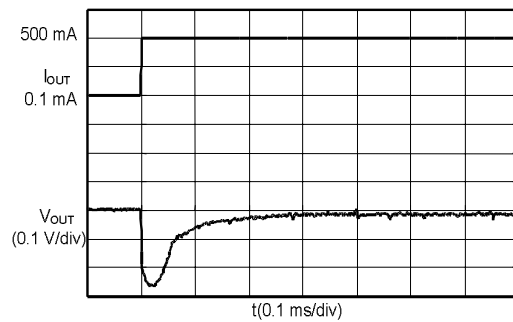

S-8520/1A30MC (V_{IN} :3.6 V)

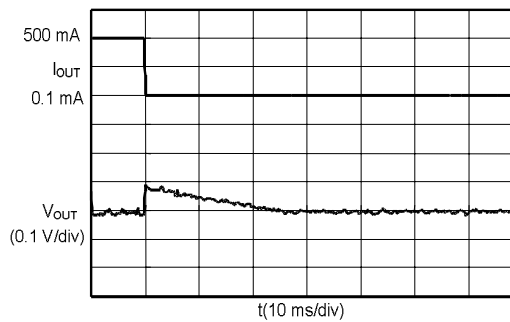

S-8520/1E33MC (V_{IN} :4.0 V)

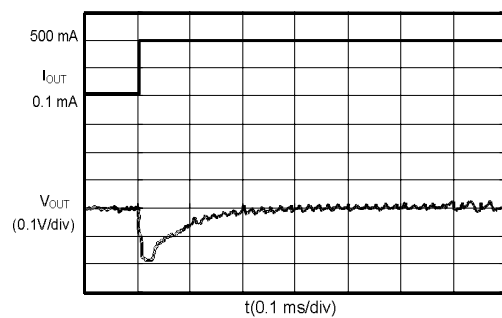

S-8520/1E33MC (V_{IN} :4.0 V)

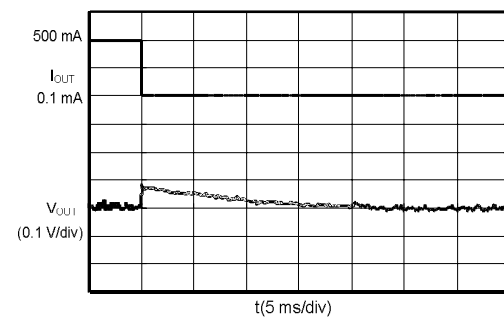

■ **External Parts Reference Data:**

This reference data is intended to help you select peripheral components to be externally connected to the IC. Therefore, this information provides recommendations on external components selected with a view to accommodating a wide variety of IC applications. Characteristic data is duly indicated in the table below.

Table 1 Efficiency Data

No.	Product Name	Output Voltage (V)	Inductor	Transistor	Diode	Output Capacitor (μF)	Application
(1)	S-8520B30MC	3.0	CD105/47 μH	TM6201	MA737	47	$I_{OUT} \leq 1$ A, $V_{IN} \leq 10$ V
(2)	S-8520F33MC	3.3	D62F/22 μH	↑	MA720	22	$I_{OUT} \leq 0.5$ A, $V_{IN} \leq 10$ V
(3)	↑	↑	CDH113/22 μH	IRF7606	MA737	↑	$I_{OUT} \leq 1$ A, $V_{IN} \leq 16$ V
(4)	S-8521D30MC	3.0	CD54/47 μF	TM6201	MA720	47×2	$I_{OUT} \leq 0.5$ A, $V_{IN} \leq 10$ V Equipment standby mode involved.
(5)	↑	↑	↑	IRF7606	↑	↑	$I_{OUT} \leq 0.5$ A, $V_{IN} \leq 16$ V Equipment standby mode involved.
(6)	S-8521B30MC	↑	CD105/47 μF	TM6201	MA737	47	$I_{OUT} \leq 1$ A, $V_{IN} \leq 10$ V Equipment standby mode involved.
(7)	↑	↑	↑	IRF7606	↑	↑	$I_{OUT} \leq 1$ A, $V_{IN} \leq 16$ V Equipment standby mode involved.
(8)	S-8521F33MC	3.3	D62F/22 μH	TM6201	MA720	22	$I_{OUT} \leq 0.5$ A, $V_{IN} \leq 10$ V Equipment standby mode involved.
(9)	↑	↑	CDH113/22 μH	IRF7606	MA737	↑	$I_{OUT} \leq 1$ A, $V_{IN} \leq 16$ V Equipment standby mode involved.
(10)	S-8520B50MC	5.0	CD54/47 μF	TM6201	MA720	47	$I_{OUT} \leq 0.5$ A, $V_{IN} \leq 10$ V
(11)	↑	↑	CD105/47 μF	IRF7606	MA737	↑	$I_{OUT} \leq 1$ A, $V_{IN} \leq 16$ V
(12)	S-8520F50MC	↑	D62F/22 μH	TM6201	MA720	22	$I_{OUT} \leq 0.5$ A, $V_{IN} \leq 10$ V
(13)	↑	↑	CDH113/22 μH	IRF7606	MA737	↑	$I_{OUT} \leq 1$ A, $V_{IN} \leq 16$ V
(14)	S-8521D50MC	↑	CD54/47 μF	TM6201	MA720	47×2	$I_{OUT} \leq 0.5$ A, $V_{IN} \leq 10$ V Equipment standby mode involved.
(15)	↑	↑	CD105/47 μF	IRF7606	MA737	↑	$I_{OUT} \leq 1$ A, $V_{IN} \leq 16$ V Equipment standby mode involved.
(16)	S-8521B50MC	↑	CD54/47 μF	TM6201	MA720	47	$I_{OUT} \leq 0.5$ A, $V_{IN} \leq 10$ V Equipment standby mode involved.
(17)	↑	↑	CD105/47 μF	IRF7606	MA737	↑	$I_{OUT} \leq 1$ A, $V_{IN} \leq 16$ V Equipment standby mode involved.
(18)	S-8521F50MC	↑	D62F/22 μH	TM6201	MA720	22	$I_{OUT} \leq 0.5$ A, $V_{IN} \leq 10$ V Equipment standby mode involved.
(19)	↑	↑	CDH113/22 μH	IRF7606	MA737	↑	$I_{OUT} \leq 1$ A, $V_{IN} \leq 16$ V Equipment standby mode involved.

Table 2 Ripple Data

No.	Product Name	Output Voltage (V)	Inductor (μH)	Transistor	Rb (Ω)	Cb (pF)	Diode	Output Capacitor (μF)
(20)	S-8520D30MC	3.0	CD105/47	2SA1213Y	680	2200	MA720	47 \times 2
(21)	S-8521D30MC	↑	↑	↑	↑	↑	↑	↑
(22)	S-8520B30MC	↑	↑	↑	↑	↑	↑	22 \times 2
(23)	S-8521B30MC	↑	↑	↑	↑	↑	↑	↑
(24)	S-8520F33MC	3.3	CDH113/22	IRF7606	–	–	MA737	22
(25)	S-8521F33MC	↑	↑	↑	–	–	↑	↑
(26)	S-8520D50MC	5.0	CD105/47	2SA1213Y	680	2200	MA720	47 \times 2
(27)	S-8521D50MC	↑	↑	↑	↑	↑	↑	↑
(28)	S-8520B50MC	↑	↑	↑	↑	↑	↑	22 \times 2
(29)	S-8521B50MC	↑	↑	↑	↑	↑	↑	↑
(30)	S-8520F50MC	↑	CDH113/22	IRF7606	–	–	MA737	22
(31)	S-8521F50MC	↑	↑	↑	–	–	↑	↑

Table 3 Performance Data

Component	Product Name	Manufacturer's Name	L-Value (μH)	DC Resistance (Ω)	Max. Allowable Current (A)	Dia. (mm)	Height (mm)
Inductor	CD54	Sumida Electric Co., Ltd	47	0.37	0.72	5.8	4.5
	CD105	↑	↑	0.17	1.28	10.0	5.4
	CDH113	↑	22	0.09	1.44	11.0	3.7
	D62F	Toko	↑	0.25	0.70	6.0	2.7
Diode	MA720	Matsushita Electronics Corporation	Forward current 500 mA (When $V_F = 0.55$ V)				
	MA737	↑	Forward current 1.5 A (When $V_F = 0.5$ V)				
Output Capacity	F93	Nichicon					
	TE	Matsushita Electronics Corporation					
External Transistor (Bipolar PNP)	2SA1213Y	Toshiba Corporation	V_{CE0} 50 V max., I_C -2 A max., h_{FE} 120 to 240 SOT-89-3 PKG				
External Transistor (MOS FET)	TM6201	Toyota Automatic Loom Works, Ltd.	V_{GS} 12 V max., I_D -2 A max., V_{th} -0.7 V min., C_{iss} 320 pF typ. R_{on} 0.25 Ω max. ($V_{GS} = -4.5$ V), SOT-89-3 PKG				
	IRF7606	International Rectifier	V_{GS} 20 V max., I_D -2.4 A max., V_{th} -1 V min. C_{iss} 470 pF typ. R_{on} 0.15 Ω max. ($V_{GS} = -4.5$ V), Micro 8 PKG				

1. Efficiency Characteristics

(1)

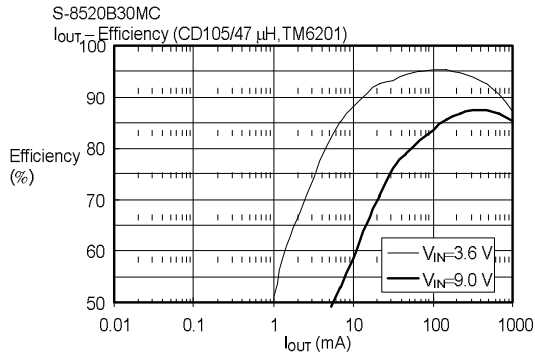

(2)

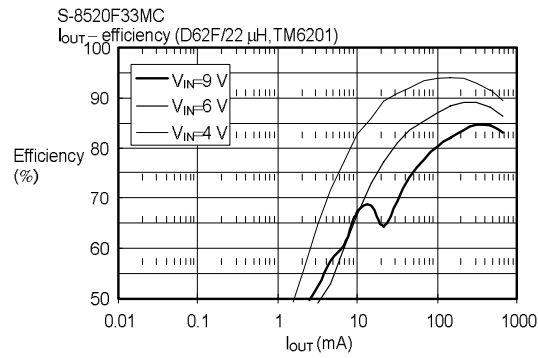

(3)

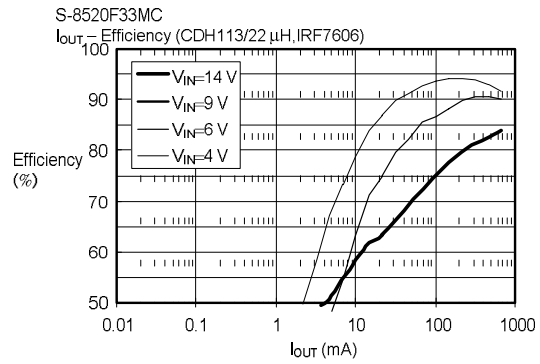

(4)

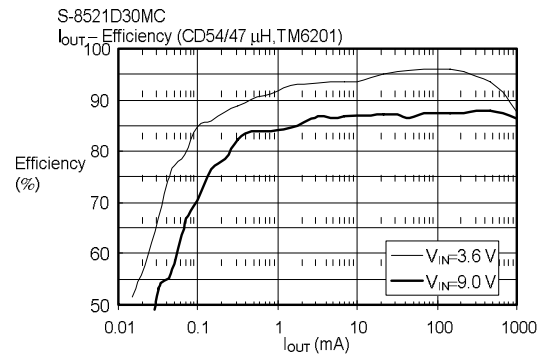

(5)

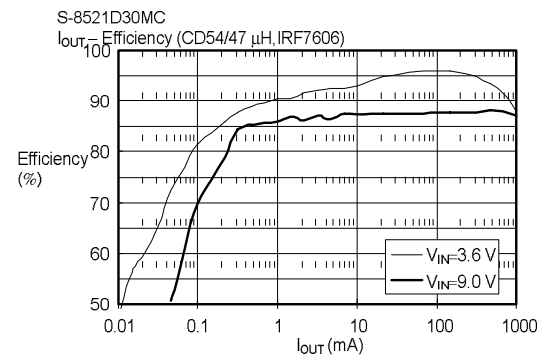

(6)

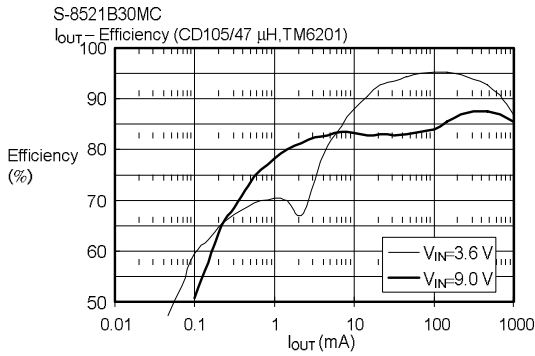

(7)

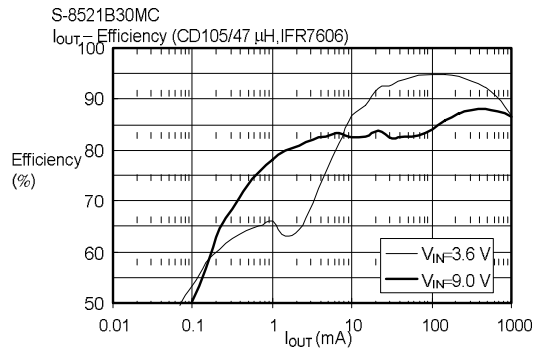

(8)

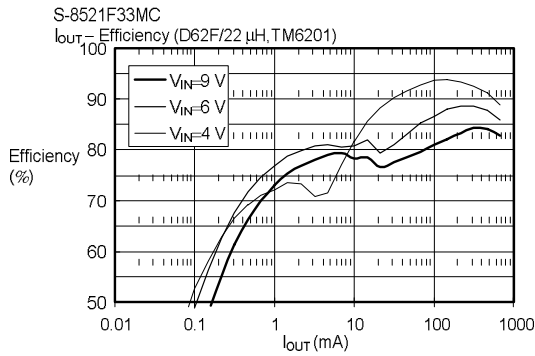

(9)

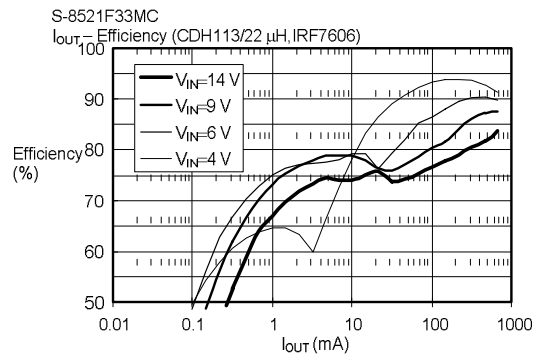

(10)

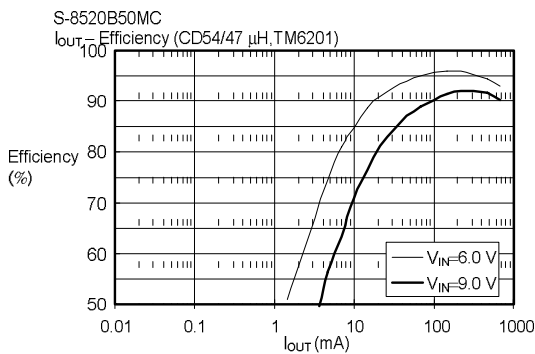

(11)

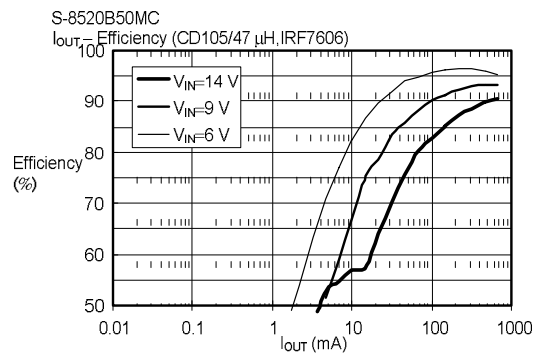

(12)

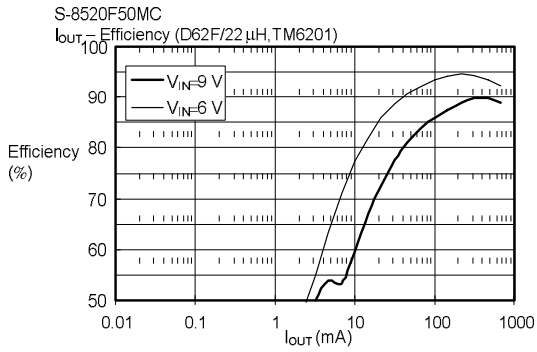

(13)

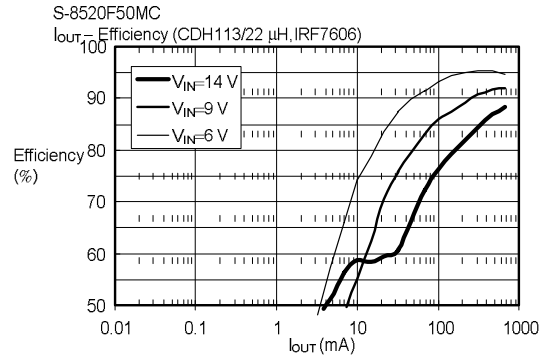

(14)

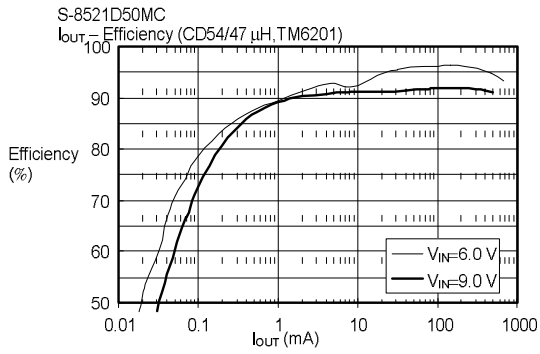

(15)

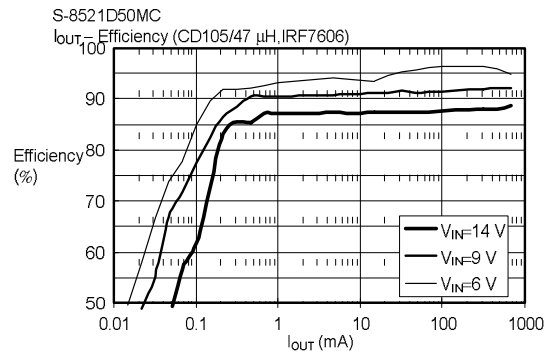

(16)

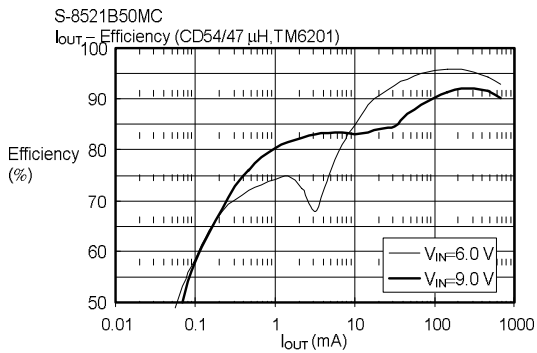

(17)

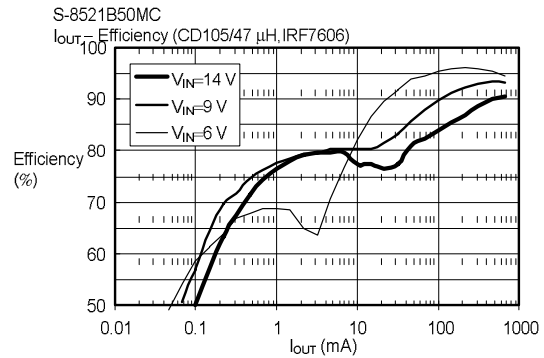

(18)

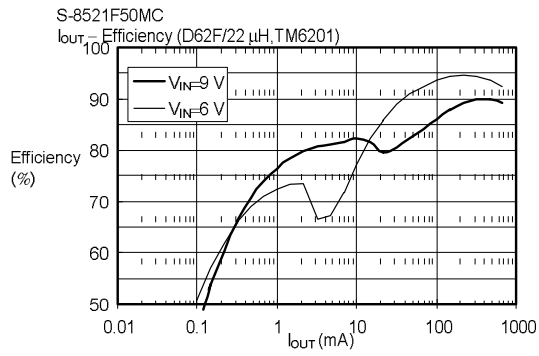

(19)

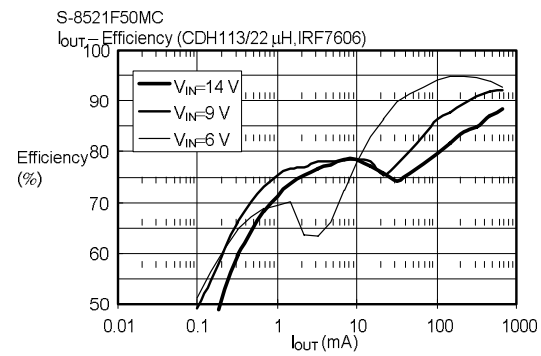

2. Ripple Voltage Characteristics(L:CD105/47 μ F, Tr:2SA1213, SBD:MA720)

(20)

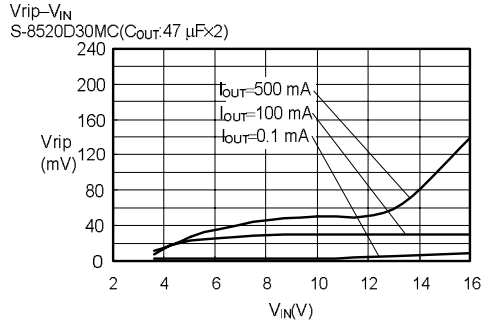

(21)

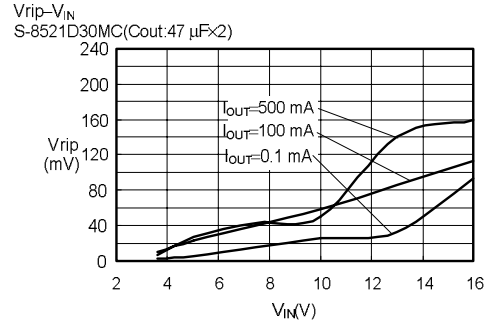

(22)

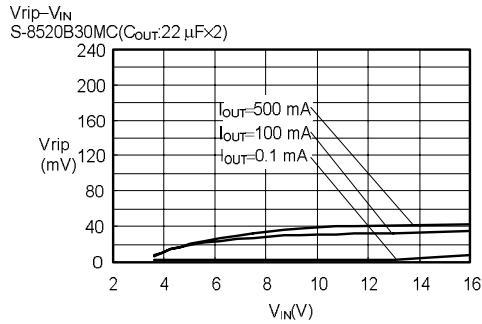

(23)

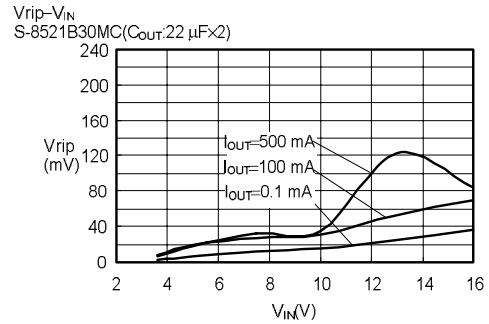

(24)

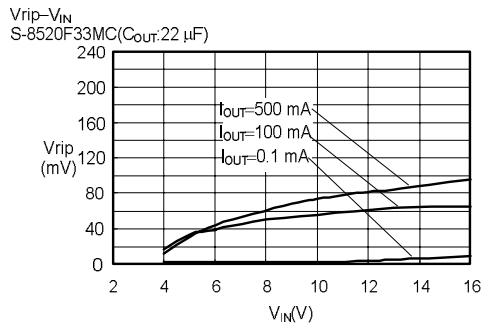

(25)

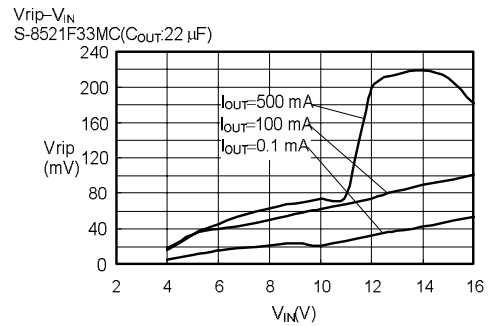

PWM Control & PWM/PFM Control Step-Down Switching Regulator-Controllers

S-8520/8521 Series

Rev.7.4 10

(26)

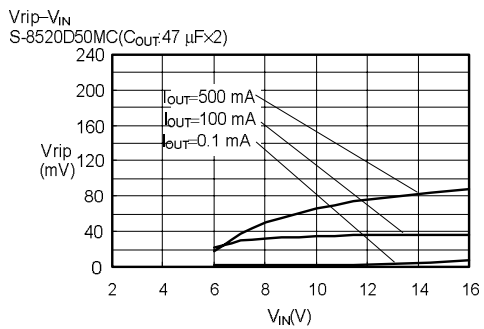

(27)

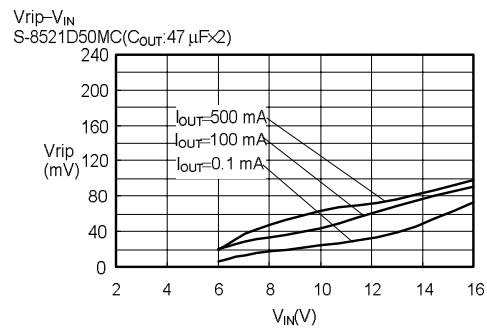

(28)

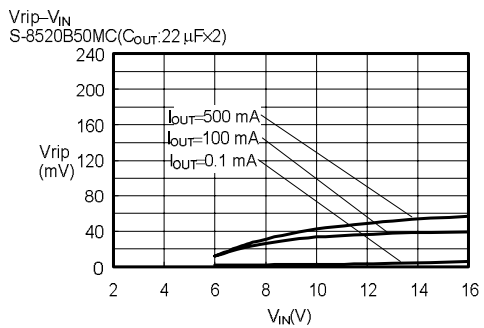

(29)

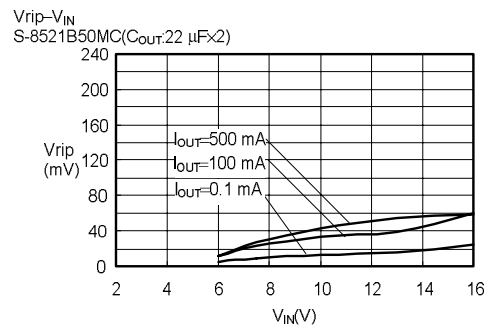

(30)

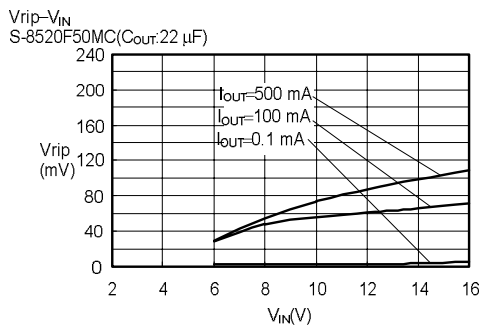

(31)

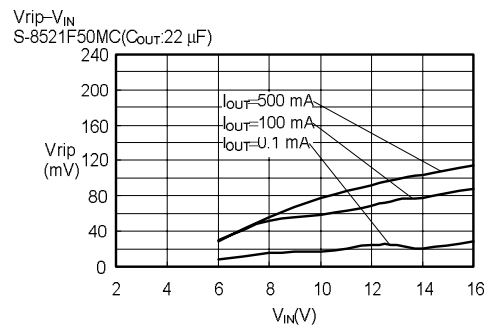

3. PWM/PFM

(5)

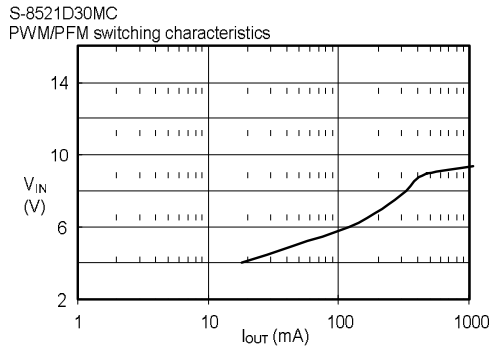

(7)

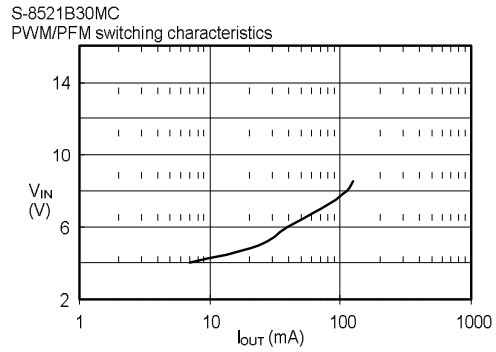

(9)

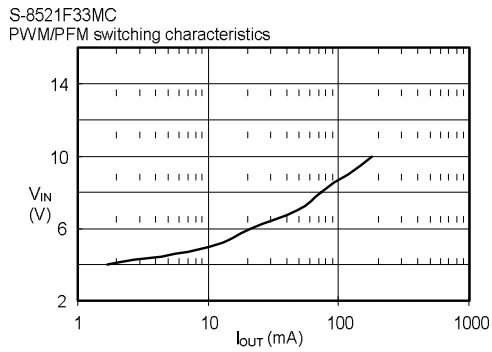

(15)

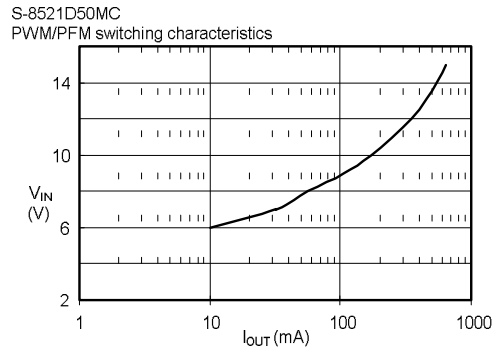

(17)

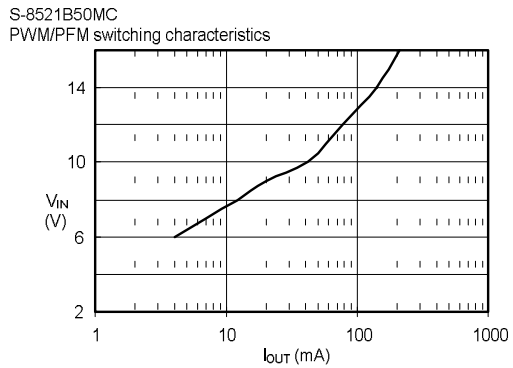

(19)

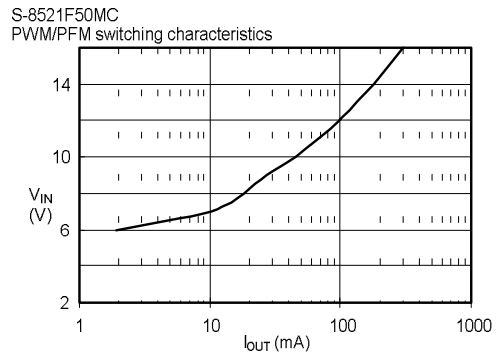

■ SOT-23-5

MP005-A

010907

● Dimensions

Unit : mm

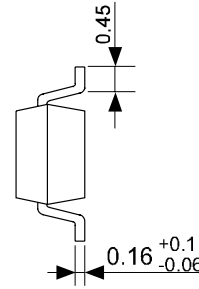
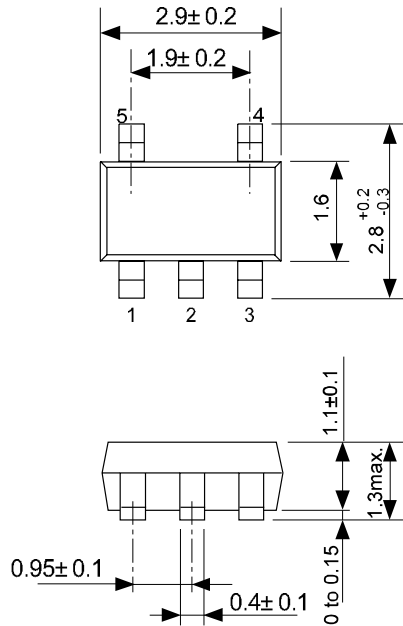

No. MP005-A-P-SD-1.1

● Tape Specifications

● Reel Specifications

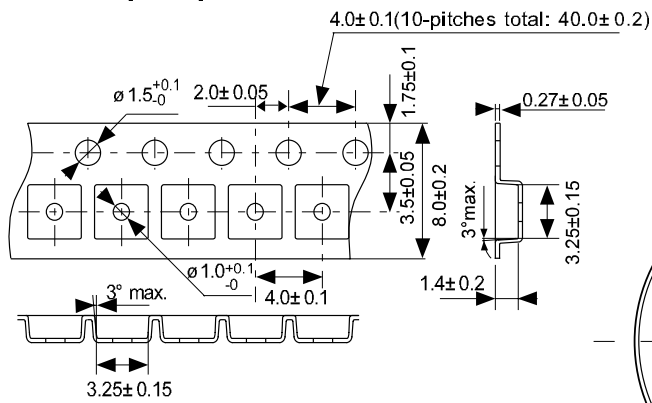

3000 pcs./reel

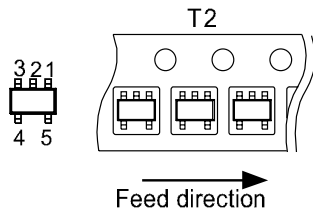
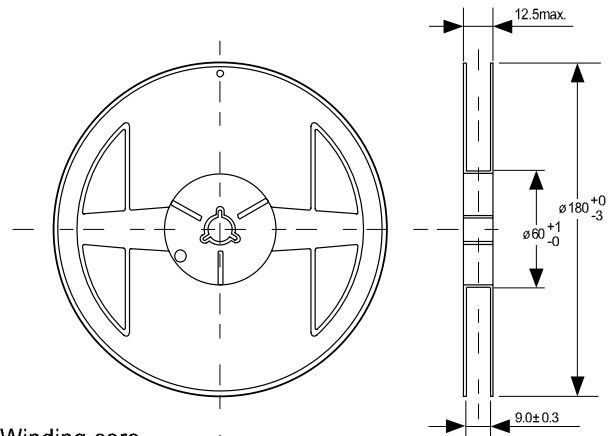

No. : MP005-A-C-SD-1.0

Winding core

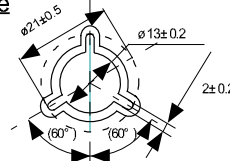

No. MP005-A-R-SD-1.0