



QUAD RAIL-TO-RAIL CMOS OPERATIONAL AMPLIFIER

GENERAL DESCRIPTION

The ALD4704 is a quad CMOS monolithic operational amplifier with MOSFET input that has rail-to-rail input and output voltage ranges. The input voltage can be beyond positive power supply voltage V^+ or the negative power supply voltage V^- by up to 300mV. The output voltage swings to within 60mV of either positive or negative power supply voltages at rated load.

With high impedance load, the output voltage approaches to within 1mV of the power supply rails. This device is designed as an alternative to the popular J-FET input operational amplifiers in applications where lower operating voltages, such as 9V battery or $\pm 3.25V$ to $\pm 6V$ power supplies are being used. It offers high slew rate of $5V/\mu s$ at low operating power. The ALD4704 is designed and manufactured with Advanced Linear Devices' standard enhanced ACMOS silicon gate CMOS process for low unit cost and exceptional reliability.

The rail-to-rail input and output feature of the ALD4704 expand signal voltage range for a given operating supply voltage and allow numerous analog serial stages to be implemented without losing operating voltage margin. The output stage is designed to drive up to 10mA into 400pF capacitive and 1.5K Ω resistive loads at unity gain and up to 4000pF at a gain of 5. Short circuit protection to either ground or the power supply rails is at approximately 15mA clamp current. The output can both source and sink 10mA into a load with symmetrical drive and is ideally suited for applications where push-pull voltage drive is desired.

For each of the operational amplifier, the offset voltage is trimmed on-chip to eliminate the need for external nulling in many applications. For precision applications, the output is designed to settle to 0.1% in 2 μs . For large signal buffer applications, the operational amplifier can function as an ultrahigh input impedance voltage follower/buffer that allows input and output voltage swings from positive to negative supply voltages. This feature is intended to greatly simplify systems design and eliminate higher voltage power supplies in many applications.

FEATURES

- Rail-to-rail input and output voltage ranges
- 5.0V/ μs slew rate
- Symmetrical push-pull output drive
- Inputs can extend beyond supply rails by 300mV
- Outputs settle to 2mV of supply rails
- High capacitive load capability -- up to 4000pF
- No frequency compensation required -- unity gain stable
- Extremely low input bias currents -- 1.0pA typical (20pA max.)
- Ideal for high source impedance applications
- High voltage gain -- typically 100V/mV
- Output short circuit protected
- Unity gain bandwidth of 2.1MHz

APPLICATIONS

- Voltage amplifier
- Voltage follower/buffer
- Charge integrator
- Photodiode amplifier
- Data acquisition systems
- High performance portable instruments
- Signal conditioning circuits
- Low leakage amplifiers
- Active filters
- Sample/Hold amplifier
- Picoammeter
- Current to voltage converter
- Coaxial cable driver
- Capacitive sensor amplifier
- Piezoelectric transducer amplifier

ORDERING INFORMATION

Operating Temperature Range*		
-55°C to +125°C	0°C to +70°C	0°C to +70°C
14-Pin CERDIP Package	14-Pin Small Outline Package (SOIC)	14-Pin Plastic Dip Package
ALD4704A DB	ALD4704A SB	ALD4704A PB
ALD4704B DB	ALD4704B SB	ALD4704B PB
ALD4704 DB	ALD4704 SB	ALD4704 PB

* Contact factory for industrial temperature range

PIN CONFIGURATION

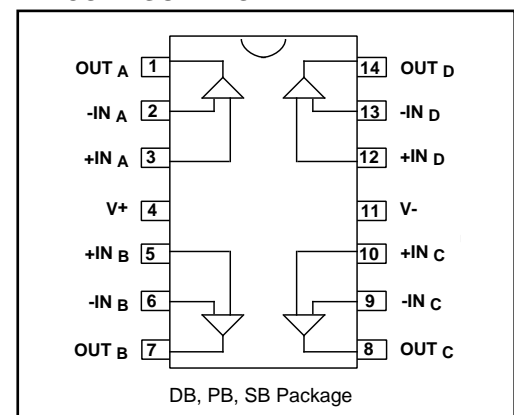

ABSOLUTE MAXIMUM RATINGS

Supply voltage, V_S referenced to V₋ _____ -0.3V to V₊+13.2V
 Supply voltage, V_S referenced to V₋ _____ ±6.6V
 Differential input voltage range _____ -0.3V to V₊+0.3V
 Power dissipation _____ 600 mW
 Operating temperature range PB, SB package _____ 0°C to +70°C
 DB package _____ -55°C to +125°C
 Storage temperature range _____ -65°C to +150°C
 Lead temperature, 10 seconds _____ +260°C

OPERATING ELECTRICAL CHARACTERISTICS

T_A = 25°C V_S = ±5.0V unless otherwise specified

Parameter	Symbol	4704A			4704B			4704			Unit	Test Conditions
		Min	Typ	Max	Min	Typ	Max	Min	Typ	Max		
Supply Voltage	V _S	±3.25		±6.0	±3.25		±6.0	±3.25		±6.0	V	Dual Supply
	V ₊	6.5		12.0	6.5		12.0	6.5		12.0	V	Single Supply
Input Offset Voltage	V _{OS}			1.0			2.0			5.0	mV	R _S ≤ 100KΩ 0°C ≤ T _A ≤ +70°C
				1.5			3.0			6.0	mV	
Input Offset Current	I _{OS}		1.0	15		1.0	15		1.0	15	pA	T _A = 25°C 0°C ≤ T _A ≤ +70°C
				240			240			240	pA	
Input Bias Current	I _B		1.0	20		1.0	20		1.0	20	pA	T _A = 25°C 0°C ≤ T _A ≤ +70°C
				300			300			300	pA	
Input Voltage Range	V _{IR}	-5.3		5.3	-5.3		5.3	-5.3		5.3	V	
Input Resistance	R _{IN}		10 ¹²			10 ¹²			10 ¹²		Ω	
Input Offset Voltage Drift	TCV _{OS}		5			5			5		μV/°C	R _S ≤ 100KΩ
Power Supply Rejection Ratio	PSRR	65	80		65	80		60	80		dB	R _S ≤ 100KΩ 0°C ≤ T _A ≤ +70°C
Common Mode Rejection Ratio	CMRR	65	83		65	83		60	83		dB	R _S ≤ 100KΩ 0°C ≤ T _A ≤ +70°C
Large Signal Voltage Gain	A _V	15	28		15	28		10	28		V/mV	R _L = 100KΩ R _L ≥ 1MΩ R _L = 10KΩ
			100			100			100		V/mV	
Output Voltage Range	V _O low		-4.96	-4.90		-4.96	-4.90		-4.96	-4.90	V	R _L = 10KΩ 0°C ≤ T _A ≤ +70°C
	V _O high	4.90	4.95		4.90	4.95		4.90	4.95		V	
	V _O low		-4.998	-4.99		-4.998	-4.99		-4.998	-4.99	V	
Output Short Circuit Current	I _{SC}		15			15			15		mA	
Supply Current	I _S		10	13		10	13		10	13	mA	V _{IN} = -5.0V No Load
Power Dissipation	P _D			130			130			130	mW	All amplifiers, No Load V _S = ±5.0V
Input Capacitance	C _{IN}		1			1			1		pF	
Bandwidth	B _W		2.1			2.1			2.1		MHz	
Slew Rate	S _R		5.0			5.0			5.0		V/μs	A _V = +1 R _L = 2.0KΩ
Rise time	t _r		0.1			0.1			0.1		μs	R _L = 10KΩ
Overshoot Factor			15			15			15		%	R _L = 10KΩ C _L = 100pF

OPERATING ELECTRICAL CHARACTERISTICS (cont'd)
T_A = 25°C V_S = ±5.0V unless otherwise specified

Parameter	Symbol	4704A			4704B			4704			Unit	Test Conditions
		Min	Typ	Max	Min	Typ	Max	Min	Typ	Max		
Maximum Load Capacitance	C _L		400 4000			400 4000			400 4000		pF pF	Gain = 1 Gain = 5
Input Noise Voltage	e _n		26			26			26		nV/√Hz	f = 1KHz
Input Current Noise	i _n		0.6			0.6			0.6		fA/√Hz	f = 10Hz
Settling Time	t _s		5.0 2.0			5.0 2.0			5.0 2.0		μs μs	0.01% 0.1% A _v = -1 R _L = 5KΩ C _L = 50pF

V_S = ±5.0V -55°C ≤ T_A ≤ +125°C unless otherwise specified

Parameter	Symbol	4704A DB			4704B DB			4704DB			Unit	Test Conditions
		Min	Typ	Max	Min	Typ	Max	Min	Typ	Max		
Input Offset Voltage	V _{OS}			2.0			4.0			7.0	mV	R _S ≤ 100KΩ
Input Offset Current	I _{OS}			8.0			8.0			8.0	nA	
Input Bias Current	I _B			10.0			10.0			10.0	nA	
Power Supply Rejection Ratio	PSRR	60	75		60	75		60	75		dB	R _S ≤ 100KΩ
Common Mode Rejection Ratio	CMRR	60	83		60	83		60	83		dB	R _S ≤ 100KΩ
Large Signal Voltage Gain	A _V	10	25		10	25		10	25		V/mV	R _L = 10KΩ
Output Voltage Range	V _O low V _O high	4.8	-4.9 4.9	-4.8	4.8	-4.9 4.9	-4.8	4.8	-4.9 4.9	-4.8	V V	R _L = 10KΩ R _L = 10KΩ

Design & Operating Notes:

- The ALD4704 CMOS operational amplifier uses a 3 gain stage architecture and an improved frequency compensation scheme to achieve large voltage gain, high output driving capability, and better frequency stability. The ALD4704 is internally compensated for unity gain stability using a novel scheme. This design produces a clean single pole roll off in the gain characteristics while providing for more than 70 degrees of phase margin at the unity gain frequency. A unity gain buffer using the ALD4704 will typically drive 400pF of external load capacitance without stability problems. In the inverting unity gain configuration, it can drive up to 800pF of load capacitance. Compared to other CMOS operational amplifiers, the ALD4704 is much more resistant to parasitic oscillations.
- The ALD4704 has complementary p-channel and n-channel input differential stages connected in parallel to accomplish rail to rail input common mode voltage range. With the common mode input voltage close to the power supplies, one of the two differential stages is switched off internally. To maintain compatibility with other operational amplifiers, this switching point has been selected to be about 1.5V above the negative supply voltage. As offset voltage trimming on the ALD4704 is made when the input voltage is symmetrical to the supply voltages, this internal switching does not affect a large variety of applications such as an inverting amplifier or non-inverting amplifier with a gain greater than 2.5 (5V operation), where the common mode voltage does not make excursions below this switching point.
- The input bias and offset currents are essentially input protection diode reverse bias leakage currents, and are typically less than 1pA at room temperature. This low input bias current assures that the analog signal from the source will not be distorted by input bias currents. For applications where source impedance is very high, it may be necessary to limit noise and hum pickup through proper shielding.
- The output stage consists of class AB complementary output drivers, capable of driving a low resistance load. The output voltage swing is limited by the drain to source on-resistance of the output transistors as determined by the bias circuitry, and the value of the load resistor when connected. In the voltage follower configuration, the oscillation resistant feature, combined with the rail to rail input and output feature, makes the ALD4704 an effective analog signal buffer for medium to high source impedance sensors, transducers, and other circuit networks.
- The ALD4704 operational amplifier has been designed with static discharge protection and to minimize latch up. However, care must be exercised when handling the device to avoid strong static fields. In using the operational amplifier, the user is advised to power up the circuit before, or simultaneously with, any input voltages applied and to limit input voltages to not exceed 0.3V of the power supply voltage levels. Alternatively, a 100KΩ or higher value resistor at the input terminals will limit input currents to acceptable levels while causing very small or negligible accuracy effects.

TYPICAL PERFORMANCE CHARACTERISTICS

COMMON MODE INPUT VOLTAGE RANGE AS A FUNCTION OF SUPPLY VOLTAGE

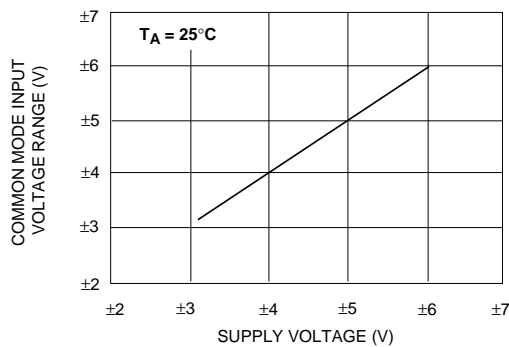

OPEN LOOP VOLTAGE GAIN AS A FUNCTION OF SUPPLY VOLTAGE AND TEMPERATURE

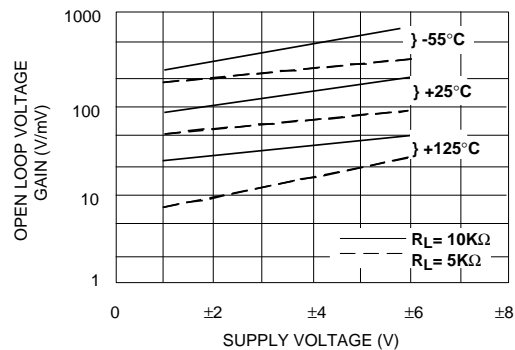

INPUT BIAS CURRENT AS A FUNCTION OF AMBIENT TEMPERATURE

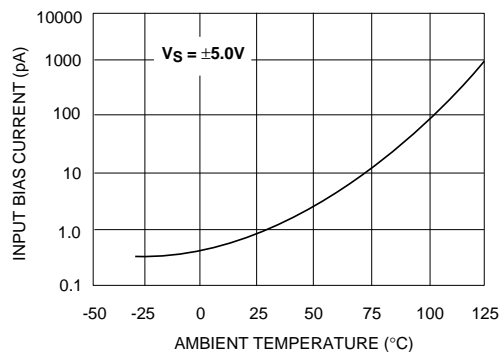

SUPPLY CURRENT AS A FUNCTION OF SUPPLY VOLTAGE

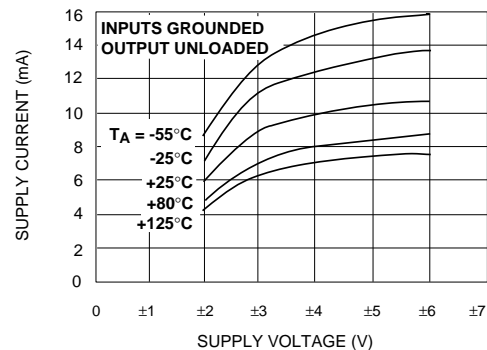

TYPICAL PERFORMANCE CHARACTERISTICS

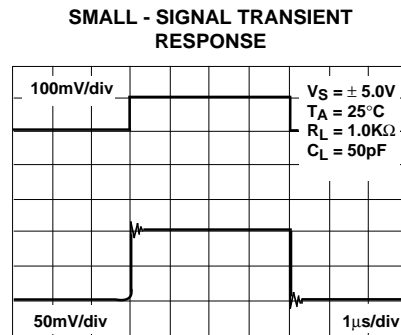
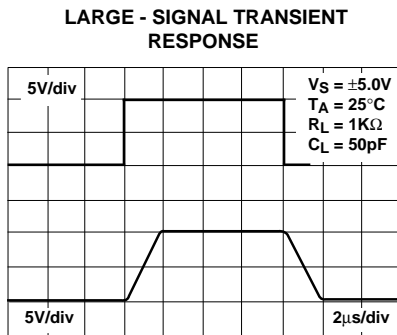
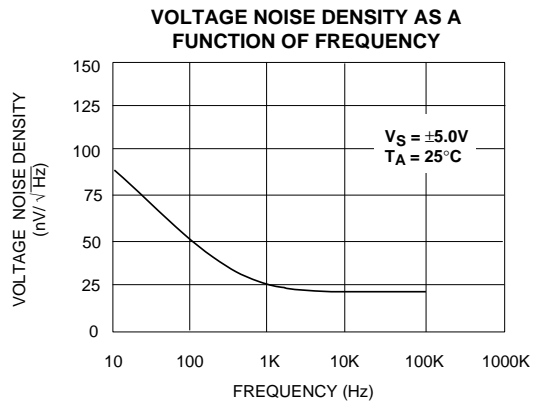
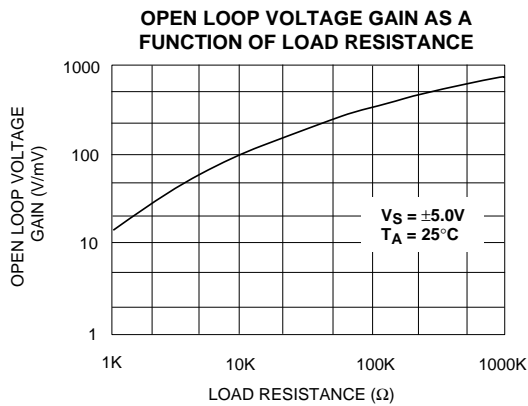
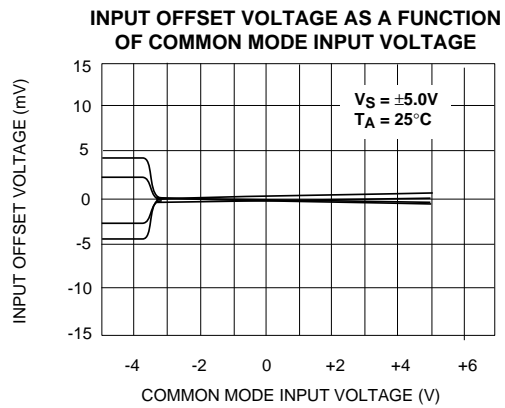
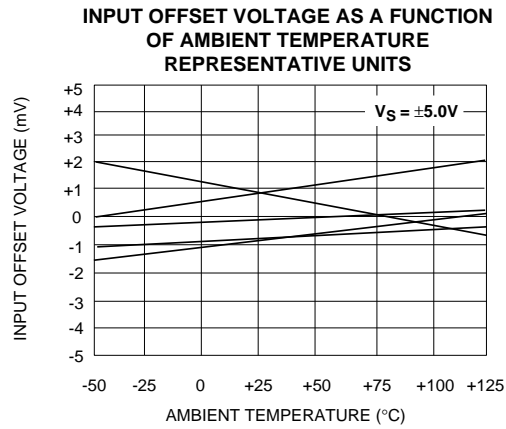
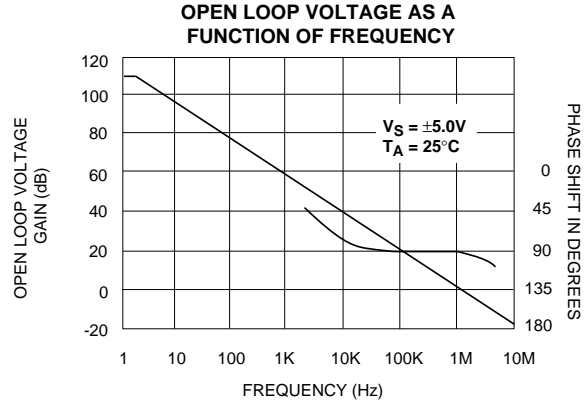
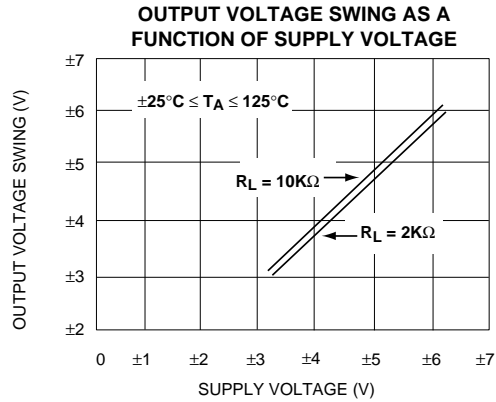

TYPICAL APPLICATIONS

RAIL-TO-RAIL VOLTAGE FOLLOWER/BUFFER

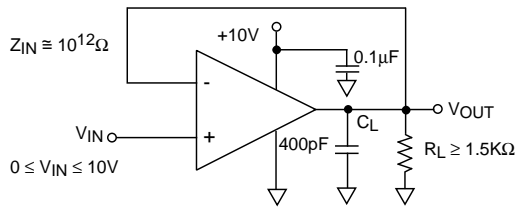

RAIL-TO-RAIL VOLTAGE COMPARATOR

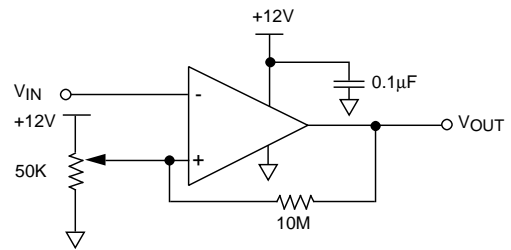

LOW OFFSET SUMMING AMPLIFIER

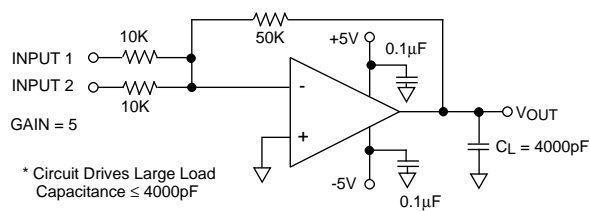
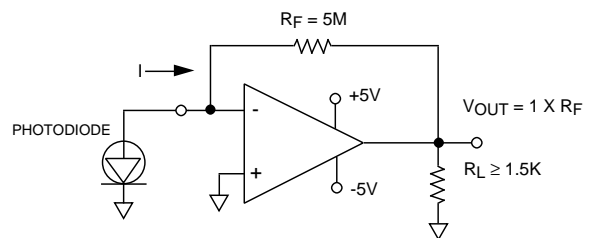
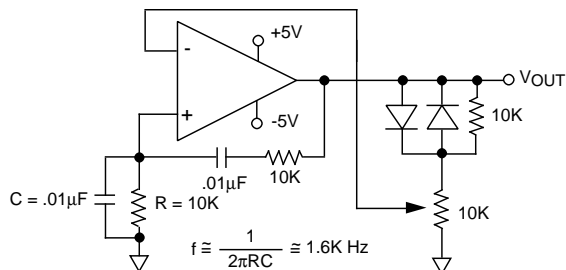

PHOTO DETECTOR CURRENT TO VOLTAGE CONVERTER



WIEN BRIDGE OSCILLATOR (RAIL-TO-RAIL) SINE WAVE GENERATOR



PRECISION CHARGE INTEGRATOR

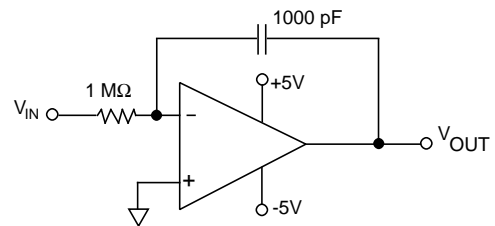

LOW PASS FILTER (RFI FILTER)

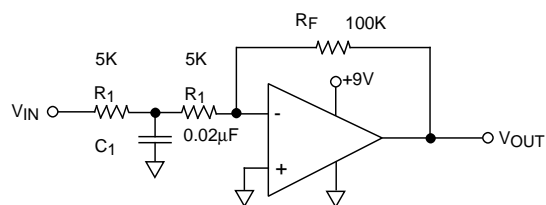

$$\text{Cutoff frequency} = \frac{1}{\pi R_1 C_1} = 3.2\text{kHz}$$

$$\text{Gain} = 10 \quad \text{Frequency roll-off } 20\text{dB/decade}$$

BANDPASS NETWORK

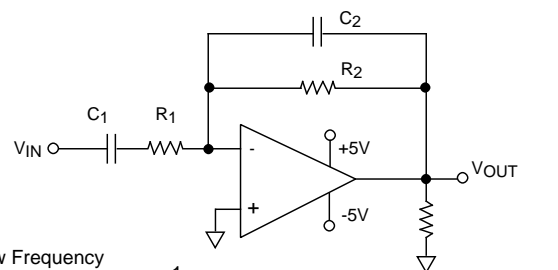

$$\text{Low Frequency Breakpoint } f_L = \frac{1}{2\pi R_1 C_1} = 160\text{Hz}$$

$$\text{High Frequency Cutoff } f_H = \frac{1}{2\pi R_2 C_2} = 32\text{kHz}$$

$$\begin{aligned} R_1 &= 10\text{K} \\ C_1 &= 100\text{nF} \\ R_2 &= 10\text{K} \\ C_2 &= 500\text{pF} \end{aligned}$$