



## QUAD 5V RAIL-TO-RAIL PRECISION OPERATIONAL AMPLIFIER

### GENERAL DESCRIPTION

The ALD4702 is a quad monolithic precision CMOS rail-to-rail operational amplifier intended for a broad range of analog applications using  $\pm 2.5V$  to  $\pm 6V$  dual power supply systems, as well as  $+4V$  to  $+12V$  battery operated systems. All device characteristics are specified for  $+5V$  single supply or  $\pm 2.5V$  dual supply systems. Total supply current for four operational amplifiers is 6mA maximum at 5V supply voltage. It is manufactured with Advanced Linear Devices' enhanced ACMOS silicon gate CMOS process.

The ALD4702 is designed to offer a trade-off of performance parameters providing a wide range of desired specifications. It offers the popular industry pin configuration of LM324 and ICL7641 types.

The ALD4702 has been developed specifically with the  $+5V$  single supply or  $\pm 2.5V$  dual supply user. Several important characteristics of the device make many applications easy to implement for these supply voltages. First, the operational amplifier can operate with rail to rail input and output voltages. This feature allows numerous analog serial stages to be implemented without losing operating voltage margin. Secondly, the device was designed to accommodate mixed applications where digital and analog circuits may work off the same 5V power supply. Thirdly, the output stage can drive up to 400pF capacitive and 5K $\Omega$  resistive loads in non-inverting unity gain connection and double the capacitance in the inverting unity gain mode.

These features, coupled with extremely low input currents, high voltage gain, useful bandwidth of 1.5MHz, a slew rate of 2.1V/ $\mu s$ , low power dissipation, low offset voltage and temperature drift, make the ALD4702 a truly versatile, user friendly, operational amplifier.

The ALD4702 is designed and fabricated with silicon gate CMOS technology, and offers 1pA typical input bias current. On-chip offset voltage trimming allows the device to be used without nulling in most applications. The device offers typical offset drift of less than 7 $\mu V/^\circ C$  which eliminates many trim or temperature compensation circuits. For precision applications, the ALD4702 is designed to settle to 0.01% in 8 $\mu s$ .

### FEATURES

- Rail-to-rail input and output voltage ranges
- Symmetrical push-pull class AB output drivers
- All parameters specified for  $+5V$  single supply or  $\pm 2.5V$  dual supply systems
- Inputs can extend beyond supply rails by 300mV
- Outputs settle to 2mV of supply rails
- High load capacitance capability up to 4000pF
- No frequency compensation required -- unity gain stable
- Extremely low input bias currents -- 1.0pA typical
- Ideal for high source impedance applications
- Dual power supply  $\pm 2.5V$  to  $\pm 5.0V$  operation
- Single power supply  $+5V$  to  $+12V$  operation
- High voltage gain-typically 85V/mV @  $\pm 2.5V$  and 250V/mV @  $\pm 5.0V$
- Drive as low as 2K $\Omega$  load with 5mA drive current
- Output short circuit protected
- Unity gain bandwidth of 1.5MHz
- Slew rate of 1.9V/ $\mu s$
- Low power dissipation

### APPLICATIONS

- Voltage amplifier
- Voltage follower/buffer
- Charge integrator
- Photodiode amplifier
- Data acquisition systems
- High performance portable instruments
- Signal conditioning circuits
- Sensor and transducer amplifiers
- Low leakage amplifiers
- Active filters
- Sample/Hold amplifier
- Picoammeter
- Current to voltage convert
- Coaxial cable driver

### ORDERING INFORMATION

Operating Temperature Range*		
-55 $^\circ C$ to +125 $^\circ C$	0 $^\circ C$ to +70 $^\circ C$	0 $^\circ C$ to +70 $^\circ C$
14-Pin CERDIP Package	14-Pin Small Outline Package (SOIC)	14-Pin Plastic Dip Package
ALD4702A DB	ALD4702A SB	ALD4702A PB
ALD4702B DB	ALD4702B SB	ALD4702B PB
ALD4702 DB	ALD4702 SB	ALD4702 PB

\* Contact factory for industrial temperature range

### PIN CONFIGURATION

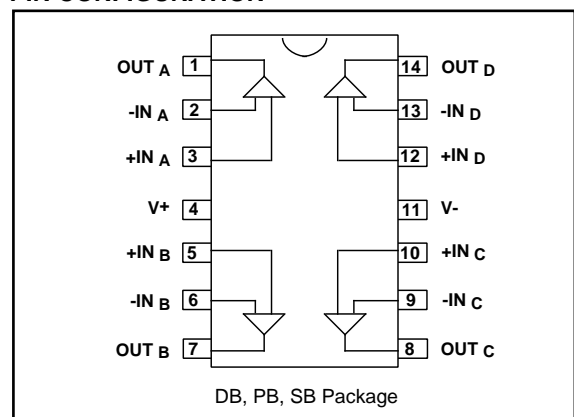

## ABSOLUTE MAXIMUM RATINGS

Supply voltage, V <sub>S</sub> referenced to V <sup>-</sup>	-0.3V to V <sup>+</sup> +13.2V
Supply voltage, V <sub>S</sub> referenced to V <sup>-</sup>	±6.6V
Differential input voltage range	-0.3V to V <sup>+</sup> +0.3V
Power dissipation	600 mW
Operating temperature range PB, SB package	0°C to +70°C
DB package	-55°C to +125°C
Storage temperature range	-65°C to +150°C
Lead temperature, 10 seconds	+260°C

## OPERATING ELECTRICAL CHARACTERISTICS

T<sub>A</sub> = 25°C V<sub>S</sub> = ±2.5V unless otherwise specified

Parameter	Symbol	4702A			4702B			4702			Unit	Test Conditions
		Min	Typ	Max	Min	Typ	Max	Min	Typ	Max		
Supply Voltage	V <sub>S</sub> V <sup>+</sup>	±2.0 4.0		±6.0 12.0	±2.0 4.0		±6.0 12.0	±2.0 4.0		±6.0 12.0	V V	Dual Supply Single Supply
Input Offset Voltage	V <sub>OS</sub>			1.0 2.0			2.0 3.5			5.0 6.5	mV mV	R <sub>S</sub> ≤ 100KΩ 0°C ≤ T <sub>A</sub> ≤ +70°C
Input Offset Current	I <sub>OS</sub>		1.0	25 240		1.0	25 240		1.0	25 240	pA pA	T <sub>A</sub> = 25°C 0°C ≤ T <sub>A</sub> ≤ +70°C
Input Bias Current	I <sub>B</sub>		1.0	30 300		1.0	30 300		1.0	30 300	pA pA	T <sub>A</sub> = 25°C 0°C ≤ T <sub>A</sub> ≤ +70°C
Input Voltage Range	V <sub>IR</sub>	-0.3 -2.8		5.3 +2.8	-0.3 -2.8		5.3 +2.8	-0.3 -2.8		5.3 +2.8	V V	V <sup>+</sup> = +5V V <sub>S</sub> = ±2.5V
Input Resistance	R <sub>IN</sub>		10 <sup>12</sup>			10 <sup>12</sup>			10 <sup>12</sup>		Ω	
Input Offset Voltage Drift	TCV <sub>OS</sub>		7			7			7		μV/°C	R <sub>S</sub> ≤ 100KΩ
Power Supply Rejection Ratio	PSRR	65 65	83 83		65 65	83 83		60 60	83 83		dB	R <sub>S</sub> ≤ 100KΩ 0°C ≤ T <sub>A</sub> ≤ +70°C
Common Mode Rejection Ratio	CMRR	65 65	83 83		65 65	83 83		60 60	83 83		dB	R <sub>S</sub> ≤ 100KΩ 0°C ≤ T <sub>A</sub> ≤ +70°C
Large Signal Voltage Gain	A <sub>V</sub>	15	28 100		15	28 100		12	28 100		V/mV V/mV	R <sub>L</sub> = 10KΩ R <sub>L</sub> ≥ 1MΩ
Output Voltage Range	V <sub>O</sub> low V <sub>O</sub> high	4.99	0.002 4.998	0.01	4.99	0.002 4.998	0.01	4.99	0.002 4.998	0.01	V	R <sub>L</sub> = 1MΩ Single supply 0°C ≤ T <sub>A</sub> ≤ +70°C
	V <sub>O</sub> low V <sub>O</sub> high	2.40	-2.44 2.44	-2.40	2.40	-2.44 2.44	-2.40	2.40	-2.44 2.44	-2.40	V	R <sub>L</sub> = 10KΩ Dual supply 0°C ≤ T <sub>A</sub> ≤ +70°C
Output Short Circuit Current	I <sub>SC</sub>		8			8			8		mA	
Supply Current	I <sub>S</sub>		4.0	6.0		4.0	6.0		4.0	6.0	mA	V <sub>IN</sub> = 0V No Load
Power Dissipation	P <sub>D</sub>		20	30		20	30		20	30	mW	V <sub>S</sub> = ±2.5V All four amplifiers
Input Capacitance	C <sub>IN</sub>		1			1			1		pF	
Bandwidth	B <sub>W</sub>	0.7	1.5		0.7	1.5		0.7	1.5		MHz	
Slew Rate	S <sub>R</sub>	1.1	1.9		1.1	1.9		1.1	1.9		V/μs	A <sub>V</sub> = +1 R <sub>L</sub> = 10KΩ
Rise time	t <sub>r</sub>		0.2			0.2			0.2		μs	R <sub>L</sub> = 10KΩ
Overshoot Factor			10			10			10		%	R <sub>L</sub> = 10KΩ C <sub>L</sub> = 100pF

**OPERATING ELECTRICAL CHARACTERISTICS (cont'd)**

**T<sub>A</sub> = 25°C V<sub>S</sub> = ±2.5V unless otherwise specified**

Parameter	Symbol	4702A			4702B			4702			Uni	Test Conditions
		Min	Typ	Max	Min	Typ	Max	Min	Typ	Max		
Maximum Load Capacitance	C <sub>L</sub>		400 4000			400 4000			400 4000		pF pF	Gain = 1 Gain = 5
Input Noise Voltage	e <sub>n</sub>		26			26			26		nV/√Hz	f = 1KHz
Input Current Noise	i <sub>n</sub>		0.6			0.6			0.6		fA/√Hz	f = 10Hz
Settling Time	t <sub>s</sub>		8.0 3.0			8.0 3.0			8.0 3.0		μs μs	0.01% 0.1% A <sub>V</sub> = -1 R <sub>L</sub> = 5KΩ C <sub>L</sub> = 50pF

**T<sub>A</sub> = 25°C V<sub>S</sub> = ±5.0V unless otherwise specified**

Parameter	Symbol	4702A			4702B			4702			Unit	Test Conditions
		Min	Typ	Max	Min	Typ	Max	Min	Typ	Max		
Power Supply Rejection Ratio	PSRR		83			83			83		dB	R <sub>S</sub> ≤ 100KΩ
Common Mode Rejection Ratio	CMRR		83			83			83		dB	R <sub>S</sub> ≤ 100KΩ
Large Signal Voltage Gain	A <sub>V</sub>		250			250			250		V/mV	R <sub>L</sub> = 10KΩ
Output Voltage Range	V <sub>O low</sub> V <sub>O high</sub>	4.8	-4.90 4.93	-4.8	4.8	-4.90 4.93	-4.8	4.8	-4.90 4.93	-4.8	V	R <sub>L</sub> = 10KΩ
Bandwidth	BW		1.7			1.7			1.7		MHz	
Slew Rate	SR		2.8			2.8			2.8		V/μs	A <sub>V</sub> = +1 C <sub>L</sub> = 50pF

**V<sub>S</sub> = +5.0V -55°C ≤ T<sub>A</sub> ≤ +125°C unless otherwise specified**

Parameter	Symbol	4702A DA			4702B DA			4702 DA			Unit	Test Conditions
		Min	Typ	Max	Min	Typ	Max	Min	Typ	Max		
Input Offset Voltage	V <sub>OS</sub>			2.0			4.0			7.0	mV	R <sub>S</sub> ≤ 100KΩ
Input Offset Current	I <sub>OS</sub>			8.0			8.0			8.0	nA	
Input Bias Current	I <sub>B</sub>			10.0			10.0			10.0	nA	
Power Supply Rejection Ratio	PSRR	60	75		60	75		60	75		dB	R <sub>S</sub> ≤ 100KΩ
Common Mode Rejection Ratio	CMRR	60	83		60	83		60	83		dB	R <sub>S</sub> ≤ 100KΩ
Large Signal Voltage Gain	A <sub>V</sub>	10	25		10	25		7	25		V/mV	A <sub>V</sub> = +1 R <sub>L</sub> ≤ 10KΩ
Output Voltage Range	V <sub>O low</sub> V <sub>O high</sub>	4.8	0.1 4.9	0.2	4.8	0.1 4.9	0.2	4.8	0.1 4.9	0.2	V	R <sub>L</sub> ≤ 10KΩ

**Design & Operating Notes:**

1. The ALD4702 CMOS operational amplifier uses a 3 gain stage architecture and an improved frequency compensation scheme to achieve large voltage gain, high output driving capability, and better frequency stability. The ALD4702 is internally compensated for unity gain stability using a novel scheme. This design produces a clean single pole roll off in the gain characteristics while providing for more than 70 degrees of phase margin at the unity gain frequency. A unity gain buffer using the ALD4702 will typically drive 400pF of external load capacitance without stability problems. In the inverting unity gain configuration, it can drive up to 800pF of load capacitance. Compared to other CMOS operational amplifiers, the ALD4702 is much more resistant to parasitic oscillations.
2. The ALD4702 has complementary p-channel and n-channel input differential stages connected in parallel to accomplish rail-to-rail input common mode voltage range. With the common mode input voltage close to the power supplies, one of the two differential stages is switched off internally. To maintain compatibility with other operational amplifiers, this switching point has been selected to be about 1.5V above the negative supply voltage. As offset voltage trimming on the ALD4702 is made when the input voltage is symmetrical to the supply voltages, this internal switching does not affect a large variety of applications such as an inverting amplifier or non-inverting amplifier with a gain greater than 2.5 (5V operation), where the common mode voltage does not make excursions below this switching point.
3. The input bias and offset currents are essentially input protection diode

reverse bias leakage currents, and are typically less than 1pA at room temperature. This low input bias current assures that the analog signal from the source will not be distorted by input bias currents. For applications where source impedance is very high, it may be necessary to limit noise and hum pickup through proper shielding.

4. The output stage consists of class AB complementary output drivers, capable of driving a low resistance load. The output voltage swing is limited by the drain to source on-resistance of the output transistors as determined by the bias circuitry, and the value of the load resistor when connected. In the voltage follower configuration, the oscillation resistant feature, combined with the rail to rail input and output feature, makes the ALD4702 an effective analog signal buffer for medium to high source impedance sensors, transducers, and other circuit networks.
5. The ALD4702 operational amplifier has been designed with static discharge protection. Internally, the design has been carefully implemented to minimize latch up. However, care must be exercised when handling the device to avoid strong static fields. In using the operational amplifier, the user is advised to power up the circuit before, or simultaneously with, any input voltages applied and to limit input voltages to not exceed 0.3V of the power supply voltage levels. Alternatively, a 100KΩ or higher value resistor at the input terminals will limit input currents to acceptable levels while causing very small or negligible accuracy effects.

**TYPICAL PERFORMANCE CHARACTERISTICS**

**COMMON MODE INPUT VOLTAGE RANGE AS A FUNCTION OF SUPPLY VOLTAGE**

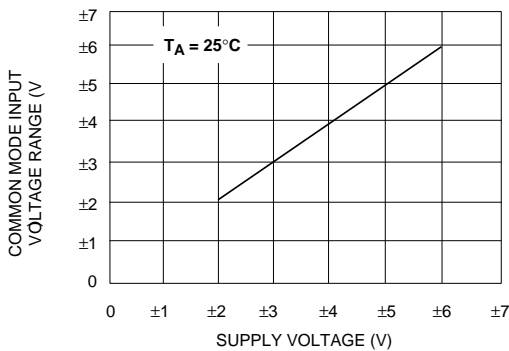

**OPEN LOOP VOLTAGE GAIN AS A FUNCTION OF SUPPLY VOLTAGE AND TEMPERATURE**

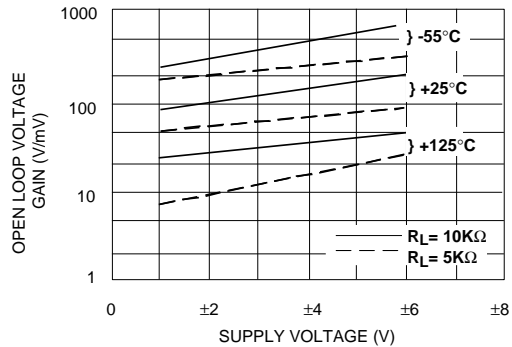

**INPUT BIAS CURRENT AS A FUNCTION OF AMBIENT TEMPERATURE**

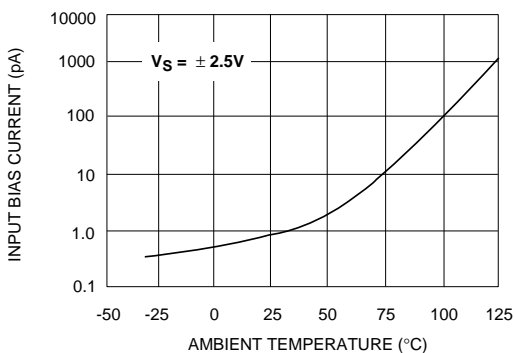

**SUPPLY CURRENT AS A FUNCTION OF SUPPLY VOLTAGE**

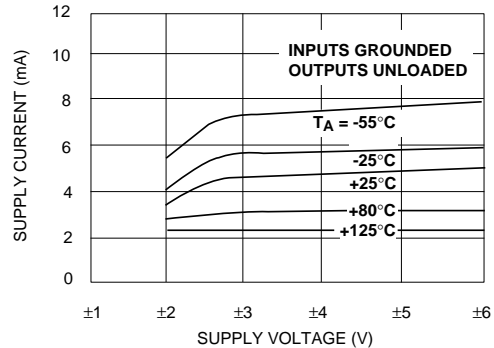

## TYPICAL PERFORMANCE CHARACTERISTICS

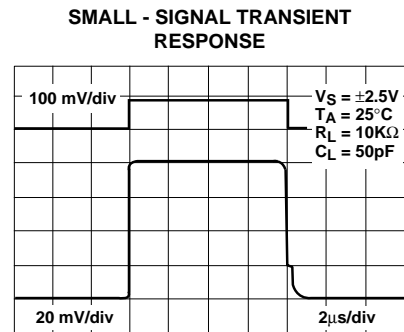
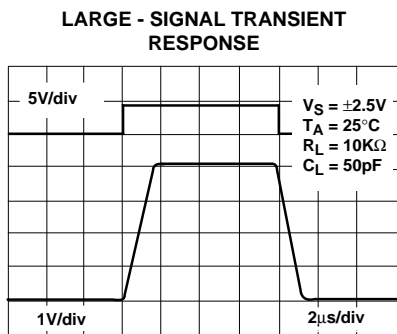
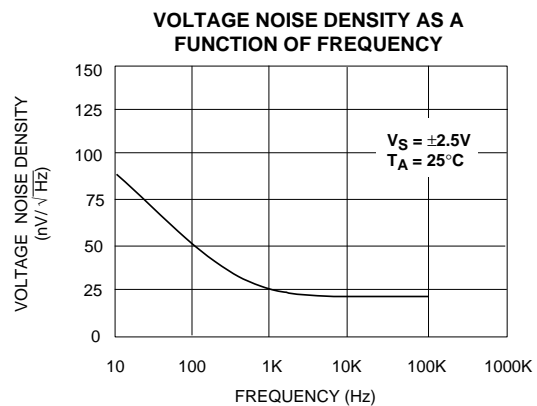
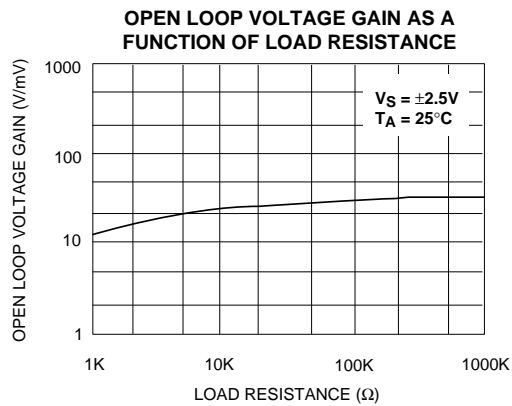
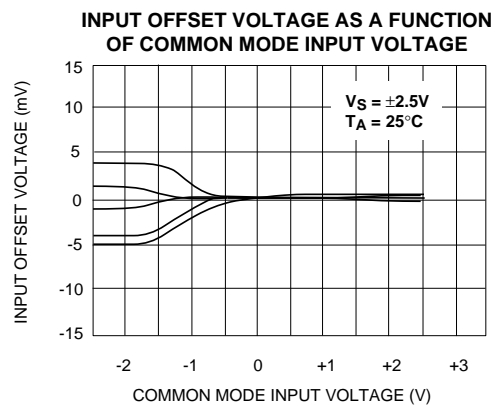
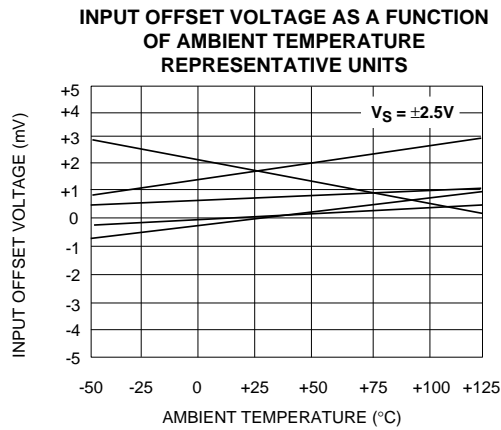
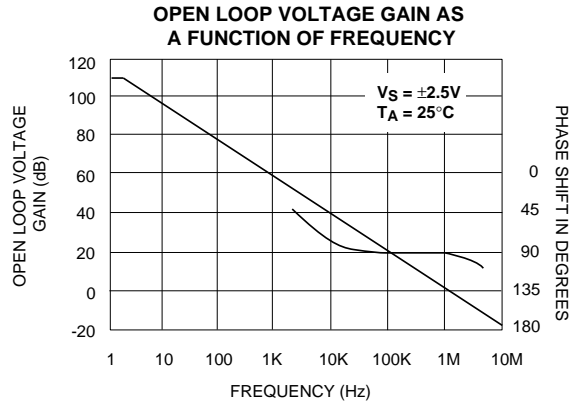
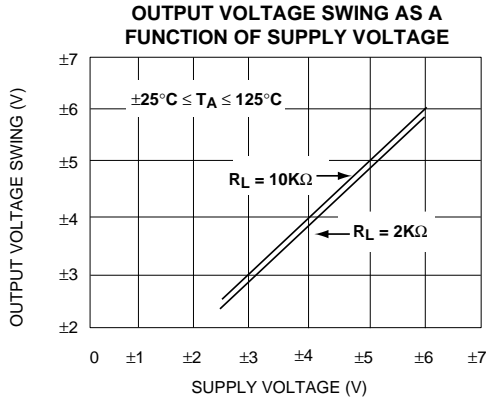

## TYPICAL APPLICATIONS

### RAIL-TO-RAIL VOLTAGE FOLLOWER/BUFFER

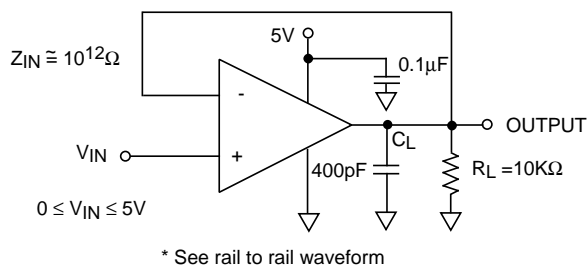

### RAIL-TO-RAIL WAVEFORM

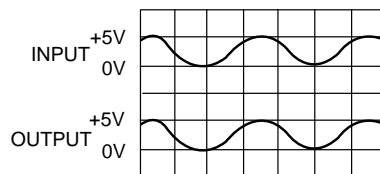

**Performance waveforms.**  
Upper trace is the output of a Wien Bridge Oscillator. Lower trace is the output of Rail-to-Rail voltage follower.

### LOW OFFSET SUMMING AMPLIFIER

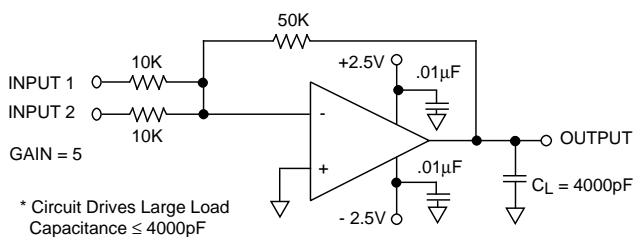

### PHOTO DETECTOR CURRENT TO VOLTAGE CONVERTER

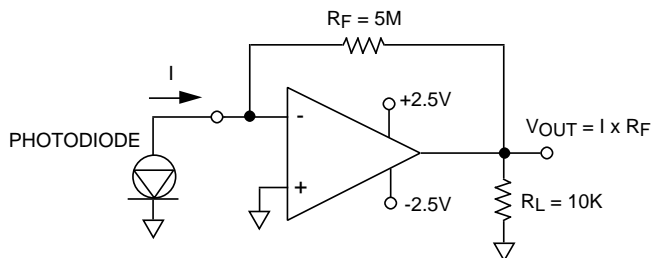

### WIEN BRIDGE OSCILLATOR (RAIL-TO-RAIL) SINE WAVE GENERATOR

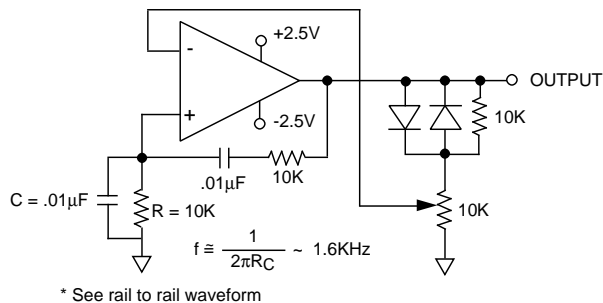

### RAIL-TO-RAIL VOLTAGE COMPARATOR

