



LIGITEK

LIGITEK ELECTRONICS CO.,LTD.
Property of Ligitek Only

ROUND TYPE LED LAMPS

LE12340

DATA SHEET

DOC. NO : QW0905-LE12340

REV. : A

DATE : 03 - May - 2005



Package Dimensions

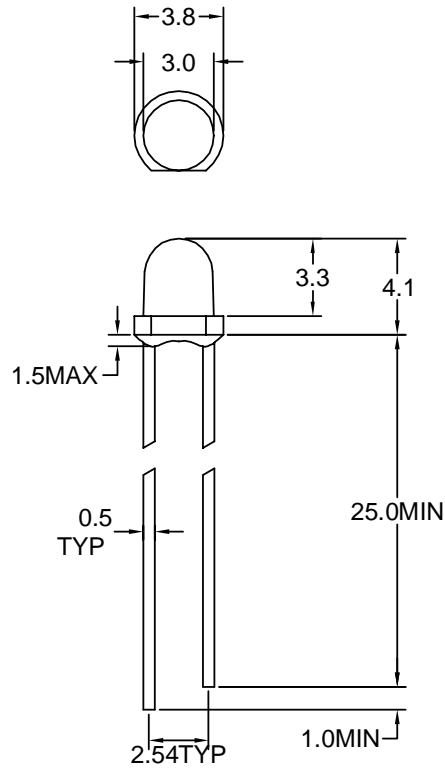

Note : 1.All dimension are in millimeter tolerance is $\pm 0.25\text{mm}$ unless otherwise noted.
2.Specifications are subject to change without notice.

Directivity Radiation

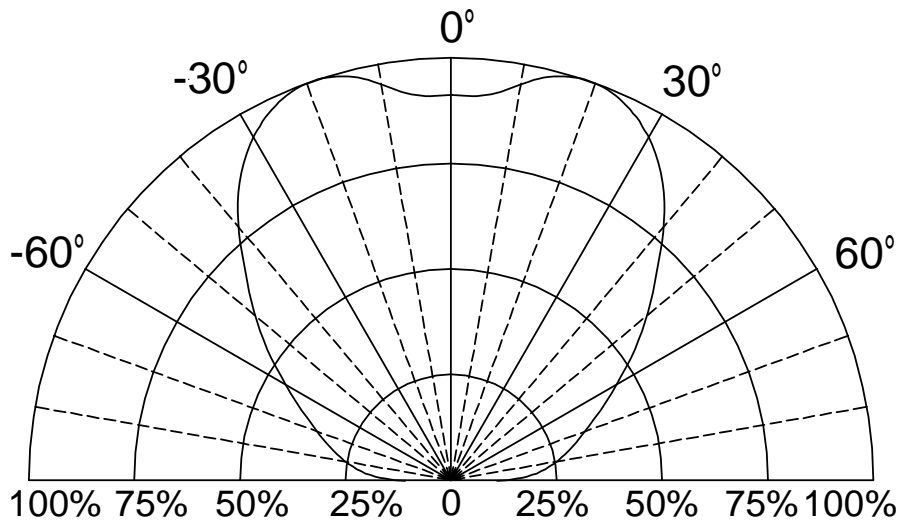



Absolute Maximum Ratings at Ta=25

Parameter	Symbol	Ratings	UNIT
		E	
Forward Current	IF	30	mA
Peak Forward Current Duty 1/10@10KHz	IFP	120	mA
Power Dissipation	PD	100	mW
Reverse Current @5V	Ir	10	μ A
Operating Temperature	Topr	-40 ~ +85	
Storage Temperature	Tstg	-40 ~ +100	
Soldering Temperature	Tsol	Max 260 for 5 sec Max (2mm from body)	

Typical Electrical & Optical Characteristics (Ta=25)

PART NO	MATERIAL	COLOR		Peak wave length Pnm	Spectral halfwidth nm	Forward voltage @20mA(V)		Luminous intensity @10mA(mcd)		Viewing angle 2 1/2 (deg)
		Emitted	Lens			Min.	Max.	Min.	Typ.	
LE12340	GaAsP/GaP	Orange	Orange Diffused	635	45	1.7	2.6	4.5	6.5	112

Note : 1.The forward voltage data did not including ±0.1V testing tolerance.
2. The luminous intensity data did not including ±15% testing tolerance.

Typical Electro-Optical Characteristics Curve

E CHIP

Fig.1 Forward current vs. Forward Voltage

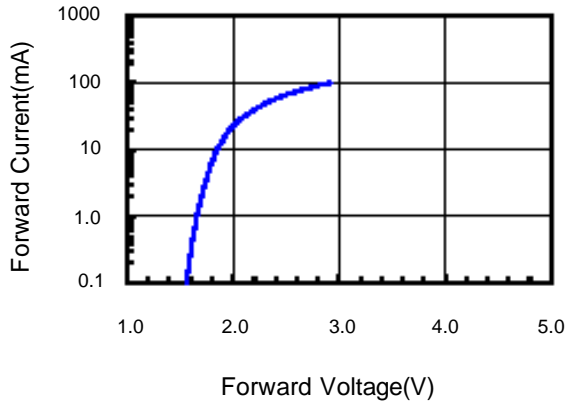

Fig.2 Relative Intensity vs. Forward Current

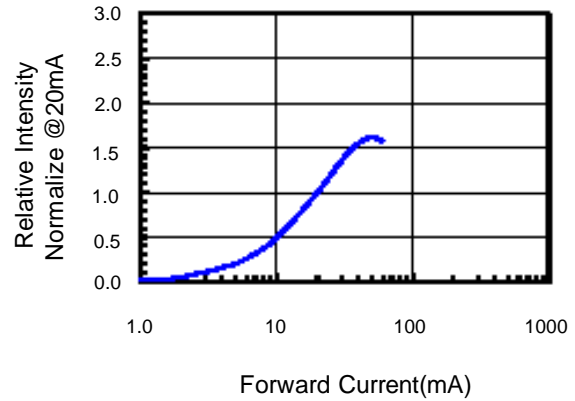

Fig.3 Forward Voltage vs. Temperature

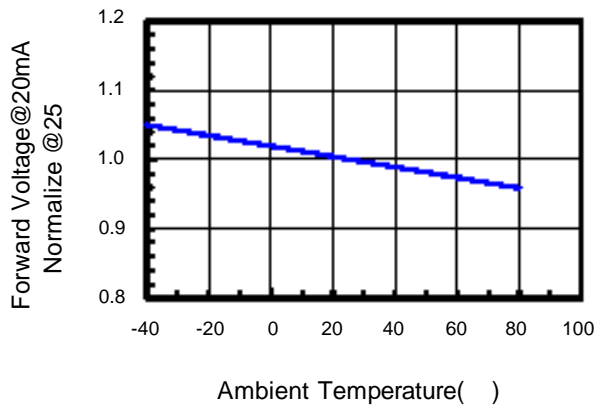

Fig.4 Relative Intensity vs. Temperature

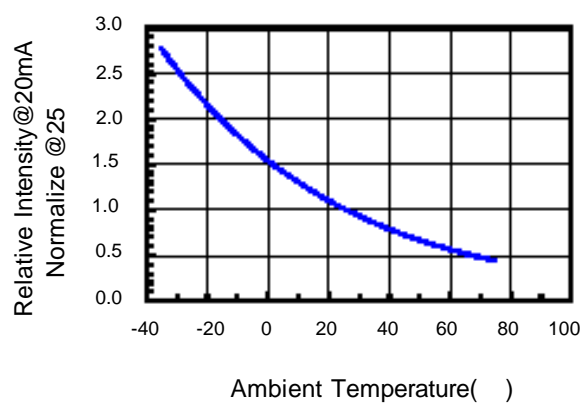
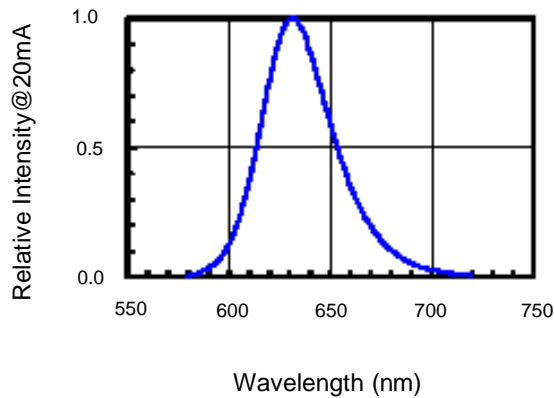

Fig.5 Relative Intensity vs. Wavelength



**Reliability Test:**

Test Item	Test Condition	Description	Reference Standard
Operating Life Test	1.Under Room Temperature 2.If=20mA 3.t=1000 hrs (-24hrs, +72hrs)	This test is conducted for the purpose of determining the resistance of a part in electrical and thermal stressed.	MIL-STD-750: 1026 MIL-STD-883: 1005 JIS C 7021: B-1
High Temperature Storage Test	1.Ta=105 ±5 2.t=1000 hrs (-24hrs, +72hrs)	The purpose of this is the resistance of the device which is laid under condition of high temperature for hours.	MIL-STD-883:1008 JIS C 7021: B-10
Low Temperature Storage Test	1.Ta=-40 ±5 2.t=1000 hrs (-24hrs, +72hrs)	The purpose of this is the resistance of the device which is laid under condition of low temperature for hours.	JIS C 7021: B-12
High Temperature High Humidity Test	1.Ta=65 ±5 2.RH=90 %~95% 3.t=240hrs ±2hrs	The purpose of this test is the resistance of the device under tropical for hours.	MIL-STD-202:103B JIS C 7021: B-11
Thermal Shock Test	1.Ta=105 ±5 & -40 ±5 (10min) (10min) 2.total 10 cycles	The purpose of this is the resistance of the device to sudden extreme changes in high and low temperature.	MIL-STD-202: 107D MIL-STD-750: 1051 MIL-STD-883: 1011
Solder Resistance Test	1.T.Sol=260 ±5 2.Dwell time= 10 ±1sec.	This test intended to determine the thermal characteristic resistance of the device to sudden exposures at extreme changes in temperature when soldering the lead wire.	MIL-STD-202: 210A MIL-STD-750: 2031 JIS C 7021: A-1
Solderability Test	1.T.Sol=230 ±5 2.Dwell time=5 ±1sec	This test intended to see soldering well performed or not.	MIL-STD-202: 208D MIL-STD-750: 2026 MIL-STD-883: 2003 JIS C 7021: A-2