

Output Capacitor-Less, Low Power Consumption, High Speed LDO Regulator

GENERAL DESCRIPTION

The XC6501 series is a 6.0V high speed, low noise CMOS LDO regulator that can provide stable output voltages within a range of 1.2V to 5.0V (0.05V increments) even without a load capacitor C_L . This is possible because phase compensation is carried out internally unlike other LDOs where it is done externally. The series consists of a reference voltage source, driver transistor, error amplifier, current limit circuit, and phase compensation circuit.

The CE function enables the circuit to be put into stand-by mode by inputting a low level signal to the CE pin thereby reducing current consumption from an already low $13\ \mu\text{A}$ (in operation) to less than $0.1\ \mu\text{A}$. In the stand-by mode, if a C_L cap is used, the electric charge stored at C_L can be discharged via the internal auto-discharge switch and as a result, the V_{OUT} pin quickly returns to the V_{SS} level.

The current limit fold-back circuit operates as a short circuit protection and a current limiter function for the output pin.

APPLICATIONS

- Mobile phones (RF, Digital cash, I/O etc.)
- Portable games
- Camera modules
- Wireless LAN modules
- LCD modules
- Bluetooth
- Digital-TV tuners

FEATURES

Operating Voltage Range	:	1.4~6.0V
Output Voltage Range	:	2.0~5.0V (Accuracy: $\pm 1\%$) 1.2~1.95V (Accuracy: $\pm 0.02\text{V}$)
Dropout Voltage	:	150mV@ $I_{\text{OUT}}=100\text{mA}$, $V_{\text{OUT}}=2.8\text{V}$
Low Power Supply	:	$13\ \mu\text{A}$ @ $V_{\text{OUT}}=2.8\text{V}$
Stand-by Current	:	Less than $0.1\ \mu\text{A}$
Ripple Rejection	:	50dB@ $f=1\text{kHz}$, $V_{\text{OUT}}=2.8\text{V}$
Protection Circuits	:	Current limit (300mA, TYP.) Short circuit protection
Output capacitor is not required	:	Internal phase compensation
CL High Speed Auto Discharge	:	
Packages	:	SOT-25, SSOT-24, USP-4, USPN-4 (under development) USP-3

TYPICAL APPLICATION CIRCUIT

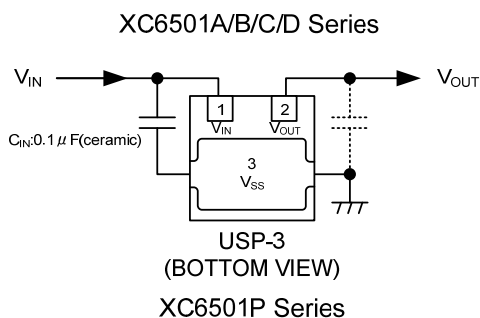
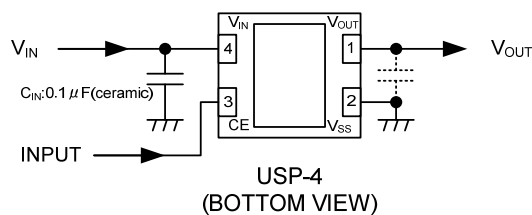

TYPICAL PERFORMANCE CHARACTERISTICS

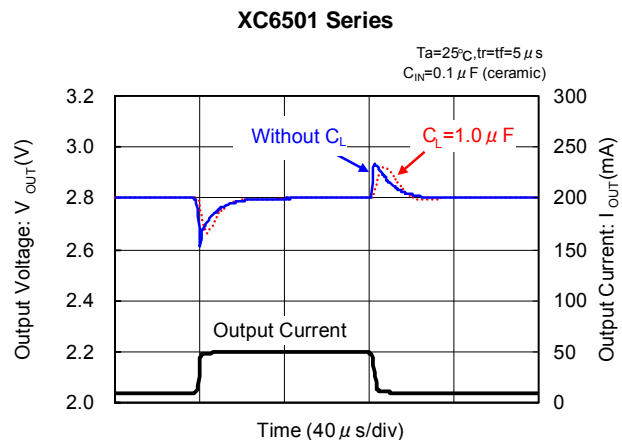

XC6501 Series

PIN CONFIGURATION

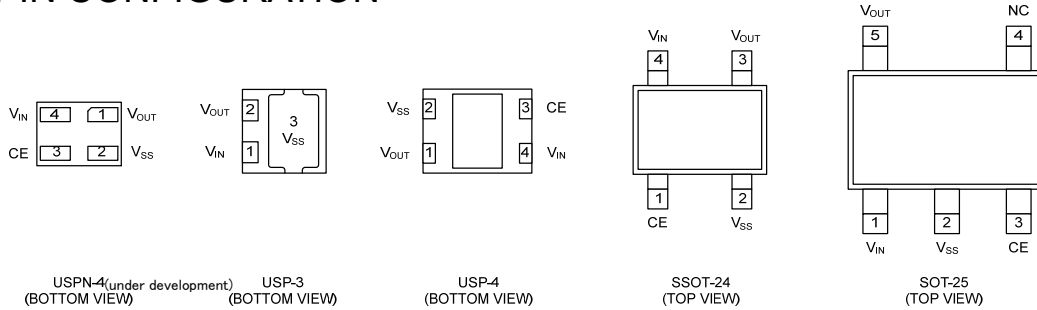

*The heat dissipation pad of the USP-4 package is recommended to solder as the recommended mount pattern and metal mask pattern for mounting strength. The mount pattern should be electrically opened or connected to the V_{SS} (No.2) pin.

PIN ASSIGNMENT

PIN NUMBER					PIN NAME	FUNCTION
USP-3	USP-4	SSOT-24	SOT-25	USPN-4*		
1	4	4	1	4	V _{IN}	Power Supply
2	1	3	5	1	V _{OUT}	Output
3	2	2	2	2	V _{SS}	Ground
-	3	1	3	3	CE	ON/OFF Control
-	-	-	4	-	NC	No Connection

* USP-4 is under development

PRODUCT CLASSIFICATION

Ordering Information

XC6501 - (*)

DESIGNATOR	DESCRIPTION	SYMBOL	DESCRIPTION
①	Regulator Type	A	CE High Active, Without CE Pull-down, Without CL discharge
		B	CE High Active, Without CE Pull-down, With CL discharge
		C	CE High Active, With CE Pull-down, Without CL discharge
		D	CE High Active, With CE Pull-down, With CL discharge
		P	3 pin, without CE pin (USP-3)
②③	Output Voltage	12~50	ex.)28V → ②=2, ③=8
④	Output Voltage Accuracy	1	0.1V increments ex.)1.80V → ②=1, ③=8, ④=1 Accuracy= ±0.02V @ 1.2V~1.9V Accuracy= ±1% @ 2.0~5.0V
		A	0.05V increments ex.)1.85V → ②=1, ③=8, ④=A Accuracy= ±0.02V @ 1.25V~1.95V Accuracy= ±1% @ 2.05~4.95V
⑤⑥-⑦	Packages Taping Type (*)	HR	USP-3 (Only XC6501P)
		HR-G	USP-3 (Halogen & Antimony free)
		GR	USP-4
		GR-G	USP-4 (Halogen & Antimony free)
		NR	SSOT-24
		NR-G	SSOT-24 (Halogen & Antimony free)
		MR	SOT-25
		MR-G	SOT-25 (Halogen & Antimony free)
7R-G	USPN-4 (Halogen & Antimony free) (**)		

(*) The "-G" suffix indicates that the products are Halogen and Antimony free as well as being fully RoHS compliant.

(**) The device orientation is fixed in its embossed tape pocket.

For reverse orientation, please contact your local Torex sales office or representative.

(Standard orientation: R- , Reverse orientation: L-)

(**) USPN-4 (Halogen & Antimony free) is under development.

BLOCK DIAGRAMS

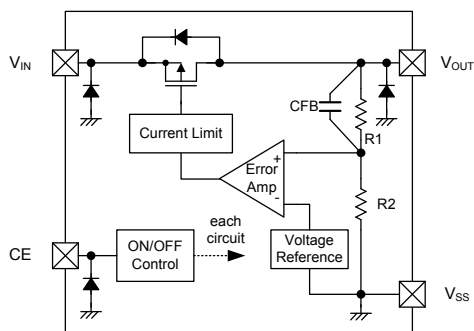

XC6501A Series

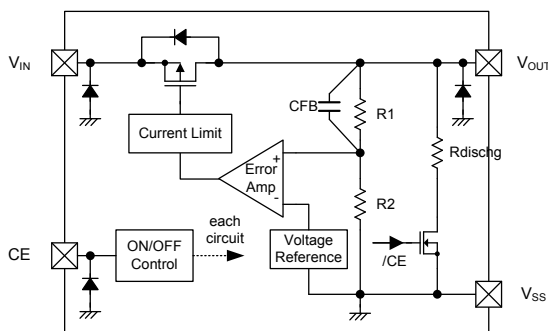

XC6501B Series

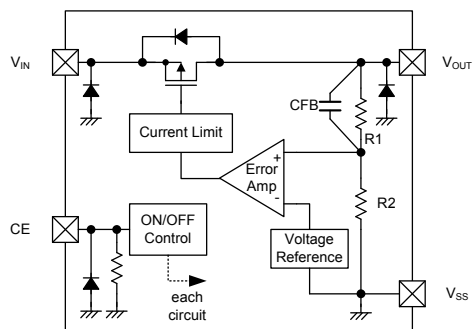

XC6501C Series

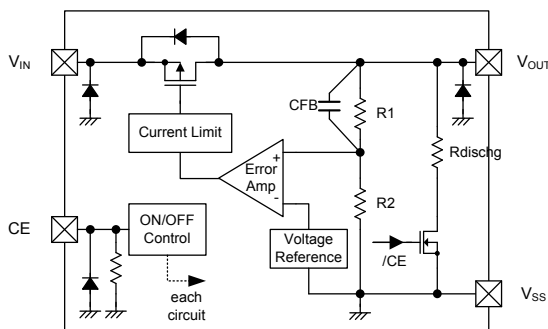

XC6501D Series

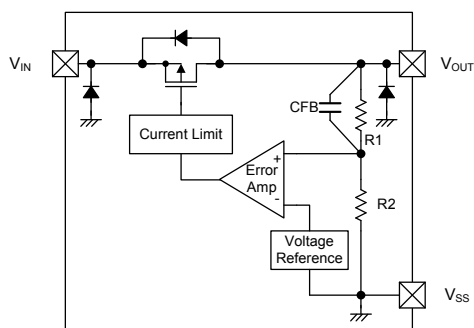

XC6501P Series

*Diodes inside the circuit are an ESD protection diode and a parasitic diode.

ABSOLUTE MAXIMUM RATINGS

PARAMETER	SYMBOL	RATINGS	UNITS
Input Voltage	V_{IN}	$V_{SS}-0.3 \sim +6.5$	V
Output Current	I_{OUT}	400 ^(*)	mA
Output Voltage	V_{OUT}	$V_{SS}-0.3 \sim V_{IN}+0.3$	V
CE Input Voltage	V_{CE}	$V_{SS}-0.3 \sim +6.5$	V
Power Dissipation	Pd	USPN-4 ^(*)	100
		USP-3	120
		USP-4	120
		SSOT-24	150
		SOT-25	250
		600 (PCB mounted) ^(*)	
Operating Temperature Range	T_{opr}	$-40 \sim +85$	
Storage Temperature Range	T_{stg}	$-55 \sim +125$	

*1 $Pd > (V_{IN} - V_{OUT}) \times I_{OUT}$

*2 USP-4 is under development.

*3 The power dissipation figure shown is PCB mounted and is for reference only. Please refer to page 20 for details.

ELECTRICAL CHARACTERISTICS

XC6501 Series

Ta=25°C

PARAMETER	SYMBOL	CONDITIONS	MIN.	TYP.	MAX.	UNITS	CIRCUIT
Output Voltage	V _{OUT(E)} ^(*2)	2.0V > V _{OUT(T)} ^(*3) V _{CE} =V _{IN} , I _{OUT} =10mA	-0.02 ^(*4)	V _{OUT(T)}	+0.02 ^(*4)	V	①
		2.0V ≤ V _{OUT(T)} V _{CE} =V _{IN} , I _{OUT} =10mA	×0.99 ^(*4)		×1.01 ^(*4)		
Maximum Output Current	I _{OUTMAX}	V _{CE} =V _{IN}	200	-	-	mA	①
Load Regulation	ΔV _{OUT}	V _{CE} =V _{IN} , 0.1mA ≤ I _{OUT} ≤ 100mA	-	15	45	mV	①
Dropout Voltage ^(*5)	V _{dif}	V _{CE} =V _{IN} , I _{OUT} =100mA	E-1			mV	①
Supply Current	I _{DD}	V _{IN} =V _{CE} =6.0V, I _{OUT} =0mA	E-2			μA	②
Stand-by Current	I _{stby}	V _{IN} =6.0V, V _{CE} =V _{SS}	-	0.01	0.1	μA	②
Line Regulation	$\frac{\Delta V_{OUT}}{\Delta V_{IN} \cdot V_{OUT}}$	V _{OUT(T)} +0.5V ≤ V _{IN} ≤ 6.0V, V _{CE} =V _{IN} , I _{OUT} =30mA	-	0.10	0.20	%/V	①
Input Voltage	V _{IN}		1.4	-	6.0	V	①
Output Voltage Temperature Characteristics	$\frac{\Delta V_{OUT}}{\Delta T_a \cdot V_{OUT}}$	V _{CE} =V _{IN} , I _{OUT} =30mA -40°C ≤ Ta ≤ 85°C	-	±100	-	ppm/°C	①
Ripple Rejection Rate	PSRR	V _{OUT(T)} ≤ 4.75V V _{IN} = [V _{OUT(T)} +1.0] V _{DC} +0.5V _{p-pAC} V _{CE} =V _{IN} , I _{OUT} =30mA, f=1kHz V _{OUT(T)} ≥ 4.80V V _{IN} =5.75V _{DC} +0.5V _{p-pAC} V _{CE} =V _{IN} , I _{OUT} =30mA, f=1kHz	-	50	-	dB	③
Current Limit	I _{LIM}	V _{CE} =V _{IN}	210	300	-	mA	①
Short Circuit Current	I _{SHORT}	V _{CE} =V _{IN} , V _{OUT} is short-circuited at the V _{SS} level	-	25	-	mA	①
CE High Level Voltage	V _{CEH}		1.0	-	6.0	V	①
CE Low Level Voltage	V _{CEL}		V _{SS}	-	0.25	V	①
CE High Level Current	I _{CEH}	V _{IN} =V _{CE} =6.0V	-0.1	-	0.1	μA	①
		XC6501A/B/P XC6501C/D	3.5	6.0	10		
CE Low Level Current	I _{CEL}	V _{CE} =V _{SS}	-0.1	-	0.1	μA	①
CL Auto-Discharge Resistance ^(*8)	R _{DCHG}	V _{IN} =6.0V, V _{OUT} =1.2V, V _{CE} =V _{SS}	-	250	300	Ω	①
		V _{IN} =6.0V, V _{OUT} =5.0V, V _{CE} =V _{SS}	-	400	480	Ω	

Notes:

- *1: Unless otherwise stated regarding input voltage conditions, V_{IN}=V_{OUT(T)}^(*3)+1.0V.
- *2: V_{OUT(E)}: An actual output voltage when an amply stabilized I_{OUT} (V_{OUT(T)}+1.0V) is input.
- *3: V_{OUT(T)}: Nominal output voltage value
- *4: V_{OUT(E)}: Effective output voltage value
- *5: V_{dif}={V_{IN1}^(*7) - V_{OUT1}^(*6)}
- *6: V_{OUT1}: A voltage equal to 98% of the output voltage when an amply stabilized I_{OUT} (V_{OUT(T)}+1.0V) is input.
- *7: V_{IN1}: The input voltage when V_{OUT1} appears as input voltage is gradually decreased.
- *8: This function is built in the XC6501B/D series only.
The XC6501A/C series discharges by resistors R1+ R2 only as shown in the block diagrams.

ELECTRICAL CHARACTERISTICS (Continued)

Voltage Chart

NOMINAL VOLTAGE (V)	E-0		E-1		E-2			
	OUTPUT VOLTAGE (V)		DROPOUT VOLTAGE (mV)		SUPPLY CURRENT (μ A)			
	$V_{OUT(E)}$		V_{dif}		I_{SS}			
$V_{OUT(T)}$	MIN.	MAX.	TYP.	MAX.	TYP.	MAX.		
1.20	1.1800	1.2200	440	690	11	17		
1.25	1.2300	1.2700						
1.30	1.2800	1.3200						
1.35	1.3300	1.3700						
1.40	1.3800	1.4200	300	610				
1.45	1.4300	1.4700						
1.50	1.4800	1.5200						
1.55	1.5300	1.5700						
1.60	1.5800	1.6200	260	530				
1.65	1.6300	1.6700						
1.70	1.6800	1.7200						
1.75	1.7300	1.7700						
1.80	1.7800	1.8200	230	470	12	18		
1.85	1.8300	1.8700						
1.90	1.8800	1.9200						
1.95	1.9300	1.9700						
2.00	1.9800	2.0200	200	430				
2.05	2.0295	2.0705						
2.10	2.0790	2.1210						
2.15	2.1285	2.1715						
2.20	2.1780	2.2220	190	410			13	19
2.25	2.2275	2.2725						
2.30	2.2770	2.3230						
2.35	2.3265	2.3735						
2.40	2.3760	2.4240	210	380				
2.45	2.4255	2.4745						
2.50	2.4750	2.5250						
2.55	2.5245	2.5755						
2.60	2.5740	2.6260	150	360	20	20		
2.65	2.6235	2.6765						
2.70	2.6730	2.7270						
2.75	2.7225	2.7775						
2.80	2.7720	2.8280	150	360				
2.85	2.8215	2.8785						
2.90	2.8710	2.9290						
2.95	2.9205	2.9795						

ELECTRICAL CHARACTERISTICS (Continued)

Voltage Table (continued)

NOMINAL VOLTAGE (V)	E-0		E-1		E-2	
	OUTPUT VOLTAGE (V)		DROPOUT VOLTAGE (mV)		SUPPLY CURRENT (μ A)	
	$V_{OUT(E)}$		V_{dif}		I_{SS}	
$V_{OUT(T)}$	MIN.	MAX.	TYP.	MAX.	TYP.	MAX.
3.00	2.9700	3.0300	150	360	14	20
3.05	3.0195	3.0805				
3.10	3.0690	3.1310				
3.15	3.1185	3.1815				
3.20	3.1680	3.2320	140	350	21	
3.25	3.2175	3.2825				
3.30	3.2670	3.3330				
3.35	3.3165	3.3835				
3.40	3.3660	3.4340				
3.45	3.4155	3.4845				
3.50	3.4650	3.5350				
3.55	3.5145	3.5855				
3.60	3.5640	3.6360	130	340	15	
3.65	3.6135	3.6865				
3.70	3.6630	3.7370				
3.75	3.7125	3.7875				
3.80	3.7620	3.8380				
3.85	3.8115	3.8885				
3.90	3.8610	3.9390				
3.95	3.9105	3.9895				
4.00	3.9600	4.0400	120	330	16	
4.05	4.0095	4.0905				
4.10	4.0590	4.1410				
4.15	4.1085	4.1915				
4.20	4.1580	4.2420				
4.25	4.2075	4.2925				
4.30	4.2570	4.3430				
4.35	4.3065	4.3935				
4.40	4.3560	4.4440	22	23		
4.45	4.4055	4.4945				
4.50	4.4550	4.5450				
4.55	4.5045	4.5955				
4.60	4.5540	4.6460				
4.65	4.6035	4.6965				
4.70	4.6530	4.7470				
4.75	4.7025	4.7975				
4.80	4.7520	4.8480	23	23		
4.85	4.8015	4.8985				
4.90	4.8510	4.9490				
4.95	4.9005	4.9995				
5.00	4.9500	5.0500				

OPERATIONAL EXPLANATION

The voltage divided by resistors R1 & R2 is compared with the internal reference voltage by the error amplifier. The P-channel MOSFET which is connected to the V_{OUT} pin is then driven by the subsequent output signal. The output voltage at the V_{OUT} pin is controlled & stabilized by a system of negative feedback. The current limit circuit and short protect circuit operate in relation to the level of output current. Further, the IC's internal circuitry can be shutdown via the CE pin's signal.

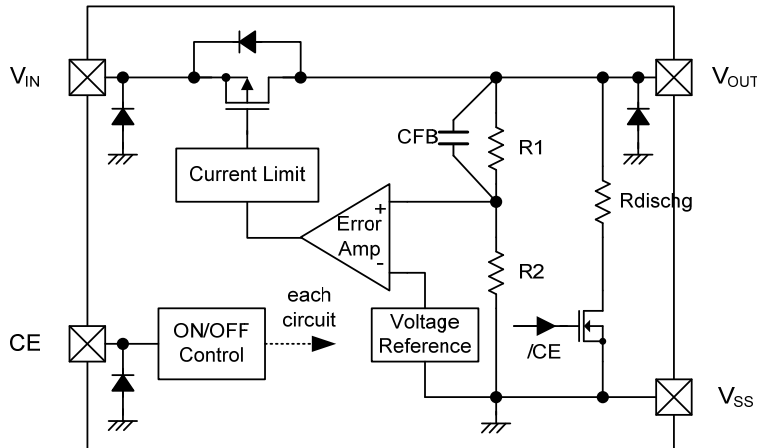

XC6501B Series

< C_L High Speed Auto-Discharge Function>

The XC6501B/D series can discharge the electric charge in the output capacitor C_L , when a low signal to the CE pin, which enables a whole IC circuit turn off, is inputted via the N-channel transistor located between the V_{OUT} pin and the V_{SS} pin as shown in the BLOCK DIAGRAM. The C_L auto-discharge resistance value is set at 400 ($V_{OUT}=5.0V$ @ $V_{IN}=6.0V$ at typical). The discharge time of the output capacitor C_L is set by the C_L auto-discharge resistance R and the output capacitor C_L . By setting time constant of a C_L auto-discharge resistance value Rdischg and an output capacitor value C_L as τ ($\tau = C \times Rdischg$), the output voltage after discharge via the N-channel transistor is calculated by the following formulas.

$$V = V_{OUT(E)} \times e^{-t/\tau}, \text{ or } t = \tau \times \ln(V_{OUT(E)} / V)$$

where V : Output voltage after discharge, $V_{OUT(E)}$: Output voltage, t : Discharge time,

τ : C_L auto-discharge resistance Rdischg x Output capacitor C_L

<Current Limiter, Short-Circuit Protection>

The XC6501 series' fold-back circuit operates as an output current limiter and a short protection of the output pin. When the load current reaches the current limit level, the fixed current limiter circuit operates and output voltage drops. When the output voltage is shorted to the V_{SS} , its current flow reached and minimized to about 25mA.

<CE Pin>

The IC's internal circuitry can be shutdown via the signal from the CE pin with the XC6501 series. In shutdown mode output at the V_{OUT} pin will be pulled down to the V_{SS} level via R1 & R2. However, as for the XC6501B/D series, the C_L auto-discharge resistor is connected in parallel to R1 and R2 while the power supply is applied to the V_{IN} pin. Therefore, time until the V_{OUT} pin reaches the V_{SS} level becomes short. The output voltage becomes unstable, when the CE pin is open. If this IC is used with the correct output voltage for the CE pin, the logic is fixed and the IC will operate normally. However, supply current may increase as a result of through current in the IC's internal circuitry when medium voltage is input.

NOTES ON USE

1. Please use this IC within the stated absolute maximum ratings. The IC is liable to malfunction should the ratings be exceeded.
2. This IC achieves stable operation without an output capacitor C_L by internal phase compensation. However, wiring impedance is high, operations may become unstable due to noise and/or phase lag depending on output current. Please wire the input capacitor C_{IN} and the output capacitor C_L as close to the IC as possible.

TEST CIRCUITS

Circuit

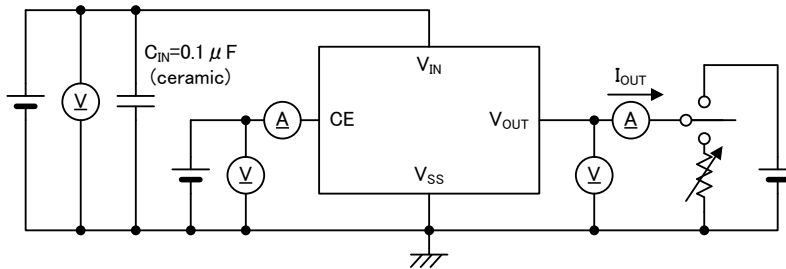

Circuit

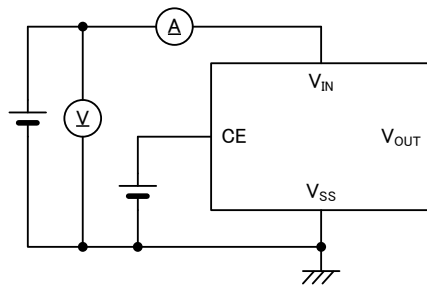

Circuit

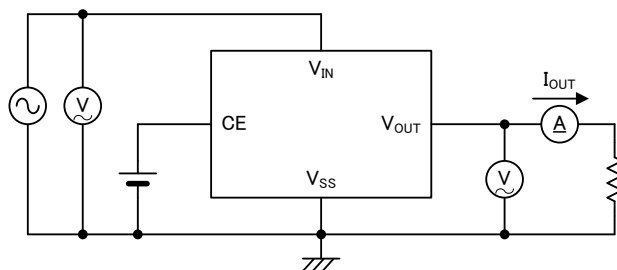

TYPICAL PERFORMANCE CHARACTERISTICS

*CE Voltage condition: Unless otherwise stated, $V_{CE} = V_{IN}$

(1) Output Voltage vs. Output Current

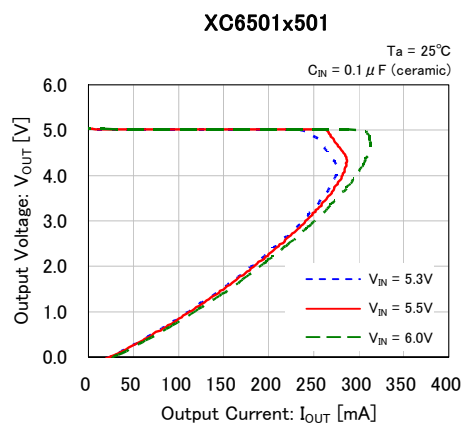
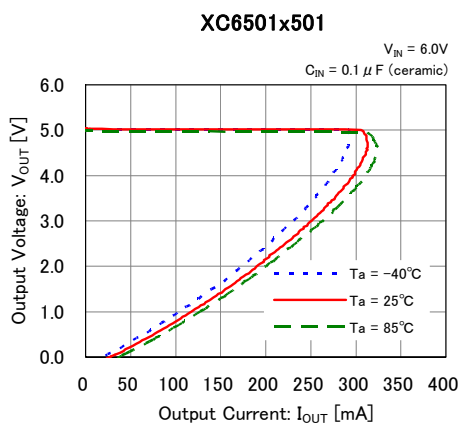
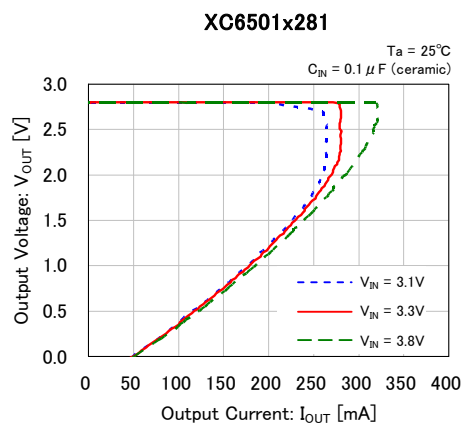
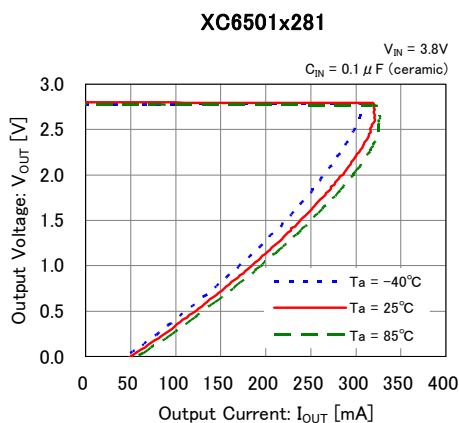
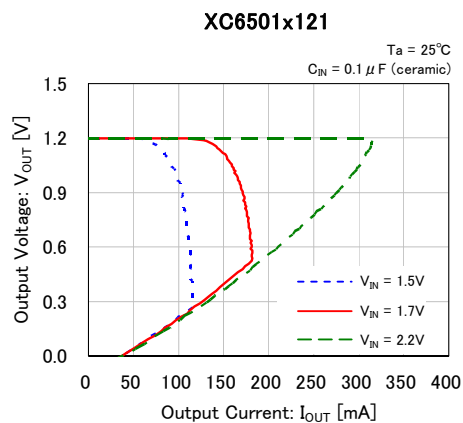
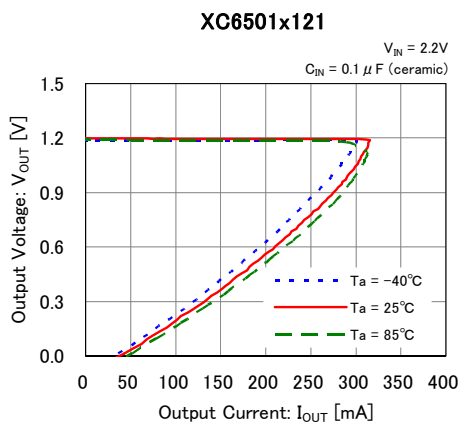

TYPICAL PERFORMANCE CHARACTERISTICS (Continued)

(2) Output Voltage vs. Input Voltage

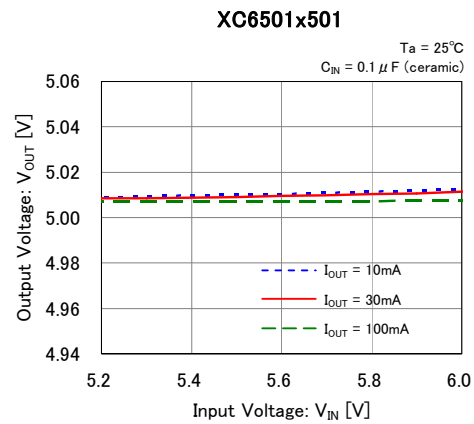
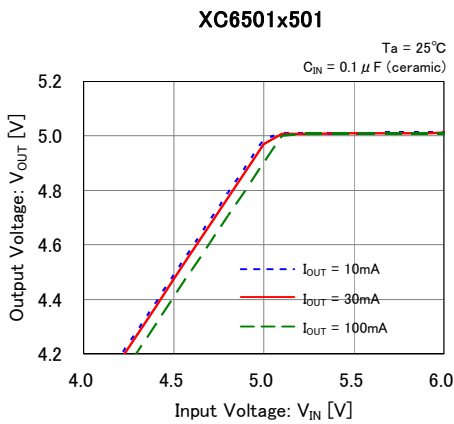
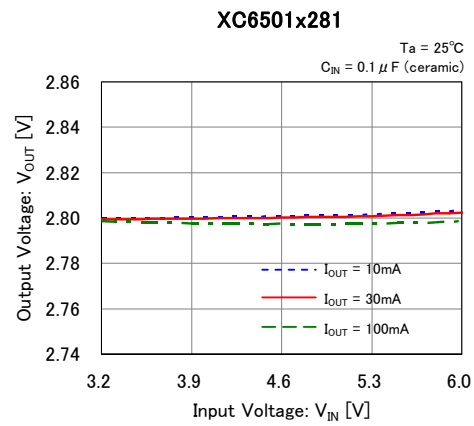
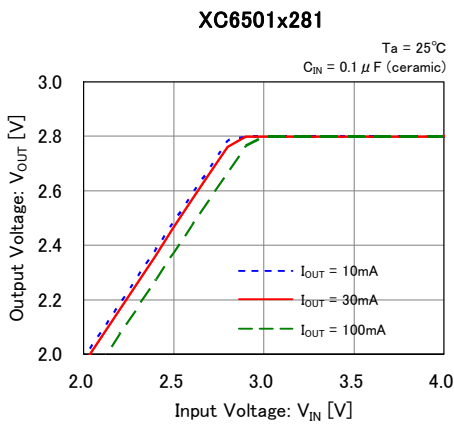
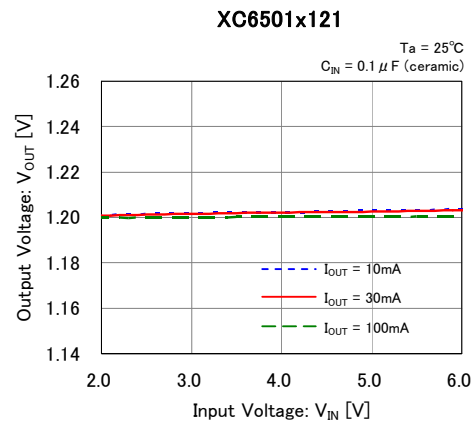
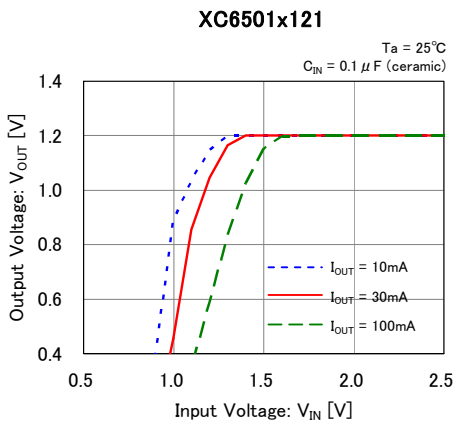

TYPICAL PERFORMANCE CHARACTERISTICS (Continued)

(3) Dropout Voltage vs. Output Current

XC6501x121

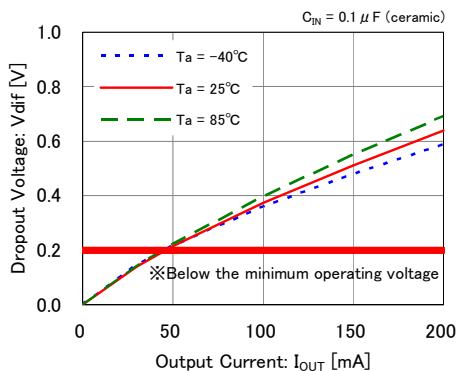

XC6501x281

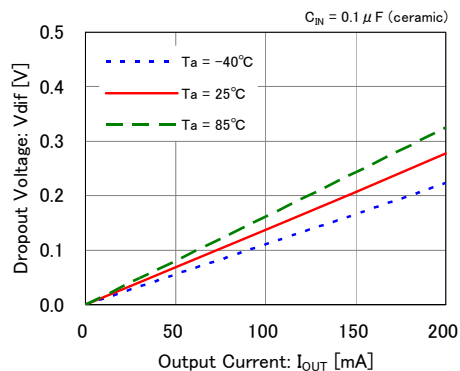

(4) Supply Current vs. Input Voltage

XC6501x501

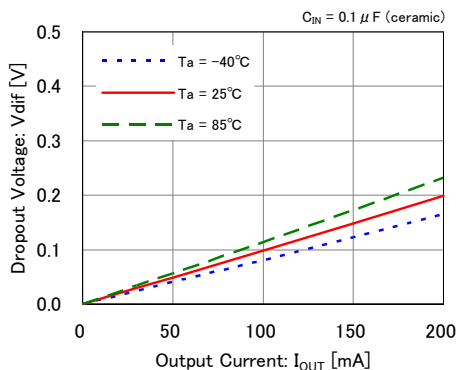

XC6501x121

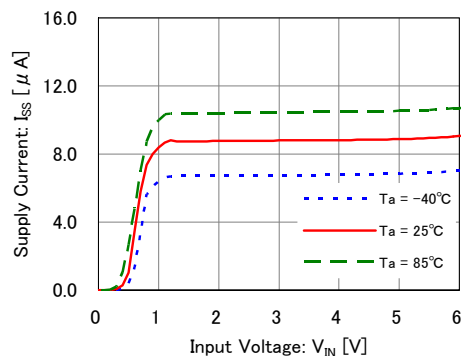

XC6501x281

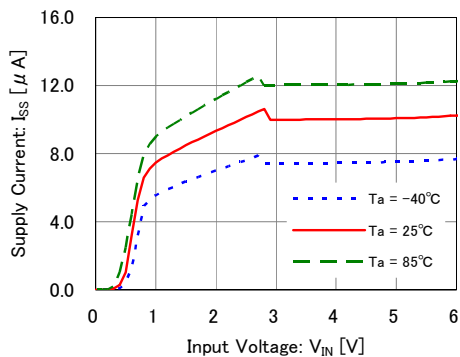

XC6501x501

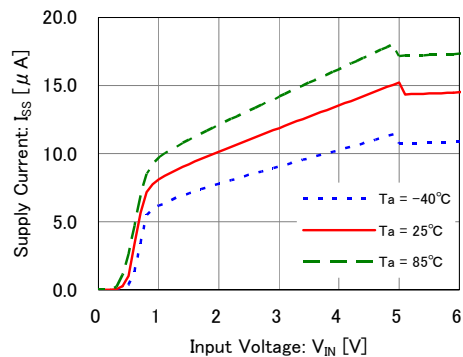

TYPICAL PERFORMANCE CHARACTERISTICS (Continued)

(5) Output Voltage vs. Ambient Temperature

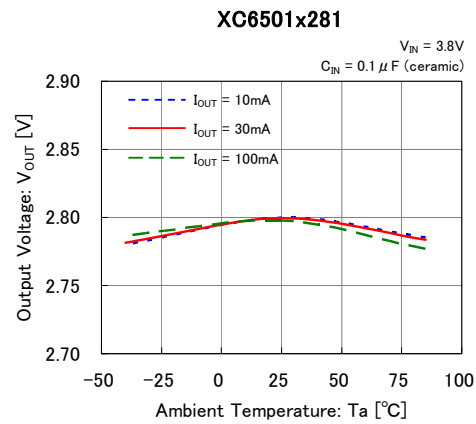
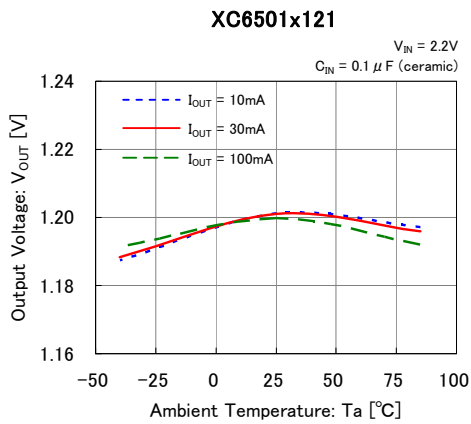

(6) Supply Current vs. Ambient Temperature

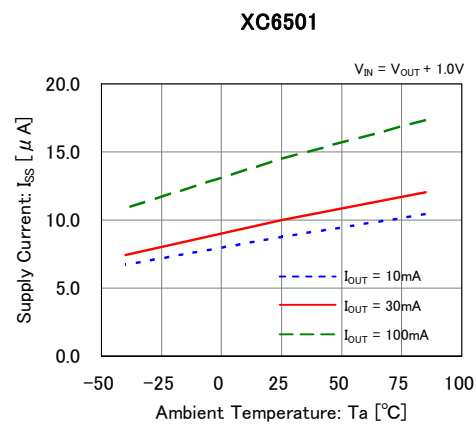
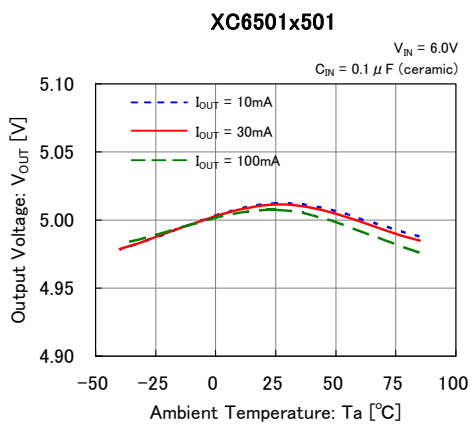

(7) CE Threshold Voltage vs. Ambient Temperature

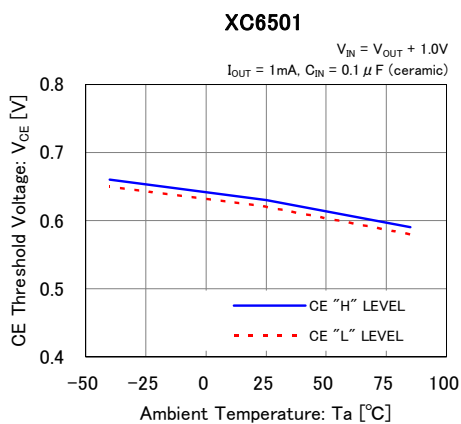

TYPICAL PERFORMANCE CHARACTERISTICS (Continued)

(8) Rising Response Time

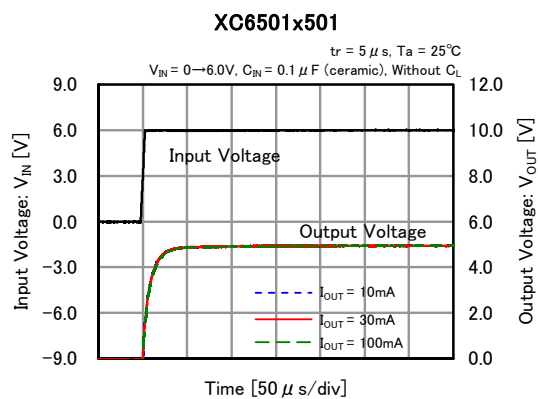
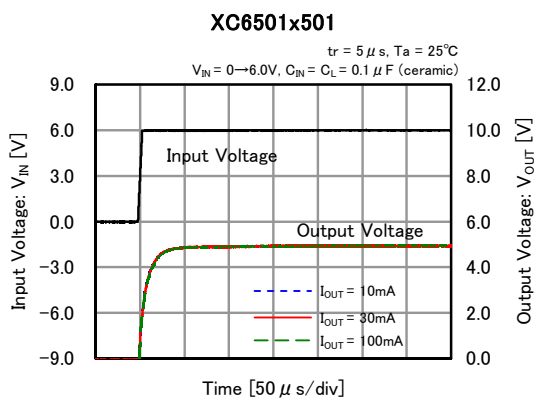
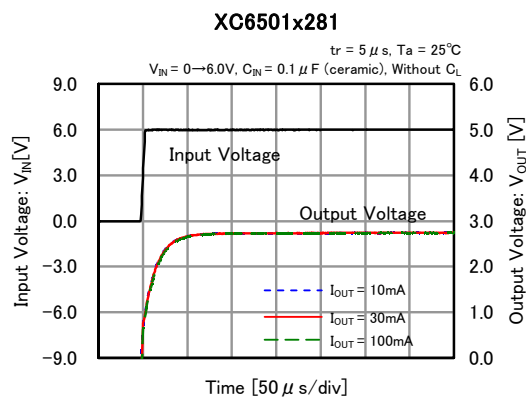
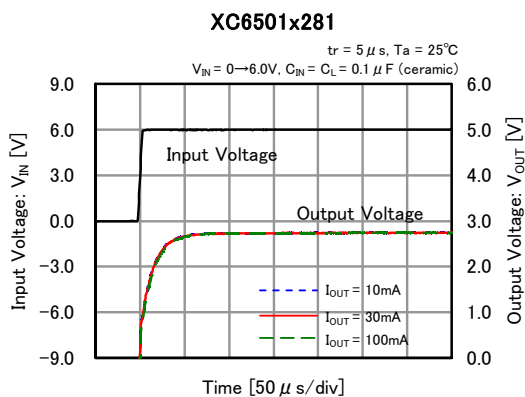
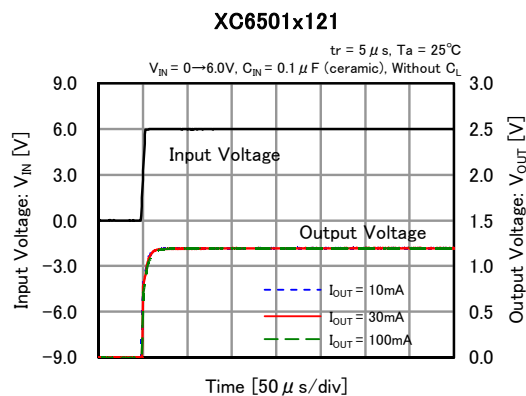
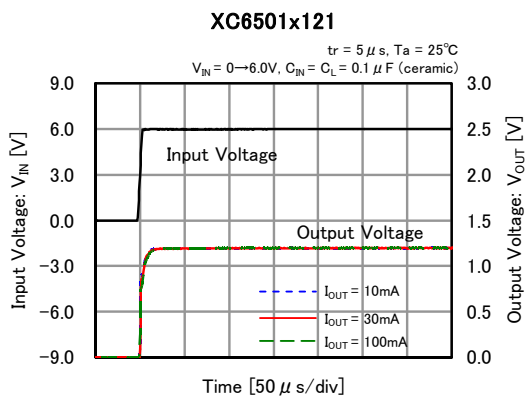

TYPICAL PERFORMANCE CHARACTERISTICS (Continued)

(9) Input Transient Response

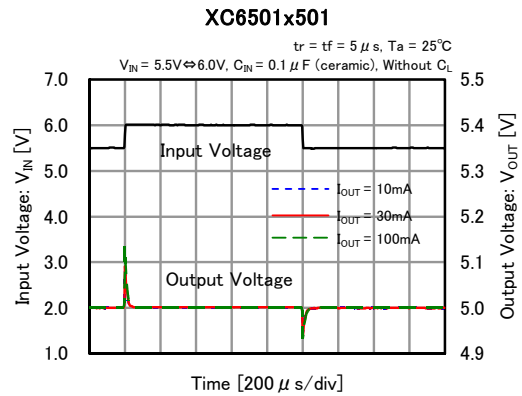
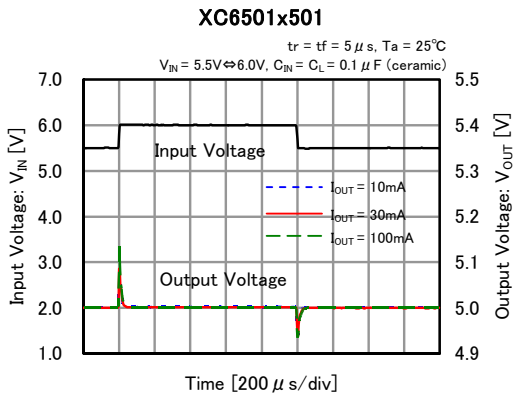
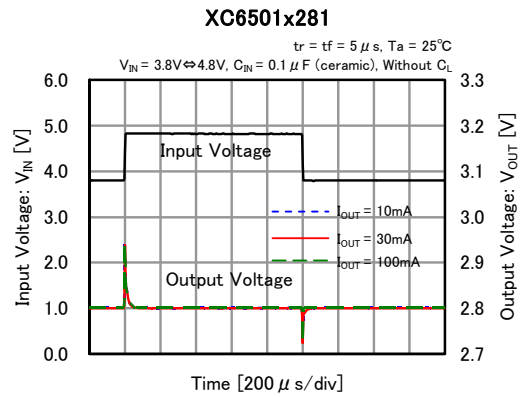
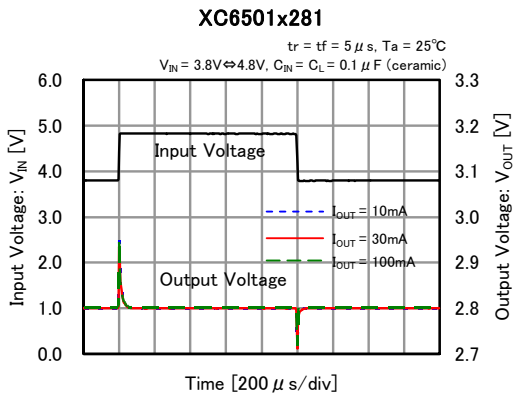
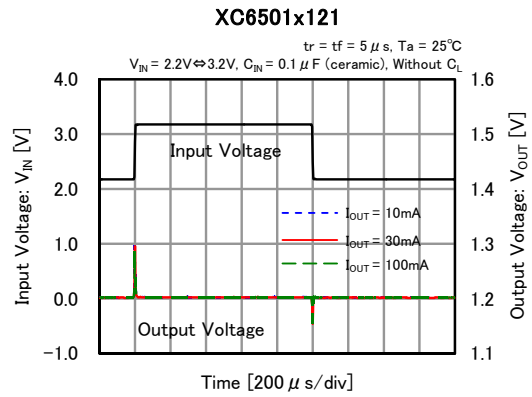
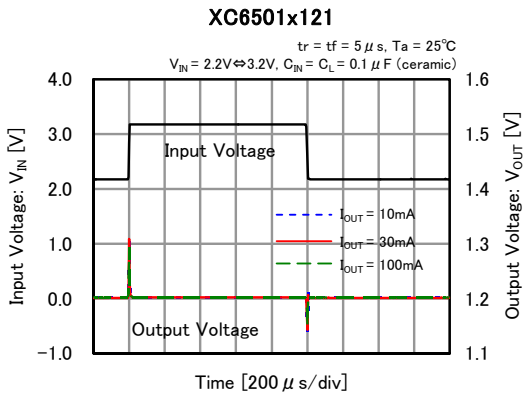

TYPICAL PERFORMANCE CHARACTERISTICS (Continued)

(10) Load Transient Response

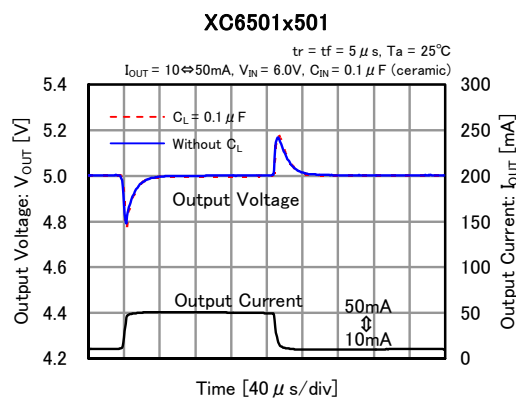
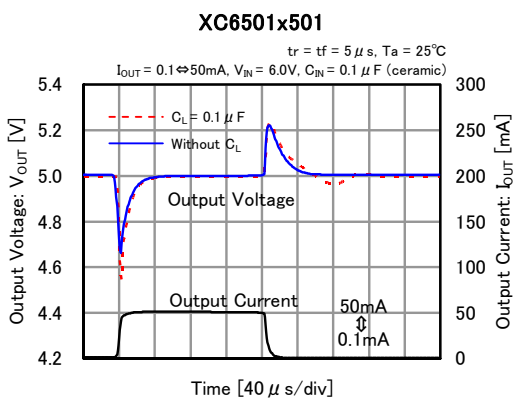
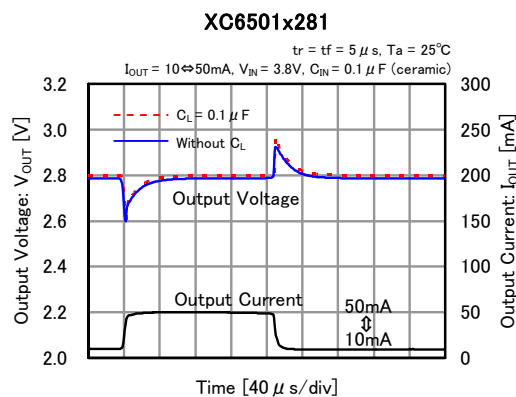
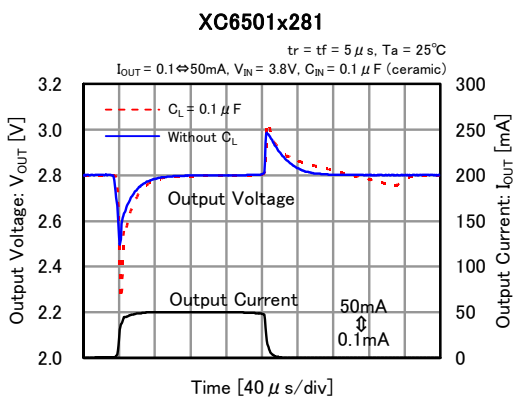
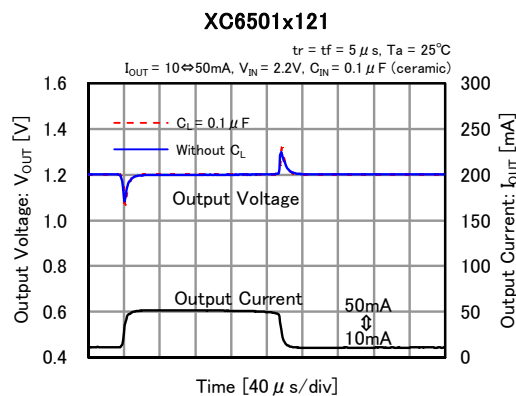
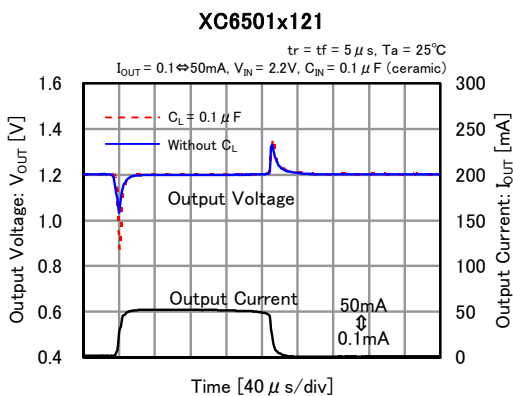

TYPICAL PERFORMANCE CHARACTERISTICS (Continued)

(11) CE Rising Respose Time

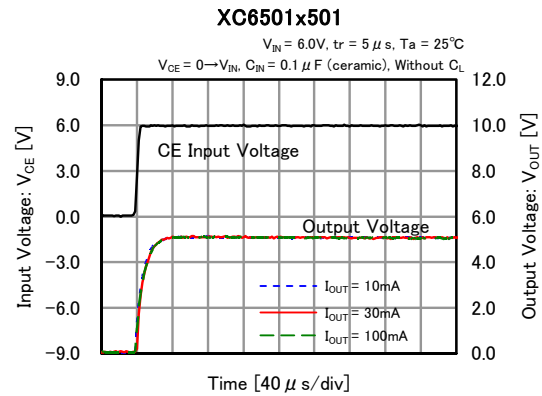
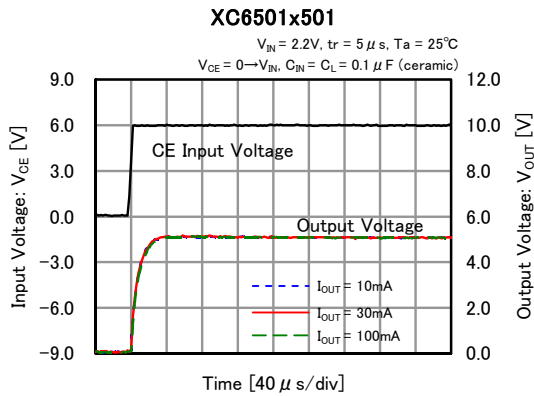
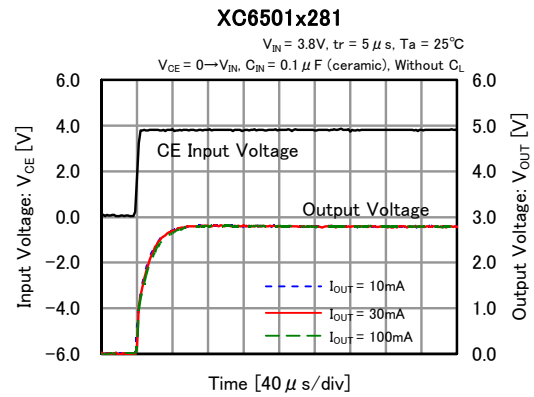
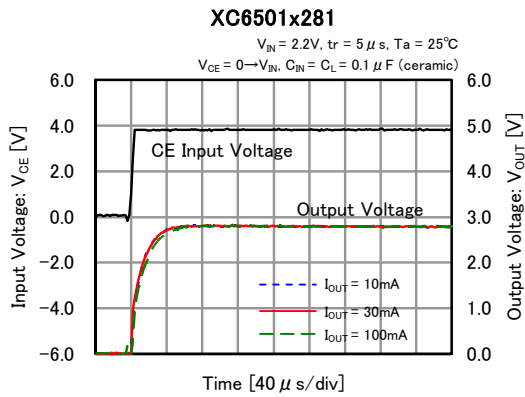
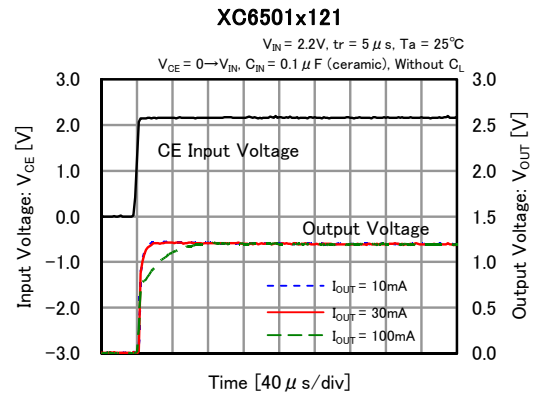
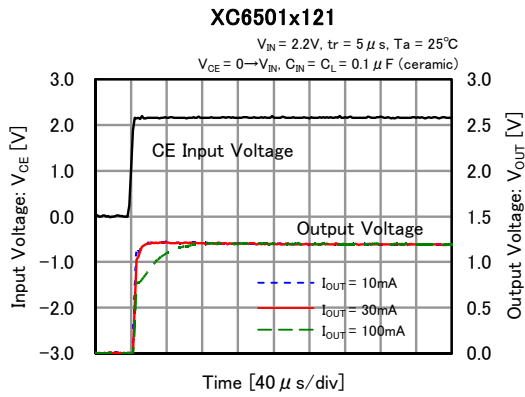

TYPICAL PERFORMANCE CHARACTERISTICS (Continued)

(12) Ripple Rejection Rate

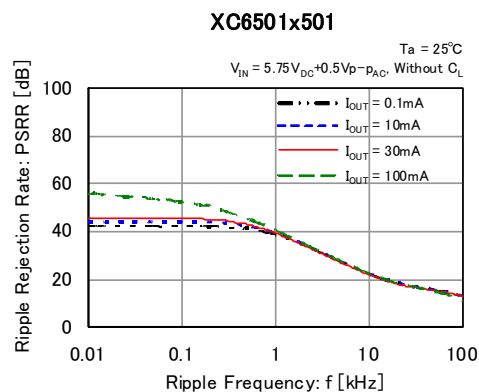
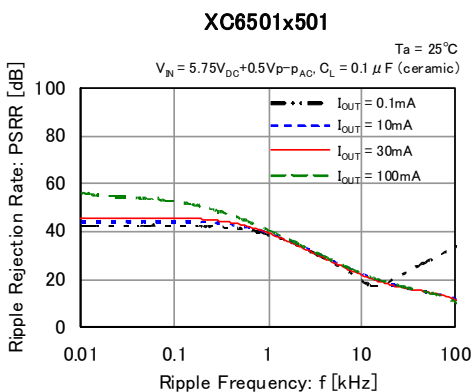
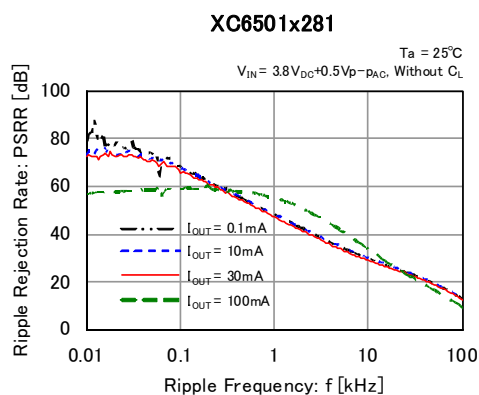
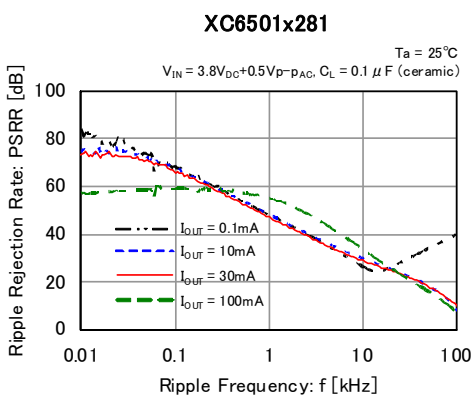
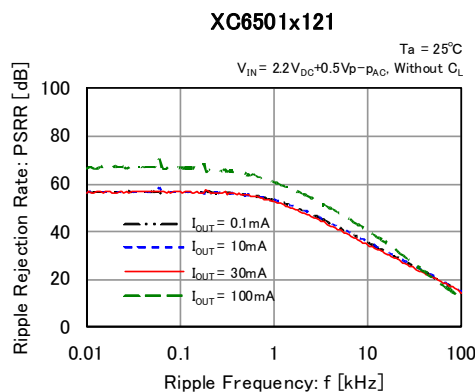
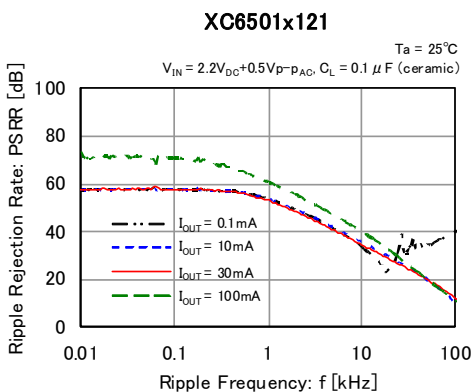

PACKAGING INFORMATION

● USP-3

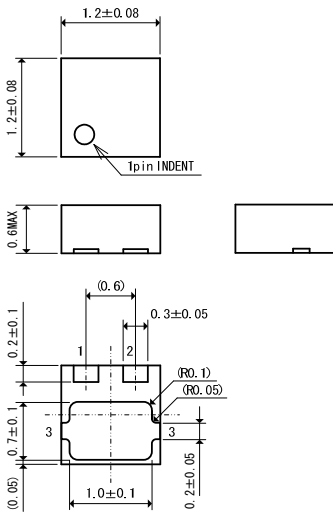

● USP-4

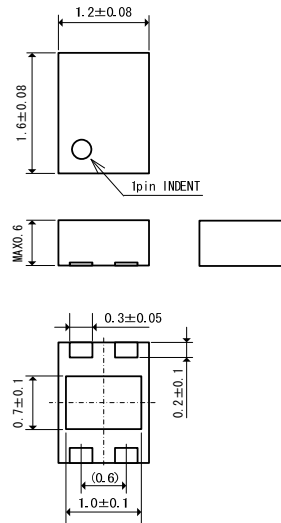

● SSOT-24

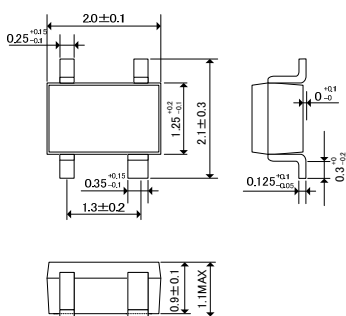

● SOT-25

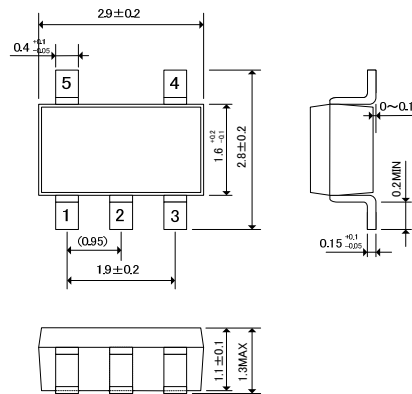

● USPN-4

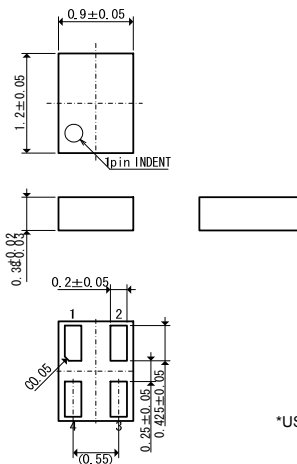

*USPN-4 is under development.

PACKAGING INFORMATION (Continued)

USP-3 Reference Pattern Layout

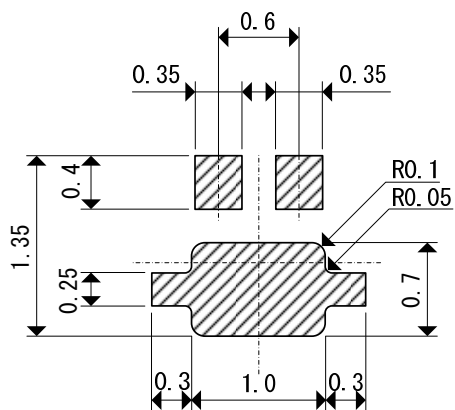

USP-3 Reference Metal Mask Design

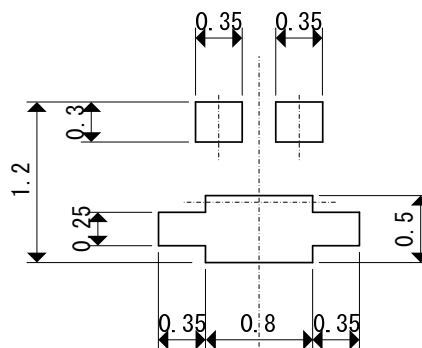

USP-4 Reference Pattern Layout

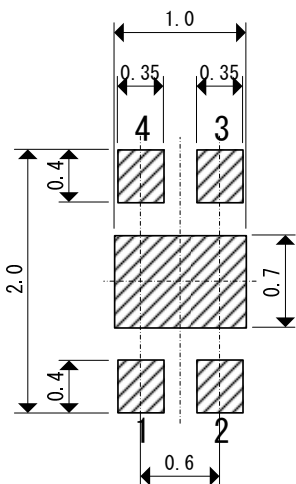

USP-4 Reference Metal Mask Design

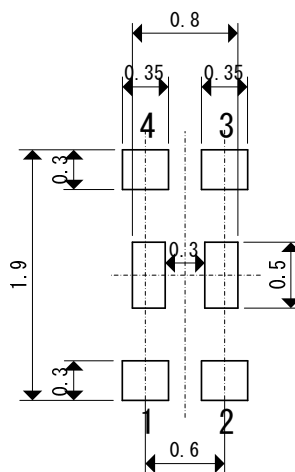

USPN-4 Reference Pattern Layout

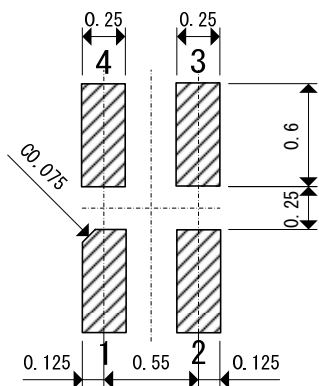

USPN-4 Reference Metal Mask Design

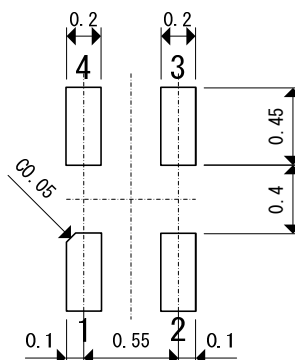

*USPN-4 is under development.

PACKAGING INFORMATION (Continued)

SOT-25 Power Dissipation

Power dissipation data for the SOT-25 is shown in this page.
The value of power dissipation varies with the mount board conditions.
Please use this data as one of reference data taken in the described condition.

1. Measurement Condition (Reference data)

- Condition: Mount on a board
- Ambient: Natural convection
- Soldering: Lead (Pb) free
- Board: Dimensions 40 x 40 mm (1600 mm² in one side)
Copper (Cu) traces occupy 50% of the board area
In top and back faces
Package heat-sink is tied to the copper traces
(Board of SOT-26 is used.)
- Material: Glass Epoxy (FR-4)
- Thickness: 1.6 mm
- Through-hole: 4 x 0.8 Diameter

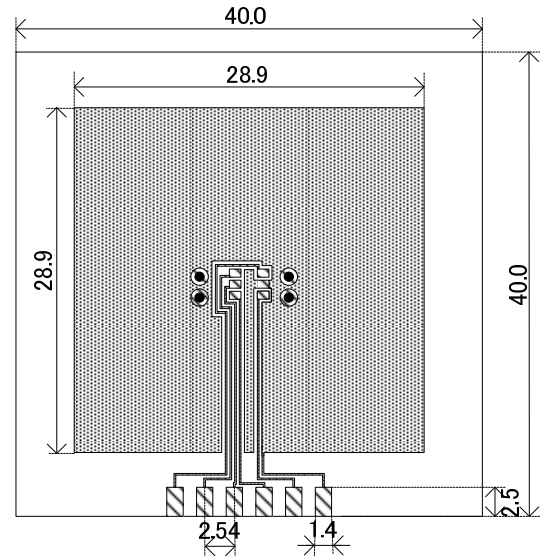

Evaluation Board (Unit: mm)

2. Power Dissipation vs. Operating temperature

Board Mount ($T_j \text{ max} = 125$)

Ambient Temperature (°C)	Power Dissipation Pd (mW)	Thermal Resistance (°C/W)
25	600	166.67
85	240	

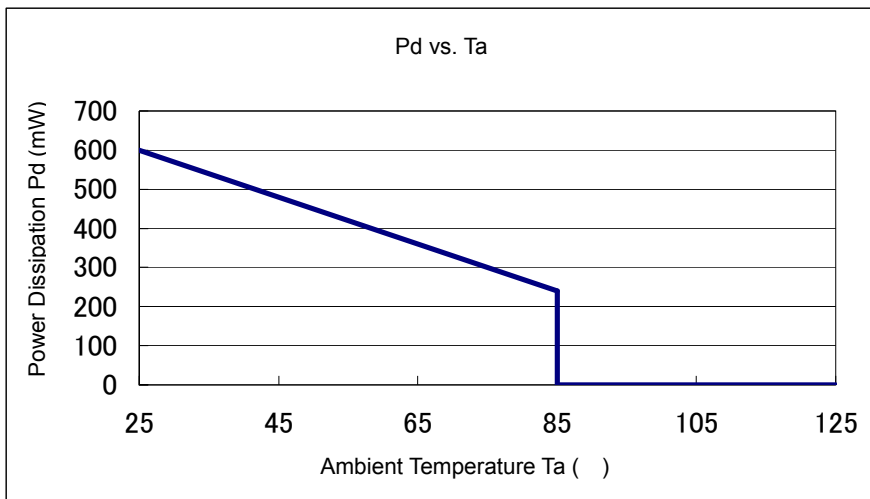

1. The products and product specifications contained herein are subject to change without notice to improve performance characteristics. Consult us, or our representatives before use, to confirm that the information in this datasheet is up to date.
2. We assume no responsibility for any infringement of patents, patent rights, or other rights arising from the use of any information and circuitry in this datasheet.
3. Please ensure suitable shipping controls (including fail-safe designs and aging protection) are in force for equipment employing products listed in this datasheet.
4. The products in this datasheet are not developed, designed, or approved for use with such equipment whose failure or malfunction can be reasonably expected to directly endanger the life of, or cause significant injury to, the user.
(e.g. Atomic energy; aerospace; transport; combustion and associated safety equipment thereof.)
5. Please use the products listed in this datasheet within the specified ranges.
Should you wish to use the products under conditions exceeding the specifications, please consult us or our representatives.
6. We assume no responsibility for damage or loss due to abnormal use.
7. All rights reserved. No part of this datasheet may be copied or reproduced without the prior permission of TOREX SEMICONDUCTOR LTD.

TOREX SEMICONDUCTOR LTD.