

# Kingbright®

## 38mm (1.5 INCH) SINGLE DIGIT NUMERIC DISPLAYS

SA15-11  
SBA15-11

SC15-11  
SBC15-11

### Features

- 1.5INCHDIGITHEIGHT.
- LOW CURRENT OPERATION.
- EXCELLENT CHARACTER APPEARANCE.
- HIGH LIGHT OUTPUT.
- EASY MOUNTING ON P.C. BOARDS OR SOCKETS.
- I.C. COMPATIBLE.
- MULTICOLOR AVAILABLE.
- CATEGORIZED FOR LUMINOUS INTENSITY,  
YELLOW AND GREEN CATEGORIZED FOR COLOR.
- MECHANICALLY RUGGED.
- STANDARD : GRAY FACE, WHITE SEGMENT.

### Description

The Bright Red source color devices are made with Gallium Phosphide Red Light Emitting Diode.

The Green source color devices are made with Gallium Phosphide Green Light Emitting Diode.

The High Efficiency Red source color devices are made with Gallium Arsenide Phosphide on Gallium Phosphide Orange Light Emitting Diode.

The Yellow source color devices are made with Gallium Arsenide Phosphide on Gallium Phosphide Yellow Light Emitting Diode.

The Super Bright Red source color devices are made with Gallium Aluminum Arsenide Red Light Emitting Diode .

### Package Dimensions

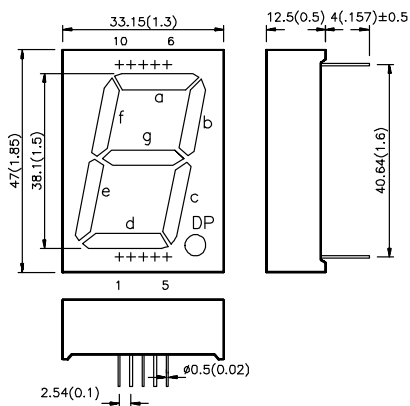

### Internal Circuit Diagram

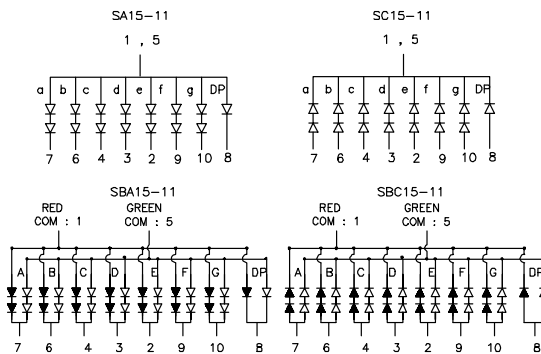

### Notes:

1. All dimensions are in millimeters (inches). Tolerance is  $\pm 0.25(0.01)$  mm unless otherwise noted.
2. Specifications are subjected to change without notice.

### Selection Guide

| Part No.     | Dice                            | Iv (ucd)<br>@ 10 mA |       | Description                      |
|--------------|---------------------------------|---------------------|-------|----------------------------------|
|              |                                 | Min.                | Max.  |                                  |
| SA15-11HWA   | BRIGHT RED (GaP)                | 900                 | 2200  | Common Anode, Rt Hand Decimal    |
| SC15-11HWA   |                                 |                     |       | Common Cathode, Rt. Hand Decimal |
| SA15-11EWA   | HIGH EFFICIENCY RED (GaAsP/GaP) | 3600                | 21000 | Common Anode, Rt Hand Decimal    |
| SC15-11EWA   |                                 |                     |       | Common Cathode, Rt. Hand Decimal |
| SA15-11GWA   | GREEN (GaP)                     | 3600                | 9000  | Common Anode, Rt Hand Decimal    |
| SC15-11GWA   |                                 |                     |       | Common Cathode, Rt. Hand Decimal |
| SA15-11YWA   | YELLOW (GaAsP/GaP)              | 3600                | 9000  | Common Anode, Rt Hand Decimal    |
| SC15-11YWA   |                                 |                     |       | Common Cathode, Rt. Hand Decimal |
| SA15-11SRWA  | SUPER BRIGHT RED (GaAlAs)       | 14000               | 31000 | Common Anode, Rt Hand Decimal    |
| SC15-11SRWA  |                                 |                     |       | Common Cathode, Rt. Hand Decimal |
| SBA15-11EGWA | HIGH EFFICIENCY RED (GaAsP/GaP) | 3600                | 21000 | Common Anode, Rt Hand Decimal    |
| SBC15-11EGWA | GREEN (GaP)                     | 3600                | 9000  | Common Cathode, Rt. Hand Decimal |

### Electrical / Optical Characteristics at T<sub>A</sub>=25°C

| Symbol                  | Parameter               | Device   | Typ.                             | Max.                            | Units | Test Conditions |
|-------------------------|-------------------------|--|----------------------------------|---------------------------------|-------|-----------------|
| $\lambda_{\text{peak}}$ | Peak Wavelength         | Bright Red<br>High Efficiency Red<br>Green<br>Yellow<br>Super Bright Red | 700<br>625<br>565<br>590<br>660  |                                 | nm    | IF=20mA         |
| $\Delta\lambda_{1/2}$   | Spectral Line Halfwidth | Bright Red<br>High Efficiency Red<br>Green<br>Yellow<br>Super Bright Red | 45<br>45<br>30<br>35<br>20       |                                 | nm    | IF=20mA         |
| C                       | Capacitance             | Bright Red<br>High Efficiency Red<br>Green<br>Yellow<br>Super Bright Red | 40<br>12<br>45<br>10<br>95       |                                 | pF    | VF=0V;f=1MHz    |
| V <sub>F</sub>          | Forward Voltage         | Bright Red<br>High Efficiency Red<br>Green<br>Yellow<br>Super Bright Red | 2.0<br>2.0<br>2.2<br>2.1<br>1.85 | 2.5<br>2.5<br>2.5<br>2.5<br>2.5 | V     | IF=20mA         |
| I <sub>R</sub>          | Reverse Current         | All  | 10                               |                                 | uA    | VR = 5V         |

Absolute Maximum Ratings at  $T_A=25^\circ\text{C}$

| Parameter                      | Bright Red           | High Efficiency Red | Green | Yellow | Super Bright Red | Units |
|--------------------------------|----------------------|---------------------|-------|--------|------------------|-------|
| Power dissipation              | 120                  | 105                 | 105   | 105    | 100              | mW    |
| DC Forward Current             | 25                   | 30                  | 25    | 30     | 30               | mA    |
| Peak Forward Current [1]       | 150                  | 150                 | 150   | 150    | 150              | mA    |
| Reverse Voltage                | 5                    | 5                   | 5     | 5      | 5                | V     |
| Operating/Storage Temperature  | -40 °C To +85 °C     |                     |       |        |                  |       |
| Lead Soldering Temperature [2] | 260 °C For 5 Seconds |                     |       |        |                  |       |

Notes:  
 1. 1/10 Duty Cycle, 0.1ms Pulse Width.  
 2. 4mm below package base.

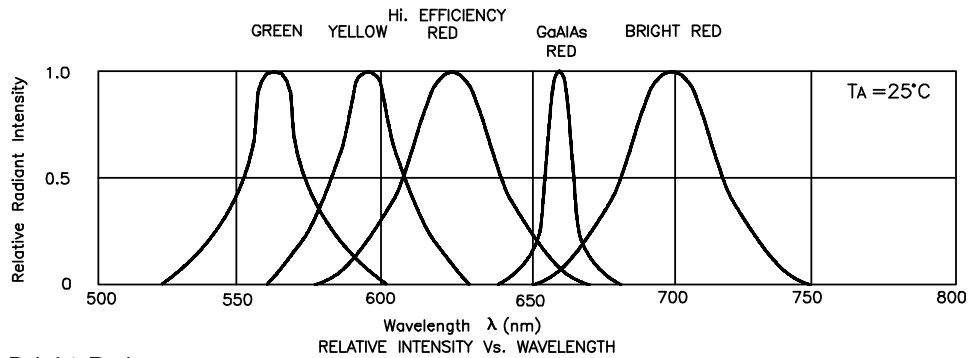

Bright Red

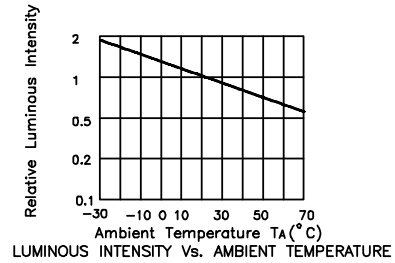
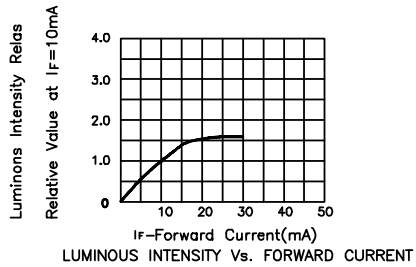
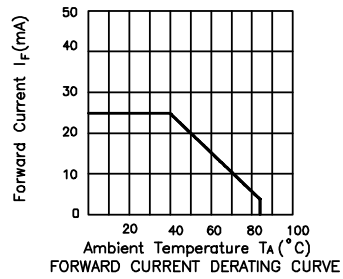
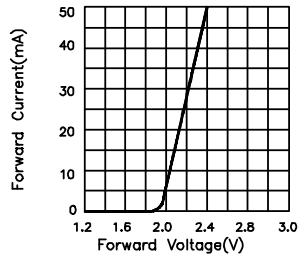

### High Efficiency Red

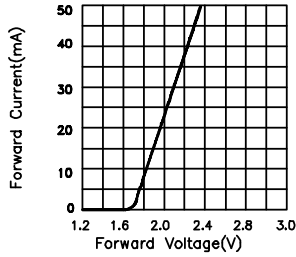

FORWARD CURRENT Vs. FORWARD VOLTAGE

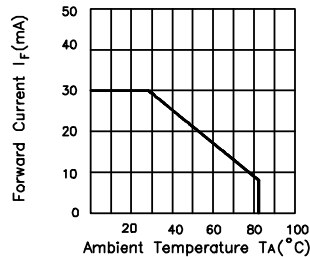

FORWARD CURRENT DERATING CURVE

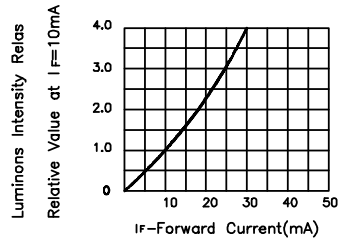

LUMINOUS INTENSITY Vs. FORWARD CURRENT

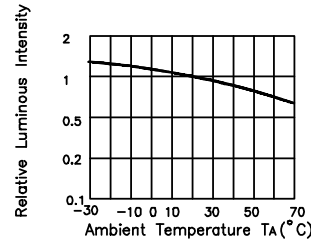

LUMINOUS INTENSITY Vs. AMBIENT TEMPERATURE

### Green

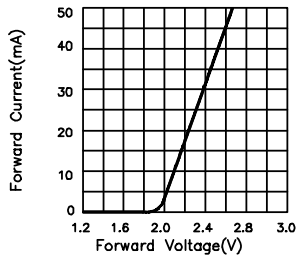

FORWARD CURRENT Vs. FORWARD VOLTAGE

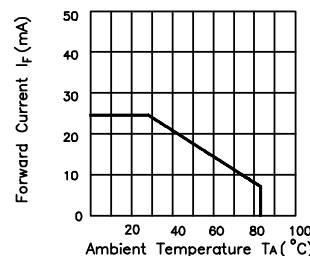

FORWARD CURRENT DERATING CURVE

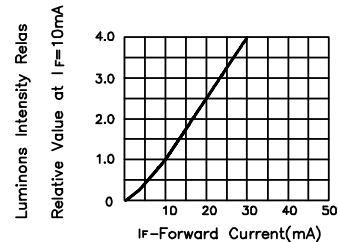

LUMINOUS INTENSITY Vs. FORWARD CURRENT

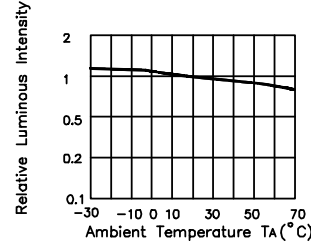

LUMINOUS INTENSITY Vs. AMBIENT TEMPERATURE

## Yellow

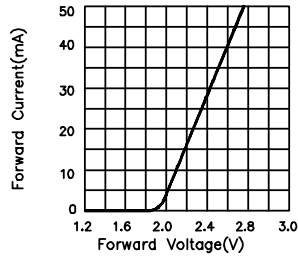

FORWARD CURRENT Vs. FORWARD VOLTAGE

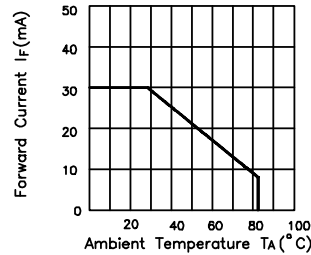

FORWARD CURRENT DERATING CURVE

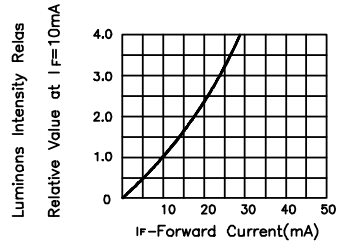

LUMINOUS INTENSITY Vs. FORWARD CURRENT

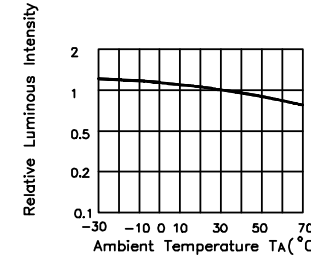

LUMINOUS INTENSITY Vs. AMBIENT TEMPERATURE

## Super Bright Red

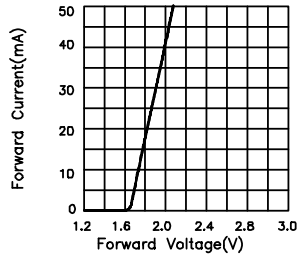

FORWARD CURRENT Vs. FORWARD VOLTAGE

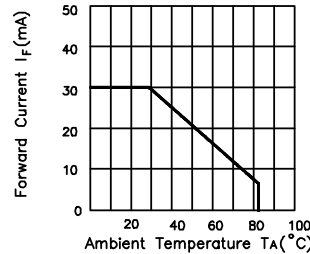

FORWARD CURRENT DERATING CURVE

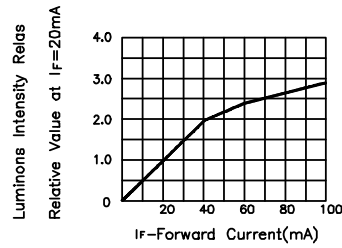

LUMINOUS INTENSITY Vs. FORWARD CURRENT

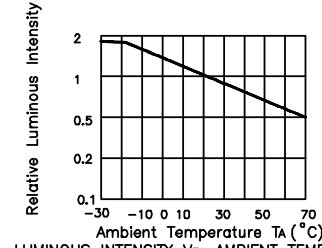

LUMINOUS INTENSITY Vs. AMBIENT TEMPERATURE