

XC6202 Series



High Voltage Positive Voltage Regulators

- ◆ CMOS Low Power Consumption
- ◆ Operational Voltage Range : Up to 20V
- ◆ Dropout Voltage : 200mV@30mA
670mV@100mA
- ◆ Maximum Output Current : More Than 150mA
- ◆ Highly Accurate : $\pm 2\%$
- ◆ Output Voltage Range : 1.8V ~ 18.0V
- ◆ Current Limiter Circuit Built-In
- ◆ SOT-23 / SOT-89 / TO-92 / SOT-223 / USP-6B Package
- ◆ Low ESR Capacitors Compatible

GENERAL DESCRIPTION

The XC6202 series are highly precise, low power consumption, high voltage, positive voltage regulators manufactured using CMOS and laser trimming technologies. The XC6202 consists of a current limiter circuit, a driver transistor, a precision reference voltage and an error correction circuit.

Output voltage is selectable in 100mV steps from 1.8V ~ 18V.

The series is also compatible with low ESR ceramic capacitors which give added output stability.

Since the current limiter circuit is built-in, the IC is protected against overshoot currents at such times of output shorts etc.

SOT-23 (150mW), SOT-89 (500mW), TO-92 (300mW), SOT-223 (1200mW) and USP-6B (100mW) packages are available.

TYPICAL APPLICATION CIRCUIT

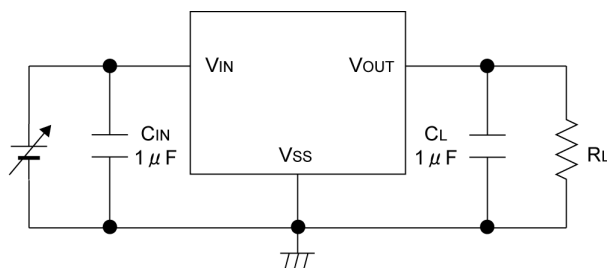

APPLICATIONS

- Battery powered equipment
- Reference voltage
- Cameras, video cameras
- Palmtops

FEATURES

- Maximum Output Current : 150mA
- Dropout Voltage : 200mV @ 30mA
- Operational Voltage Range : Up to 20V
- Output Voltage Range : 1.8V ~ 18V
(Selectable in 100mV steps)
- Highly Accurate : $\pm 2\%$
- Low Power Consumption : 10 μ A (TYP.) ($V_{OUT}=3.3V$)
- Operational Temperature Range : -40°C ~ 85°C
- Line Regulation : 0.01% / V (TYP.)
- Ultra Small Packages : SOT-23 (150mW), SOT-89 (500mW), TO-92 (300mW), SOT-223 (1200mW), USP-6B (100mW)
- Low ESR Capacitor Compatible : Ceramic capacitor

TYPICAL PERFORMANCE CHARACTERISTICS

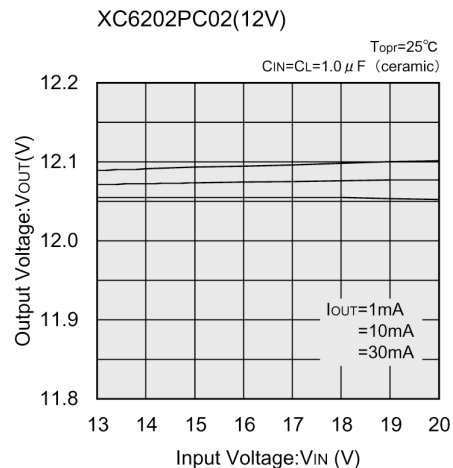

PIN CONFIGURATION

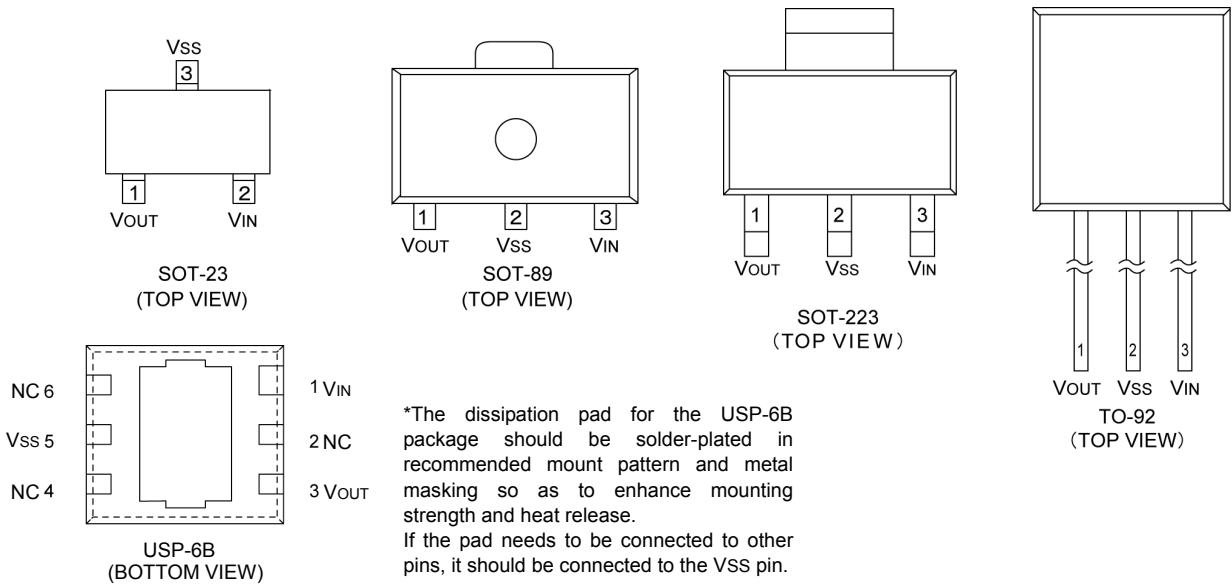

PIN ASSIGNMENT

PIN NUMBER			PIN NAME	FUNCTION
SOT-23	SOT-89/TO-92/ SOT-223	USP-6B		
1	1	3	VOUT	Output
3	2	5	VSS	Ground
2	3	1	VIN	Power Input
—	—	2, 4, 6	NC	No connection

PRODUCT CLASSIFICATION

Ordering Information

XC6202P①②③④⑤

DESIGNATOR	DESCRIPTION	SYMBOL	DESCRIPTION
①②	Output Voltage	18 ~ J0	: For the voltage above 10V, see the example 10=A, 11=B 12=C, 13=D, 14=E, 15=F, 16=G, 17=H, 18=J e.g. VOUT= 3.0V → ①:3, ②:0 VOUT= 12V → ①:C, ②:0 VOUT= 15V → ①:F, ②:0
③	Accuracy	2	: ±2%
④	Package	M	: SOT-23
		P	: SOT-89
		T	: TO-92
		F	: SOT-223
		D	: USP-6B
⑤	Device Orientation	R	: Embossed tape, standard feed
		L	: Embossed tape, reverse feed
		H	: Paper Tape (TO-92)
		B	: Bag (TO-92)

PACKAGING INFORMATION

● SOT-23

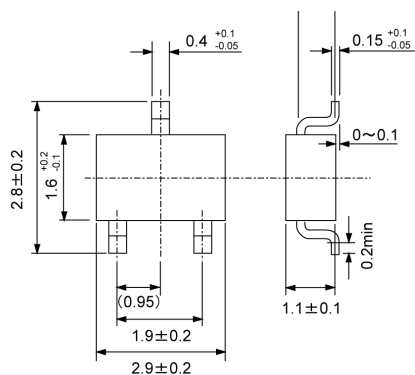

● SOT-89

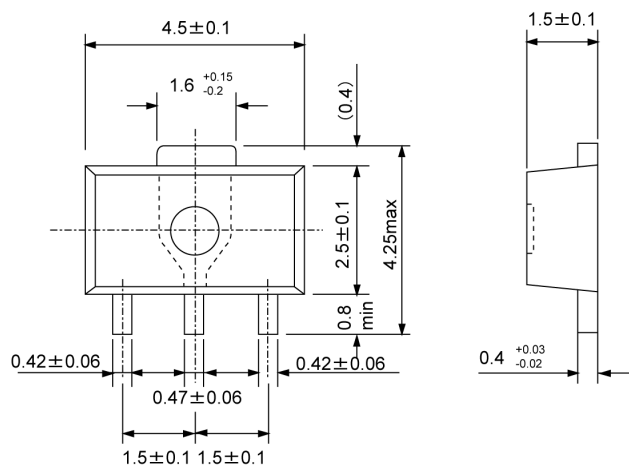

PACKAGING INFORMATION (Continued)

● TO-92

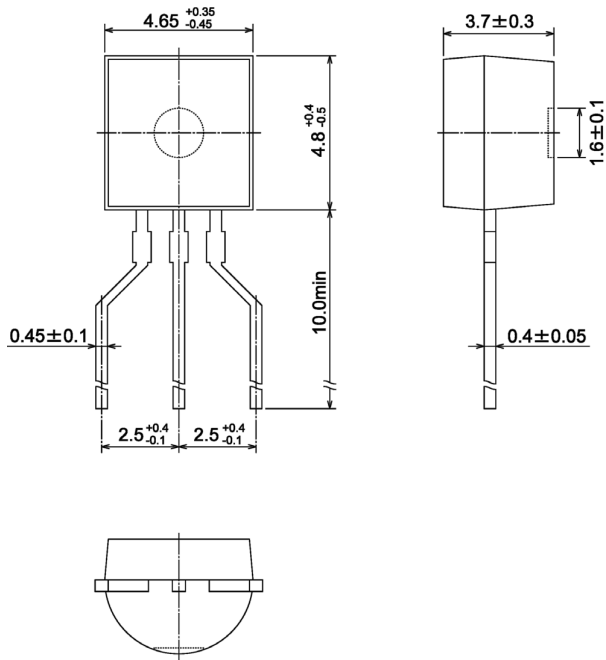

● SOT-223

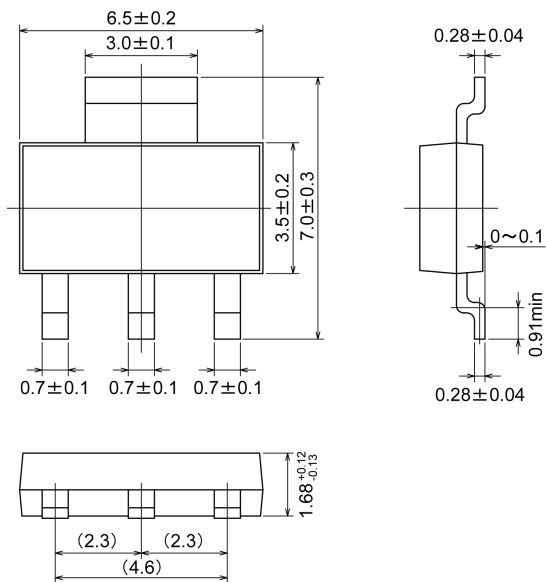

■ PACKAGING INFORMATION (Continued)

● USP-6B

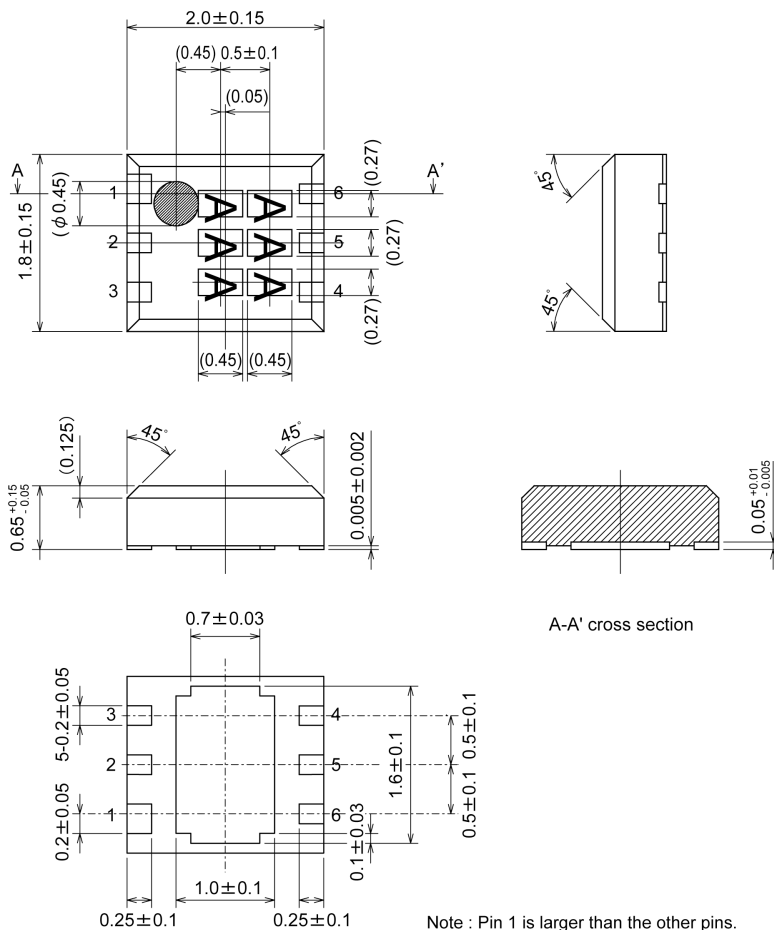

MARKING RULE

● SOT-23, SOT-89, SOT-223

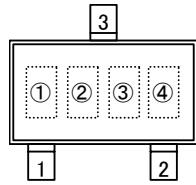

SOT-23
(TOP VIEW)

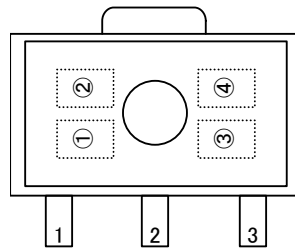

SOT-89
(TOP VIEW)

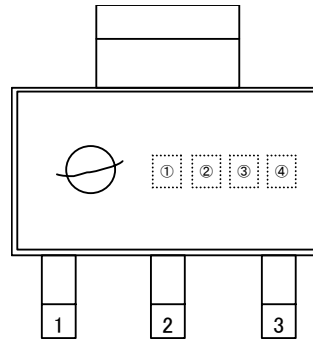

SOT-223
(TOP VIEW)

① Represents product series

MARK	PRODUCT SERIES
2	XC6202Pxxxx

② Represents output voltage range

MARK	VOLTAGE (V)	PRODUCT SERIES
4	0.1 ~ 3.0	XC6202Pxxxx
5	3.1 ~ 6.0	
6	6.1 ~ 9.0	
7	9.1 ~ 12.0	
8	12.1 ~ 15.0	
9	15.1 ~ 18.0	

③ Represents output voltage

MARK	VOLTAGE (V)					MARK	VOLTAGE (V)						
0	—	3.1	6.1	9.1	12.1	15.1	F	—	4.6	7.6	10.6	13.6	16.6
1	—	3.2	6.2	9.2	12.2	15.2	H	—	4.7	7.7	10.7	13.7	16.7
2	—	3.3	6.3	9.3	12.3	15.3	K	1.8	4.8	7.8	10.8	13.8	16.8
3	—	3.4	6.4	9.4	12.4	15.4	L	1.9	4.9	7.9	10.9	13.9	16.9
4	—	3.5	6.5	9.5	12.5	15.5	M	2.0	5.0	8.0	11.0	14.0	17.0
5	—	3.6	6.6	9.6	12.6	15.6	N	2.1	5.1	8.1	11.1	14.1	17.1
6	—	3.7	6.7	9.7	12.7	15.7	P	2.2	5.2	8.2	11.2	14.2	17.2
7	—	3.8	6.8	9.8	12.8	15.8	R	2.3	5.3	8.3	11.3	14.3	17.3
8	—	3.9	6.9	9.9	12.9	15.9	S	2.4	5.4	8.4	11.4	14.4	17.4
9	—	4.0	7.0	10.0	13.0	16.0	T	2.5	5.5	8.5	11.5	14.5	17.5
A	—	4.1	7.1	10.1	13.1	16.1	U	2.6	5.6	8.6	11.6	14.6	17.6
B	—	4.2	7.2	10.2	13.2	16.2	V	2.7	5.7	8.7	11.7	14.7	17.7
C	—	4.3	7.3	10.3	13.3	16.3	X	2.8	5.8	8.8	11.8	14.8	17.8
D	—	4.4	7.4	10.4	13.4	16.4	Y	2.9	5.9	8.9	11.9	14.9	17.9
E	—	4.5	7.5	10.5	13.5	16.5	Z	3.0	6.0	9.0	12.0	15.0	18.0

④ Represents production lot number

0 to 9, A to Z reversed character 0 to 9, A to Z repeated. (G, I, J, O, Q, W excepted)

MARKING RULE(Continued)

●TO-92 (T TYPE)

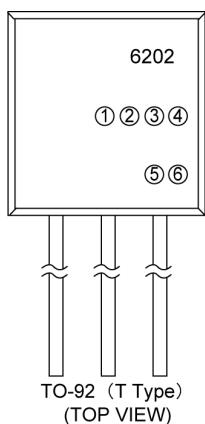

①Represents type of regulator

MARK	PRODUCT SERIES
P	XC6202Pxxxx

②Represents integer of the output voltage

MARK	VOLTAGE (V)	PRODUCT SERIES	MARK	VOLTAGE (V)	PRODUCT SERIES
1	1.x	XC6202P1xxxx	A	10.x	XC6202PAxxxx
2	2.x	XC6202P2xxxx	B	11.x	XC6202PBxxxx
3	3.x	XC6202P3xxxx	C	12.x	XC6202PCxxxx
4	4.x	XC6202P4xxxx	D	13.x	XC6202PDxxxx
5	5.x	XC6202P5xxxx	E	14.x	XC6202PExxxx
6	6.x	XC6202P6xxxx	F	15.x	XC6202PFxxxx
7	7.x	XC6202P7xxxx	G	16.x	XC6202PGxxxx
8	8.x	XC6202P8xxxx	H	17.x	XC6202PHxxxx
9	9.x	XC6202P9xxxx	J	18.x	XC6202PJxxxx

③Represents decimal number of output voltage

MARK	VOLTAGE (V)	PRODUCT SERIES
3	x.3	XC6202Px3xxx
0	x.0	XC6202Px0xxx

④Represents detect voltage accuracy

MARK	DETECT VOLTAGE ACCURACY	PRODUCT SERIES
2	within $\pm 2\%$	XC6202Pxx2xx
1	within $\pm 1\%$	XC6202Pxx1xx

⑤Represents a least significant digit of production year

MARK	PRODUCTION YEAR
3	2003
4	2004

⑥Represents production lot number

0 to 9, A to Z repeated (G, I, J, O, Q, W excepted)

Note: No character inversion used.

MARKING RULE (Continued)

● USP-6B

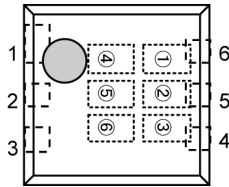

USP-6B
(TOP VIEW)

①② Represents product series

MARK		PRODUCT SERIES
①	②	
0	2	XC6202PxxxDx

③ Represents type of regulator

MARK	PRODUCT SERIES
P	XC6202Pxxxx

④ Represents integer of the output voltage

MARK	VOLTAGE (V)	PRODUCT SERIES	MARK	VOLTAGE (V)	PRODUCT SERIES
1	1.x	XC6202P1xxDx	A	10.x	XC6202PAxxDx
2	2.x	XC6202P2xxDx	B	11.x	XC6202PBxxDx
3	3.x	XC6202P3xxDx	C	12.x	XC6202PCxxDx
4	4.x	XC6202P4xxDx	D	13.x	XC6202PDxxDx
5	5.x	XC6202P5xxDx	E	14.x	XC6202PExxDx
6	6.x	XC6202P6xxDx	F	15.x	XC6202PFxxDx
7	7.x	XC6202P7xxDx	G	16.x	XC6202PGxxDx
8	8.x	XC6202P8xxDx	H	17.x	XC6202PHxxDx
9	9.x	XC6202P9xxDx	J	18.x	XC6202PJxxDx

⑤ Represents decimal number of output voltage

MARK	VOLTAGE (V)	PRODUCT SERIES
3	X.3	XC6202Px3xDx
0	X.0	XC6202Px0xDx

⑥ Represents production lot number

0 to 9, A to Z repeated (G, I, J, O, Q, W excepted)

Note: No character inversion used.

■ BLOCK DIAGRAM

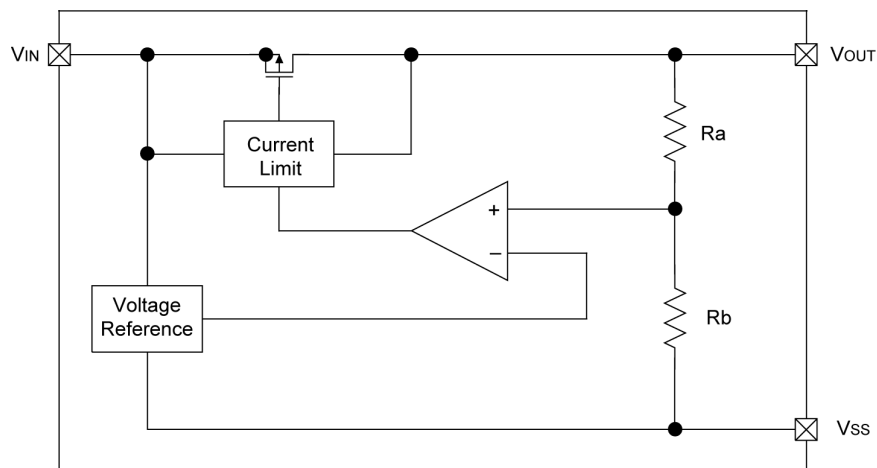

■ ABSOLUTE MAXIMUM RATINGS

Ta = 25°C

PARAMETER	SYMBOL	RATINGS	UNITS
Input Voltage	V _{IN}	22.0	V
Output Current	I _{OUT}	500	mA
Output Voltage	V _{OUT}	V _{SS} -0.3 ~ V _{IN} +0.3	V
Power Dissipation	SOT-25	150	mW
	SOT-89	500	
	TO-92	300	
	USP-6B	100	
	SOT-223	1,200*	
Operating Temperature Range	T _{opr}	-40 ~ +85	°C
Storage Temperature Range	T _{stg}	-55 ~ +125	°C

* Circuits board mounting: Double-sided board

ELECTRICAL CHARACTERISTICS

XC6202P182

$V_{OUT(T)}=1.8V^{(*)1}$

$T_{opr}=25^{\circ}C$

PARAMETER	SYMBOL	CONDITIONS	MIN	TYP	MAX	UNITS	CIRCUIT
Output Voltage	$V_{OUT(E)}^{(*)2}$	$V_{IN}=2.8V$ $I_{OUT}=30mA$	1.764	1.800	1.836	V	②
Maximum Output Current	I_{OUTmax}	$V_{IN}=2.8V$ $V_{OUT} \geq V_{OUT(E)} \times 0.9$	60	-	-	mA	②
Load Regulation	ΔV_{OUT}	$V_{IN}=2.3V$ $1mA \leq I_{OUT} \leq 100mA$	-	10	80	mV	②
Dropout Voltage ^{(*)3}	Vdif1	$I_{OUT}=30mA$	-	340	470	mV	②
	Vdif2	$I_{OUT}=100mA$	-	1000	1500		
Supply Current	I_{SS}	$V_{IN}=2.8V$	-	10	24	μA	①
Line Regulation	$\frac{\Delta V_{OUT}}{\Delta V_{IN} \cdot \Delta V_{OUT}}$	$I_{OUT}=1mA$ $2.8V \leq V_{IN} \leq 20V$	-	0.01	0.20	%/V	②
Input Voltage	V_{IN}		-	-	20	V	-
Output Voltage Temperature Characteristics	$\frac{\Delta V_{OUT}}{\Delta T_{opr} \cdot \Delta V_{OUT}}$	$I_{OUT}=30mA$ $-40^{\circ}C \leq T_{opr} \leq 85^{\circ}C$	-	± 100	-	ppm/ $^{\circ}C$	②
Short-circuit Current	I_{short}	$V_{IN}=3.8V$	-	40	-	mA	②

XC6202P332

$V_{OUT(T)}=3.3V^{(*)1}$

$T_{opr}=25^{\circ}C$

PARAMETER	SYMBOL	CONDITIONS	MIN	TYP	MAX	UNITS	CIRCUIT
Output Voltage	$V_{OUT(E)}^{(*)2}$	$V_{IN}=4.3V$ $I_{OUT}=30mA$	3.234	3.300	3.366	V	②
Maximum Output Current	I_{OUTmax}	$V_{IN}=4.3V$ $V_{OUT} \geq V_{OUT(E)} \times 0.9$	150	-	-	mA	②
Load Regulation	ΔV_{OUT}	$V_{IN}=4.3V$ $1mA \leq I_{OUT} \leq 100mA$	-	25	90	mV	②
Dropout Voltage ^{(*)3}	Vdif1	$I_{OUT}=30mA$	-	200	280	mV	②
	Vdif2	$I_{OUT}=100mA$	-	670	900		
Supply Current	I_{SS}	$V_{IN}=4.3V$	-	10	24	μA	①
Line Regulation	$\frac{\Delta V_{OUT}}{\Delta V_{IN} \cdot \Delta V_{OUT}}$	$I_{OUT}=1mA$ $4.3V \leq V_{IN} \leq 20V$	-	0.01	0.20	%/V	②
Input Voltage	V_{IN}		-	-	20	V	-
Output Voltage Temperature Characteristics	$\frac{\Delta V_{OUT}}{\Delta T_{opr} \cdot \Delta V_{OUT}}$	$I_{OUT}=30mA$ $-40^{\circ}C \leq T_{opr} \leq 85^{\circ}C$	-	± 100	-	ppm/ $^{\circ}C$	②
Short-circuit Current	I_{short}	$V_{IN}=5.3V$	-	40	-	mA	②

■ ELECTRICAL CHARACTERISTICS (Continued)

XC6202P502

 $V_{OUT(T)}=5.0V^{(*)}$
 $T_{opr}=25^{\circ}C$

PARAMETER	SYMBOL	CONDITIONS	MIN	TYP	MAX	UNITS	CIRCUIT
Output Voltage	$V_{OUT(E)}^{(*)}$	$V_{IN}=6V$ $I_{OUT}=30mA$	4.900	5.000	5100	V	②
Maximum Output Current	I_{OUTmax}	$V_{IN}=6V$ $V_{OUT} \geq V_{OUT(E)} \times 0.9$	200	-	-	mA	②
Load Regulation	ΔV_{OUT}	$V_{IN}=6V$ $1mA \leq I_{OUT} \leq 100mA$	-	30	100	mV	②
Dropout Voltage ^(*)	Vdif1	$I_{OUT}=30mA$	-	130	190	mV	②
	Vdif2	$I_{OUT}=100mA$	-	440	550		
Supply Current	I_{SS}	$V_{IN}=6V$	-	10	24	μA	①
Line Regulation	$\frac{\Delta V_{OUT}}{\Delta V_{IN} \cdot \Delta V_{OUT}}$	$I_{OUT}=1mA$ $6V \leq V_{IN} \leq 20V$	-	0.01	0.20	%/V	②
Input Voltage	V_{IN}		-	-	20	V	-
Output Voltage Temperature Characteristics	$\frac{\Delta V_{OUT}}{\Delta T_{opr} \cdot \Delta V_{OUT}}$	$I_{OUT}=30mA$ $-40^{\circ}C \leq T_{opr} \leq 85^{\circ}C$	-	± 100	-	ppm/ $^{\circ}C$	②
Short-circuit Current	I_{short}	$V_{IN}=7V$	-	40	-	mA	②

XC6202PC02

 $V_{OUT(T)}=3.3V^{(*)}$
 $T_{opr}=25^{\circ}C$

PARAMETER	SYMBOL	CONDITIONS	MIN	TYP	MAX	UNITS	CIRCUIT
Output Voltage	$V_{OUT(E)}^{(*)}$	$V_{IN}=13V$ $I_{OUT}=30mA$	11.760	12.000	12.240	V	②
Maximum Output Current	I_{OUTmax}	$V_{IN}=13V$ $V_{OUT} \geq V_{OUT(E)} \times 0.9$	200	-	-	mA	②
Load Regulation	ΔV_{OUT}	$V_{IN}=13V$ $1mA \leq I_{OUT} \leq 100mA$	-	60	230	mV	②
Dropout Voltage ^(*)	Vdif1	$I_{OUT}=30mA$	-	90	150	mV	②
	Vdif2	$I_{OUT}=100mA$	-	290	380		
Supply Current	I_{SS}	$V_{IN}=13V$	-	12	28	μA	①
Line Regulation	$\frac{\Delta V_{OUT}}{\Delta V_{IN} \cdot \Delta V_{OUT}}$	$I_{OUT}=1mA$ $13V \leq V_{IN} \leq 20V$	-	0.01	0.20	%/V	②
Input Voltage	V_{IN}		-	-	20	V	-
Output Voltage Temperature Characteristics	$\frac{\Delta V_{OUT}}{\Delta T_{opr} \cdot \Delta V_{OUT}}$	$I_{OUT}=30mA$ $-40^{\circ}C \leq T_{opr} \leq 85^{\circ}C$	-	± 100	-	ppm/ $^{\circ}C$	②
Short-circuit Current	I_{short}	$V_{IN}=7V$	-	40	-	mA	②

■ ELECTRICAL CHARACTERISTICS (Continued)

XC6202PJ02

$V_{OUT(T)}=18V^{(*)}$

Topr=25°C

PARAMETER	SYMBOL	CONDITIONS	MIN.	TYP.	MAX.	UNITS	CIRCUIT
Output Voltage	$V_{OUT(E)}^{(*)2}$	$V_{IN}=19V$ $I_{OUT}=30mA$	17.640	18.000	18.360	V	②
Maximum Output Current	I_{OUTmax}	$V_{IN}=19V$ $V_{OUT} \geq V_{OUT(E)} \times 0.9$	200	-	-	mA	②
Load Regulation	ΔV_{OUT}	$V_{IN}=19V$ $1mA \leq I_{OUT} \leq 100mA$	-	120	380	mV	②
Dropout Voltage ^{(*)3}	Vdif1	$I_{OUT}=30mA$	-	80	150	mV	②
	Vdif2	$I_{OUT}=100mA$	-	280	380		
Supply Current	I_{SS}	$V_{IN}=19V$	-	15	30	μA	①
Line Regulation	$\frac{\Delta V_{OUT}}{\Delta V_{IN} \cdot \Delta V_{OUT}}$	$I_{OUT}=1mA$ $19V \leq V_{IN} \leq 20V$	-	0.01	0.20	%/V	②
Input Voltage	V_{IN}		-	-	20	V	-
Output Voltage Temperature Characteristics	$\frac{\Delta V_{OUT}}{\Delta T_{opr} \cdot \Delta V_{OUT}}$	$I_{OUT}=30mA$ $-40^{\circ}C \leq T_{opr} \leq 85^{\circ}C$	-	± 100	-	ppm/ °C	②
Short-circuit Current	I_{short}	$V_{IN}=20V$	-	40	-	mA	②

*1. $V_{OUT(T)}$ = Specified output voltage.

*2. $V_{OUT(E)}$ = Effective output voltage (i.e. the output voltage when " $V_{OUT(T)}+1.0V$ " is provided at the V_{IN} pin while maintaining certain I_{OUT} value).

*3. $V_{dif} = V_{IN1} - V_{OUT1}$

*4. V_{OUT1} = A voltage equal to 98% of the output voltage when " $V_{OUT(T)} + 1.0V$ " is input.

*5. V_{IN1} = The input voltage when V_{OUT1} is output following a gradual decrease in the input voltage.

■ TEST CIRCUITS

CIRCUIT ①

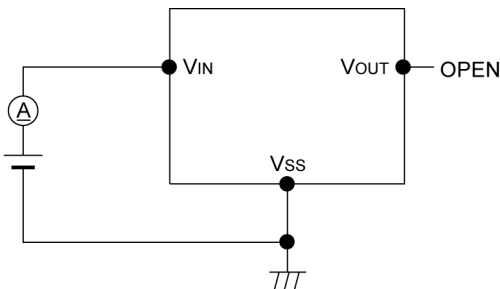

CIRCUIT ②

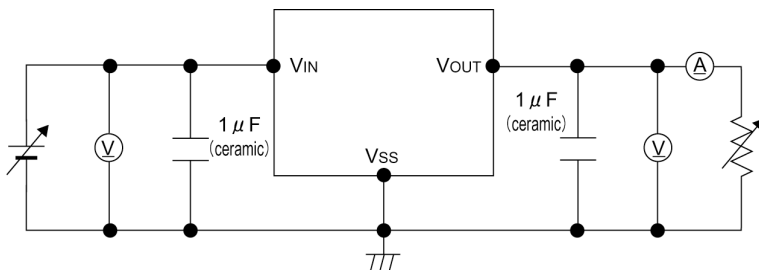

TYPICAL PERFORMANCE CHARACTERISTICS

●XC6202P182

(1) Output Voltage vs. Output Current

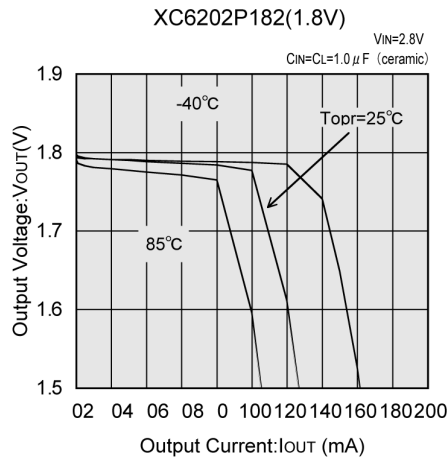

(2) Output Voltage vs. Input Voltage

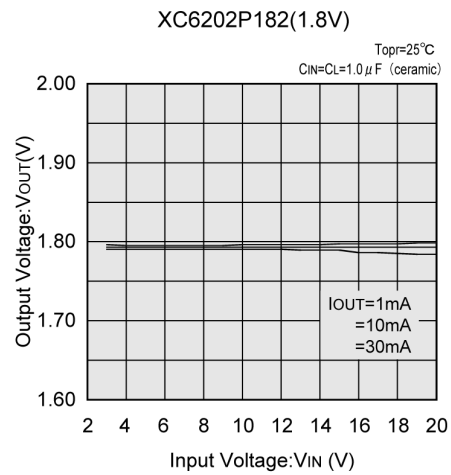
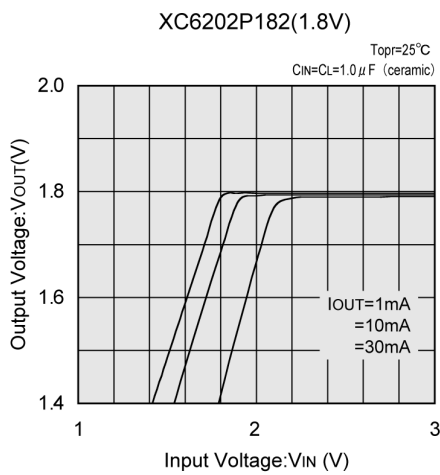

(3) Dropout Voltage vs. Output Current

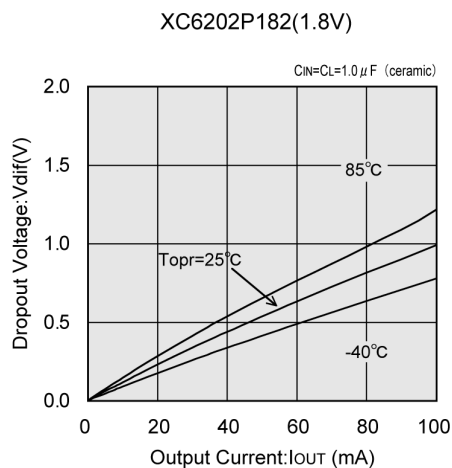

■ TYPICAL PERFORMANCE CHARACTERISTICS (Continued)

● XC6202P182 (Continued)

(4) Supply Current vs. Input Voltage

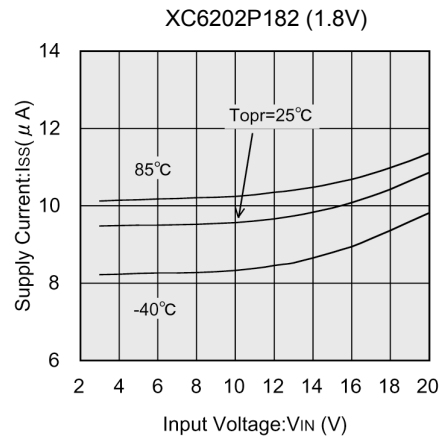
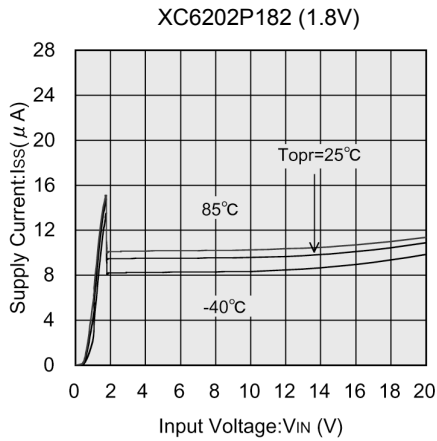

(5) Output Voltage vs. Ambient Temperature

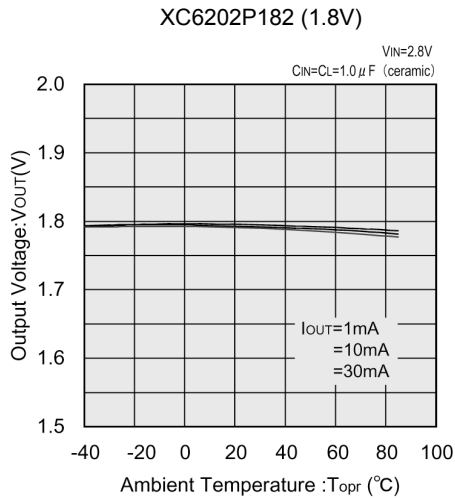

(6) Supply Current vs. Ambient Temperature

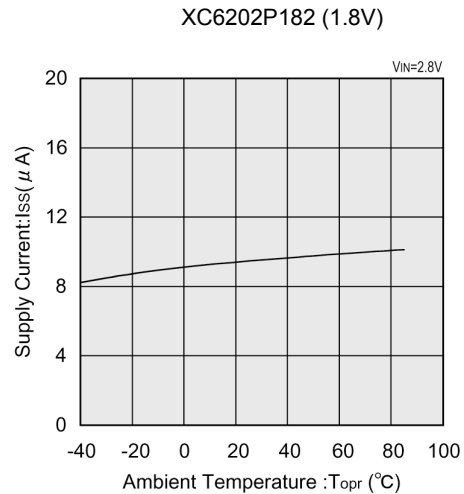

(7) Current Limiter Circuit

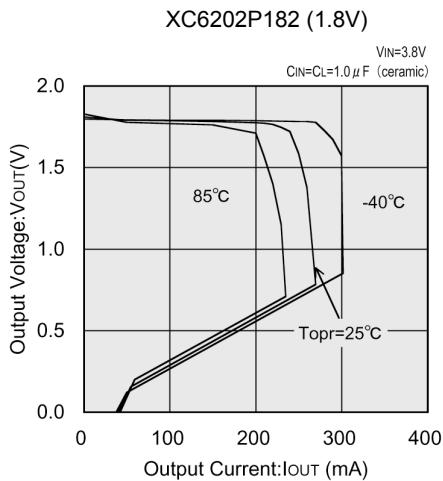

■ TYPICAL PERFORMANCE CHARACTERISTICS (Continued)

● XC6202P182 (Continued)

(8) Input Transient Response 1

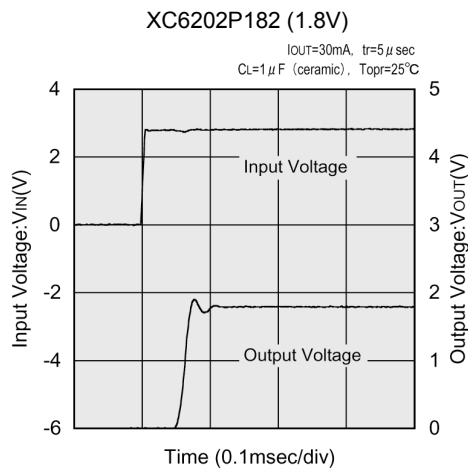
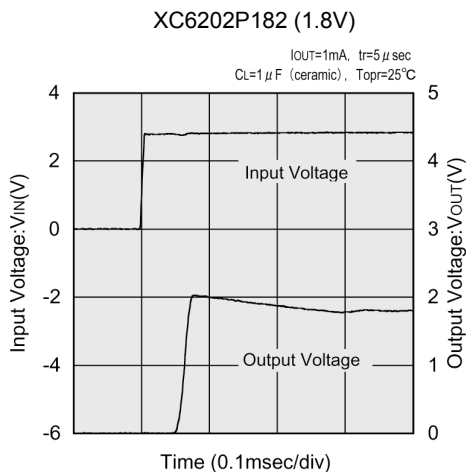

(9) Input Transient Response 2

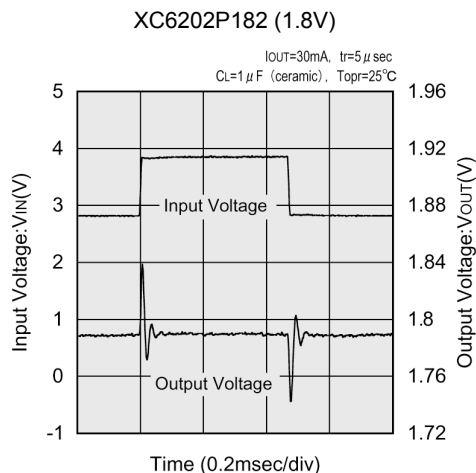
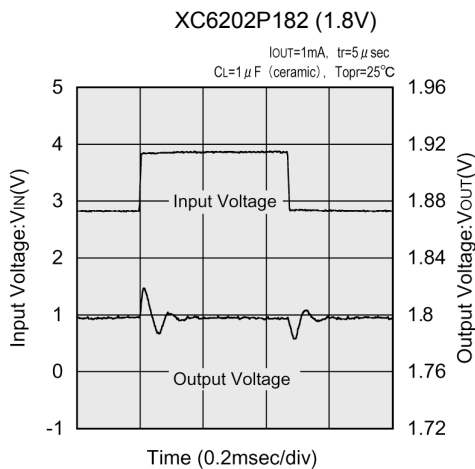

(10) Load Transient Response

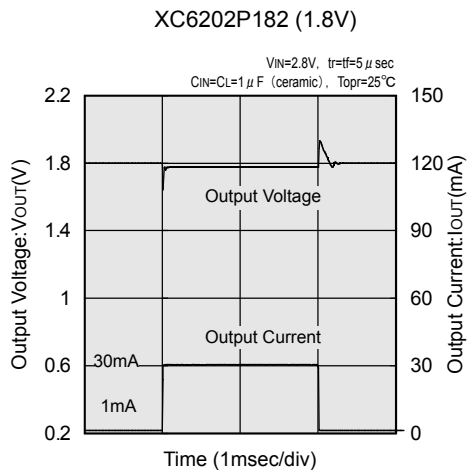

■ TYPICAL PERFORMANCE CHARACTERISTICS (Continued)

● XC6202P182 (Continued)

(11) Ripple Rejection Rate

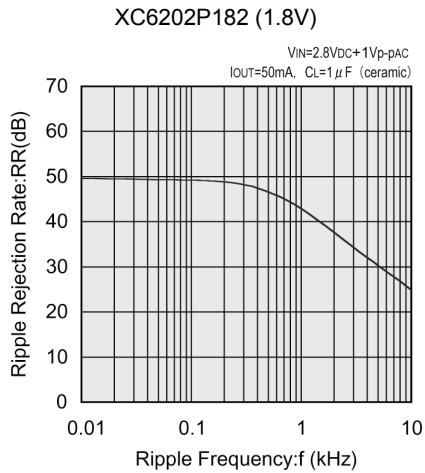
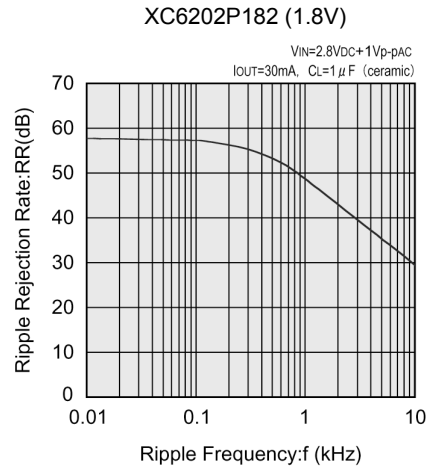
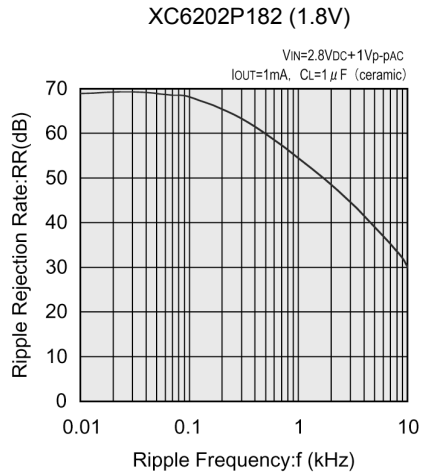

■ TYPICAL PERFORMANCE CHARACTERISTICS (Continued)

● XC6202P332

(1) Output Voltage vs. Output Current

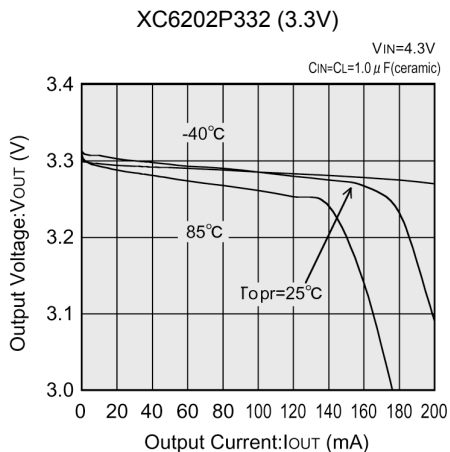

(2) Output Voltage vs. Input Voltage

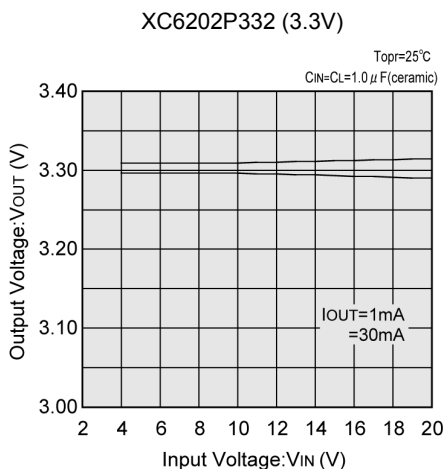
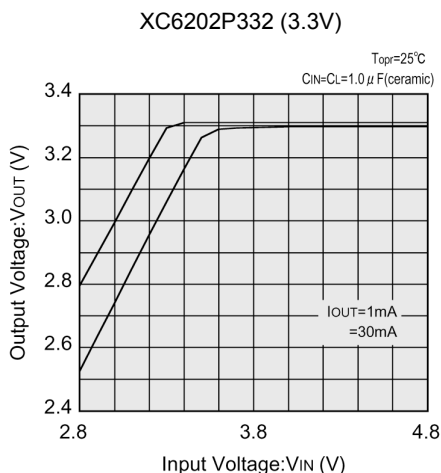

(3) Dropout Voltage vs. Output Current

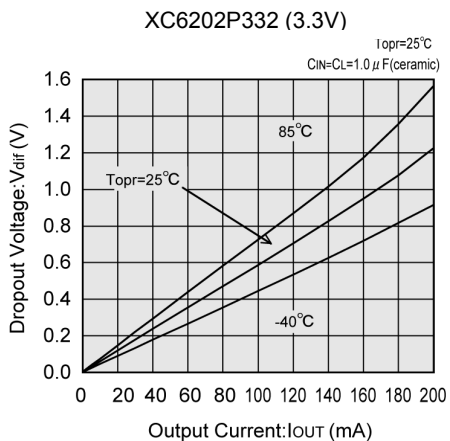

■ TYPICAL PERFORMANCE CHARACTERISTICS (Continued)

● XC6202P332 (Continued)

(4) Supply Current vs. Input Voltage

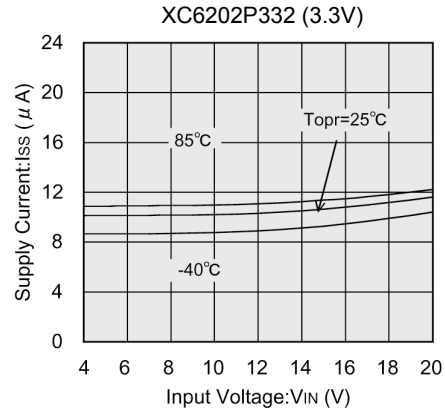
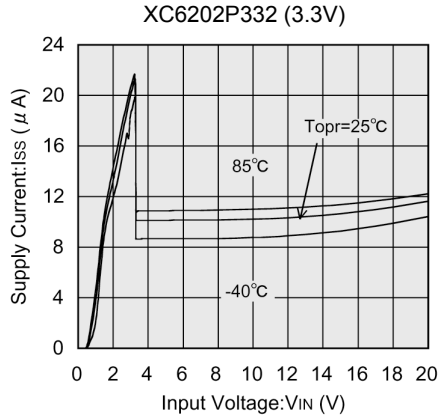

(5) Output Voltage vs. Ambient Temperature

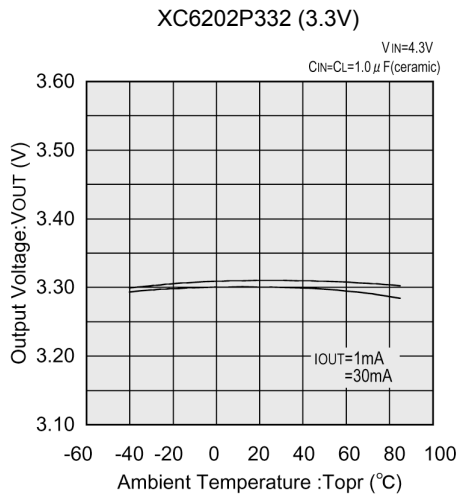

(6) Supply Current vs. Ambient Temperature

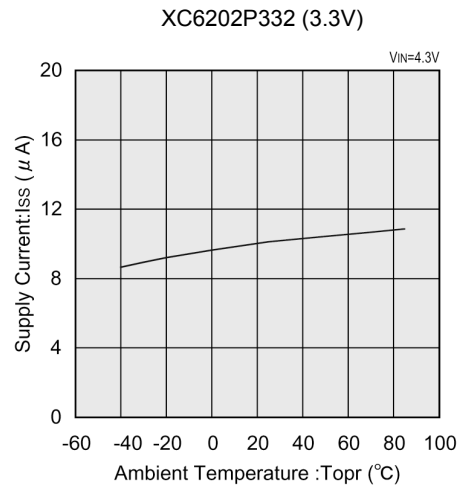

(7) Current Limiter Circuit

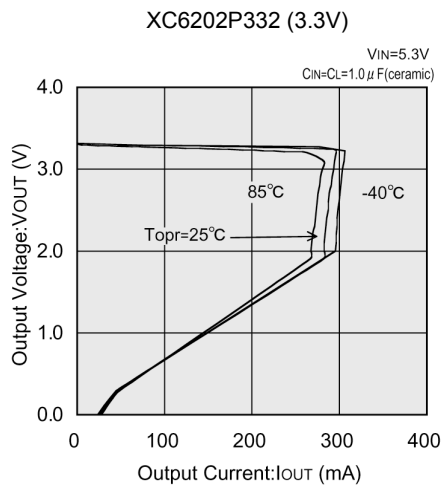

■ TYPICAL PERFORMANCE CHARACTERISTICS (Continued)

● XC6202P332 (Continued)

(8) Input Transient Response 1

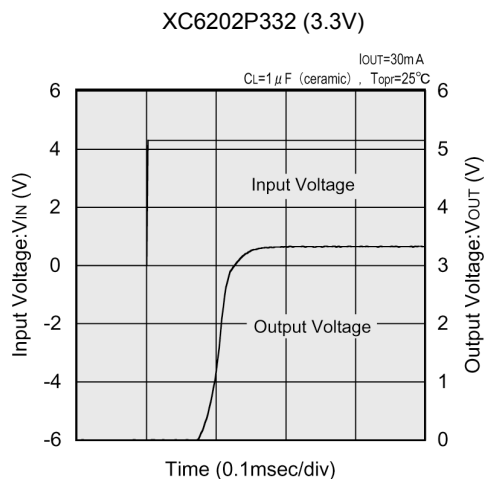

(9) Input Transient Response 2

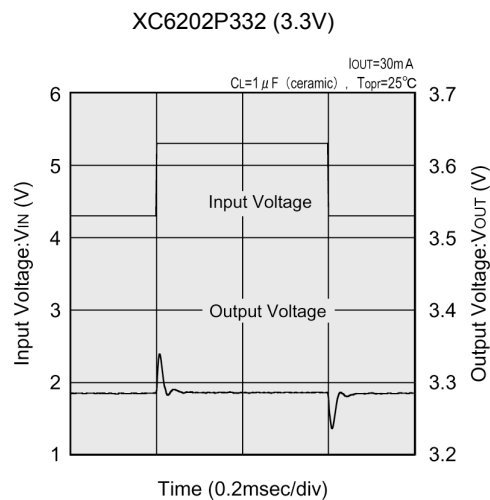
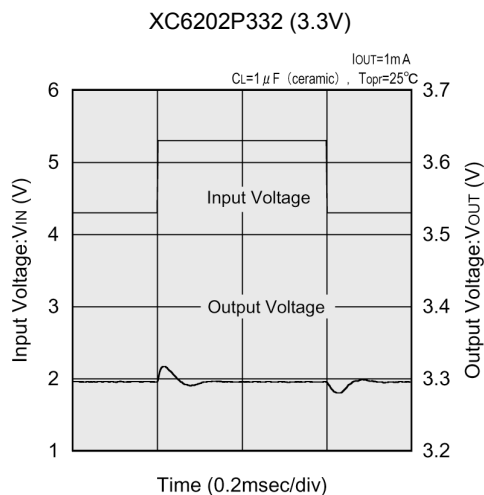

(10) Load Transient Response

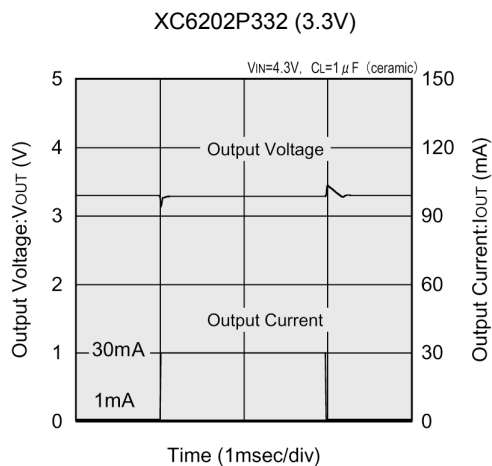

TYPICAL PERFORMANCE CHARACTERISTICS (Continued)

●XC6202P332 (Continued)

(11) Ripple Rejection Rate

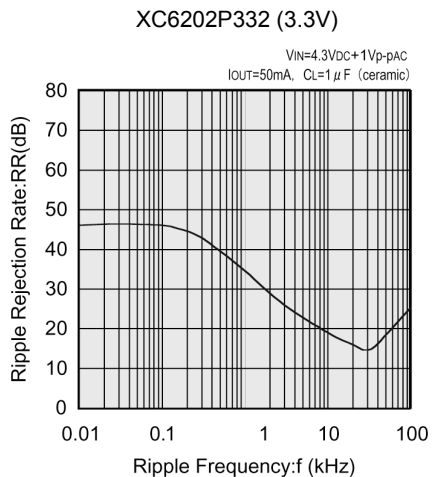
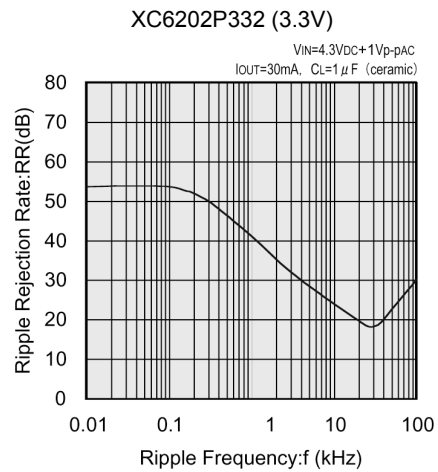
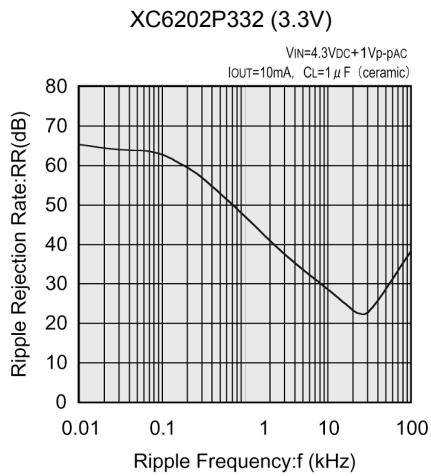
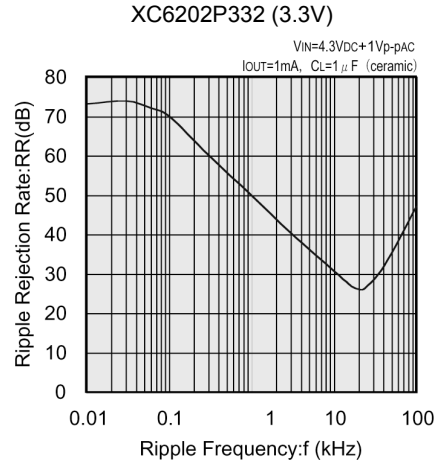
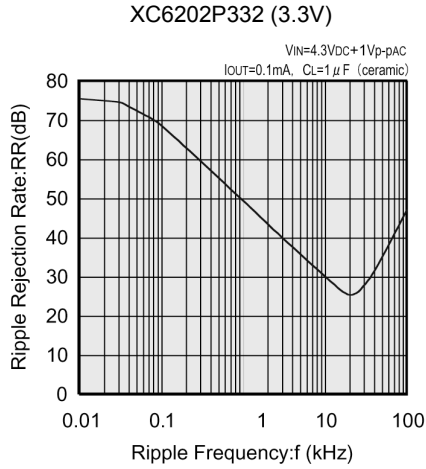

■ TYPICAL PERFORMANCE CHARACTERISTICS (Continued)

● XC6202P502

(1) Output Voltage vs. Output Current

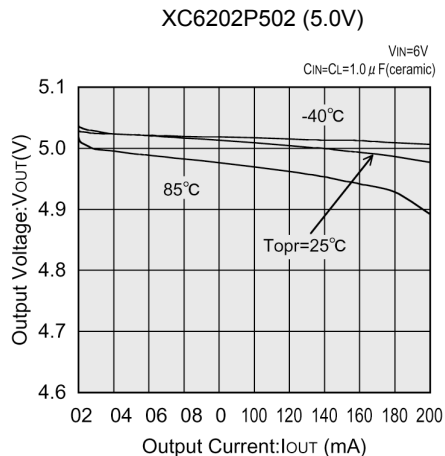

(2) Output Voltage vs. Input Voltage

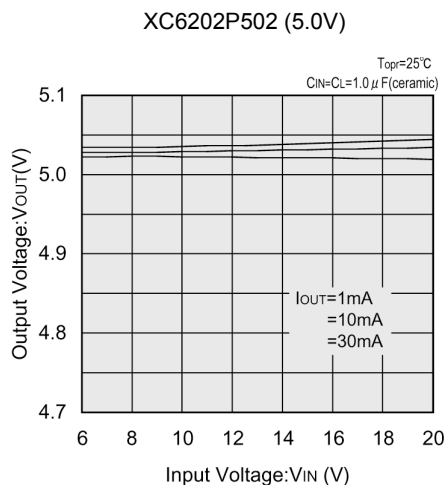
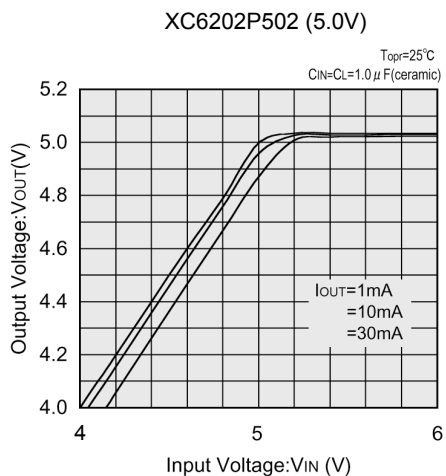

(3) Dropout Voltage vs. Output Current

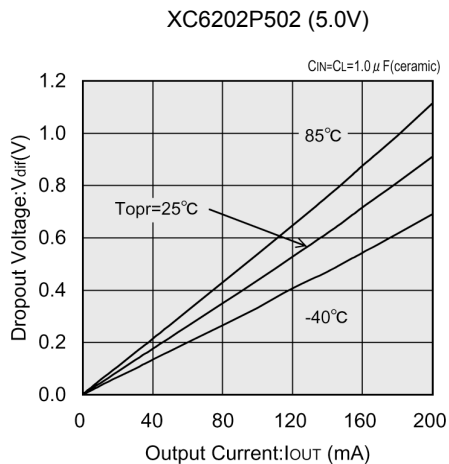

TYPICAL PERFORMANCE CHARACTERISTICS (Continued)

●XC6202P502 (Continued)

(4) Supply Current vs. Input Voltage

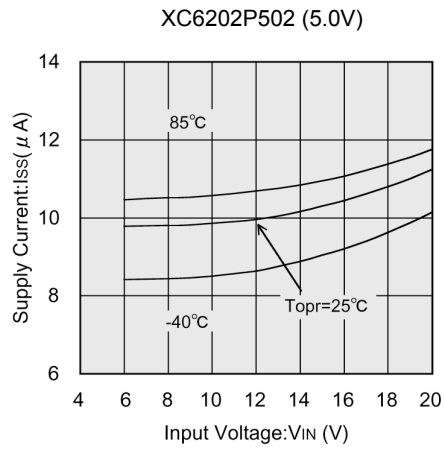
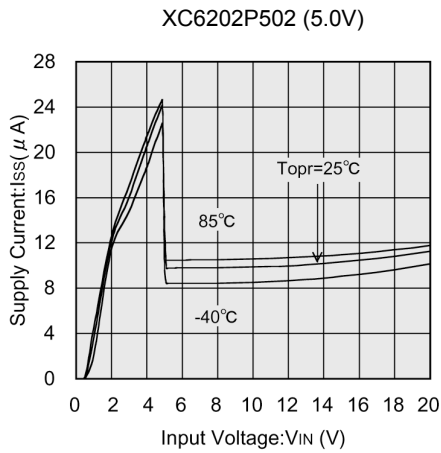

(5) Output Voltage vs. Ambient Temperature

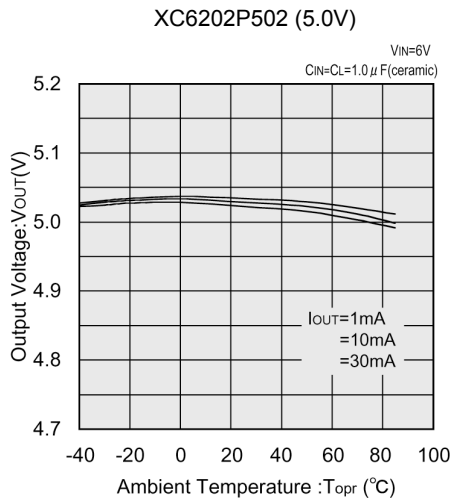

(6) Supply Current vs. Ambient Temperature

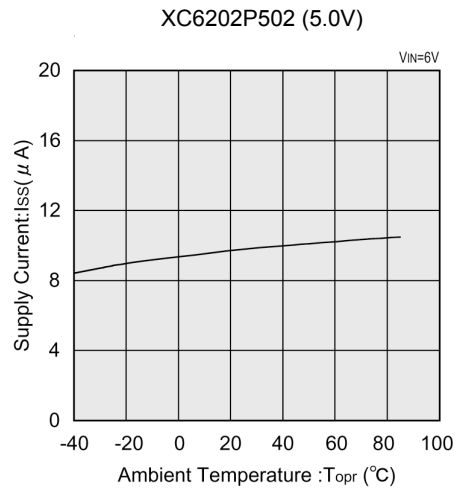

(7) Current Limiter Circuit

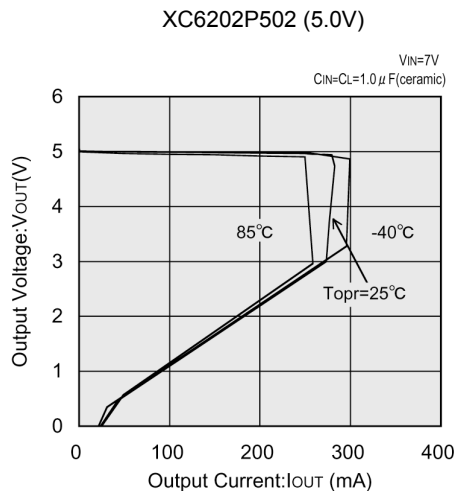

■ TYPICAL PERFORMANCE CHARACTERISTICS (Continued)

● XC6202P502 (Continued)

(8) Input Transient Response 1

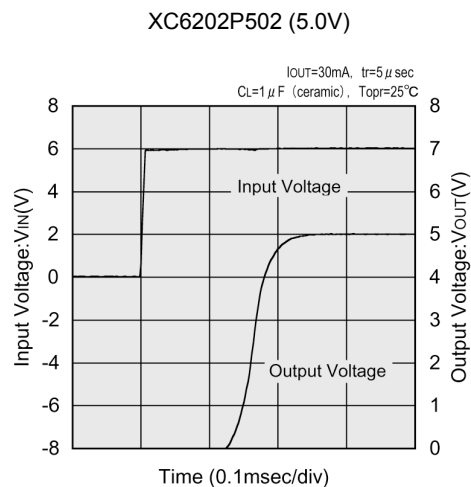
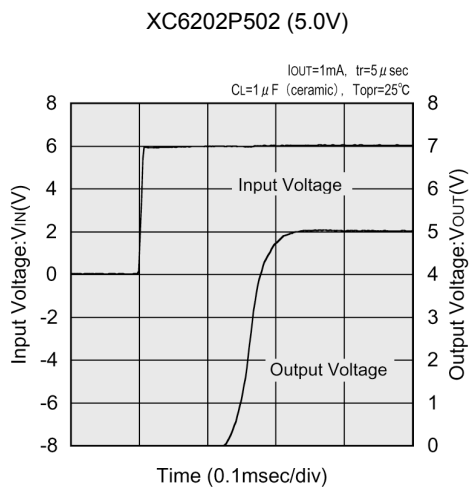

(9) Input Transient Response 2

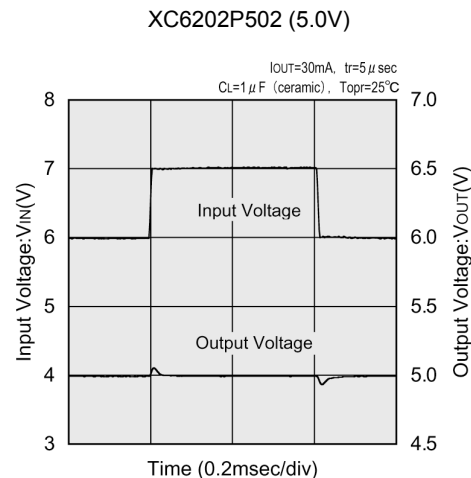
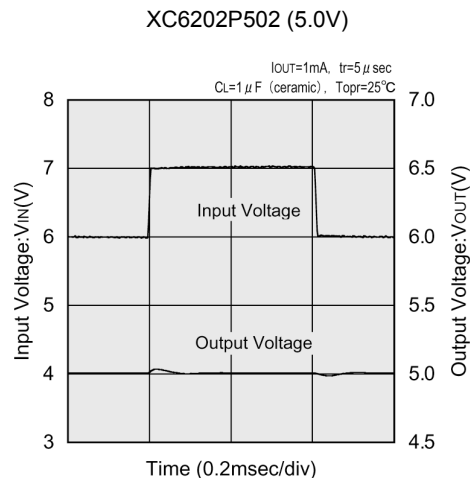

(10) Load Transient Response

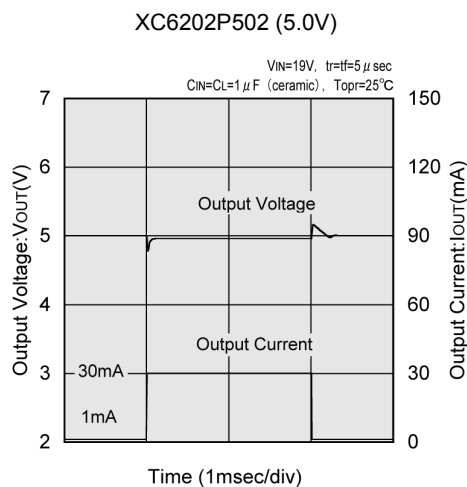

TYPICAL PERFORMANCE CHARACTERISTICS (Continued)

●XC6202P502 (Continued)

(11) Ripple Rejection Rate

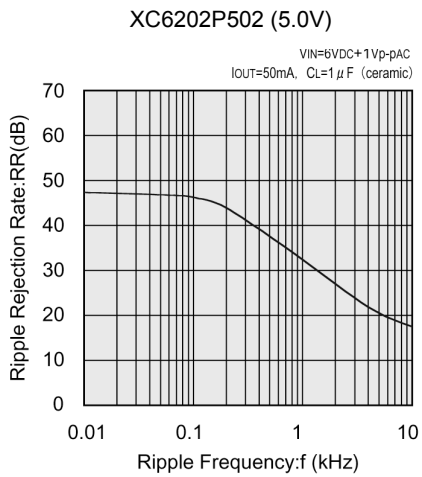
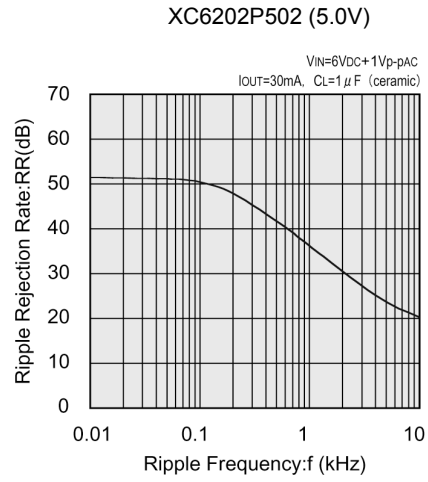
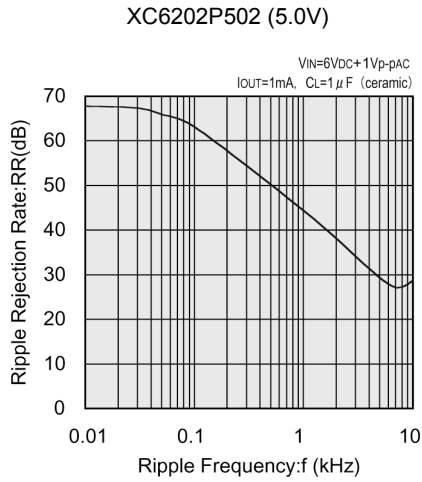

■ TYPICAL PERFORMANCE CHARACTERISTICS (Continued)

● XC6202PC02

(1) Output Voltage vs. Output Current

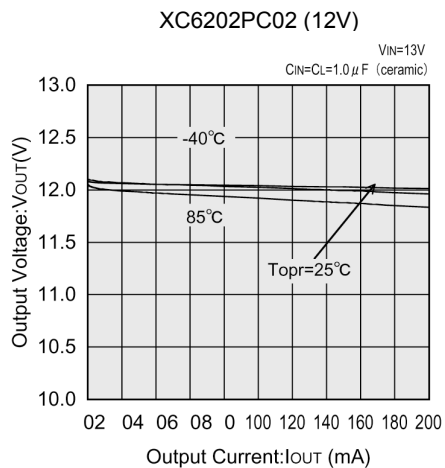

(2) Output Voltage vs. Input Voltage

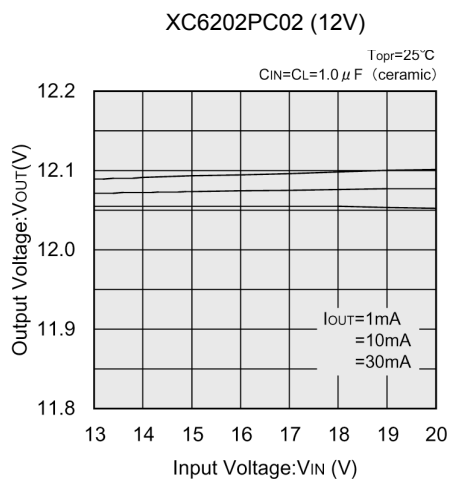
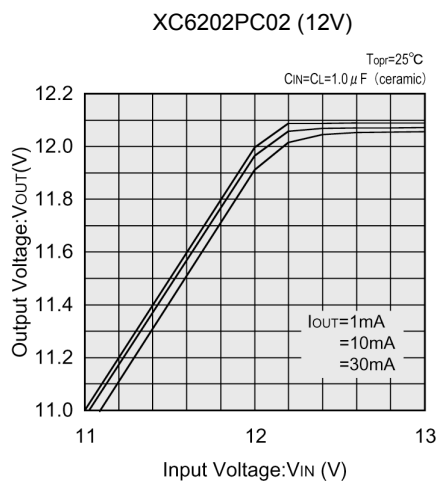

(3) Dropout Voltage vs. Output Current

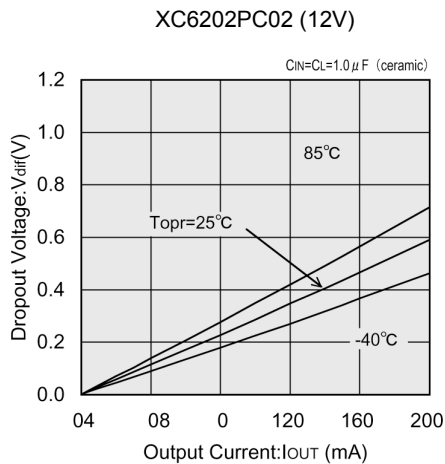

TYPICAL PERFORMANCE CHARACTERISTICS (Continued)

●XC6202PC02 (Continued)

(4) Supply Current vs. Input Voltage

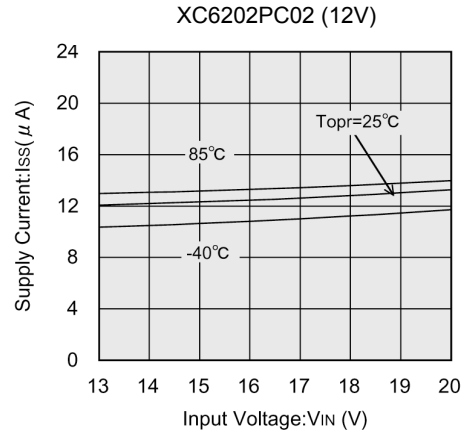
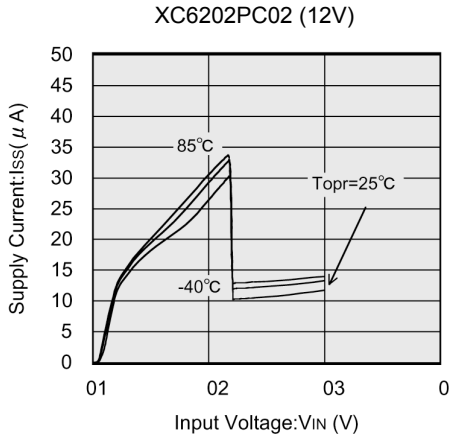

(5) Output Voltage vs. Ambient Temperature

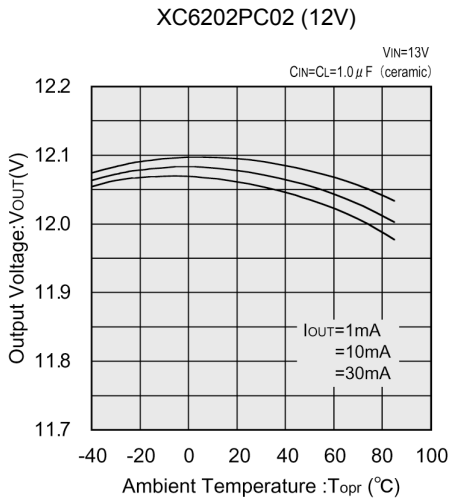

(6) Supply Current vs. Ambient Temperature

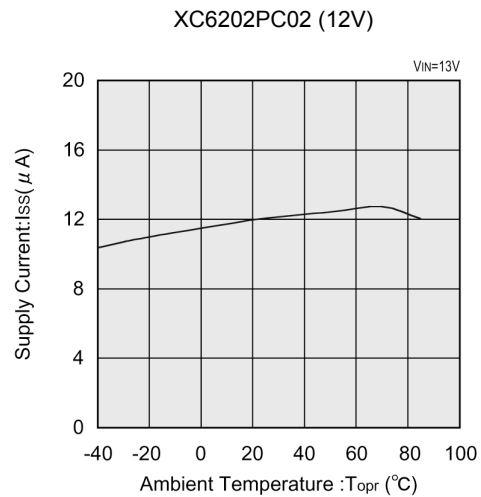

(7) Current Limiter Circuit

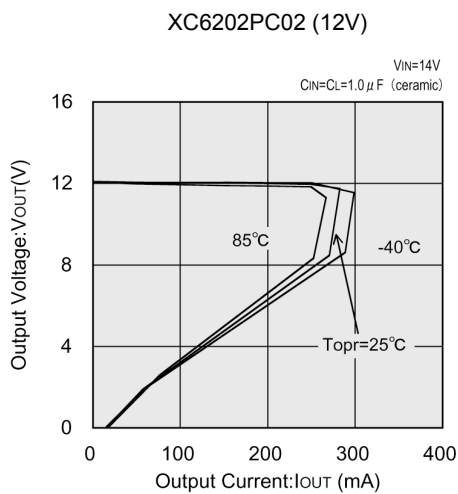

■ TYPICAL PERFORMANCE CHARACTERISTICS (Continued)

● XC6202PC02 (Continued)

(8) Input Transient Response 1

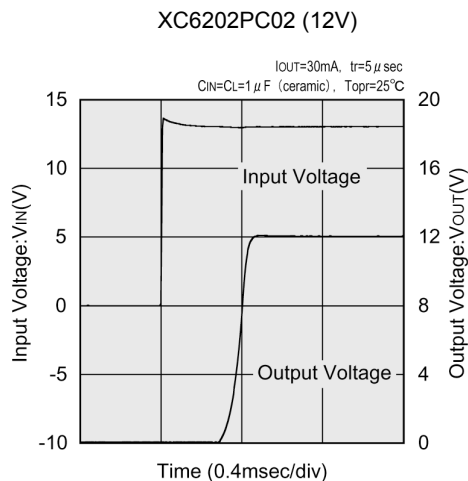
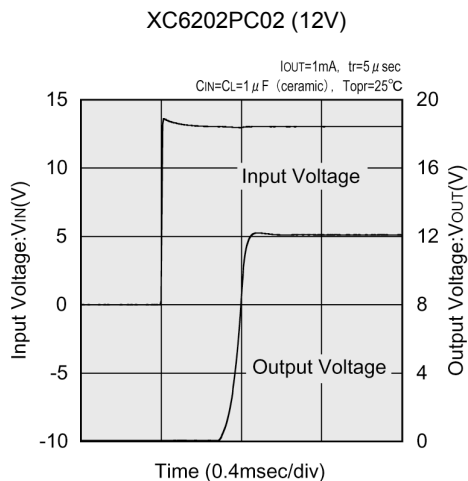

(9) Input Transient Response 2

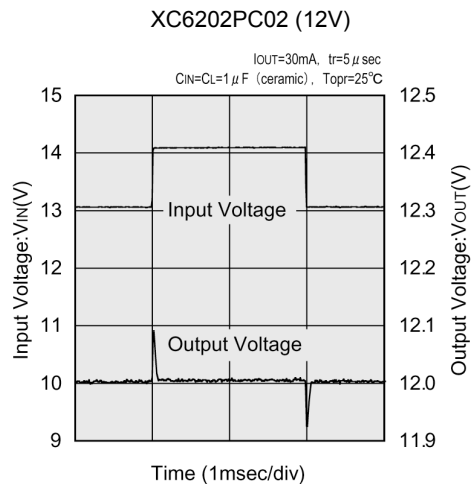
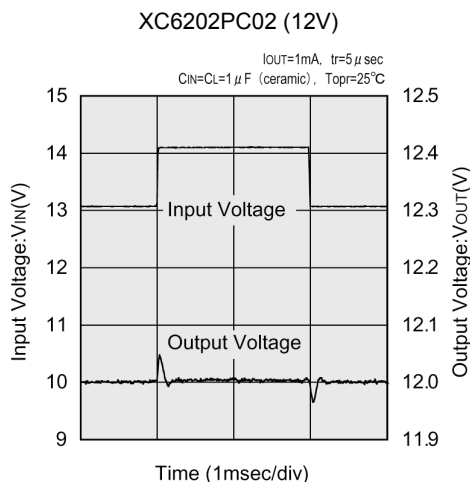

(10) Load Transient Response

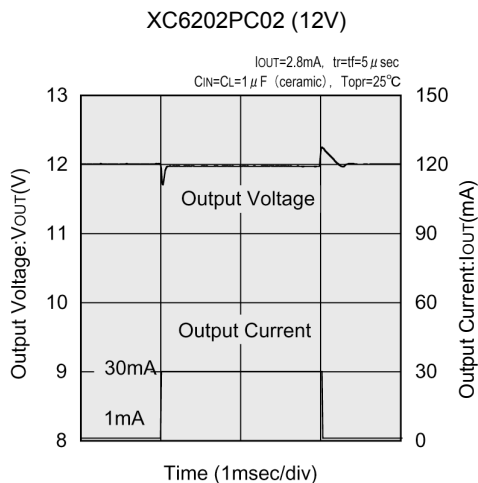

■ TYPICAL PERFORMANCE CHARACTERISTICS (Continued)

● XC6202PC02 (Continued)

(11) Ripple Rejection Rate

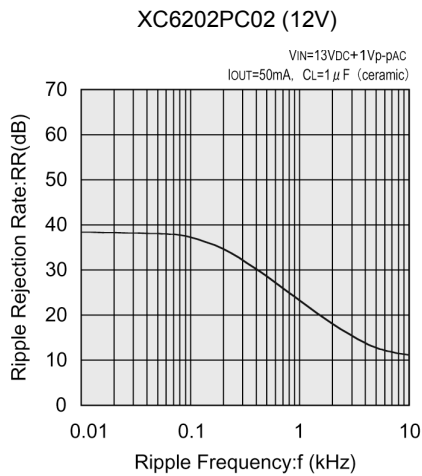
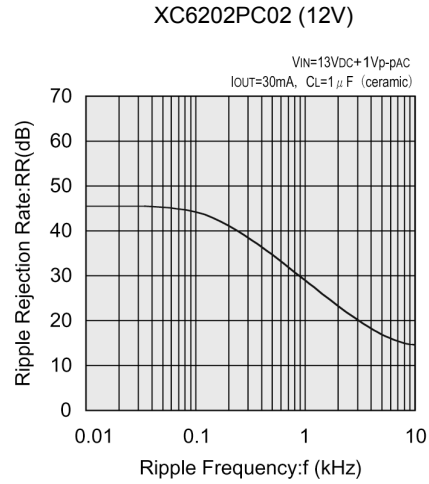
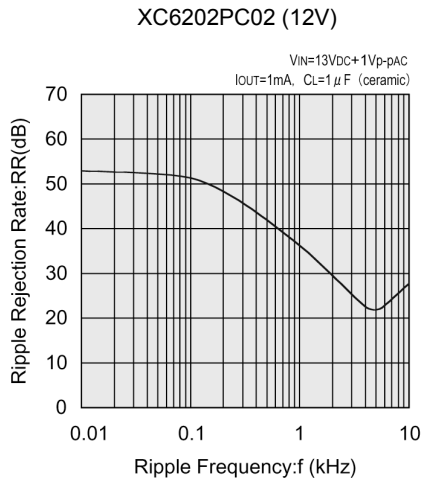

■ TYPICAL PERFORMANCE CHARACTERISTICS (Continued)

● XC6202PJ02

(1) Output Voltage vs. Output Current

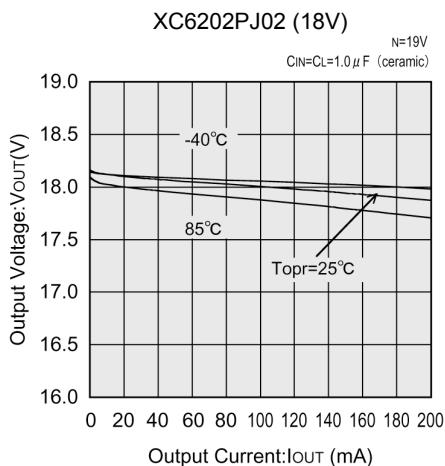

(2) Output Voltage vs. Input Voltage

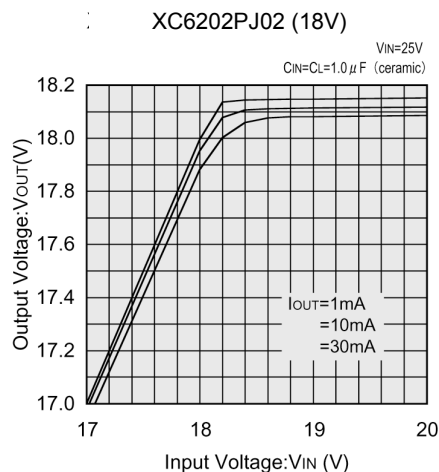

(3) Dropout Voltage vs. Output Current

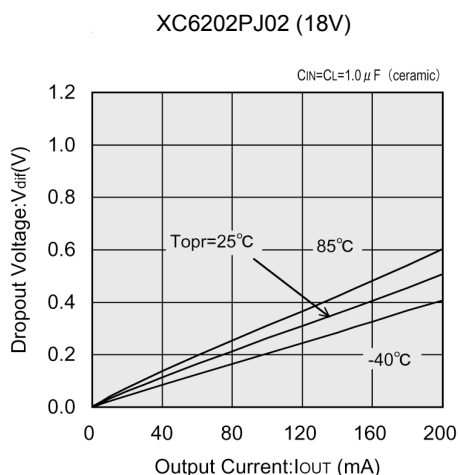

(4) Supply Current vs. Input Voltage

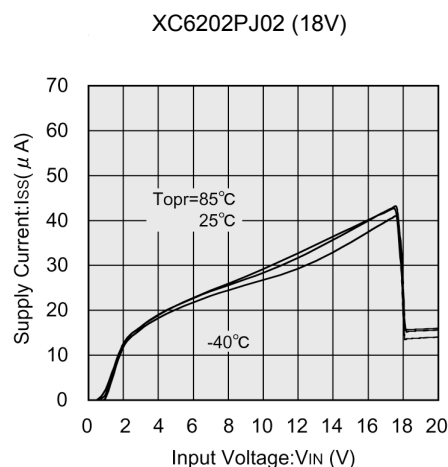

(5) Output Voltage vs. Ambient Temperature

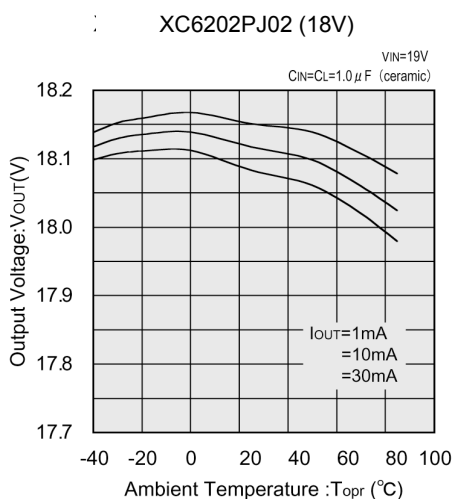

(6) Supply Current vs. Ambient Temperature

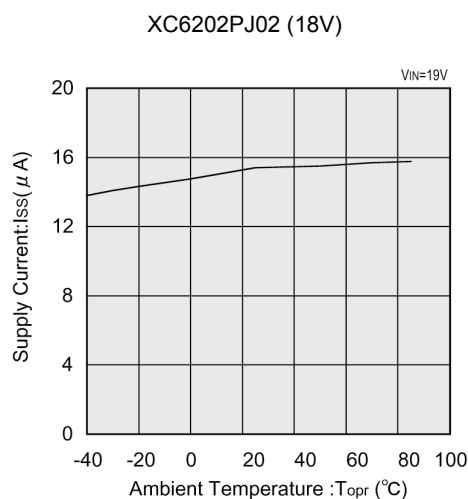

■ TYPICAL PERFORMANCE CHARACTERISTICS (Continued)

● XC6202PJ02 (Continued)

(7) Current Limiter Circuit

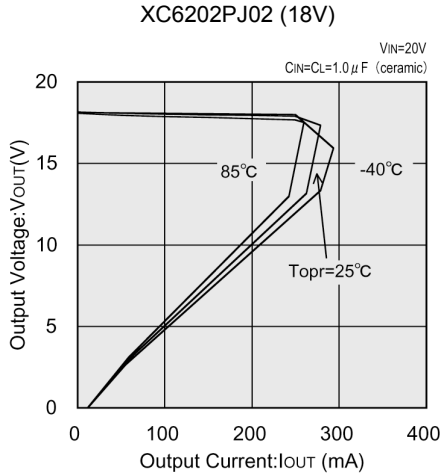

(8) Input Transient Response 1

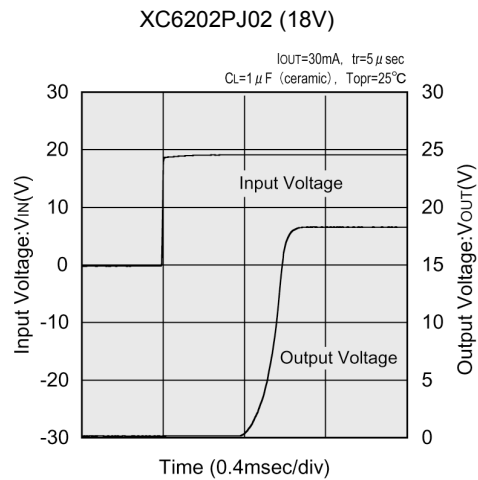
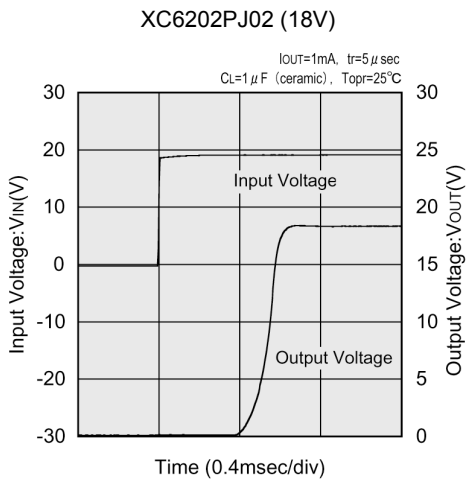

(9) Input Transient Response 2

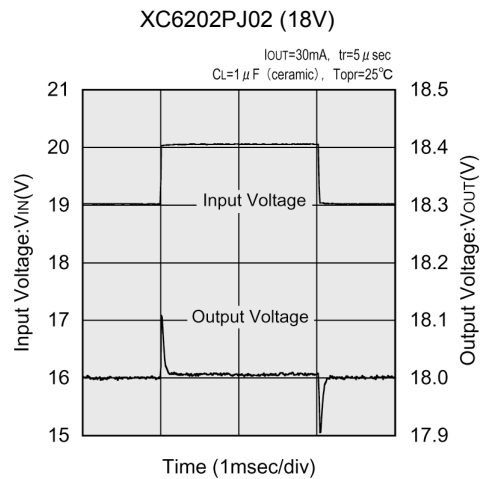
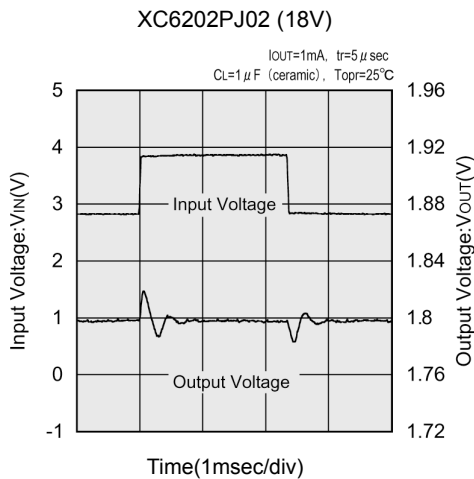

■ TYPICAL PERFORMANCE CHARACTERISTICS (Continued)

● XC6202PJ02 (Continued)

(10) Load Transient Response

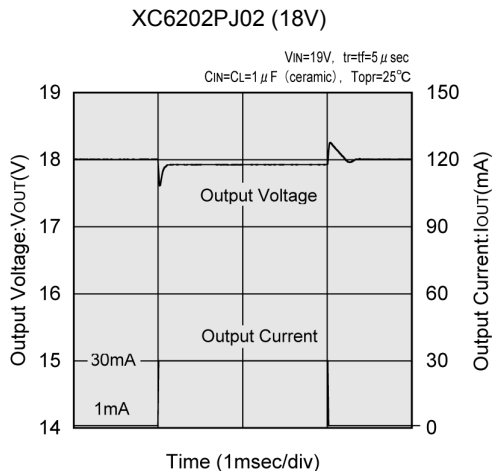

(11) Ripple Rejection Rate

