

# HIGH OPERATING VOLTAGE CMOS VOLTAGE REGULATOR

# S-812C Series

The S-812C series is a family of high-voltage positive regulators developed using CMOS technology. The maximum operating voltage of 16V makes the S-812C series best in high-voltage applications. Not only current consumption is small but also power-off function is included, the regulator is also suitable in constructing low-power portable devices. Combination of power-off function and short-current protection can be selected.

## ■ Features

- Low current consumption  
Operating current: Typ. 1.0  $\mu$ A, Max. 1.8  $\mu$ A (3.0 V)
- Output voltage: 2.0 to 6.0 V (0.1 V step)
- Output voltage accuracy:  $\pm 2.0\%$
- Output current:  
50mA capable (3.0 V output product,  $V_{IN}=5$  V) <sup>Note1</sup>  
75mA capable (5.0 V output product,  $V_{IN}=7$  V) <sup>Note1</sup>
- Dropout voltage  
Typ. 120 mV ( $V_{OUT} = 5.0$  V,  $I_{OUT} = 10$  mA)
- Power-off function: Polarity for power-off switch or removal of the power-off function can be selected.
- Short-circuit protection: Product with/without short-circuit protection is available.  
Short-circuited current : 40 mA typ. for products with protection
- Packages: SOT-23-5 (Package drawing code : MP005-A)  
SOT-89-5 (Package drawing code : UP003-A)  
SOT-89-3 (Package drawing code : UP005-A)  
TO-92 (Package drawing code : YF003-A)

Note1 Power dissipation of the package should be taken into account when the output current is large.

## ■ Applications

- Power source for battery-powered devices
- Power source for personal communication devices
- Power source for home electric/electronic appliances

## ■ Block Diagram

(1) Product without power-off function

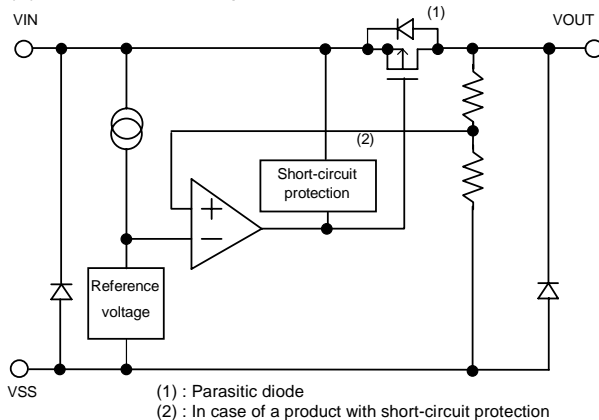

(2) Product with power-off function

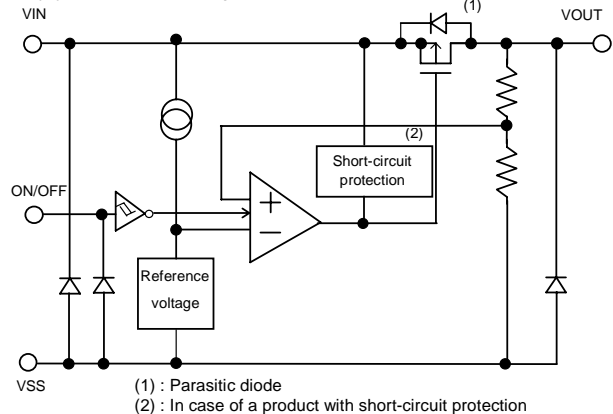

Figure 1 Block Diagram

■ Absolute Maximum Ratings

Table 1 (Ta=25°C unless otherwise specified)

Item	Symbol	Absolute Maximum Rating	Units
Input voltage	$V_{IN}$	18	V
	$V_{ON/OFF}$	$V_{SS}-0.3$ to 18	V
Output voltage	$V_{OUT}$	$V_{SS}-0.3$ to $V_{IN}+0.3$	V
Power dissipation	$P_D$	250(SOT-23-5),500 (SOT-89-5) 500(SOT-89-3),400(TO-92)	mW
Operating temperature range	$T_{opr}$	-40 to +85	°C
Storage temperature range	$T_{stg}$	-40 to +125	°C

Note: Although the IC contains protection circuit against static electricity, excessive static electricity or voltage which exceeds the limit of the protection circuit should not be applied to.

■ Selection Guide

Product Name

S-812C xx Axx - xxx - T2

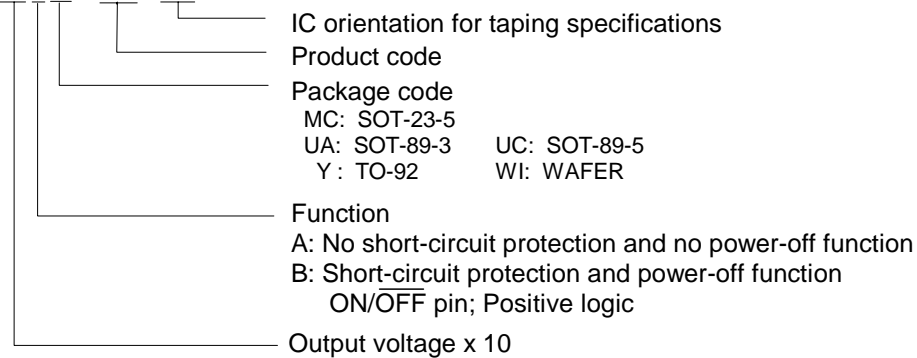

Table 2.1 Selection Guide

S-812CxxB series (Short-circuit protection and power-off fuction)

Output Voltage	SOT-23-5	SOT-89-5
2.0 V ± 2.0%	-	-
3.0 V ± 2.0%	S-812C30BMC-C4K-T2	-
3.3 V ± 2.0%	-	-
3.5 V ± 2.0%	-	-
3.8 V ± 2.0%	-	-
4.0 V ± 2.0%	-	-
5.0 V ± 2.0%	S-812C50BMC-C5E-T2	-

Please contact our sales office for products with an output voltage not listed above.

Table 2.2

S-812CxxA series (No short-circuit protection and no power-off function)

Output voltage	SOT-23-5	SOT-89-3	TO-92*	SOT-89-5
2.0 V $\pm$ 2.0%	S-812C20AMC-C2A-T2	S-812C20AUA-C2A-T2	S-812C20AY-X	—
2.1 V $\pm$ 2.0%	S-812C21AMC-C2B-T2	S-812C21AUA-C2B-T2	S-812C21AY-X	—
2.2 V $\pm$ 2.0%	S-812C22AMC-C2C-T2	S-812C22AUA-C2C-T2	S-812C22AY-X	—
2.3 V $\pm$ 2.0%	S-812C23AMC-C2D-T2	S-812C23AUA-C2D-T2	S-812C23AY-X	—
2.4 V $\pm$ 2.0%	S-812C24AMC-C2E-T2	S-812C24AUA-C2E-T2	S-812C24AY-X	—
2.5 V $\pm$ 2.0%	S-812C25AMC-C2F-T2	S-812C25AUA-C2F-T2	S-812C25AY-X	—
2.6 V $\pm$ 2.0%	S-812C26AMC-C2G-T2	S-812C26AUA-C2G-T2	S-812C26AY-X	—
2.7 V $\pm$ 2.0%	S-812C27AMC-C2H-T2	S-812C27AUA-C2H-T2	S-812C27AY-X	—
2.8 V $\pm$ 2.0%	S-812C28AMC-C2I-T2	S-812C28AUA-C2I-T2	S-812C28AY-X	—
2.9 V $\pm$ 2.0%	S-812C29AMC-C2J-T2	S-812C29AUA-C2J-T2	S-812C29AY-X	—
3.0 V $\pm$ 2.0%	S-812C30AMC-C2K-T2	S-812C30AUA-C2K-T2	S-812C30AY-X	—
3.1 V $\pm$ 2.0%	S-812C31AMC-C2L-T2	S-812C31AUA-C2L-T2	S-812C31AY-X	—
3.2 V $\pm$ 2.0%	S-812C32AMC-C2M-T2	S-812C32AUA-C2M-T2	S-812C32AY-X	—
3.3 V $\pm$ 2.0%	S-812C33AMC-C2N-T2	S-812C33AUA-C2N-T2	S-812C33AY-X	—
3.4 V $\pm$ 2.0%	S-812C34AMC-C2O-T2	S-812C34AUA-C2O-T2	S-812C34AY-X	—
3.5 V $\pm$ 2.0%	S-812C35AMC-C2P-T2	S-812C35AUA-C2P-T2	S-812C35AY-X	—
3.6 V $\pm$ 2.0%	S-812C36AMC-C2Q-T2	S-812C36AUA-C2Q-T2	S-812C36AY-X	—
3.7 V $\pm$ 2.0%	S-812C37AMC-C2R-T2	S-812C37AUA-C2R-T2	S-812C37AY-X	—
3.8 V $\pm$ 2.0%	S-812C38AMC-C2S-T2	S-812C38AUA-C2S-T2	S-812C38AY-X	—
3.9 V $\pm$ 2.0%	S-812C39AMC-C2T-T2	S-812C39AUA-C2T-T2	S-812C39AY-X	—
4.0 V $\pm$ 2.0%	S-812C40AMC-C2U-T2	S-812C40AUA-C2U-T2	S-812C40AY-X	—
4.1 V $\pm$ 2.0%	S-812C41AMC-C2V-T2	S-812C41AUA-C2V-T2	S-812C41AY-X	—
4.2 V $\pm$ 2.0%	S-812C42AMC-C2W-T2	S-812C42AUA-C2W-T2	S-812C42AY-X	—
4.3 V $\pm$ 2.0%	S-812C43AMC-C2X-T2	S-812C43AUA-C2X-T2	S-812C43AY-X	—
4.4 V $\pm$ 2.0%	S-812C44AMC-C2Y-T2	S-812C44AUA-C2Y-T2	S-812C44AY-X	—
4.5 V $\pm$ 2.0%	S-812C45AMC-C2Z-T2	S-812C45AUA-C2Z-T2	S-812C45AY-X	—
4.6 V $\pm$ 2.0%	S-812C46AMC-C3A-T2	S-812C46AUA-C3A-T2	S-812C46AY-X	—
4.7 V $\pm$ 2.0%	S-812C47AMC-C3B-T2	S-812C47AUA-C3B-T2	S-812C47AY-X	—
4.8 V $\pm$ 2.0%	S-812C48AMC-C3C-T2	S-812C48AUA-C3C-T2	S-812C48AY-X	—
4.9 V $\pm$ 2.0%	S-812C49AMC-C3D-T2	S-812C49AUA-C3D-T2	S-812C49AY-X	—
5.0 V $\pm$ 2.0%	S-812C50AMC-C3E-T2	S-812C50AUA-C3E-T2	S-812C50AY-X	—
5.1 V $\pm$ 2.0%	S-812C51AMC-C3F-T2	S-812C51AUA-C3F-T2	S-812C51AY-X	—
5.2 V $\pm$ 2.0%	S-812C52AMC-C3G-T2	S-812C52AUA-C3G-T2	S-812C52AY-X	—
5.3 V $\pm$ 2.0%	S-812C53AMC-C3H-T2	S-812C53AUA-C3H-T2	S-812C53AY-X	—
5.4 V $\pm$ 2.0%	S-812C54AMC-C3I-T2	S-812C54AUA-C3I-T2	S-812C54AY-X	—
5.5 V $\pm$ 2.0%	S-812C55AMC-C3J-T2	S-812C55AUA-C3J-T2	S-812C55AY-X	—
5.6 V $\pm$ 2.0%	S-812C56AMC-C3K-T2	S-812C56AUA-C3K-T2	S-812C56AY-X	—
5.7 V $\pm$ 2.0%	—	S-812C57AUA-C3L-T2	S-812C57AY-X	—
5.8 V $\pm$ 2.0%	—	S-812C58AUA-C3M-T2	S-812C58AY-X	—
5.9 V $\pm$ 2.0%	—	S-812C59AUA-C3N-T2	S-812C59AY-X	—
6.0 V $\pm$ 2.0%	—	S-812C60AUA-C3O-T2	S-812C60AY-X	—

\*: X changes according to the packing form in TO-92. Standard forms are B; Bulk and Z; Zigzag (tape and ammo).  
If tape and reel (T) is needed, please contact SII sales office.

■ Pin Configuration

For details of package, refer to the attached drawing.

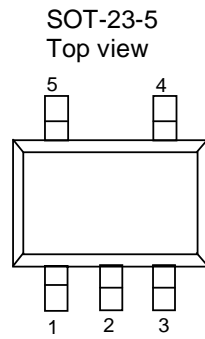

Figure 2

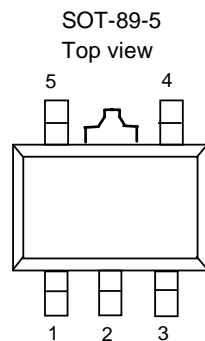

Figure 3

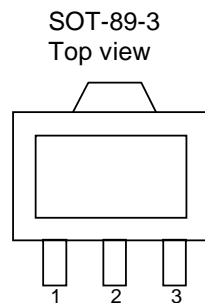

Figure 4

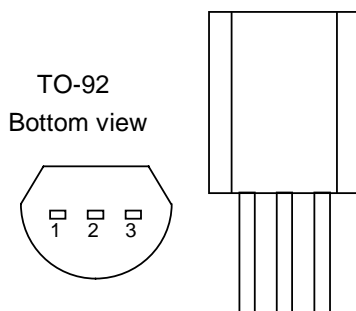

Figure 5

Table 3 Pin Assignment

Pin No.	Symbol	Description
1	VSS	GND pin
2	VIN	Input voltage pin
3	VOUT	Output voltage pin
4	N.C. <sup>(1)</sup>	—
5	ON/OFF	ON/OFF pin
	N.C. <sup>(1)</sup>	—

(1) N.C. pin is electrically open. N.C. pin can be connected to VIN or VSS. The ON/OFF pin becomes N.C. pin, when the power-off function is removed.

Table 4 Pin Assignment

Pin No.	Symbol	Description
1	VOUT	Output voltage pin
2	VIN	Input voltage pin
3	VSS	GND pin
4	ON/OFF	ON/OFF pin
	N.C. <sup>(1)</sup>	—
5	N.C. <sup>(1)</sup>	—

(1) N.C. pin is electrically open. N.C. pin can be connected to VIN or VSS. The ON/OFF pin becomes N.C. pin, when the power-off function is removed.

Table 5 Pin Assignment

Pin No.	Symbol	Description
1	VSS	GND pin
2	VIN	Input voltage pin
3	VOUT	Output voltage pin

Table 6 Pin Assignment

Pin No.	Symbol	Description
1	VSS	GND pin
2	VIN	Input voltage pin
3	VOUT	Output voltage pin

## ■ Electrical Characteristics

## 1. S-812C Series

Table 7 Electrical Characteristics (Ta=25°C unless otherwise specified)

Parameter	Symbol	Conditions	Min.	Typ.	Max.	Units	Test circuits	
Output voltage 1)	$V_{OUT(E)}$	$V_{IN}=V_{OUT(S)}+2V, I_{OUT}=10mA$	$V_{OUT(S)} \times 0.98$	$V_{OUT(S)}$	$V_{OUT(S)} \times 1.02$	V	1	
Output current 2)	$I_{OUT}$	$V_{OUT(S)}+2V \leq V_{IN} \leq 16V$	$2.0V \leq V_{OUT(S)} \leq 2.9V$	30	–	–	mA	3
			$3.0V \leq V_{OUT(S)} \leq 3.9V$	50	–	–	mA	3
			$4.0V \leq V_{OUT(S)} \leq 4.9V$	65	–	–	mA	3
			$5.0V \leq V_{OUT(S)} \leq 5.9V$	75	–	–	mA	3
Dropout voltage 3)	$V_{drop}$	$I_{OUT} = 10mA$	$2.0V \leq V_{OUT(S)} \leq 2.4V$	–	0.46	0.95	V	1
			$2.5V \leq V_{OUT(S)} \leq 2.9V$	–	0.32	0.68	V	1
			$3.0V \leq V_{OUT(S)} \leq 3.4V$	–	0.23	0.41	V	1
			$3.5V \leq V_{OUT(S)} \leq 3.9V$	–	0.19	0.35	V	1
			$4.0V \leq V_{OUT(S)} \leq 4.4V$	–	0.16	0.30	V	1
			$4.5V \leq V_{OUT(S)} \leq 4.9V$	–	0.14	0.27	V	1
			$5.0V \leq V_{OUT(S)} \leq 5.4V$	–	0.12	0.25	V	1
		$5.5V \leq V_{OUT(S)} \leq 6.0V$	–	0.11	0.23	V	1	
Line regulation 1	$\Delta V_{OUT1}$	$V_{OUT(S)} + 1V \leq V_{IN} \leq 16V, I_{OUT} = 1mA$	–	5	20	mV	1	
Line regulation 2	$\Delta V_{OUT2}$	$V_{OUT(S)} + 1V \leq V_{IN} \leq 16V, I_{OUT} = 1\mu A$	–	5	20	mV	1	
Load regulation	$\Delta V_{OUT3}$	$V_{IN} = V_{OUT(S)} + 2V, 1\mu A \leq I_{OUT} \leq 20mA$	$2.0V \leq V_{OUT(S)} \leq 2.9V, 1\mu A \leq I_{OUT} \leq 20mA$	–	6	30	mV	1
			$3.0V \leq V_{OUT(S)} \leq 3.9V, 1\mu A \leq I_{OUT} \leq 30mA$	–	10	45	mV	1
			$4.0V \leq V_{OUT(S)} \leq 4.9V, 1\mu A \leq I_{OUT} \leq 40mA$	–	13	65	mV	1
			$5.0V \leq V_{OUT(S)} \leq 5.9V, 1\mu A \leq I_{OUT} \leq 50mA$	–	17	80	mV	1
Output voltage temperature coefficient 4)	$\frac{\Delta V_{OUT}}{\Delta T_a \cdot V_{OUT}}$	$V_{IN} = V_{OUT(S)} + 1V, I_{OUT} = 10mA, -40^\circ C \leq T_a \leq 85^\circ C$	–	$\pm 100$	–	ppm/ $^\circ C$	1	
Current consumption	$I_{SS}$	$V_{IN} = V_{OUT(S)} + 2V, no load$	$2.0V \leq V_{OUT(S)} \leq 2.7V$	–	0.9	1.6	$\mu A$	2
			$2.8V \leq V_{OUT(S)} \leq 3.7V$	–	1.0	1.8	$\mu A$	2
			$3.8V \leq V_{OUT(S)} \leq 5.1V$	–	1.2	2.1	$\mu A$	2
			$5.2V \leq V_{OUT(S)} \leq 6.0V$	–	1.5	2.5	$\mu A$	2
Input voltage	$V_{IN}$		–	–	16	V	1	
<b>Applied to products with Power-off Function</b>								
Current consumption at power-off	$I_{SS2}$	$V_{IN} = V_{OUT(S)} + 2V, V_{ON/OFF} = 0V, no load$	–	0.1	0.5	$\mu A$	2	
ON/OFF pin Input voltage for high level	$V_{SH}$	$V_{IN} = V_{OUT(S)} + 2V, R_L = 1k\Omega, judged by V_{OUT} output level$	2.0	–	–	V	4	
ON/OFF pin Input voltage for low level	$V_{SL}$	$V_{IN} = V_{OUT(S)} + 2V, R_L = 1k\Omega, judged by V_{OUT} output level$	–	–	0.4	V	4	
ON/OFF pin Input current at high level	$I_{SH}$	$V_{IN} = V_{OUT(S)} + 2V, V_{ON/OFF} = 7V$	–	–	0.1	$\mu A$	4	
ON/OFF pin Input current at low level	$I_{SL}$	$V_{IN} = V_{OUT(S)} + 2V, V_{ON/OFF} = 0V$	–	–	-0.1	$\mu A$	4	
<b>Applied to products with Short-circuit Protection</b>								
Short-circuit current	$I_{OS}$	$V_{IN} = V_{OUT(S)} + 2V, V_{OUT} pin = 0V$	–	40	–	mA	3	

- $V_{OUT(S)}$ =Specified output voltage  
 $V_{OUT(E)}$ =Effective output voltage, i.e., the output voltage when fixing  $I_{OUT}(=10mA)$  and inputting  $V_{OUT(S)}+2.0V$ .
- Output current at which output voltage becomes 95% of  $V_{OUT(E)}$  after gradually increasing output current.
- $V_{drop} = V_{IN1} - (V_{OUT(E)} \times 0.98)$ , where  $V_{IN1}$  is the Input voltage at which output voltage becomes 98% of  $V_{OUT(E)}$  after gradually decreasing input voltage.
- Temperature change ratio for the output voltage [mV/ $^\circ C$ ] is calculated using the following equation.

$$\frac{\Delta V_{OUT}}{\Delta T_a} [mV/^\circ C] = V_{OUT(S)} [V] \times \frac{\Delta V_{OUT}}{\Delta T_a \cdot V_{OUT}} [ppm/^\circ C] \div 1000$$

Temperature change ratio for output voltage

Specified output voltage

Output voltage temperature coefficient

■ Test Circuits

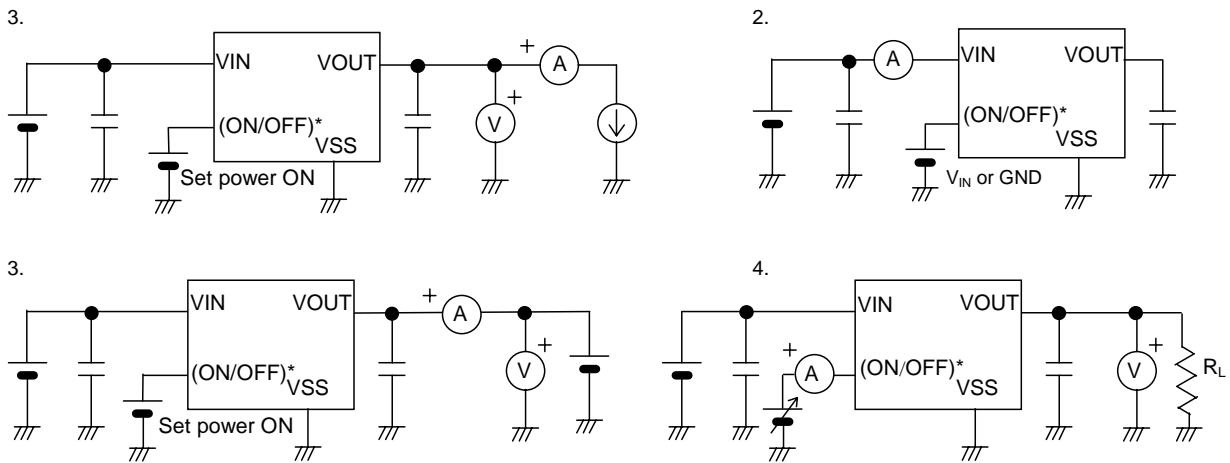

Figure 6 Test Circuits

■ Standard Circuit

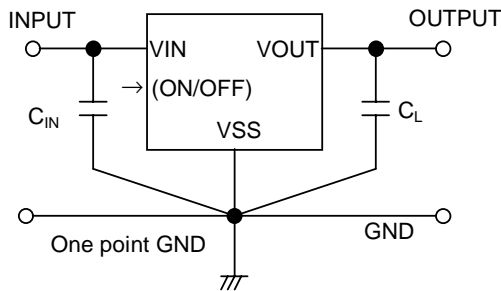

Figure 7 Standard Circuit

In addition to a tantalum capacitor, a ceramic capacitor can be used for  $C_L$ . See terms below.  
 $C_{IN}$  is a capacitor used to stabilize input.

■ Terms

1. Output capacitors ( $C_L$ )

Output capacitors are generally used to stabilize regulation operation and to improve transient response characteristics. But the S-812C series can provide stable operation without output capacitors. Capacitors are used only to improve transient response characteristics. Output capacitors can hence be removed in applications in which transient response can be negligible. When an output capacitor is used, a low ESR (Equivalent Series Resistance) capacitor like ceramic capacitor can also be used.

2. Output voltage ( $V_{OUT}$ )

The accuracy of the output voltage is  $\pm 2.0\%$  guaranteed under the specified conditions for input voltage, which differs depending upon the product items, output current, and temperature.

Note: If the above conditions change, the output voltage value may vary and go out of the accuracy range of the output voltage. See the electrical characteristics and characteristics data for details.

3. Line regulations 1 and 2 ( $\Delta V_{OUT1}$ ,  $\Delta V_{OUT2}$ )

These parameters indicate the input voltage dependence on the output voltage. That is, the values show how much the output voltage changes due to a change in the input voltage with the output current remained unchanged.

4. Load regulation ( $\Delta V_{OUT3}$ )

This parameter indicates the output current dependence on the output voltage. That is, the value shows how much the output voltage changes due to a change in the output current with the input voltage remained unchanged.

5. Dropout voltage (Vdrop)

This parameter indicates the difference between the input voltage (VIN1) and the output voltage when output voltage falls to 98 % of VOUT (E) by gradually decreasing the input voltage (VIN).

$$V_{drop} = V_{IN1} - [V_{OUT(E)} \times 0.98]$$

6. Temperature coefficient of output voltage [ $\Delta V_{OUT}/(\Delta T_a \cdot V_{OUT})$ ]

The output voltage lies in the shaded area in the whole operating temperature shown in figure 8 when the temperature coefficient of the output voltage is  $\pm 100$  ppm/ $^{\circ}C$ .

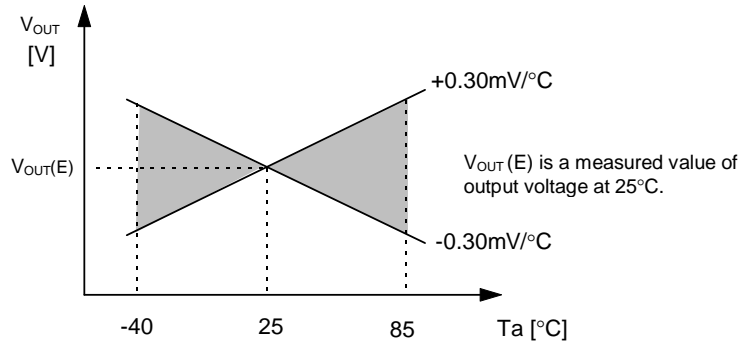

Figure 8 Example for the S-812C30A

Temperature change ratio for output voltage [mV/ $^{\circ}C$ ] is calculated by using the following equation.

$$\frac{\Delta V_{OUT}}{\Delta T_a} [mV/^{\circ}C] = V_{OUT(S)} [V] \times \frac{\Delta V_{OUT}}{\Delta T_a \cdot V_{OUT}} [ppm/^{\circ}C] \div 1000$$

↑
↑
↑

Temperatures change ratio for output voltage

Specified output voltage

Output voltage temperature coefficient

■ Description of Operation

1. Basic operation

Figure 9 shows the block diagram of the S-812C series.

The error amplifier compares a reference voltage  $V_{ref}$  with a part of the output voltage divided by the feedback resistors  $R_s$  and  $R_f$ , and supplies the gate voltage to the output transistor, necessary to ensure certain output voltage independent from change of input voltage and temperature.

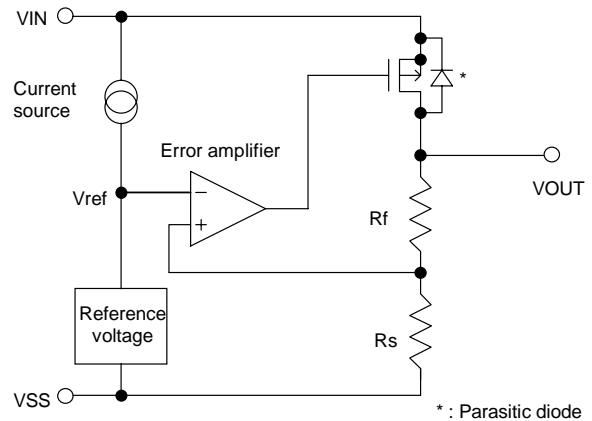

Figure 9 Block Diagram

2. Output transistor

The S-812C Series uses a Pch MOS transistor as the output transistor.

The voltage at VOUT must not exceed  $V_{IN} + 0.3V$ . When the VOUT voltage becomes higher than that of  $V_{IN}$ , reverse current flows and may break the regulator since a parasitic diode between VOUT and  $V_{IN}$  exists inevitably.

3. Power-off function (ON/OFF pin)

The ON/OFF pin controls the start and stop of the regulation operation.

When the ON/OFF pin is set to power-off level, halting whole internal circuit and turning off the Pch MOSFET between VIN and VOUT, current consumption is drastically reduced. The voltage of the VOUT pin becomes VSS level due to the internal resistance divider of several MΩ between VOUT and VSS.

The ON/OFF pin should not be left afloat since no pull-up nor pull-down is made internally as shown in figure 10. Note that the current consumption increases if a voltage between 0.3V and VIN-0.3V is applied to the ON/OFF pin. When the power-off function is not used, connect the pin to the VIN pin in case of positive logic and to the VSS pin in case of negative logic.

Table 8 Power-off function

Product type	ON/OFF pin	Internal circuit	VOUT pin voltage	Current consumption
B	“H” : Power on	Operate	Set value	$I_{SS}$
B	“L” : Power off	Halt	V <sub>SS</sub> level	$I_{SS2}$

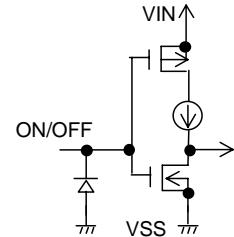

Figure 10

When a regulation operation at light load less than 100uA is halted, output voltage may increase. If the increase of the output voltage should be avoided, pull down the VOUT pin to the V<sub>SS</sub> level as soon as ON/OFF pin goes to the power-down level.

4. Short-circuit protection

Installation of the short-circuit protection which protects the output transistor against short-circuit between VOUT and VSS can be selected in the S-812C series. The short-circuit protection controls output current as shown in the typical characteristics, (1) OUTPUT VOLTAGE versus OUTPUT CURRENT, and suppresses output current at about 40 mA even if VOUT and VSS pins are short-circuited.

The short-circuit protection can not at the same time be a thermal protection. Attention should be paid to the Input voltage and the load current under the actual condition so as not to exceed the power dissipation of the package including the case for short-circuit.

When the output current is large and the difference between input and output voltage is large even if not shorted, the short-circuit protection may work and the output current is suppressed to the specified value.

Products without short-circuit protection can provide comparatively large current by removing a short-circuit protection.

■ Selection of External Components

Output Capacitor (C<sub>L</sub>)

The S-812C series can provide stable operation without output capacitor (C<sub>L</sub>) since the regulator has an internal phase compensation circuit to stabilize operation when the load changes. The transient response of the regulator, however, changes with the output capacitor and the magnitude of overshoot and undershoot on output voltage accordingly changes. Please refer to C<sub>L</sub> dependence data in “Transient Response Characteristics” to select suitable value for the capacitor. .

When a tantalum or an aluminum electrolytic capacitor is used, the ESR of the capacitor shall be 10Ω or less. When an aluminum electrolytic capacitor is used attention should be especially paid to since the ESR of the aluminum electrolytic capacitor increases at low temperature and possibility of oscillation becomes large. Sufficient evaluation including temperature characteristics is indispensable.



## Application Circuits

### 1. Output Current Boost Circuit

As shown in Figure 11, the output current can be boosted by externally attaching a PNP transistor. The S-812C controls the base current of the PNP transistor so that the output voltage  $V_{OUT}$  becomes the voltage specified in the S-812C if the sufficient base-emitter voltage  $V_{BE}$  to turn on the PNP transistor is obtained between input voltage  $V_{IN}$  and S-812C power source pin  $V_{IN}$ .

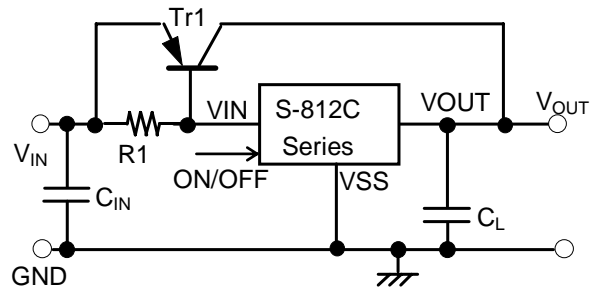

Figure 11 Output Current Boost Circuit

- As the transient response characteristics of the circuit shown in figure 11 is not enough in some applications, evaluation for output variation due to power-on, power line variation and load variation in actual condition is needed before massproduction.
- Note that the short-circuit protection incorporated in the S-812C series does not work as a short-circuit protection for the boost circuit.

### 2. Constant Current Circuit

The S-812C series can be served in a constant current circuit as shown in the figure 12. Constant current  $I_O$  is calculated from the following equation:

$I_O = (V_{OUT(E)} \div R_L) + I_{SS}$ , where  $V_{OUT(E)}$  is the effective output voltage.

Please note that in case of the circuit shown in the figure 12 (1) the magnitude of the constant current  $I_O$  is limited by the driving ability of the S-812C.

The circuit shown in the figure 12 (2) can, however, provide the current beyond the driving ability of the S-812C by combining a constant current circuit with a current boost circuit. The maximum input voltage for the constant current circuit is the sum of the voltage  $V_O$  of the device and 16 V. It is not recommended to attach a capacitor between the S-812C power source  $V_{IN}$  and  $V_{SS}$  pins or between output  $V_{OUT}$  and  $V_{SS}$  pins because rush current flows at power-on.

#### (1) Constant Current Circuit

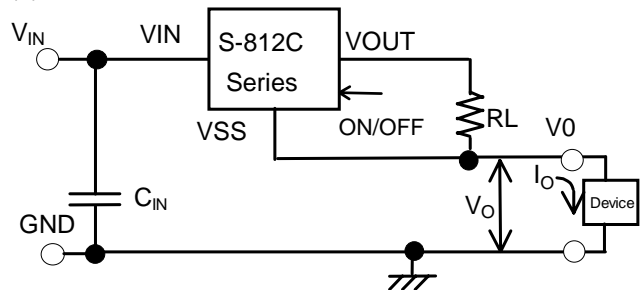

#### (2) Constant Current Boost Circuit

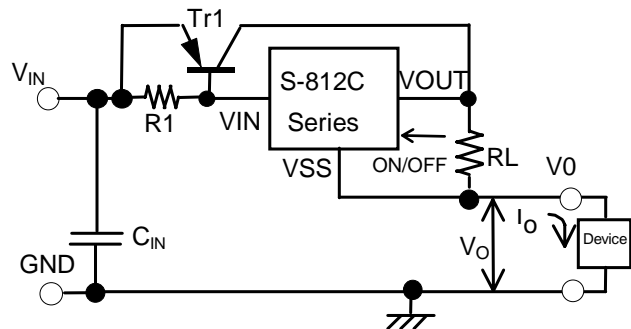

Figure 12 Constant Current Circuits

### 3. Output Voltage Adjustment Circuit

The output voltage can be increased using the configuration shown in the figure 13. The output Voltage  $V_{OUT1}$  can be calculated using the following equation;

$$V_{OUT1} = V_{OUT(E)} \times (R1 + R2) \div R1 + R2 \times I_{SS}$$

where  $V_{OUT(E)}$  is the effective output voltage.

Value of  $R1$  and  $R2$  should be determined so as not to be affected by the current consumption  $I_{SS}$ .

Capacitor C1 has an effect in minimizing output fluctuation due to power-on, power line variation and load variation. Determine the optimum value in the actual device.

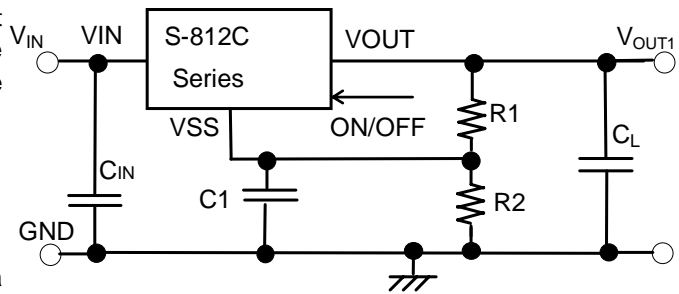

Figure 13 Voltage Adjustment Circuit

It is not also recommended to attach a capacitor between the S-812 power source VIN and VSS pins or between output VOUT and VSS pins because output fluctuation or oscillation at powering on might occur.

■ Notice

- Wiring patterns for VIN, VOUT and GND pins should be designed to hold low impedance.  
 When mounting an output capacitor, the distance from the capacitor to the VOUT pin and to the VSS pin should be as short as possible.
- Note that output voltage may increase when a voltage regulator is used at low load current (less than 1  $\mu$ A).
- At low load current less than 100 $\mu$ A output voltage may increase when the regulating operation is halted by the ON/OFF pin.
- To prevent oscillation, it is recommended to use the external components under the following conditions:  
 Equivalent Series Resistance (ESR): 10  $\Omega$  or less when an output capacitor is used.  
 Input series resistance (RIN): 10  $\Omega$  or less
- A voltage regulator may oscillate when the impedance of the power supply is high and the input capacitor is small or not connected.
- The application condition for input voltage and load current should not exceed the package power dissipation.
- SII claims no responsibility for any and all disputes arising out of or in connection with any infringement of the products including this IC upon patents owned by a third party.

■ Typical Characteristics

(1) Output Voltage vs Output Current (When load current increases)

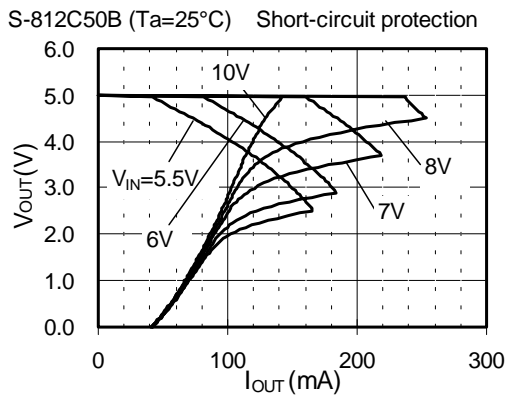
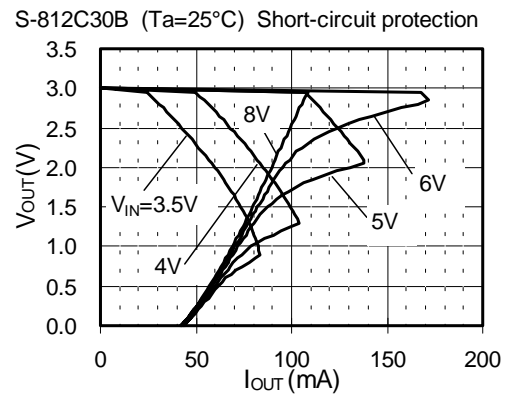
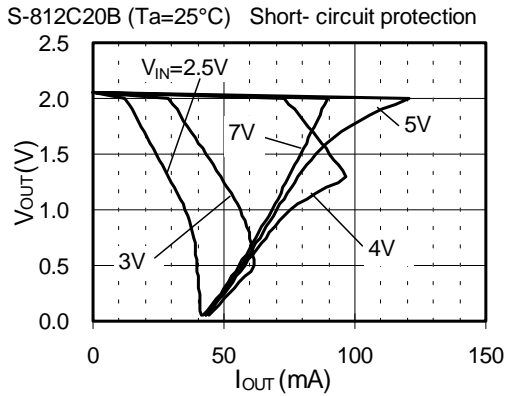

Notice  
The condition for input voltage and load current should not exceed the package power dissipation.

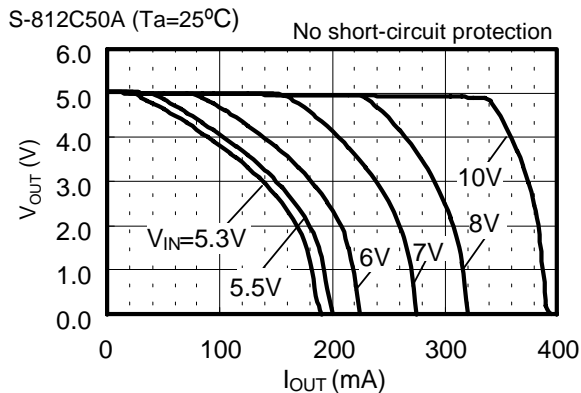
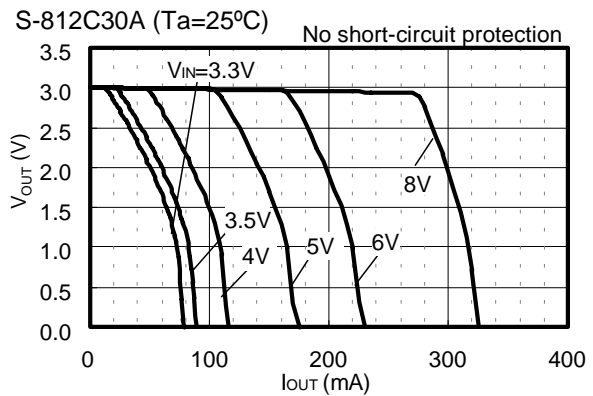
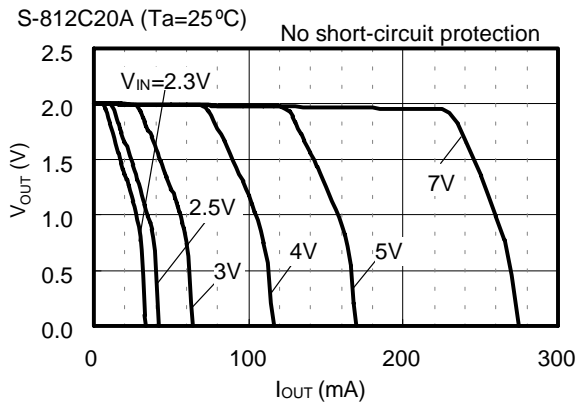

Notice  
The condition for input voltage and load current should not exceed the package power dissipation.

(2) Maximum Output Current vs Input Voltage

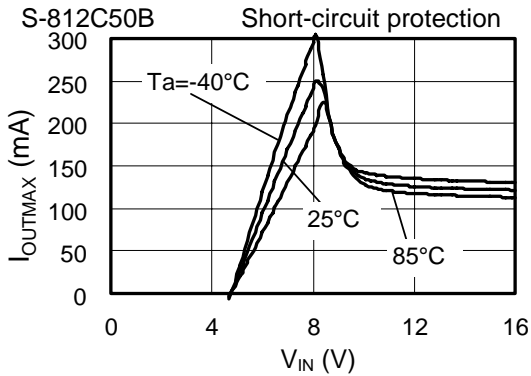
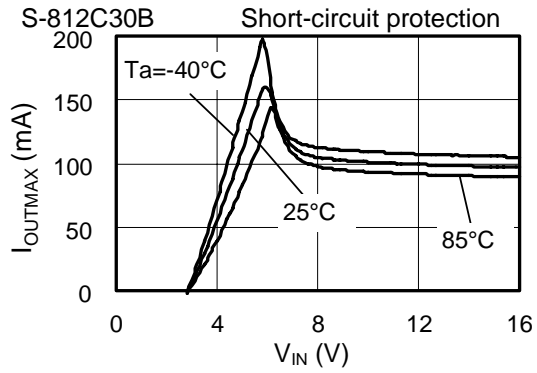
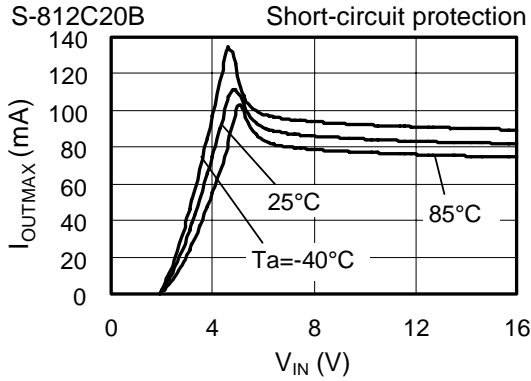

Notice  
 The condition for input voltage and load current should not exceed the package power dissipation.

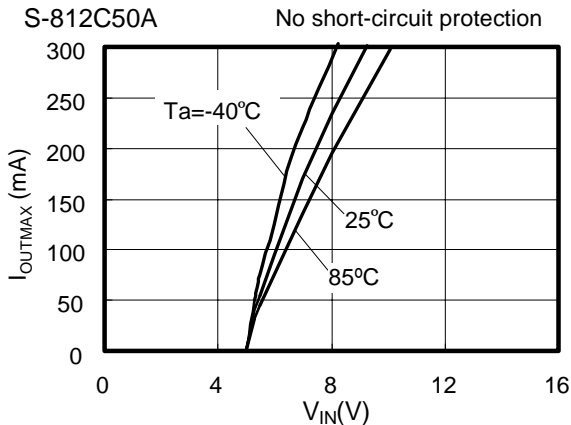
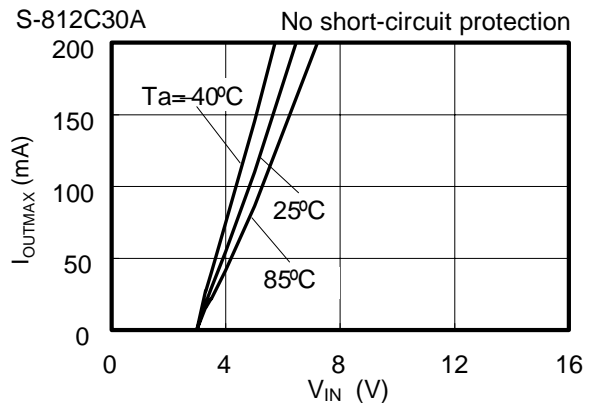
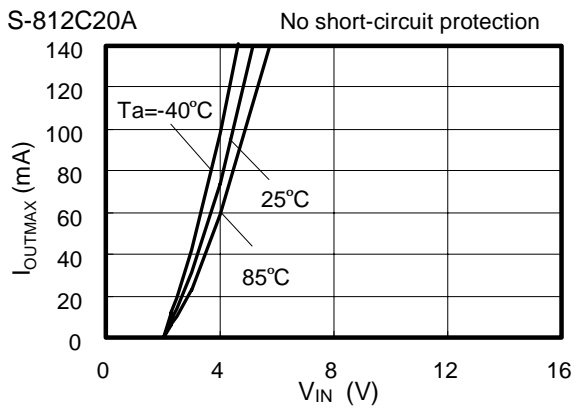

Notice  
 The condition for input voltage and load current should not exceed the package power dissipation.

(3) Output Voltage vs Input Voltage

S-812C20B

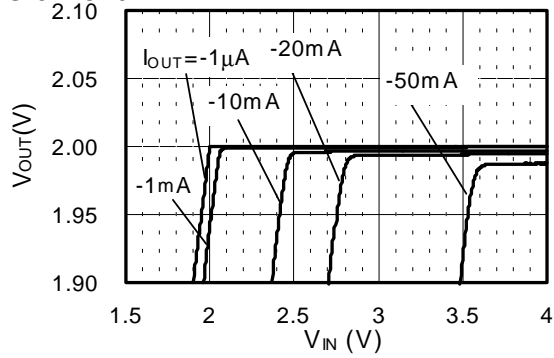

S-812C30B

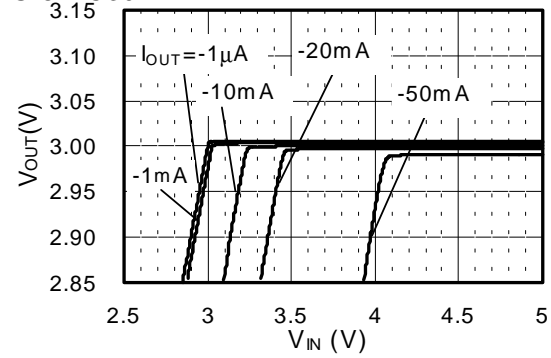

S-812C50B

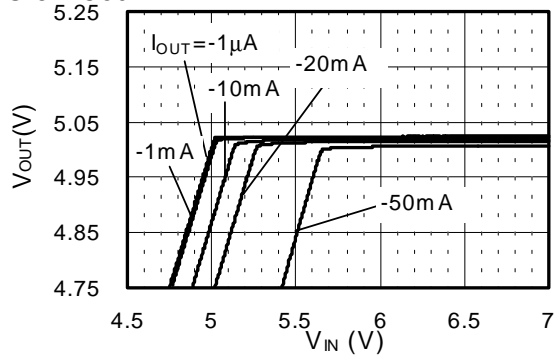

(4) Dropout Voltage vs Output Current

S-812C20B

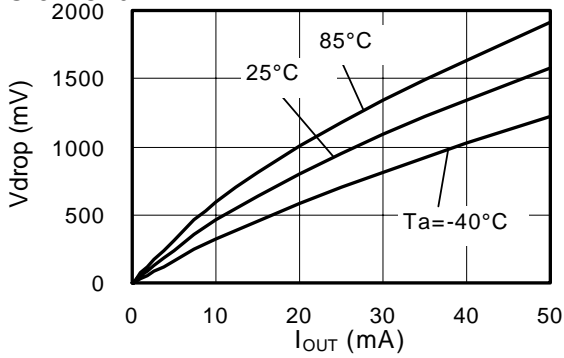

S-812C30B

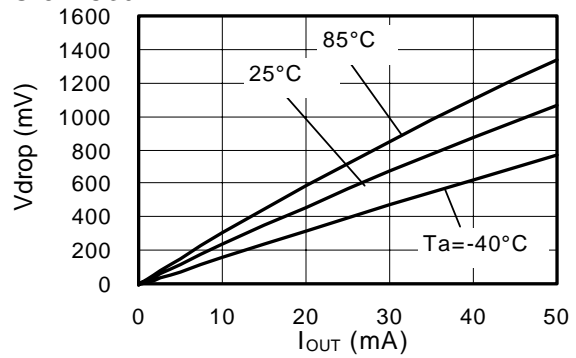

S-812C50B

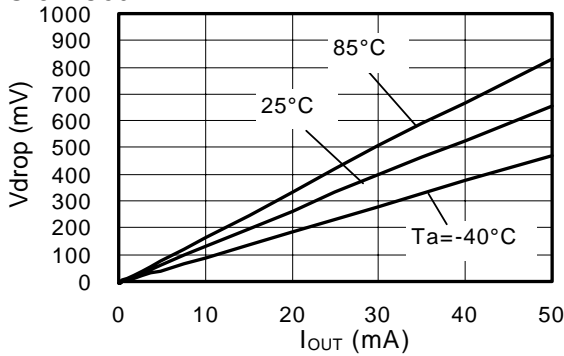

(5) Output Voltage vs Ambient Temperature

S-812C20B

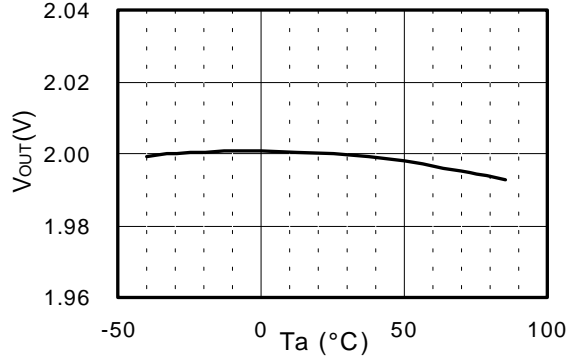

S-812C30B

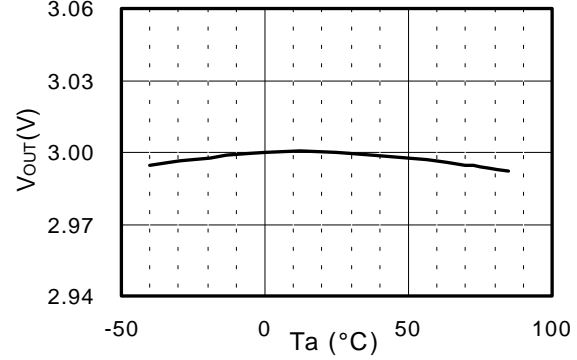

S-812C50B

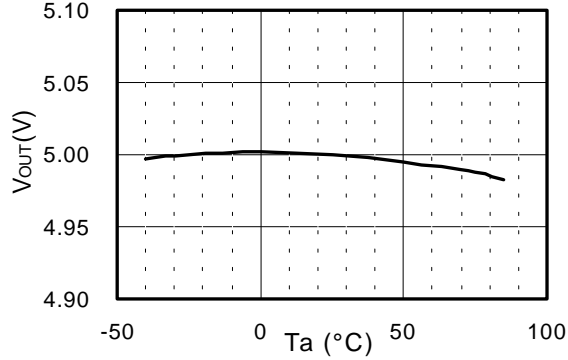

(6) Line Regulation 1 vs Ambient Temperature

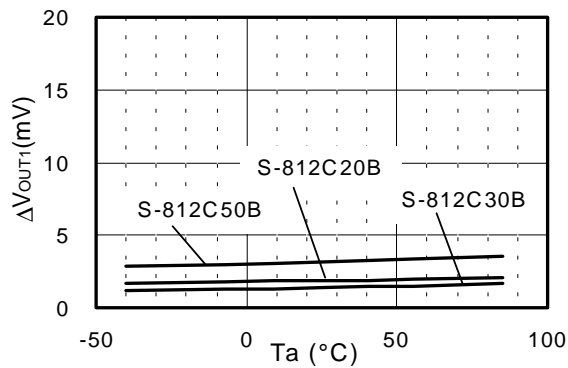

(7) Line Regulation 2 vs Ambient Temperature

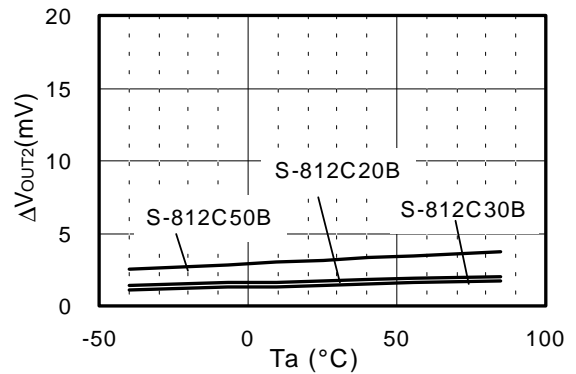

(8) Load Regulation vs Ambient Temperature

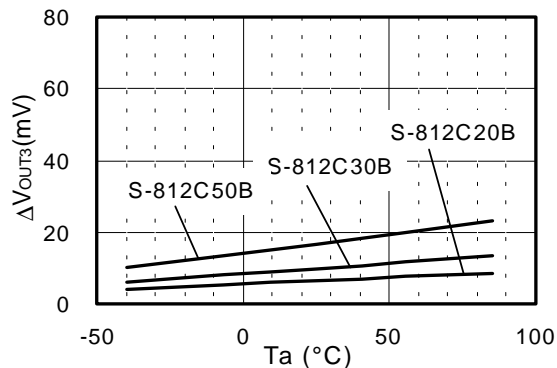

(9) Current Consumption vs Input Voltage

S-812C20B

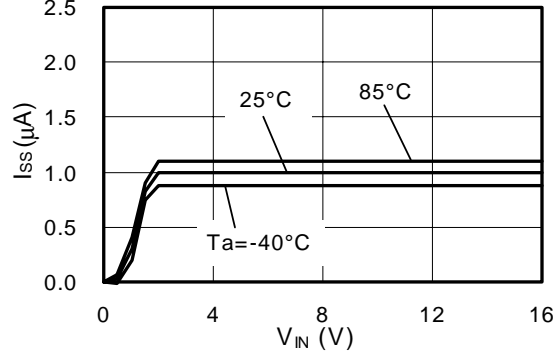

S-812C30B

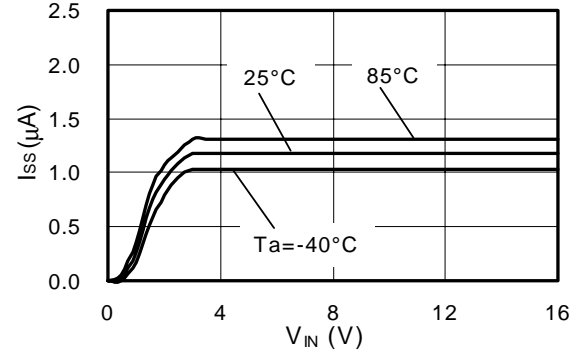

S-812C50B

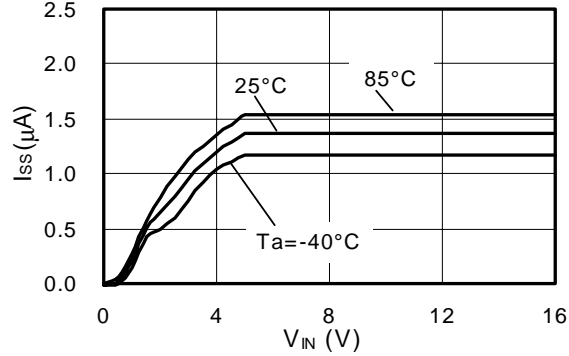

(10) Power-off Pin Input Threshold vs Input Voltage

S-812C20B

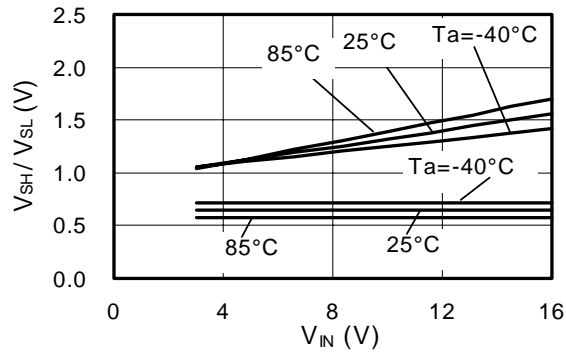

REFERENCE DATA

■ Transient Response Characteristics (Typical data:  $T_a=25^\circ\text{C}$ )

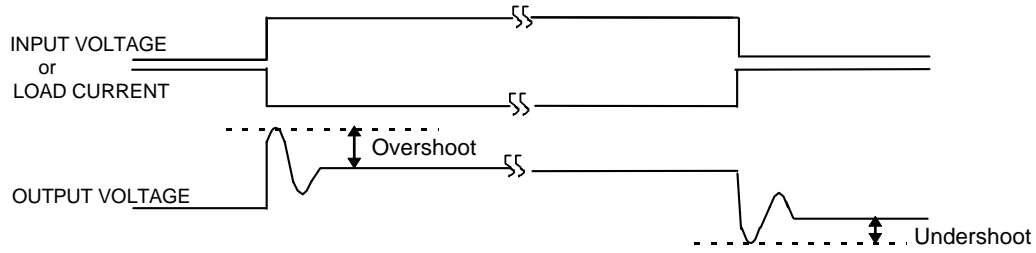

(1) Power-on : S-812C30B ( $C_L=10\mu\text{F}$ ; ceramic capacitor)

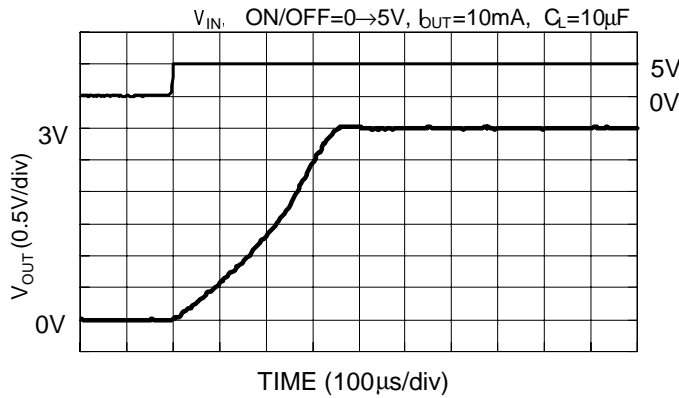

Load dependence of overshoot at power-on

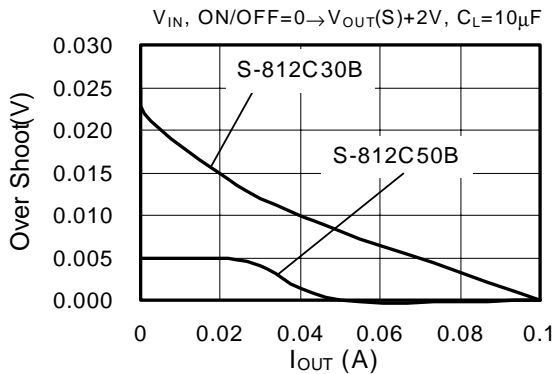

$C_L$  dependence of overshoot at power-on

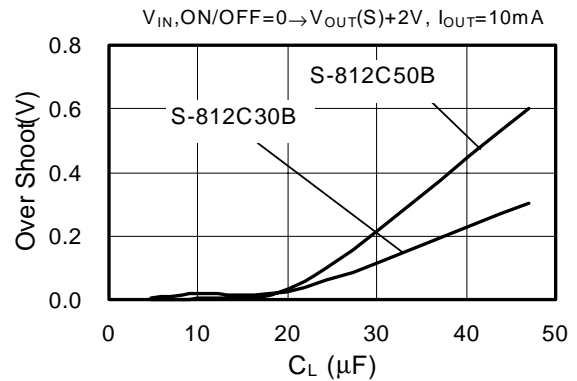

$V_{DD}$  dependence of overshoot at power-on

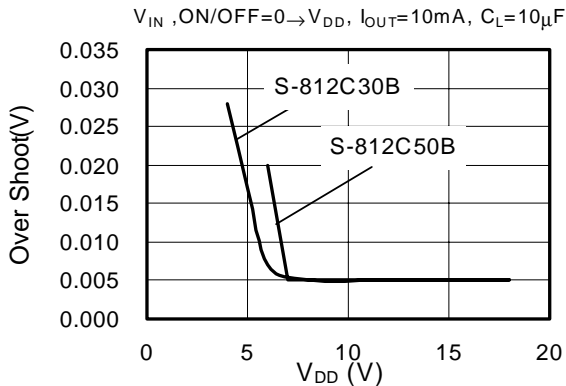

Temperature dependence of overshoot at power-on

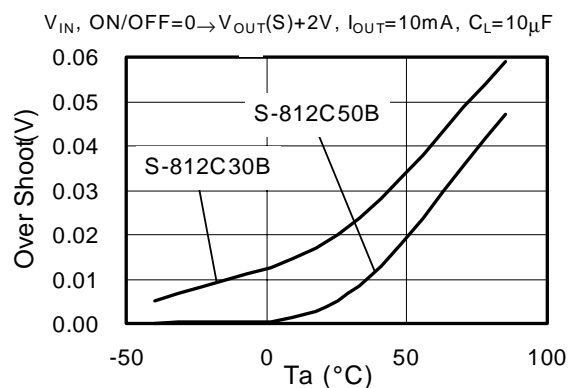



(2) Power-on by ON/OFF pin : S-812C30A ( $C_L=10\mu\text{F}$ ; ceramic capacitor)

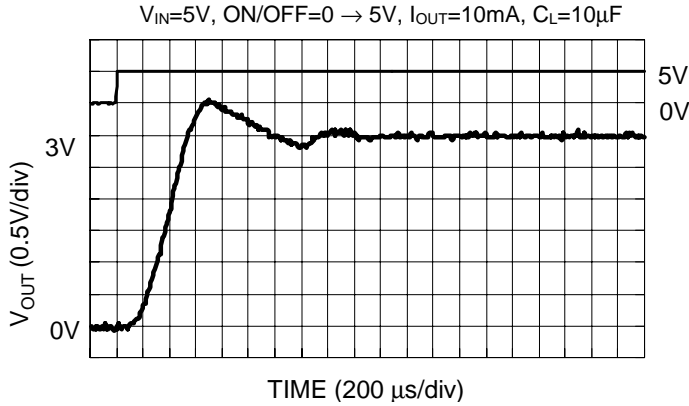

Load dependence of overshoot at power-on

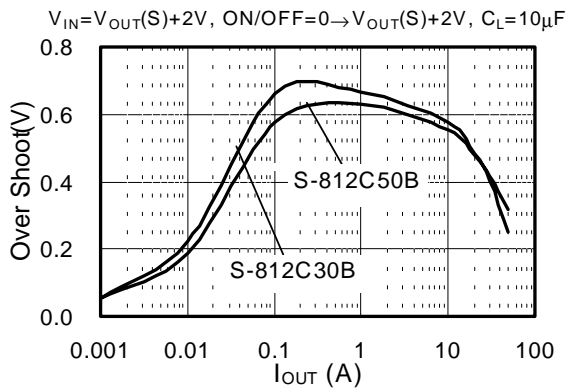

$C_L$  dependence of overshoot at power-on

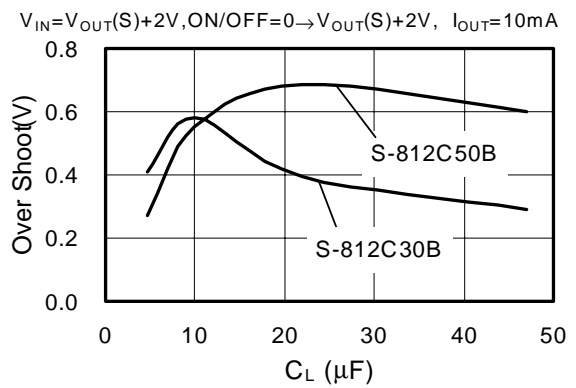

$V_{DD}$  dependence of overshoot at power-on

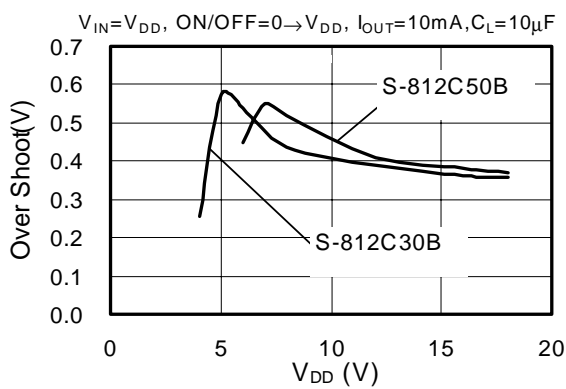

Temperature dependence of overshoot at power-on

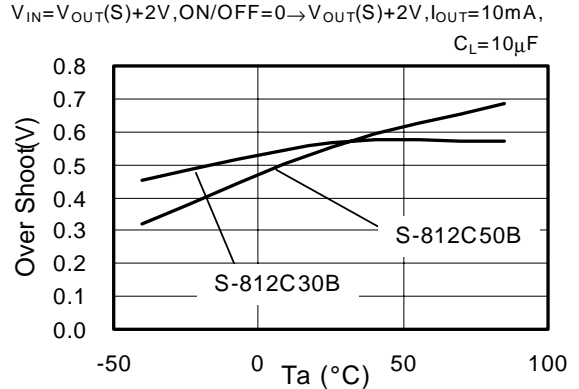

(3) Line Transient Response : S-812C30B ( $C_L=10\mu\text{F}$ ; ceramic capacitor)

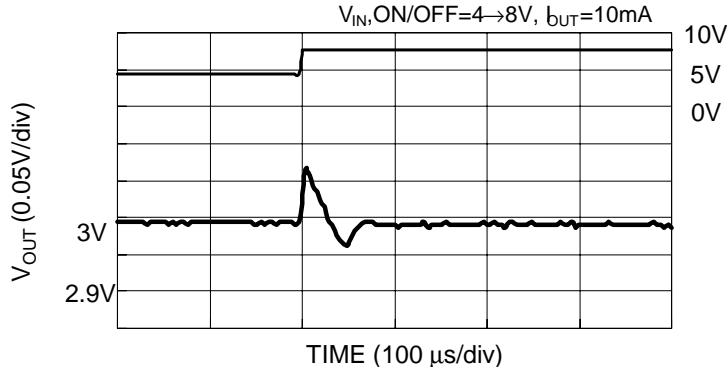

Load dependence of overshoot at line transient

$V_{IN, ON/OFF}=V_{OUT(S)}+1\text{V}\rightarrow V_{OUT(S)}+5\text{V}$ ,  
 $C_L=10\mu\text{F}$

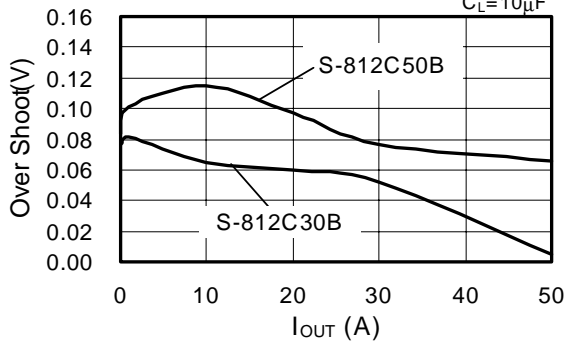

$C_L$  dependence of overshoot at line transient

$V_{IN, ON/OFF}=V_{OUT(S)}+1\text{V}\rightarrow V_{OUT(S)}+5\text{V}$ ,  $I_{OUT}=10\text{mA}$

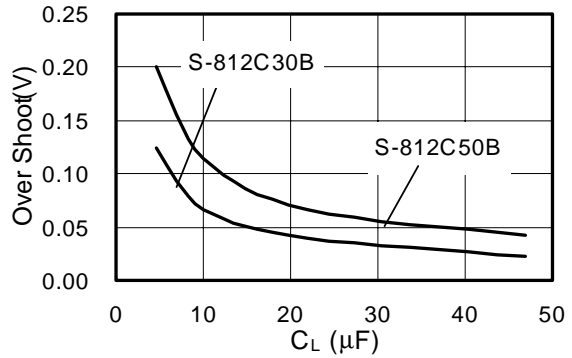

$V_{DD}$  dependence of overshoot at line transient

$V_{IN, ON/OFF}=V_{OUT(S)}+1\text{V}\rightarrow V_{DD}$   $I_{OUT}=10\text{mA}$   $C_L=10\mu\text{F}$

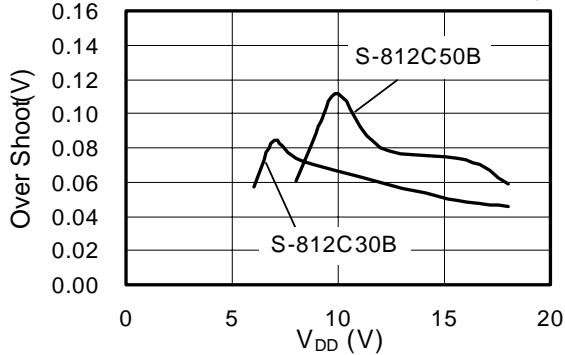

Temperature dependence of overshoot at line transient

$V_{IN, ON/OFF}=V_{OUT(S)}+1\text{V}\rightarrow V_{OUT(S)}+5\text{V}$ ,  
 $I_{OUT}=10\text{mA}$   $C_L=10\mu\text{F}$

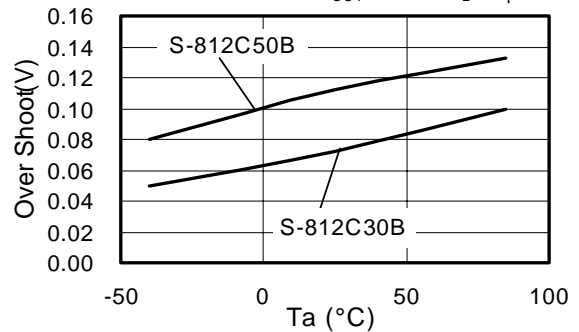

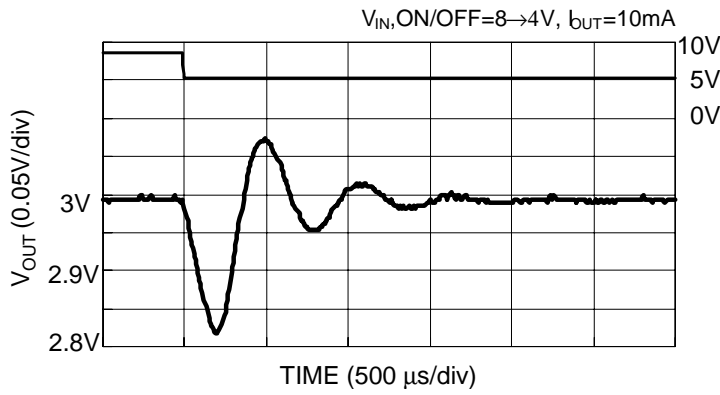

Load dependence of undershoot at line transient

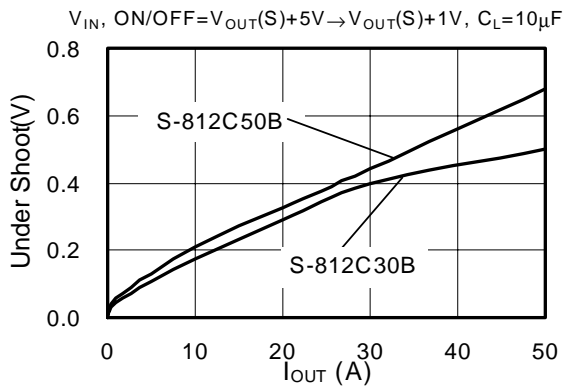

$C_L$  dependence of undershoot at line transient

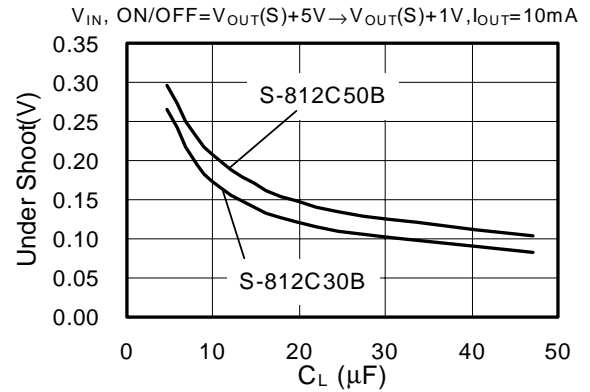

$V_{DD}$  dependence of undershoot at line transient

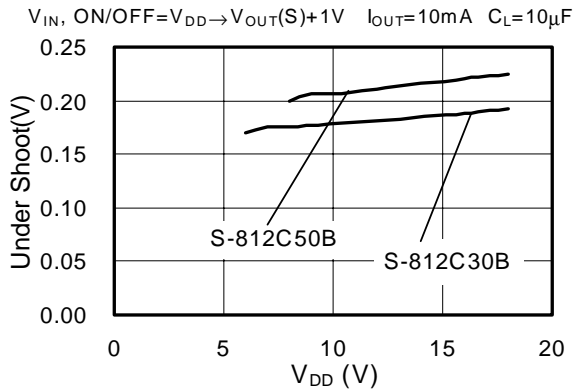

Temperature dependence of undershoot at line transient

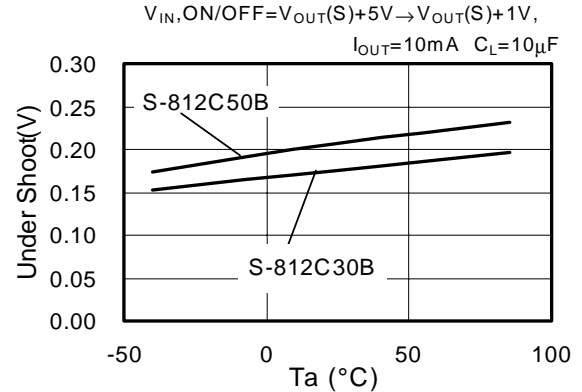

(4) Load Transient Response : S-812C30B ( $C_L=10\mu\text{F}$ ; ceramic capacitor)

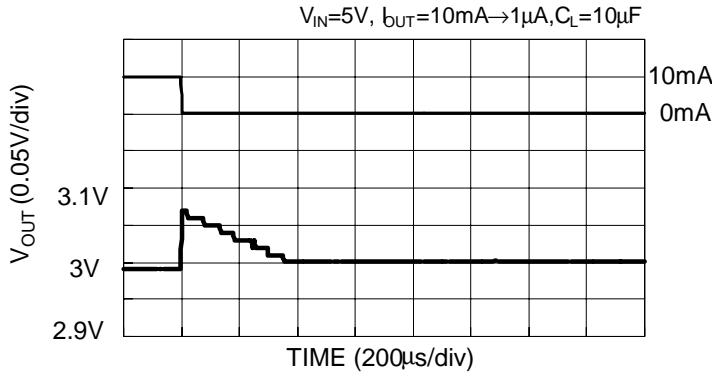

Load dependence of overshoot at load transient

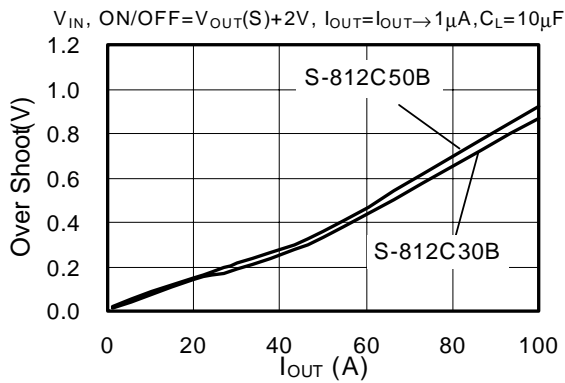

$C_L$  dependence of overshoot at load transient

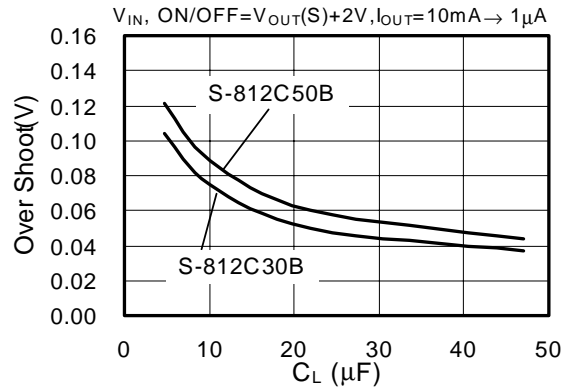

$V_{DD}$  dependence of overshoot at load transient

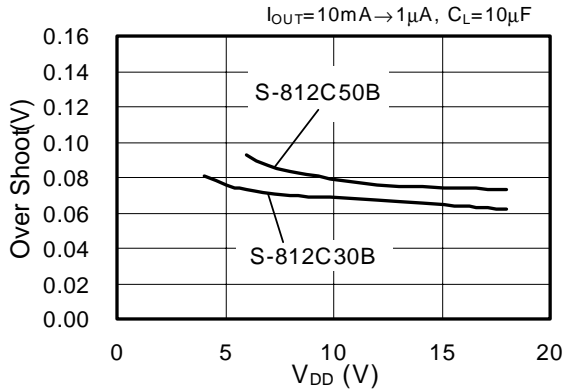

Temperature dependence of overshoot at load transient

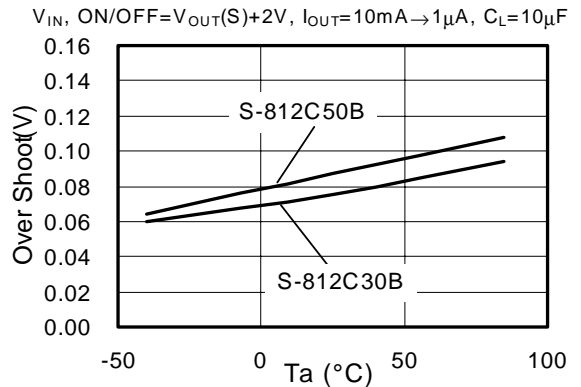

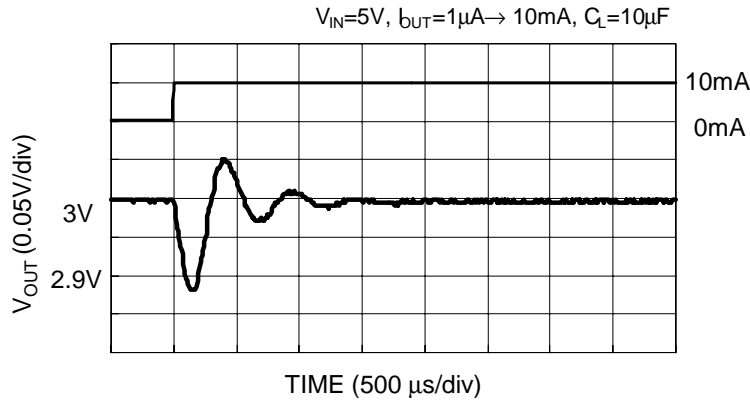

Load dependence of undershoot at load transient

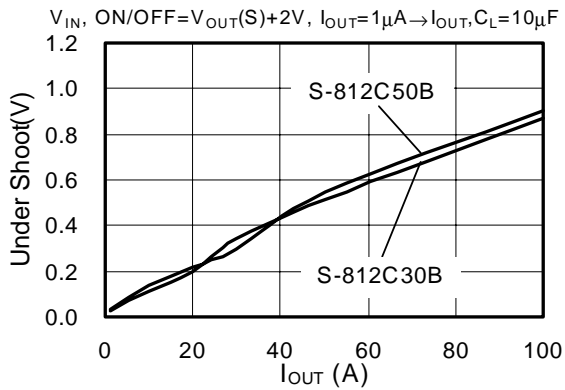

$C_L$  dependence of undershoot at load transient

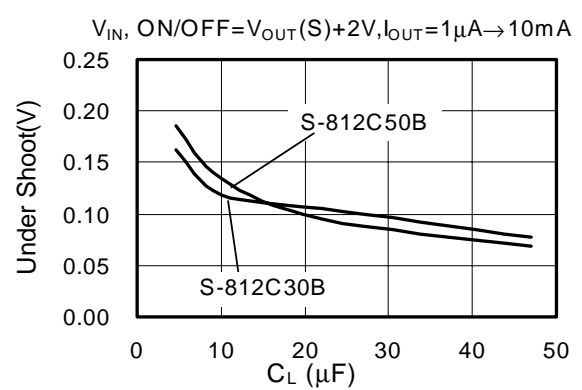

$V_{DD}$  dependence of undershoot at load transient

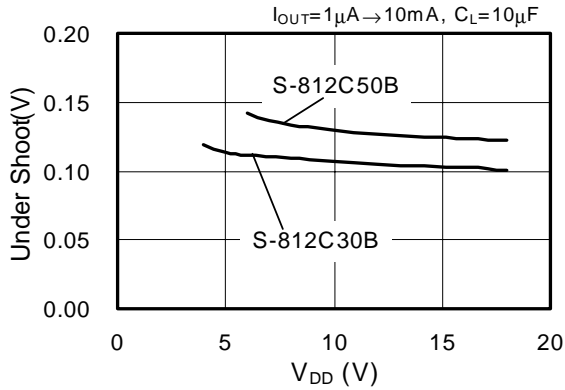

Temperature dependence of undershoot at load transient

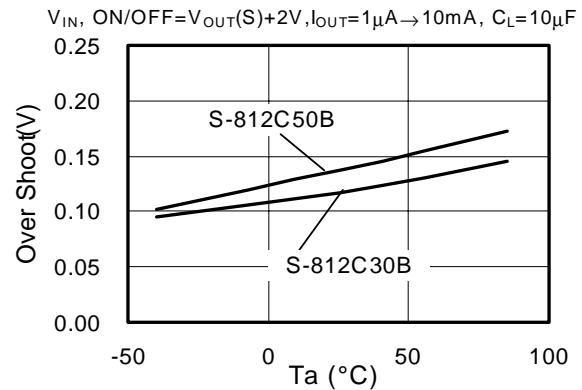

# SOT-23-5

MP005-A

010801

## ● Dimensions

Unit : mm

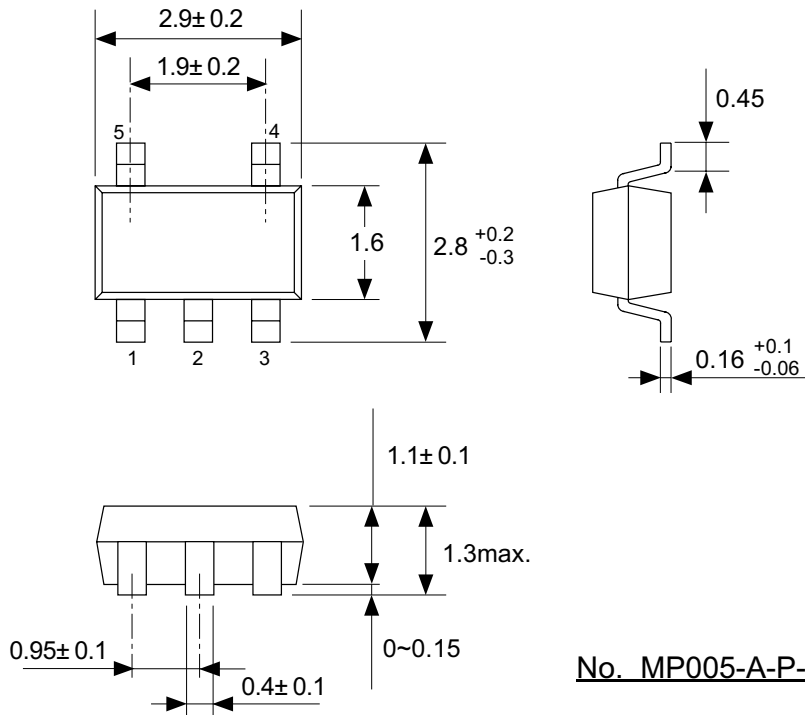

No. MP005-A-P-SD-1.1

## ● Tape Specifications

## ● Reel Specifications

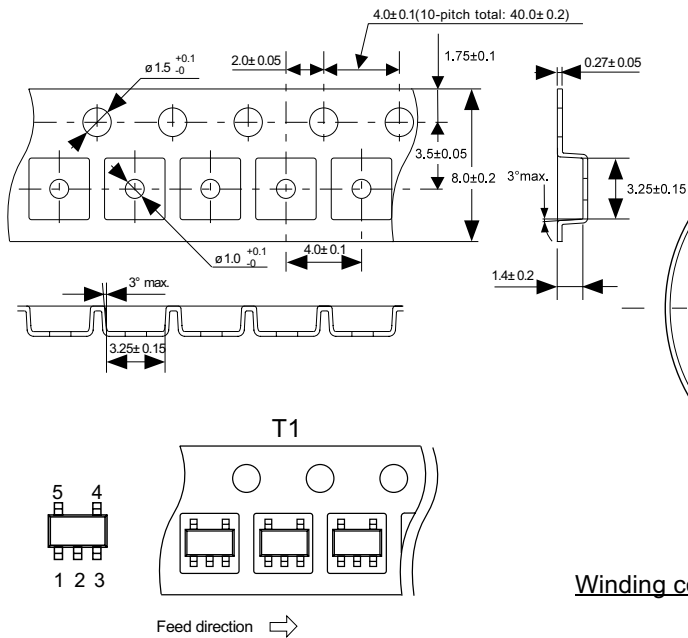

No. MP005-A-C-SD-1.0

3000 pcs./reel

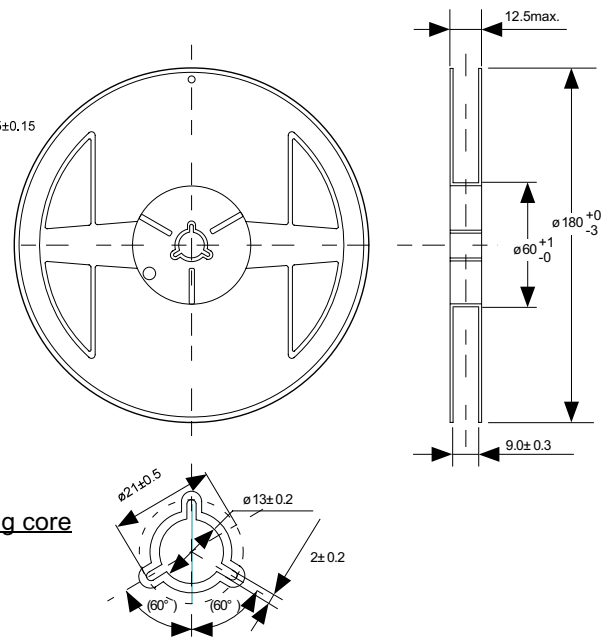

No. MP005-A-R-SD-1.0



●Dimensions

Unit:mm

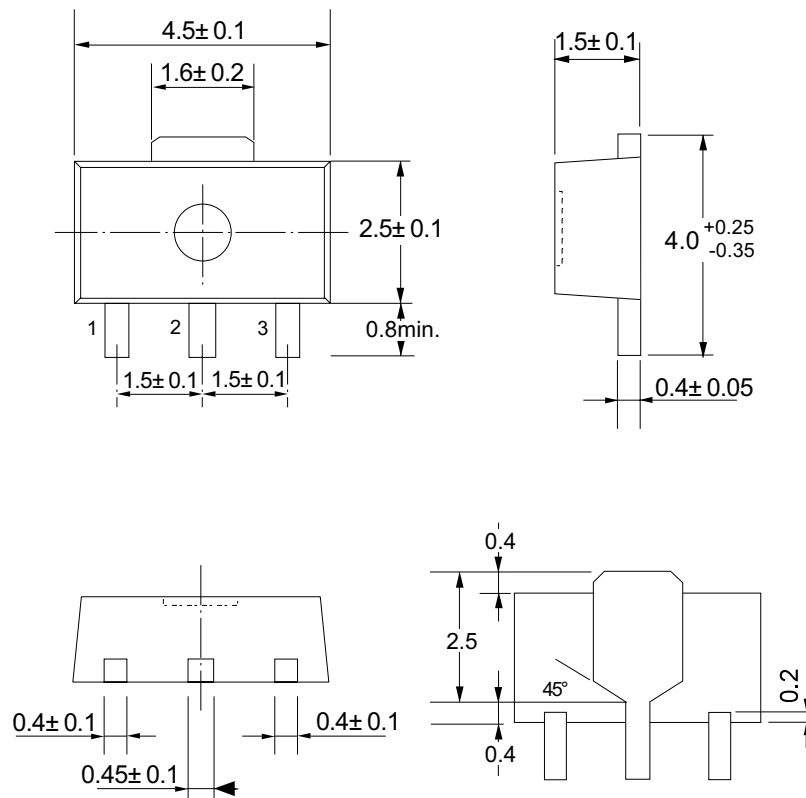

No. UP003-A-P-SD-1.0

●Taping Specifications

●Reel Specifications

1 reel holds 1000 ICs.

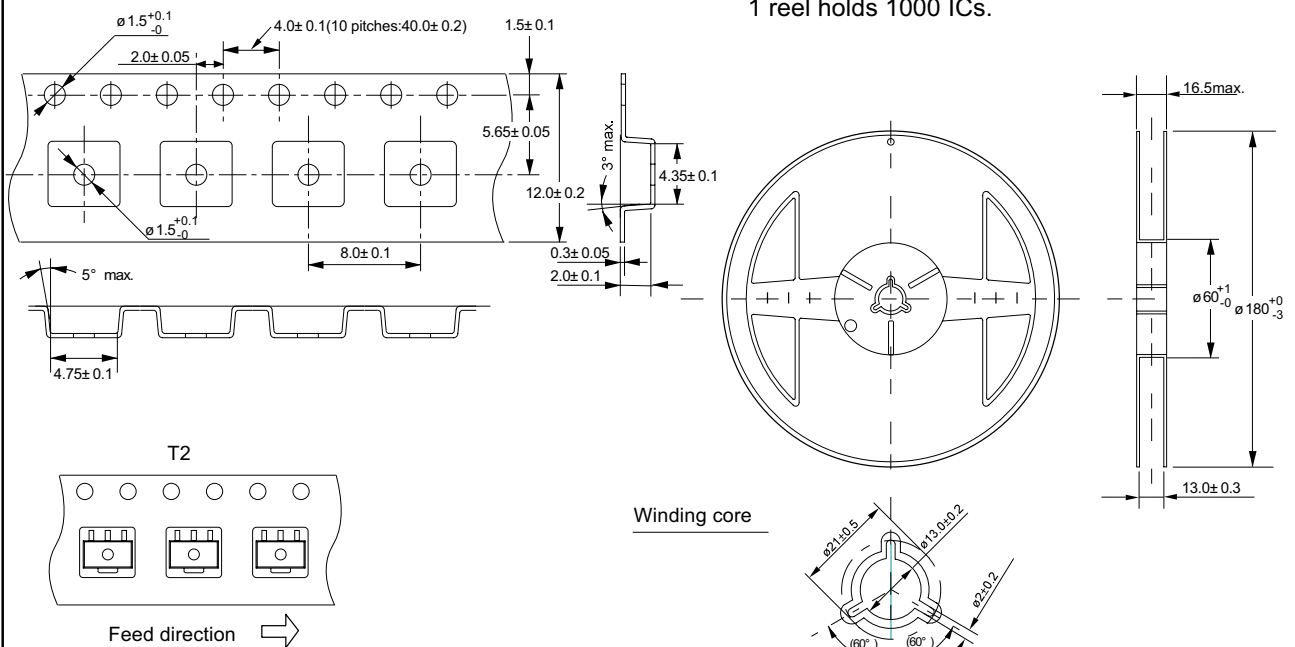

No. UP003-A-C-SD-1.0

No. UP003-A-R-SD-1.0



■ TO-92

YF003-A 010515

● Dimensions

Unit:mm

(1) Bulk

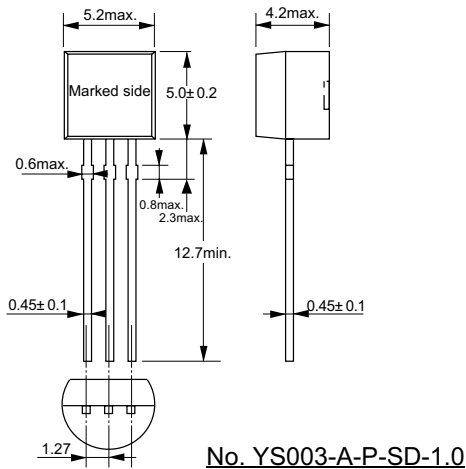

(2) Leadforming for tape (reel/zigzag)

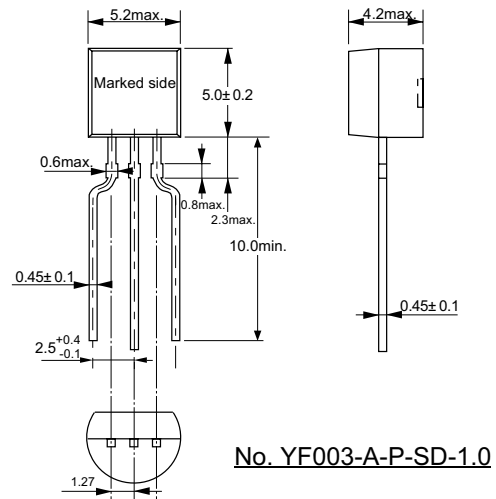

● Tape

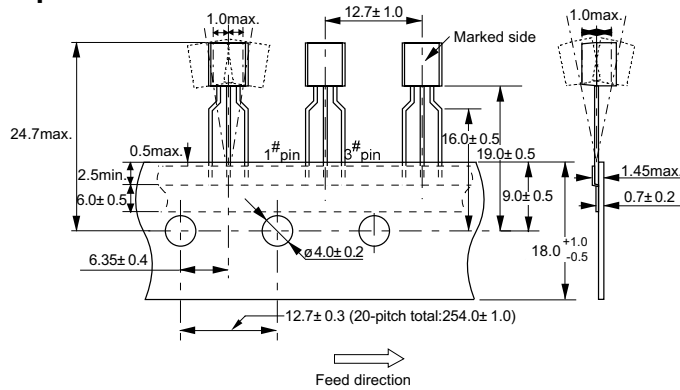

● Zigzag

[Type Z]

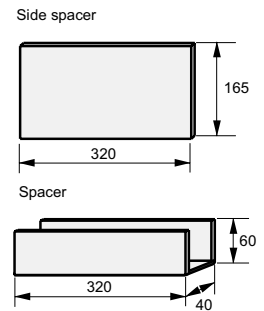

[Type F]

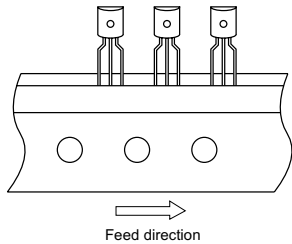

[Type T]

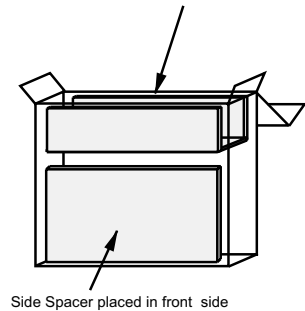
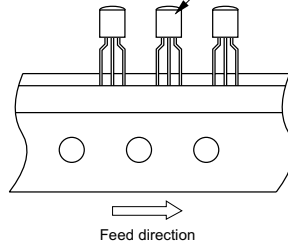

● Reel

1 reel holds 2000 ICs.

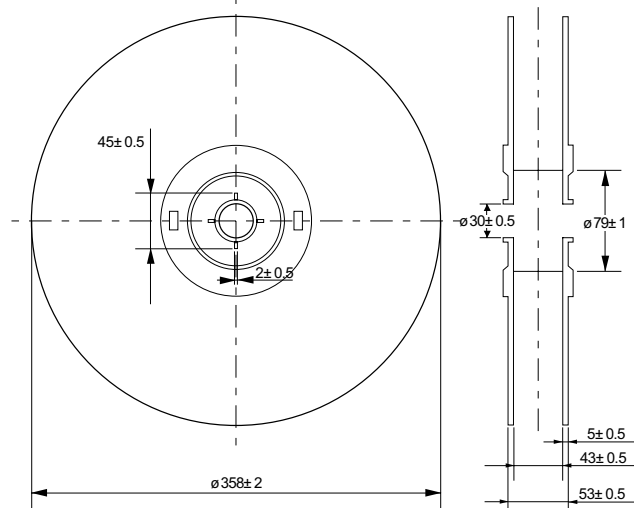

Space more than 4 strokes

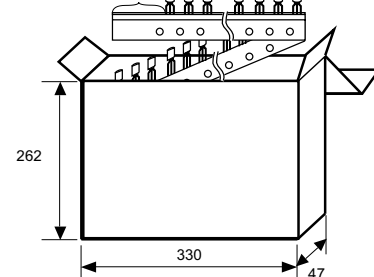

1 box holds 2500 ICs.

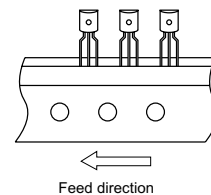

No. YF003-A-R-SD-1.0

No. YF003-A-Z-SD-1.0

- The information described herein is subject to change without notice.
- Seiko Instruments Inc. is not responsible for any problems caused by circuits or diagrams described herein whose related industrial properties, patents, or other rights belong to third parties. The application circuit examples explain typical applications of the products, and do not guarantee the success of any specific mass-production design.
- When the products described herein are regulated products subject to the Wassenaar Arrangement or other agreements, they may not be exported without authorization from the appropriate governmental authority.
- Use of the information described herein for other purposes and/or reproduction or copying without the express permission of Seiko Instruments Inc. is strictly prohibited.
- The products described herein cannot be used as part of any device or equipment affecting the human body, such as exercise equipment, medical equipment, security systems, gas equipment, or any apparatus installed in airplanes and other vehicles, without prior written permission of Seiko Instruments Inc.
- Although Seiko Instruments Inc. exerts the greatest possible effort to ensure high quality and reliability, the failure or malfunction of semiconductor products may occur. The user of these products should therefore give thorough consideration to safety design, including redundancy, fire-prevention measures, and malfunction prevention, to prevent any accidents, fires, or community damage that may ensue.