

## Contents

Features .....	1
Applications .....	1
Pin Assignment.....	1
Block Diagram.....	1
Selection Guide.....	2
Absolute Maximum Ratings .....	2
Electrical Characteristics.....	3
Test Circuits.....	11
Technical Terms .....	11
Operation .....	12
Transient Response.....	13
Standard Circuit .....	16
Application Circuits .....	16
Notes on Design .....	18
Dimensions.....	19
Markings .....	19
Package Power Dissipation.....	20
Taping Dimensions .....	21
Characteristics .....	24
Measuring Circuits .....	30

# HIGH-PRECISION VOLTAGE REGULATOR

# S-812XXSG Series

The S-812XXSG Series is a three-terminal positive voltage regulator made using the CMOS process. Since the S-812XXSG Series has higher precision output voltage and consumes less current than existing three-terminal voltage regulators, battery-powered portable equipment can have a higher performance and a longer service life.

### ■ Features

- Low power consumption (2.5  $\mu$ A max.)
- High accuracy of output voltage  
 $\pm 2\%$  :  $V_{OUT} \geq 2.7$  V  
 $\pm 2.4\%$  :  $V_{OUT} \leq 2.6$  V
- Small input/output voltage difference  
(S-81250SG: 160 mV typ.  $I_{OUT} = 10$  mA)
- Low temperature coefficient of output voltage  
(S-81250SG:  $\pm 0.625$  mV/  $^{\circ}$ C typ.)
- Wide operating voltage range  
(S-81250SG: 16 V max.)
- Good line regulation  
(S-81250SG: 40 mV typ.  $I_{OUT} = 1\mu$ A to 40 mA)
- TO-92, SOT-89-3 and SOT-23-5 package

### ■ Block Diagram

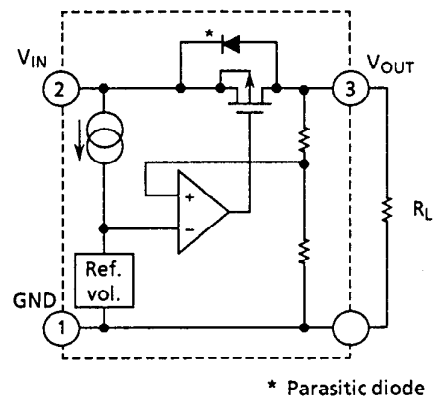

Figure 1

### ■ Applications

- Constant voltage power supply of battery-powered equipment, communications equipment, video equipment and others

### ■ Pin Assignment

(1) TO-92

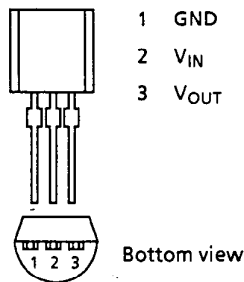

(2) SOT-89-3

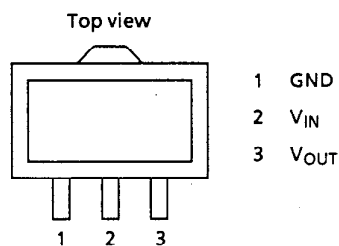

(3) SOT-23-5

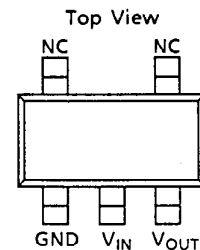

Figure 2

# HIGH-PRECISION VOLTAGE REGULATOR

## S-812XXSG Series

### ■ Selection Guide

Table 1

Output voltage	TO-92*1	SOT-89-3*2	SOT-23-5*2
1.1 V ± 2.4%	S-81211SGY-X	S-81211SGUP-DQA-X	S-81211SG-QA-X
1.5 V ± 2.4%	S-81215SGY-X	S-81215SGUP-DQK-X	S-81215SG-QK-X
1.7 V ± 2.4%			S-812175G-QQ-X
1.8 V ± 2.4%			S-812185G-QR-X
2.0 V ± 2.4%	S-81220SGY-X	S-81220SGUP-DQS-X	S-81220SG-QS-X
2.1 V ± 2.4%		S-812215GUP-DQU-X	
2.3 V ± 2.4%	S-81223SGY-X		S-812235G-QW-X
2.4 V ± 2.4%	S-81224SGY-X	S-812245GUP-DQX-X	S-812245G-QX-X
2.5 V ± 2.4%	S-81225SGY-X	S-812255GUP-DQH-X	S-812255G-QH-X
2.7 V ± 2.0%		S-812275GUP-DQZ-X	
3.0 V ± 2.0%	S-81230SGY-X	S-812305GUP-DQB-X	S-812305G-QB-X
3.3 V ± 2.0%	S-81233SGY-X	S-812335GUP-DQF-X	S-812335G-QF-X
3.5 V ± 2.0%	S-81235SGY-X	S-812355GUP-DQI-X	S-812355G-QI-X
3.7 V ± 2.0%	S-812375GY-X	S-812375GUP-DQE-X	S-812375G-QE-X
4.0 V ± 2.0%	S-81240SGY-X	S-812405GUP-DQJ-X	S-812405G-QJ-X
4.5 V ± 2.0%	S-81245SGY-X	S-812455GUP-DQ5-X	S-812455G-Q5-X
4.6 V ± 2.0%	S-81246SGY-X	S-812465GUP-DQM-X	S-812465G-QM-X
4.7 V ± 2.0%			S-812475G-IE-X
5.0 V ± 2.0%	S-81250SGY-X	S-812505GUP-DQD-X	S-812505G-QD-X
5.2 V ± 2.0%	S-81252SGY-X	S-812525GUP-DQL-X	S-812525G-QL-X
5.3 V ± 2.0%		S-812535GUP-DIJ-X	
5.4 V ± 2.0%		S-812545GUP-DIK-X	
5.5 V ± 2.0%		S-812555GUP-DIL-X	
5.6 V ± 2.0%		S-812565GUP-DIM-X	

\*1 In the TO-92 package, "X" differs depending upon the packaging form:

B : Loose

T, Z : Tape

\*2 In the SOT package, "X" differs depending upon the packaging form (in the SOT-23-5 package, on-tape packed products only):

S : Stick

T : Tape (T1 and T2 are available depending upon the direction of the IC)

### ■ Absolute Maximum Ratings

Table 2

(Unless otherwise specified: Ta = 25°C)

Parameter	Symbol	Conditions	Ratings	Unit
Input voltage	V <sub>IN</sub>	V <sub>OUT</sub> ≤ 2.6 V	12	V
		V <sub>OUT</sub> ≥ 2.7 V	18	
Output voltage	V <sub>OUT</sub>		V <sub>IN</sub> + 0.3 to V <sub>SS</sub> - 0.3	V
Output current	I <sub>OUT</sub>		100	mA
Power dissipation	P <sub>D</sub>	TO-92	400	mW
		SOT-89-3	500	
		SOT-23-5	150	
Operating temperature	T <sub>opr</sub>		-40 to +85	°C
Storage temperature	T <sub>stg</sub>		-40 to +125	°C

Caution: Keep static electricity to a minimum.

■ **Electrical Characteristics**

1. S-81211SGY-X, S-81211SGUP-DQA-X, S-81211SG-QA-X (1.1-V output type)

**Table 3**

(Unless otherwise specified: Ta = 25°C)

Parameter	Symbol	Conditions	Min.	Typ.	Max.	Unit	Test cir.
Output voltage	V <sub>OUT</sub>	V <sub>IN</sub> = 1.5 V, I <sub>OUT</sub> = 0.5 mA	1.073	1.100	1.127	V	1
I/O voltage difference	V <sub>dif</sub>	I <sub>OUT</sub> = 0.5 mA	—	0.05	0.2	V	1
Line regulation 1	ΔV <sub>OUT1</sub>	V <sub>IN</sub> = 1.5 to 10 V I <sub>OUT</sub> = 0.5 mA	—	10	50	mV	1
Line regulation 2	ΔV <sub>OUT2</sub>	V <sub>IN</sub> = 1.5 to 10 V I <sub>OUT</sub> = 10 μA	—	10	77	mV	1
Load regulation	ΔV <sub>OUT3</sub>	V <sub>IN</sub> = 1.5 V I <sub>OUT</sub> = 10 μA to 0.5 mA	—	10	100	mV	1
Current consumption	I <sub>SS</sub>	V <sub>IN</sub> = 1.5 V, Unloaded	—	1.2	2.5	μA	2
Input voltage	V <sub>IN</sub>		—	—	10	V	—
Temperature characteristic of ΔV <sub>OUT</sub>	$\frac{\Delta V_{OUT}}{\Delta T_a}$	V <sub>IN</sub> = 1.5 V, I <sub>OUT</sub> = 0.5 mA Ta = -40°C to 85°C	—	± 0.138	—	mV/°C	—

2. S-81215SGY-X, S-81215SGUP-DQK-X, S-81215SG-QK-X (1.5-V output type)

**Table 4**

(Unless otherwise specified: Ta = 25°C)

Parameter	Symbol	Conditions	Min.	Typ.	Max.	Unit	Test cir.
Output voltage	V <sub>OUT</sub>	V <sub>IN</sub> = 3.5 V, I <sub>OUT</sub> = 0.5 mA	1.464	1.500	1.536	V	1
I/O voltage difference	V <sub>dif</sub>	I <sub>OUT</sub> = 0.5 mA	—	0.03	0.18	V	1
Line regulation 1	ΔV <sub>OUT1</sub>	V <sub>IN</sub> = 2.5 to 10 V I <sub>OUT</sub> = 0.5 mA	—	7	39	mV	1
Line regulation 2	ΔV <sub>OUT2</sub>	V <sub>IN</sub> = 2.5 to 10 V I <sub>OUT</sub> = 1 μA	—	7	105	mV	1
Load regulation	ΔV <sub>OUT3</sub>	V <sub>IN</sub> = 3.5 V I <sub>OUT</sub> = 1 μA to 10 mA	—	80	120	mV	1
Current consumption	I <sub>SS</sub>	V <sub>IN</sub> = 3.5 V, Unloaded	—	1.2	2.5	μA	2
Input voltage	V <sub>IN</sub>		—	—	10	V	—
Temperature characteristic of ΔV <sub>OUT</sub>	$\frac{\Delta V_{OUT}}{\Delta T_a}$	V <sub>IN</sub> = 3.5 V, I <sub>OUT</sub> = 0.5 mA Ta = -40°C to 85°C	—	± 0.188	—	mV/°C	—

3. S-81217SG-QQ-X (1.7-V output type)

**Table 5**

(Unless otherwise specified: Ta = 25°C)

Parameter	Symbol	Conditions	Min.	Typ.	Max.	Unit	Test cir.
Output voltage	V <sub>OUT</sub>	V <sub>IN</sub> = 3.7 V, I <sub>OUT</sub> = 10 mA	1.659	1.700	1.741	V	1
I/O voltage difference	V <sub>dif</sub>	I <sub>OUT</sub> = 10 mA	—	0.77	1.63	V	1
Line regulation 1	ΔV <sub>OUT1</sub>	V <sub>IN</sub> = 2.7 to 10 V I <sub>OUT</sub> = 1 mA	—	8	43	mV	1
Line regulation 2	ΔV <sub>OUT2</sub>	V <sub>IN</sub> = 2.7 to 10 V I <sub>OUT</sub> = 1 μA	—	8	119	mV	1
Load regulation	ΔV <sub>OUT3</sub>	V <sub>IN</sub> = 3.7 V I <sub>OUT</sub> = 1 μA to 10 mA	—	80	120	mV	1
Current consumption	I <sub>SS</sub>	V <sub>IN</sub> = 3.7 V, Unloaded	—	1.2	2.5	μA	2
Input voltage	V <sub>IN</sub>		—	—	10	V	—
Temperature characteristic of ΔV <sub>OUT</sub>	$\frac{\Delta V_{OUT}}{\Delta T_a}$	V <sub>IN</sub> = 3.7 V, I <sub>OUT</sub> = 10 mA Ta = -40°C to 85°C	—	± 0.213	—	mV/°C	—

# HIGH-PRECISION VOLTAGE REGULATOR

## S-812XXSG Series

### 4. S-81218SG-QR-X (1.8-V output type)

Table 6

(Unless otherwise specified: Ta = 25°C)

Parameter	Symbol	Conditions	Min.	Typ.	Max.	Unit	Test cir.
Output voltage	V <sub>OUT</sub>	V <sub>IN</sub> = 3.8 V, I <sub>OUT</sub> = 10 mA	1.756	1.800	1.843	V	1
I/O voltage difference	V <sub>dif</sub>	I <sub>OUT</sub> = 10 mA	—	0.72	1.55	V	1
Line regulation 1	ΔV <sub>OUT1</sub>	V <sub>IN</sub> = 2.8 to 10 V I <sub>OUT</sub> = 1 mA	—	8	45	mV	1
Line regulation 2	ΔV <sub>OUT2</sub>	V <sub>IN</sub> = 2.8 to 10 V I <sub>OUT</sub> = 1 μA	—	8	126	mV	1
Load regulation	ΔV <sub>OUT3</sub>	V <sub>IN</sub> = 3.8 V I <sub>OUT</sub> = 1 μA to 10 mA	—	80	120	mV	1
Current consumption	I <sub>SS</sub>	V <sub>IN</sub> = 3.8 V, Unloaded	—	1.2	2.5	μA	2
Input voltage	V <sub>IN</sub>		—	—	10	V	—
Temperature characteristic of ΔV <sub>OUT</sub>	$\frac{\Delta V_{OUT}}{\Delta T_a}$	V <sub>IN</sub> = 3.8 V, I <sub>OUT</sub> = 10 mA Ta = -40°C to 85°C	—	± 0.225	—	mV/°C	—

### 5. S-81220SGY-X, S-81220SGUP-DQS-X, S-81220SG-QS-X (2.0-V output type)

Table 7

(Unless otherwise specified: Ta = 25°C)

Parameter	Symbol	Conditions	Min.	Typ.	Max.	Unit	Test cir.
Output voltage	V <sub>OUT</sub>	V <sub>IN</sub> = 4.0 V, I <sub>OUT</sub> = 10 mA	1.592	2.000	2.048	V	1
I/O voltage difference	V <sub>dif</sub>	I <sub>OUT</sub> = 10 mA	—	0.63	1.39	V	1
Line regulation 1	ΔV <sub>OUT1</sub>	V <sub>IN</sub> = 3.0 to 10 V I <sub>OUT</sub> = 1 mA	—	8	48	mV	1
Line regulation 2	ΔV <sub>OUT2</sub>	V <sub>IN</sub> = 3.0 to 10 V I <sub>OUT</sub> = 1 μA	—	8	140	mV	1
Load regulation	ΔV <sub>OUT3</sub>	V <sub>IN</sub> = 4.0 V I <sub>OUT</sub> = 1 μA to 10 mA	—	80	120	mV	1
Current consumption	I <sub>SS</sub>	V <sub>IN</sub> = 4.0 V, Unloaded	—	1.2	2.5	μA	2
Input voltage	V <sub>IN</sub>		—	—	10	V	—
Temperature characteristic of ΔV <sub>OUT</sub>	$\frac{\Delta V_{OUT}}{\Delta T_a}$	V <sub>IN</sub> = 4.0 V, I <sub>OUT</sub> = 10 mA Ta = -40°C to 85°C	—	± 0.250	—	mV/°C	—

### 6. S-81221SGUP-DQU-X (2.1-V output type)

Table 8

(Unless otherwise specified: Ta = 25°C)

Parameter	Symbol	Conditions	Min.	Typ.	Max.	Unit	Test cir.
Output voltage	V <sub>OUT</sub>	V <sub>IN</sub> = 4.1 V, I <sub>OUT</sub> = 10 mA	2.049	2.100	2.151	V	1
I/O voltage difference	V <sub>dif</sub>	I <sub>OUT</sub> = 10 mA	—	0.59	1.32	V	1
Line regulation 1	ΔV <sub>OUT1</sub>	V <sub>IN</sub> = 3.1 to 10 V I <sub>OUT</sub> = 1 mA	—	9	50	mV	1
Line regulation 2	ΔV <sub>OUT2</sub>	V <sub>IN</sub> = 3.1 to 10 V I <sub>OUT</sub> = 1 μA	—	9	147	mV	1
Load regulation	ΔV <sub>OUT3</sub>	V <sub>IN</sub> = 4.1 V I <sub>OUT</sub> = 1 μA to 10 mA	—	80	120	mV	1
Current consumption	I <sub>SS</sub>	V <sub>IN</sub> = 4.1 V, Unloaded	—	1.2	2.5	μA	2
Input voltage	V <sub>IN</sub>		—	—	10	V	—
Temperature characteristic of ΔV <sub>OUT</sub>	$\frac{\Delta V_{OUT}}{\Delta T_a}$	V <sub>IN</sub> = 4.1 V, I <sub>OUT</sub> = 10 mA Ta = -40°C to 85°C	—	± 0.263	—	mV/°C	—

7. S-81223SGY-X, S-81223SG-QW-X (2.3-V output type)

**Table 9**

(Unless otherwise specified: Ta = 25°C)

Parameter	Symbol	Conditions	Min.	Typ.	Max.	Unit	Test cir.
Output voltage	V <sub>OUT</sub>	V <sub>IN</sub> = 4.3 V, I <sub>OUT</sub> = 10 mA	2.244	2.300	2.356	V	1
I/O voltage difference	V <sub>dif</sub>	I <sub>OUT</sub> = 10 mA	—	0.53	1.20	V	1
Line regulation 1	ΔV <sub>OUT1</sub>	V <sub>IN</sub> = 3.3 to 10 V I <sub>OUT</sub> = 1 mA	—	9	54	mV	1
Line regulation 2	ΔV <sub>OUT2</sub>	V <sub>IN</sub> = 3.3 to 10 V I <sub>OUT</sub> = 1 μA	—	9	161	mV	1
Load regulation	ΔV <sub>OUT3</sub>	V <sub>IN</sub> = 4.3 V I <sub>OUT</sub> = 1 μA to 10 mA	—	80	120	mV	1
Current consumption	I <sub>SS</sub>	V <sub>IN</sub> = 4.3 V, Unloaded	—	1.2	2.5	μA	2
Input voltage	V <sub>IN</sub>		—	—	10	V	—
Temperature characteristic of ΔV <sub>OUT</sub>	$\frac{\Delta V_{OUT}}{\Delta T_a}$	V <sub>IN</sub> = 4.3 V, I <sub>OUT</sub> = 10 mA Ta = -40°C to 85°C	—	± 0.288	—	mV/°C	—

8. S-81224SGY-X, S-81224SGUP-DQX-X, S-81224SG-QX-X (2.4-V output type)

**Table 10**

(Unless otherwise specified: Ta = 25°C)

Parameter	Symbol	Conditions	Min.	Typ.	Max.	Unit	Test cir.
Output voltage	V <sub>OUT</sub>	V <sub>IN</sub> = 4.4 V, I <sub>OUT</sub> = 10 mA	2.342	2.400	2.458	V	1
I/O voltage difference	V <sub>dif</sub>	I <sub>OUT</sub> = 10 mA	—	0.49	1.15	V	1
Line regulation 1	ΔV <sub>OUT1</sub>	V <sub>IN</sub> = 3.4 to 10 V I <sub>OUT</sub> = 1 mA	—	10	55	mV	1
Line regulation 2	ΔV <sub>OUT2</sub>	V <sub>IN</sub> = 3.4 to 10 V I <sub>OUT</sub> = 1 μA	—	10	168	mV	1
Load regulation	ΔV <sub>OUT3</sub>	V <sub>IN</sub> = 4.4 V I <sub>OUT</sub> = 1 μA to 10 mA	—	80	120	mV	1
Current consumption	I <sub>SS</sub>	V <sub>IN</sub> = 4.4 V, Unloaded	—	1.2	2.5	μA	2
Input voltage	V <sub>IN</sub>		—	—	10	V	—
Temperature characteristic of ΔV <sub>OUT</sub>	$\frac{\Delta V_{OUT}}{\Delta T_a}$	V <sub>IN</sub> = 4.4 V, I <sub>OUT</sub> = 10 mA Ta = -40°C to 85°C	—	± 0.300	—	mV/°C	—

9. S-81225SGY-X, S-81225SGUP-DQH-X, S-81225SG-QH-X (2.5-V output type)

**Table 11**

(Unless otherwise specified: Ta = 25°C)

Parameter	Symbol	Conditions	Min.	Typ.	Max.	Unit	Test cir.
Output voltage	V <sub>OUT</sub>	V <sub>IN</sub> = 4.5 V, I <sub>OUT</sub> = 10 mA	2.440	2.500	2.560	V	1
I/O voltage difference	V <sub>dif</sub>	I <sub>OUT</sub> = 10 mA	—	0.59	1.32	V	1
Line regulation 1	ΔV <sub>OUT1</sub>	V <sub>IN</sub> = 3.5 to 10 V I <sub>OUT</sub> = 1 mA	—	10	57	mV	1
Line regulation 2	ΔV <sub>OUT2</sub>	V <sub>IN</sub> = 3.5 to 10 V I <sub>OUT</sub> = 1 μA	—	10	175	mV	1
Load regulation	ΔV <sub>OUT3</sub>	V <sub>IN</sub> = 4.5 V I <sub>OUT</sub> = 1 μA to 10 mA	—	80	120	mV	1
Current consumption	I <sub>SS</sub>	V <sub>IN</sub> = 4.5 V, Unloaded	—	1.2	2.5	μA	2
Input voltage	V <sub>IN</sub>		—	—	10	V	—
Temperature characteristic of ΔV <sub>OUT</sub>	$\frac{\Delta V_{OUT}}{\Delta T_a}$	V <sub>IN</sub> = 4.5 V, I <sub>OUT</sub> = 10 mA Ta = -40°C to 85°C	—	± 0.313	—	mV/°C	—

# HIGH-PRECISION VOLTAGE REGULATOR

## S-812XXSG Series

### 10. S-81227SGUP-DQZ-X (2.7-V output type)

**Table 12**

(Unless otherwise specified: Ta = 25°C)

Parameter	Symbol	Conditions	Min.	Typ.	Max.	Unit	Test cir.
Output voltage	V <sub>OUT</sub>	V <sub>IN</sub> = 4.7 V, I <sub>OUT</sub> = 10 mA	2.646	2.700	2.754	V	1
I/O voltage difference	V <sub>dif</sub>	I <sub>OUT</sub> = 10 mA	—	0.52	1.20	V	1
Line regulation 1	ΔV <sub>OUT1</sub>	V <sub>IN</sub> = 3.7 to 16 V I <sub>OUT</sub> = 1 mA	—	36	72	mV	1
Line regulation 2	ΔV <sub>OUT2</sub>	V <sub>IN</sub> = 3.7 to 16 V I <sub>OUT</sub> = 1 μA	—	36	189	mV	1
Load regulation	ΔV <sub>OUT3</sub>	V <sub>IN</sub> = 4.7 V I <sub>OUT</sub> = 1 μA to 20 mA	—	80	120	mV	1
Current consumption	I <sub>SS</sub>	V <sub>IN</sub> = 4.7 V, Unloaded	—	1.2	2.5	μA	2
Input voltage	V <sub>IN</sub>		—	—	16	V	—
Temperature characteristic of ΔV <sub>OUT</sub>	$\frac{\Delta V_{OUT}}{\Delta T_a}$	V <sub>IN</sub> = 4.7 V, I <sub>OUT</sub> = 10 mA Ta = -40°C to 85°C	—	± 0.338	—	mV/°C	—

### 11. S-81230SGY-X, S-81230SGUP-DQB-X, S-81230SG-QB-X (3.0-V output type)

**Table 13**

(Unless otherwise specified: Ta = 25°C)

Parameter	Symbol	Conditions	Min.	Typ.	Max.	Unit	Test cir.
Output voltage	V <sub>OUT</sub>	V <sub>IN</sub> = 5.0 V, I <sub>OUT</sub> = 10 mA	2.940	3.000	3.060	V	1
I/O voltage difference	V <sub>dif</sub>	I <sub>OUT</sub> = 10 mA	—	0.44	1.04	V	1
Line regulation 1	ΔV <sub>OUT1</sub>	V <sub>IN</sub> = 4.0 to 16 V I <sub>OUT</sub> = 1 mA	—	39	78	mV	1
Line regulation 2	ΔV <sub>OUT2</sub>	V <sub>IN</sub> = 4.0 to 16 V I <sub>OUT</sub> = 1 μA	—	39	210	mV	1
Load regulation	ΔV <sub>OUT3</sub>	V <sub>IN</sub> = 5 V I <sub>OUT</sub> = 1 μA to 20 mA	—	60	100	mV	1
Current consumption	I <sub>SS</sub>	V <sub>IN</sub> = 5.0 V, Unloaded	—	1.2	2.5	μA	2
Input voltage	V <sub>IN</sub>		—	—	16	V	—
Temperature characteristic of ΔV <sub>OUT</sub>	$\frac{\Delta V_{OUT}}{\Delta T_a}$	V <sub>IN</sub> = 5.0 V, I <sub>OUT</sub> = 10 mA Ta = -40°C to 85°C	—	± 0.375	—	mV/°C	—

### 12. S-81233SGY-X, S-81233SGUP-DQF-X, S-81233SG-QF-X (3.3-V output type)

**Table 14**

(Unless otherwise specified: Ta = 25°C)

Parameter	Symbol	Conditions	Min.	Typ.	Max.	Unit	Test cir.
Output voltage	V <sub>OUT</sub>	V <sub>IN</sub> = 5.3 V, I <sub>OUT</sub> = 10 mA	3.234	3.300	3.366	V	1
I/O voltage difference	V <sub>dif</sub>	I <sub>OUT</sub> = 10 mA	—	0.37	0.91	V	1
Line regulation 1	ΔV <sub>OUT1</sub>	V <sub>IN</sub> = 4.3 to 16 V I <sub>OUT</sub> = 1 mA	—	42	84	mV	1
Line regulation 2	ΔV <sub>OUT2</sub>	V <sub>IN</sub> = 4.3 to 16 V I <sub>OUT</sub> = 1 μA	—	42	231	mV	1
Load regulation	ΔV <sub>OUT3</sub>	V <sub>IN</sub> = 5.3 V I <sub>OUT</sub> = 1 μA to 20 mA	—	60	100	mV	1
Current consumption	I <sub>SS</sub>	V <sub>IN</sub> = 5.3 V, Unloaded	—	1.2	2.5	μA	2
Input voltage	V <sub>IN</sub>		—	—	16	V	—
Temperature characteristic of ΔV <sub>OUT</sub>	$\frac{\Delta V_{OUT}}{\Delta T_a}$	V <sub>IN</sub> = 5.3 V, I <sub>OUT</sub> = 10 mA Ta = -40°C to 85°C	—	± 0.413	—	mV/°C	—

13. S-81235SGY-X, S-81235SGUP-DQI-X, S-81235SG-QI-X (3.5-V output type)

**Table 15**

(Unless otherwise specified: Ta = 25°C)

Parameter	Symbol	Conditions	Min.	Typ.	Max.	Unit	Test cir.
Output voltage	V <sub>OUT</sub>	V <sub>IN</sub> = 5.5 V, I <sub>OUT</sub> = 10 mA	3.430	3.500	3.570	V	1
I/O voltage difference	V <sub>dif</sub>	I <sub>OUT</sub> = 10 mA	—	0.34	0.84	V	1
Line regulation 1	ΔV <sub>OUT1</sub>	V <sub>IN</sub> = 4.5 to 16 V I <sub>OUT</sub> = 1 mA	—	44	88	mV	1
Line regulation 2	ΔV <sub>OUT2</sub>	V <sub>IN</sub> = 4.5 to 16 V I <sub>OUT</sub> = 1 μA	—	44	245	mV	1
Load regulation	ΔV <sub>OUT3</sub>	V <sub>IN</sub> = 5.5 V I <sub>OUT</sub> = 1 μA to 30 mA	—	60	100	mV	1
Current consumption	I <sub>SS</sub>	V <sub>IN</sub> = 5.5 V, Unloaded	—	1.2	2.5	μA	2
Input voltage	V <sub>IN</sub>		—	—	16	V	—
Temperature characteristic of ΔV <sub>OUT</sub>	$\frac{\Delta V_{OUT}}{\Delta T_a}$	V <sub>IN</sub> = 5.5 V, I <sub>OUT</sub> = 10 mA Ta = -40°C to 85°C	—	± 0.438	—	mV/°C	—

14. S-81237SGY-X, S-81237SGUP-DQE-X, S-81237SG-QE-X (3.7-V output type)

**Table 16**

(Unless otherwise specified: Ta = 25°C)

Parameter	Symbol	Conditions	Min.	Typ.	Max.	Unit	Test cir.
Output voltage	V <sub>OUT</sub>	V <sub>IN</sub> = 5.7 V, I <sub>OUT</sub> = 10 mA	3.626	3.700	3.774	V	1
I/O voltage difference	V <sub>dif</sub>	I <sub>OUT</sub> = 10 mA	—	0.31	0.78	V	1
Line regulation 1	ΔV <sub>OUT1</sub>	V <sub>IN</sub> = 4.7 to 16 V I <sub>OUT</sub> = 1 mA	—	46	92	mV	1
Line regulation 2	ΔV <sub>OUT2</sub>	V <sub>IN</sub> = 4.7 to 16 V I <sub>OUT</sub> = 1 μA	—	46	259	mV	1
Load regulation	ΔV <sub>OUT3</sub>	V <sub>IN</sub> = 5.7 V I <sub>OUT</sub> = 1 μA to 30 mA	—	60	100	mV	1
Current consumption	I <sub>SS</sub>	V <sub>IN</sub> = 5.7 V, Unloaded	—	1.2	2.5	μA	2
Input voltage	V <sub>IN</sub>		—	—	16	V	—
Temperature characteristic of ΔV <sub>OUT</sub>	$\frac{\Delta V_{OUT}}{\Delta T_a}$	V <sub>IN</sub> = 5.7 V, I <sub>OUT</sub> = 10 mA Ta = -40°C to 85°C	—	± 0.463	—	mV/°C	—

15. S-81240SGY-X, S-81240SGUP-DQJ-X, S-81240SG-QJ-X (4.0-V output type)

**Table 17**

(Unless otherwise specified: Ta = 25°C)

Parameter	Symbol	Conditions	Min.	Typ.	Max.	Unit	Test cir.
Output voltage	V <sub>OUT</sub>	V <sub>IN</sub> = 6.0 V, I <sub>OUT</sub> = 10 mA	3.920	4.000	4.080	V	1
I/O voltage difference	V <sub>dif</sub>	I <sub>OUT</sub> = 10 mA	—	0.27	0.70	V	1
Line regulation 1	ΔV <sub>OUT1</sub>	V <sub>IN</sub> = 5.0 to 16 V I <sub>OUT</sub> = 1 mA	—	48	96	mV	1
Line regulation 2	ΔV <sub>OUT2</sub>	V <sub>IN</sub> = 5.0 to 16 V I <sub>OUT</sub> = 1 μA	—	48	280	mV	1
Load regulation	ΔV <sub>OUT3</sub>	V <sub>IN</sub> = 6.0 V I <sub>OUT</sub> = 1 μA to 30 mA	—	50	90	mV	1
Current consumption	I <sub>SS</sub>	V <sub>IN</sub> = 6.0 V, Unloaded	—	1.2	2.5	μA	2
Input voltage	V <sub>IN</sub>		—	—	16	V	—
Temperature characteristic of ΔV <sub>OUT</sub>	$\frac{\Delta V_{OUT}}{\Delta T_a}$	V <sub>IN</sub> = 6.0 V, I <sub>OUT</sub> = 10 mA Ta = -40°C to 85°C	—	± 0.500	—	mV/°C	—



# HIGH-PRECISION VOLTAGE REGULATOR

## S-812XXSG Series

16. S-81245SGY-X, S-81245SGUP-DQ5-X, S-81245SG-Q5-X (4.5-V output type)

Table 18

(Unless otherwise specified: Ta = 25°C)

Parameter	Symbol	Conditions	Min.	Typ.	Max.	Unit	Test cir.
Output voltage	V <sub>OUT</sub>	V <sub>IN</sub> = 6.5 V, I <sub>OUT</sub> = 10 mA	4.410	4.500	4.590	V	1
I/O voltage difference	V <sub>dif</sub>	I <sub>OUT</sub> = 10 mA	—	0.21	0.58	V	1
Line regulation 1	ΔV <sub>OUT1</sub>	V <sub>IN</sub> = 5.5 to 16 V I <sub>OUT</sub> = 1 mA	—	52	104	mV	1
Line regulation 2	ΔV <sub>OUT2</sub>	V <sub>IN</sub> = 5.5 to 16 V I <sub>OUT</sub> = 1 μA	—	52	315	mV	1
Load regulation	ΔV <sub>OUT3</sub>	V <sub>IN</sub> = 6.5 V I <sub>OUT</sub> = 1 μA to 30 mA	—	50	90	mV	1
Current consumption	I <sub>SS</sub>	V <sub>IN</sub> = 6.5 V, Unloaded	—	1.2	2.5	μA	2
Input voltage	V <sub>IN</sub>		—	—	16	V	—
Temperature characteristic of ΔV <sub>OUT</sub>	$\frac{\Delta V_{OUT}}{\Delta T_a}$	V <sub>IN</sub> = 6.5 V, I <sub>OUT</sub> = 10 mA Ta = -40°C to 5°C	—	± 0.563	—	mV/°C	—

17. S-81246SGY-X, S-81246SGUP-DQM-X, S-81246SG-QM-X (4.6-V output type)

Table 19

(Unless otherwise specified: Ta = 25°C)

Parameter	Symbol	Conditions	Min.	Typ.	Max.	Unit	Test cir.
Output voltage	V <sub>OUT</sub>	V <sub>IN</sub> = 6.6 V, I <sub>OUT</sub> = 10 mA	4.508	4.600	4.692	V	1
I/O voltage difference	V <sub>dif</sub>	I <sub>OUT</sub> = 10 mA	—	0.20	0.57	V	1
Line regulation 1	ΔV <sub>OUT1</sub>	V <sub>IN</sub> = 5.6 to 16 V I <sub>OUT</sub> = 1 mA	—	53	105	mV	1
Line regulation 2	ΔV <sub>OUT2</sub>	V <sub>IN</sub> = 5.6 to 16 V I <sub>OUT</sub> = 1 μA	—	53	322	mV	1
Load regulation	ΔV <sub>OUT3</sub>	V <sub>IN</sub> = 6.6 V I <sub>OUT</sub> = 1 μA to 30 mA	—	50	90	mV	1
Current consumption	I <sub>SS</sub>	V <sub>IN</sub> = 6.6 V, Unloaded	—	1.2	2.5	μA	2
Input voltage	V <sub>IN</sub>		—	—	16	V	—
Temperature characteristic of ΔV <sub>OUT</sub>	$\frac{\Delta V_{OUT}}{\Delta T_a}$	V <sub>IN</sub> = 6.6 V, I <sub>OUT</sub> = 10 mA Ta = -40°C to 85°C	—	± 0.575	—	mV/°C	—

18. S-81247SG-IE-X (4.7-V output type)

Table 20

(Unless otherwise specified: Ta = 25°C)

Parameter	Symbol	Conditions	Min.	Typ.	Max.	Unit	Test cir.
Output voltage	V <sub>OUT</sub>	V <sub>IN</sub> = 6.7 V, I <sub>OUT</sub> = 10 mA	4.606	4.700	4.794	V	1
I/O voltage difference	V <sub>dif</sub>	I <sub>OUT</sub> = 10 mA	—	0.19	0.55	V	1
Line regulation 1	ΔV <sub>OUT1</sub>	V <sub>IN</sub> = 5.7 to 16 V I <sub>OUT</sub> = 1 mA	—	54	107	mV	1
Line regulation 2	ΔV <sub>OUT2</sub>	V <sub>IN</sub> = 5.7 to 16 V I <sub>OUT</sub> = 1 μA	—	54	329	mV	1
Load regulation	ΔV <sub>OUT3</sub>	V <sub>IN</sub> = 6.7 V I <sub>OUT</sub> = 1 μA to 30 mA	—	50	90	mV	1
Current consumption	I <sub>SS</sub>	V <sub>IN</sub> = 6.7 V, Unloaded	—	1.2	2.5	μA	2
Input voltage	V <sub>IN</sub>		—	—	16	V	—
Temperature characteristic of ΔV <sub>OUT</sub>	$\frac{\Delta V_{OUT}}{\Delta T_a}$	V <sub>IN</sub> = 6.7 V, I <sub>OUT</sub> = 10 mA Ta = -40°C to 85°C	—	± 0.588	—	mV/°C	—

19. S-81250SGY-X, S-81250SGUP-DQD-X, S-81250SG-QD-X (5.0-V output type)

**Table 21**

(Unless otherwise specified: Ta = 25°C)

Parameter	Symbol	Conditions	Min.	Typ.	Max.	Unit	Test cir.
Output voltage	V <sub>OUT</sub>	V <sub>IN</sub> = 7.0 V, I <sub>OUT</sub> = 10 mA	4.900	5.000	5.100	V	1
I/O voltage difference	V <sub>dif</sub>	I <sub>OUT</sub> = 10 mA	—	0.16	0.50	V	1
Line regulation 1	ΔV <sub>OUT1</sub>	V <sub>IN</sub> = 6.0 to 16 V I <sub>OUT</sub> = 1 mA	—	55	110	mV	1
Line regulation 2	ΔV <sub>OUT2</sub>	V <sub>IN</sub> = 6.0 to 16 V I <sub>OUT</sub> = 1 μA	—	55	350	mV	1
Load regulation	ΔV <sub>OUT3</sub>	V <sub>IN</sub> = 7.0 V I <sub>OUT</sub> = 1 μA to 40 mA	—	40	80	mV	1
Current consumption	I <sub>SS</sub>	V <sub>IN</sub> = 7.0 V, Unloaded	—	1.2	2.5	μA	2
Input voltage	V <sub>IN</sub>		—	—	16	V	—
Temperature characteristic of ΔV <sub>OUT</sub>	$\frac{\Delta V_{OUT}}{\Delta T_a}$	V <sub>IN</sub> = 7.0 V, I <sub>OUT</sub> = 10 mA Ta = -40°C to 85°C	—	± 0.625	—	mV/°C	—

20. S-81252SGY-X, S-81252SGUP-DQL-X, S-81252SG-QL-X (5.2-V output type)

**Table 22**

(Unless otherwise specified: Ta = 25°C)

Parameter	Symbol	Conditions	Min.	Typ.	Max.	Unit	Test cir.
Output voltage	V <sub>OUT</sub>	V <sub>IN</sub> = 7.2 V, I <sub>OUT</sub> = 10 mA	5.096	5.200	5.304	V	1
I/O voltage difference	V <sub>dif</sub>	I <sub>OUT</sub> = 10 mA	—	0.15	0.47	V	1
Line regulation 1	ΔV <sub>OUT1</sub>	V <sub>IN</sub> = 6.2 to 16 V I <sub>OUT</sub> = 1 mA	—	57	113	mV	1
Line regulation 2	ΔV <sub>OUT2</sub>	V <sub>IN</sub> = 6.2 to 16 V I <sub>OUT</sub> = 1 μA	—	57	364	mV	1
Load regulation	ΔV <sub>OUT3</sub>	V <sub>IN</sub> = 7.2 V I <sub>OUT</sub> = 1 μA to 40 mA	—	40	80	mV	1
Current consumption	I <sub>SS</sub>	V <sub>IN</sub> = 7.2 V, Unloaded	—	1.2	2.5	μA	2
Input voltage	V <sub>IN</sub>		—	—	16	V	—
Temperature characteristic of ΔV <sub>OUT</sub>	$\frac{\Delta V_{OUT}}{\Delta T_a}$	V <sub>IN</sub> = 7.2 V, I <sub>OUT</sub> = 10 mA Ta = -40°C to 85°C	—	± 0.650	—	mV/°C	—

21. S-81253SGUP-DIJ-X (5.3-V output type)

**Table 23**

(Unless otherwise specified: Ta = 25°C)

Parameter	Symbol	Conditions	Min.	Typ.	Max.	Unit	Test cir.
Output voltage	V <sub>OUT</sub>	V <sub>IN</sub> = 7.3 V, I <sub>OUT</sub> = 10 mA	5.194	5.300	5.406	V	1
I/O voltage difference	V <sub>dif</sub>	I <sub>OUT</sub> = 10 mA	—	0.14	0.45	V	1
Line regulation 1	ΔV <sub>OUT1</sub>	V <sub>IN</sub> = 6.3 to 16 V I <sub>OUT</sub> = 1 mA	—	57	114	mV	1
Line regulation 2	ΔV <sub>OUT2</sub>	V <sub>IN</sub> = 6.3 to 16 V I <sub>OUT</sub> = 1 μA	—	57	371	mV	1
Load regulation	ΔV <sub>OUT3</sub>	V <sub>IN</sub> = 7.3 V I <sub>OUT</sub> = 1 μA to 40 mA	—	40	80	mV	1
Current consumption	I <sub>SS</sub>	V <sub>IN</sub> = 7.3 V, Unloaded	—	1.2	2.5	μA	2
Input voltage	V <sub>IN</sub>		—	—	16	V	—
Temperature characteristic of ΔV <sub>OUT</sub>	$\frac{\Delta V_{OUT}}{\Delta T_a}$	V <sub>IN</sub> = 7.3 V, I <sub>OUT</sub> = 10 mA Ta = -40°C to 85°C	—	± 0.663	—	mV/°C	—

# HIGH-PRECISION VOLTAGE REGULATOR

## S-812XXSG Series

### 22. S-81254SGUP-DIK-X (5.4-V output type)

Table 24

(Unless otherwise specified: Ta = 25°C)

Parameter	Symbol	Conditions	Min.	Typ.	Max.	Unit	Test cir.
Output voltage	V <sub>OUT</sub>	V <sub>IN</sub> = 7.4 V, I <sub>OUT</sub> = 10 mA	5.292	5.400	5.508	V	1
I/O voltage difference	V <sub>dif</sub>	I <sub>OUT</sub> = 10 mA	—	0.13	0.44	V	1
Line regulation 1	ΔV <sub>OUT1</sub>	V <sub>IN</sub> = 6.4 to 16 V I <sub>OUT</sub> = 1 mA	—	58	115	mV	1
Line regulation 2	ΔV <sub>OUT2</sub>	V <sub>IN</sub> = 6.4 to 16 V I <sub>OUT</sub> = 1 μA	—	58	378	mV	1
Load regulation	ΔV <sub>OUT3</sub>	V <sub>IN</sub> = 7.4 V I <sub>OUT</sub> = 1 μA to 40 mA	—	40	80	mV	1
Current consumption	I <sub>SS</sub>	V <sub>IN</sub> = 7.4 V, Unloaded	—	1.2	2.5	μA	2
Input voltage	V <sub>IN</sub>		—	—	16	V	—
Temperature characteristic of ΔV <sub>OUT</sub>	$\frac{\Delta V_{OUT}}{\Delta T_a}$	V <sub>IN</sub> = 7.4 V, I <sub>OUT</sub> = 10 mA Ta = -40°C to 85°C	—	± 0.675	—	mV/°C	—

### 23. S-81255SGUP-DIL-X (5.5-V output type)

Table 25

(Unless otherwise specified: Ta = 25°C)

Parameter	Symbol	Conditions	Min.	Typ.	Max.	Unit	Test cir.
Output voltage	V <sub>OUT</sub>	V <sub>IN</sub> = 7.5 V, I <sub>OUT</sub> = 10 mA	5.390	5.500	5.610	V	1
I/O voltage difference	V <sub>dif</sub>	I <sub>OUT</sub> = 10 mA	—	0.13	0.43	V	1
Line regulation 1	ΔV <sub>OUT1</sub>	V <sub>IN</sub> = 6.5 to 16 V I <sub>OUT</sub> = 1 mA	—	58	116	mV	1
Line regulation 2	ΔV <sub>OUT2</sub>	V <sub>IN</sub> = 6.5 to 16 V I <sub>OUT</sub> = 1 μA	—	58	385	mV	1
Load regulation	ΔV <sub>OUT3</sub>	V <sub>IN</sub> = 7.5 V I <sub>OUT</sub> = 1 μA to 40 mA	—	40	80	mV	1
Current consumption	I <sub>SS</sub>	V <sub>IN</sub> = 7.5 V, Unloaded	—	1.2	2.5	μA	2
Input voltage	V <sub>IN</sub>		—	—	16	V	—
Temperature characteristic of ΔV <sub>OUT</sub>	$\frac{\Delta V_{OUT}}{\Delta T_a}$	V <sub>IN</sub> = 7.5 V, I <sub>OUT</sub> = 10 mA Ta = -40°C to 85°C	—	± 0.688	—	mV/°C	—

### 24. S-81256SGUP-DIM-X (5.6-V output type)

Table 26

(Unless otherwise specified: Ta = 25°C)

Parameter	Symbol	Conditions	Min.	Typ.	Max.	Unit	Test cir.
Output voltage	V <sub>OUT</sub>	V <sub>IN</sub> = 7.6 V, I <sub>OUT</sub> = 10 mA	5.488	5.600	5.712	V	1
I/O voltage difference	V <sub>dif</sub>	I <sub>OUT</sub> = 10 mA	—	0.12	0.42	V	1
Line regulation 1	ΔV <sub>OUT1</sub>	V <sub>IN</sub> = 6.6 to 16 V I <sub>OUT</sub> = 1 mA	—	59	117	mV	1
Line regulation 2	ΔV <sub>OUT2</sub>	V <sub>IN</sub> = 6.6 to 16 V I <sub>OUT</sub> = 1 μA	—	59	392	mV	1
Load regulation	ΔV <sub>OUT3</sub>	V <sub>IN</sub> = 7.6 V I <sub>OUT</sub> = 1 μA to 40 mA	—	40	80	mV	1
Current consumption	I <sub>SS</sub>	V <sub>IN</sub> = 7.6 V, Unloaded	—	1.2	2.5	μA	2
Input voltage	V <sub>IN</sub>		—	—	16	V	—
Temperature characteristic of ΔV <sub>OUT</sub>	$\frac{\Delta V_{OUT}}{\Delta T_a}$	V <sub>IN</sub> = 7.6 V, I <sub>OUT</sub> = 10 mA Ta = -40°C to 85°C	—	± 0.7	—	mV/°C	—

■ **Test Circuits**

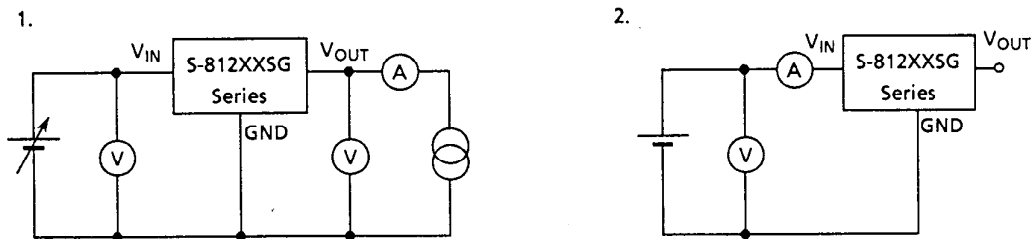

Figure 3

■ **Technical Terms**

1 Output voltage ( $V_{OUT}$ )

The precision of output voltage is guaranteed at  $\pm 2.0\%$  or  $\pm 2.4\%$  under the prescribed conditions of input voltage, output voltage, and temperature, which differ with items. If these conditions are varied, output voltage value may change into beyond the scope of precision of output voltage. See electrical characteristics and characteristics data for detail.

2 Line regulations 1 and 2 ( $\Delta V_{OUT1}$ ,  $\Delta V_{OUT2}$ )

Indicates the input voltage dependencies of output voltage. That is, the values express how the output voltage changes, when input voltage is changed under the condition that output current is fixed.

3 Load regulation ( $\Delta V_{OUT3}$ )

Indicates the output current dependencies of output voltage. That is, the values express how the output voltage changes, when output current is changed under the condition that input voltage is fixed.

4 I/O voltage difference ( $V_{dif}$ )

98% of  $V_{OUT}$  is output when the voltage of  $V_{OUT} + V_{dif}$  is applied. When  $V_{dif}$  is small, output keeps a constant voltage in the small side of input voltage and large output current can be obtained.

**NOTE :**  $V_{dif}$  is highly dependent on  $I_{OUT}$ .

■ **Operation**

1 Basic operation

Figure 4 shows the block diagram of the S-812XXSG Series. The error amplifier compares a reference voltage  $V_{REF}$  with a part of the output voltage fed back by the feedback resistors  $R_A$  and  $R_B$ . It supplies the control transistor with the gate current, necessary to keep a stable output voltage range not influenced by input voltage or temperature fluctuation.

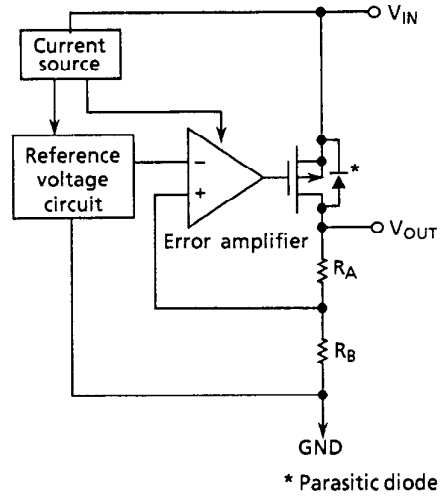

Figure 4 Reference block diagram

2 Internal circuit

2.1 Reference voltage circuit

In a voltage regulator, the reference voltage circuit plays a very important role because any change will show up directly at an output.

The S-812XXSG Series has 0.8 V typical stable voltage circuit as a highly stable reference voltage source.

Features:

- Low power consumption
- Good temperature characteristic

2.2 Error amplifier

The error amplifier consumes very low current because it is a differential amplifier in a stable current circuit.

Features:

- Good matching characteristics
- Wide operating voltage range
- Low offset voltage

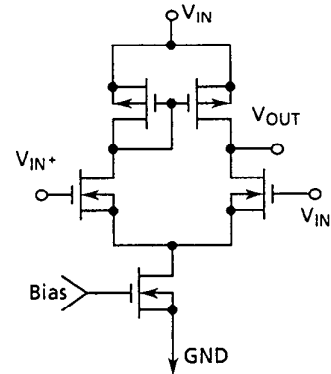

Figure 5 Error amplifier

2.3 Control transistor

The S-812XXSG Series has a Pch MOS transistor as a current control transistor shown in Figure 6. Therefore an output current  $I_{OUT}$  is expressed by the following formula where is only a small difference between input and output voltages:

$$I_{OUT} = KP \{ 2(V_{GS} - V_{TP})(V_{IN} - V_{OUT}) - (V_{IN} - V_{OUT})^2 \}$$

\* KP : Conductive coefficient

$V_{TP}$  : Threshold voltage of a control transistor

Setting KP to the large value results in a voltage regulator with 160 mV typical I/O voltage difference.

**NOTE:** A parasitic diode is generated between  $V_{IN}$  and  $V_{OUT}$ . If the electric potential of  $V_{IN}$  is higher than that of  $V_{OUT}$ , IC may break because of a reverse current. Keep  $V_{OUT}$  less than  $V_{IN} + 0.3$  V.

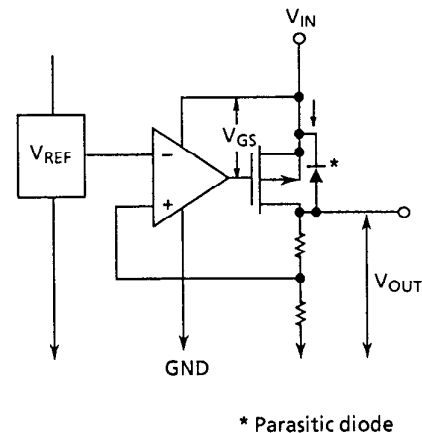

Figure 6 Control transistor

3 Temperature characteristic of output voltage

The temperature characteristic of the output voltage is expressed by the following formula in the range of -40°C to 85°C.

$$\frac{V_{OUT}}{V_{REF}} \times (\pm 0.1) \text{ mV/}^\circ\text{C typ.}$$

\*  $V_{REF}$  is 0.7 V min., 0.8 V typ., 0.9 V max.

■ **Transient Response**

1. Line transient response

The overshoot and undershoot are caused in the output voltage if the input voltage fluctuates while the output current is constant. Figure 7 shows the output voltage fluctuation due to input voltage change between 6.0 V and 10 V in square wave. Table 19 shows the parameter dependency when input voltage fluctuates. For reference, Figure 8 describes the measurement circuit.

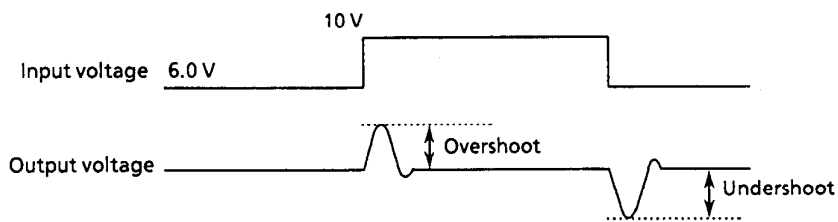

Figure 7 Output voltage fluctuation due to input voltage fluctuation

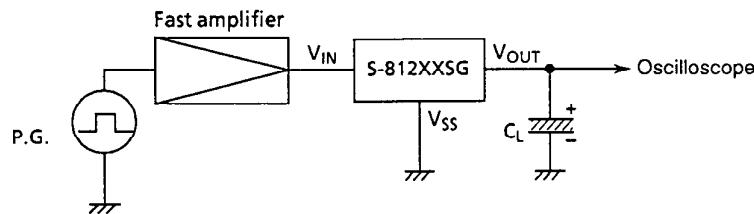

Figure 8 Measuring circuit

Table 27 Parameter dependency due to input voltage fluctuation

Parameter	Method to decrease overshoot	Method to decrease undershoot
Output current $I_{OUT}$	Decrease	Decrease
Load capacitance $C_L$	Increase	Increase
Input voltage fluctuation $\Delta V_{IN}^*$	Decrease	Decrease
Temperature $T_a$	—	High temperature

\*  $\Delta V_{IN}$ : High voltage value – low voltage value

For reference, the next page describes the results of measuring the ringing amounts at the  $V_{OUT}$  pin using the output current ( $I_{OUT}$ ), load capacitance ( $C_L$ ), input voltage fluctuation width ( $\Delta V_{IN}$ ), and temperature as parameters.

# HIGH-PRECISION VOLTAGE REGULATOR S-812XXSG Series

Reference data Line transient response of S-81250SG

### 1. $I_{OUT}$ dependency

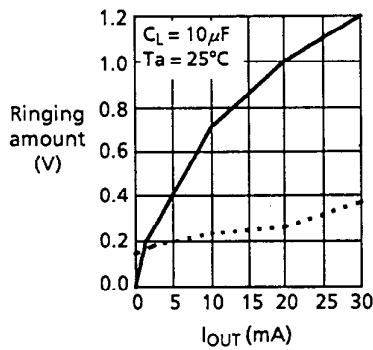

### 2. $C_L$ dependency

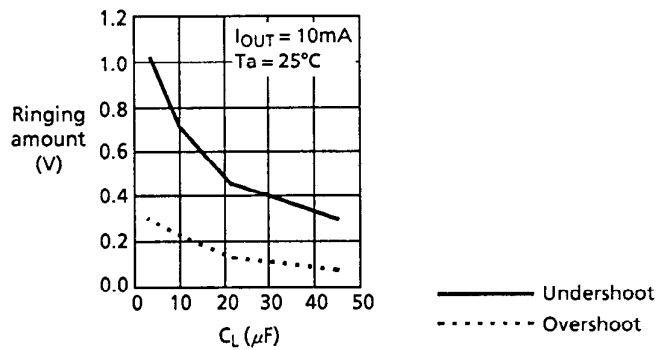

### 3. $\Delta V_{IN}$ dependency

$\Delta V_{IN}$  shows the difference between the low voltage fixed to 6 V and the high voltage. For example,  $\Delta V_{IN} = 2$  V means the difference between 6 V and 8 V.

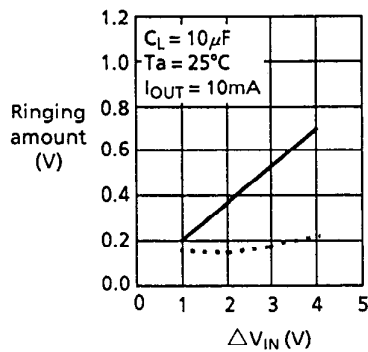

### 4. Temperature dependency

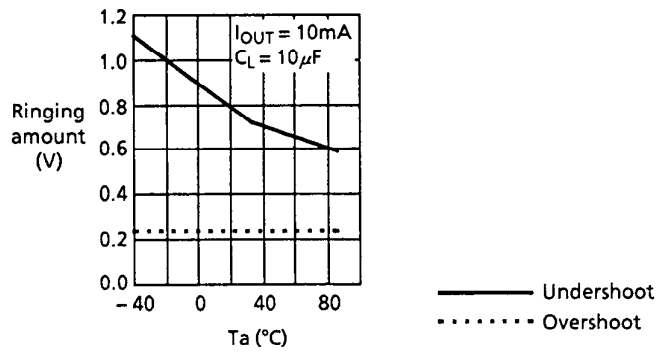

### 2. Load transient response

The overshoot and undershoot are caused in the output voltage if the output current fluctuates while the input voltage is constant. Figure 9 shows the output voltage fluctuation due to output current change between 10mA and 1  $\mu$ A in square wave. Table 20 shows the parameter dependency when output current fluctuates. For reference, Figure 10 describes the measuring circuit.

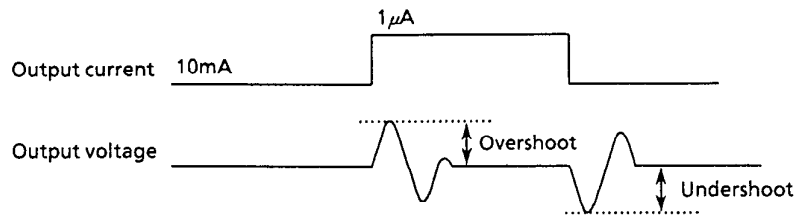

Figure 9 Output voltage fluctuation due to output current fluctuation

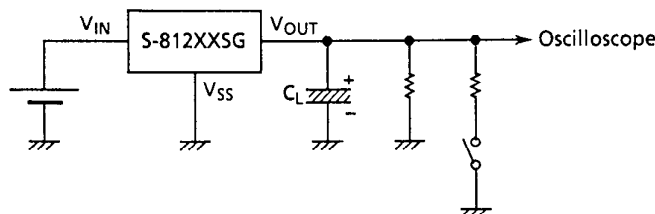

Figure 10 Measuring circuit

**Table 28 Parameter dependency due to output current fluctuation**

Parameter	Method to decrease overshoot	Method to decrease undershoot
Output current fluctuation $\Delta I_{OUT}$	Decrease	Decrease
Load capacitance $C_L$	Increase	Increase
Input voltage $V_{IN}$	Increase	Increase
Temperature $T_a$	—	—

For reference, the following describes the results of measuring the ringing amounts at the  $V_{OUT}$  pin using the input voltage ( $V_{IN}$ ), load capacitance ( $C_L$ ), output current fluctuation width ( $\Delta I_{OUT}$ ), and temperature as parameters.

**Reference data**    Load transient response of S-81250SG

1.  $V_{IN}$  dependency

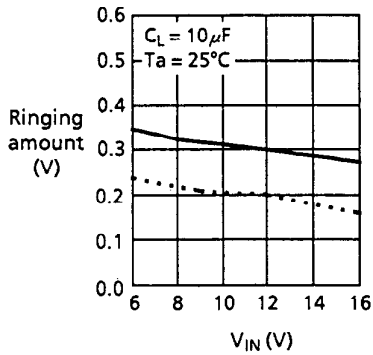

2.  $C_L$  dependency

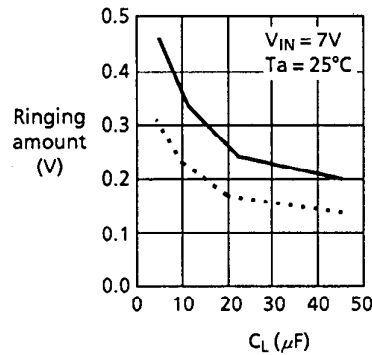

3.  $\Delta I_{OUT}$  dependency

$\Delta I_{OUT}$  shows the difference between the low current fixed to  $1 \mu A$  and the high. For example,  $\Delta I_{OUT} = 10 \text{ mA}$  means the difference between 10mA and  $1 \mu A$ .

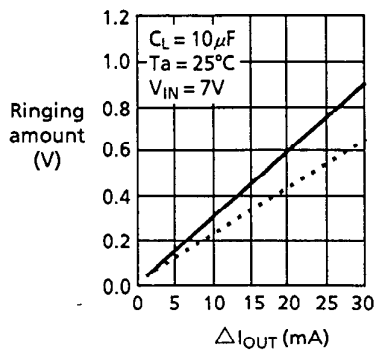

4. Temperature dependency

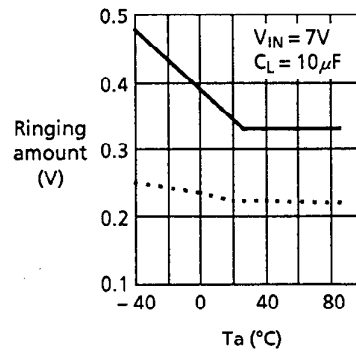

Undershoot  
 Overshoot



# HIGH-PRECISION VOLTAGE REGULATOR

## S-812XXSG Series

### Standard Circuit

The basic circuit using the S-812XXSG Series is shown in Figure 11.

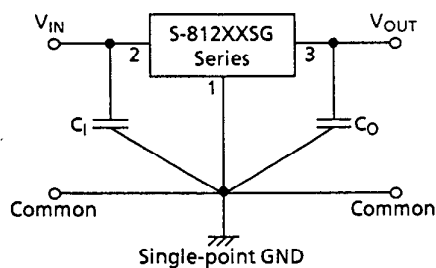

Figure 11

### Application Circuits

#### 1. High output current positive voltage regulator

Figure 12 shows a circuit for increasing the output current.

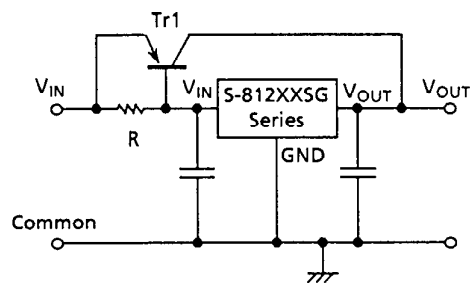

Figure 12

Short-circuit protection of Tr1 is possible by adding the sense resistor  $R_S$  and the PNP transistor as shown in Figure 13.

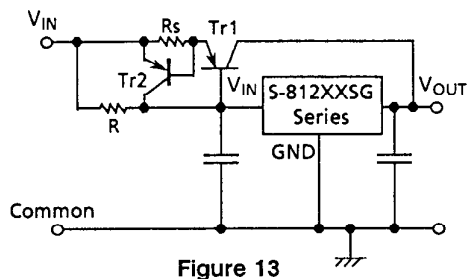

Figure 13

2. Circuits for increasing output voltage

If the output voltage you need cannot be found in our product line-up, the designs in Figures 14 or 15 will increase output voltages easily.

$$V_{OUT} = V_{XX} \left(1 + \frac{R_2}{R_1}\right) + I_{SS} \cdot R_2 = V_{XX} \left(1 + \frac{R_2}{R_1}\right)$$

Because of its low current consumption, the S-812XXSG Series can set the resistor values, and R<sub>1</sub> and R<sub>2</sub> high to lower the power consumption of whole systems.

Current flows to the Zener diode (Di) through the quiescent current (I<sub>SS</sub>) of the S-812XXSG Series, and the GND terminal rises for the voltage of Di.

When Di cannot drive with a quiescent current, the added resistance R increases the current flowing through Di.

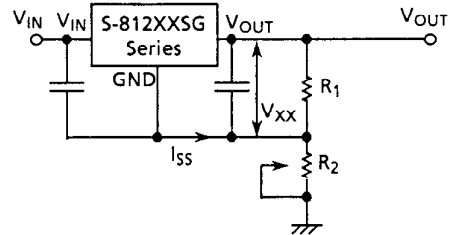

Figure 14

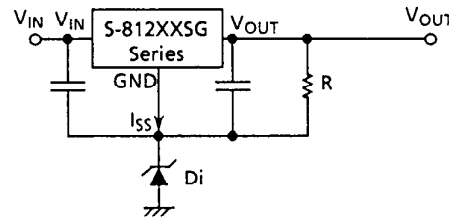

Figure 15

3. Constant current regulator

The S-812XXSG Series can be used as a constant-current regulator within allowable dissipation limits.

$$I_{OUT} = \frac{V_{XX}}{R_A} + I_{SS}$$

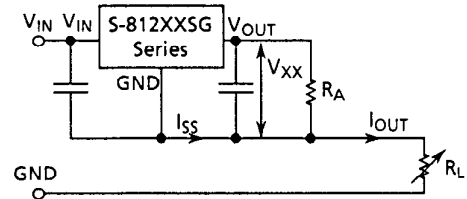

Figure 16 Constant current regulator

4. Dual supply

A dual supply can be formed using the S-812XXSG Series.

Figure 17 shows a circuit example for receiving two outputs (5 V and 8 V) with the S-81230SG and the S-81250SG. As the resistance R lets the quiescent current of IC1 pass, R is unnecessary if the minimum output current of IC2 is more than the IC1 quiescent current.

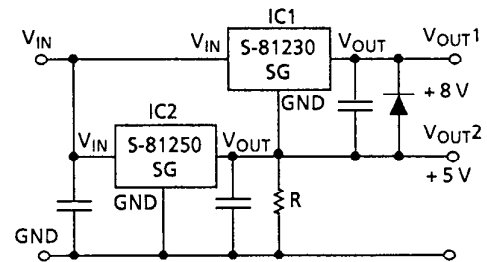

Figure 17 Dual power source

# HIGH-PRECISION VOLTAGE REGULATOR

## S-812XXSG Series

---

### ■ Notes on Design

- Voltage regulators may oscillate if small or zero capacity is connected to IC input when the impedance of the power source is high and a large capacity is connected to IC output.
- The S-812XXSG Series has no short-current circuit limiting. The element may break by exceed current of erroneous short-current.
- Keep the output current more than  $10 \mu\text{A}$  when using the product of  $V_{\text{OUT}} \leq 2.6 \text{ V}$  under the condition of high input voltage and high temperature.
- Do not apply any ripple voltage under the condition in Figure 18 to  $V_{\text{IN}}$  terminal.

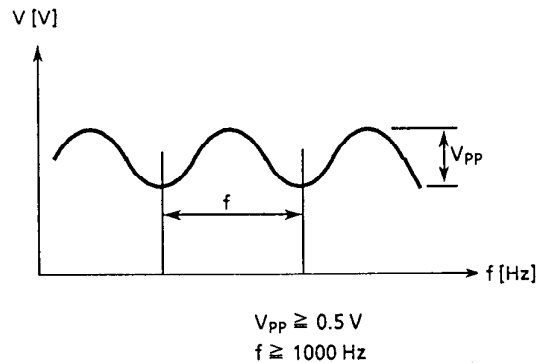

Figure 18

- Mount diodes for IC protection, when connecting another power supply to  $V_{\text{OUT}}$  terminal.

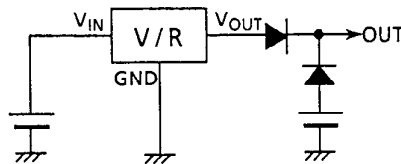
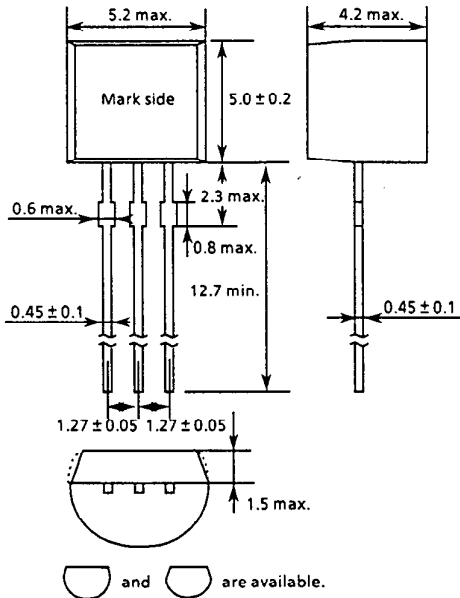

Figure 19

- When designing for mass production using an application circuit described here, keep the deviation of components and temperature characteristic.

■ Dimensions

(1) TO-92



(2) SOT-89-3

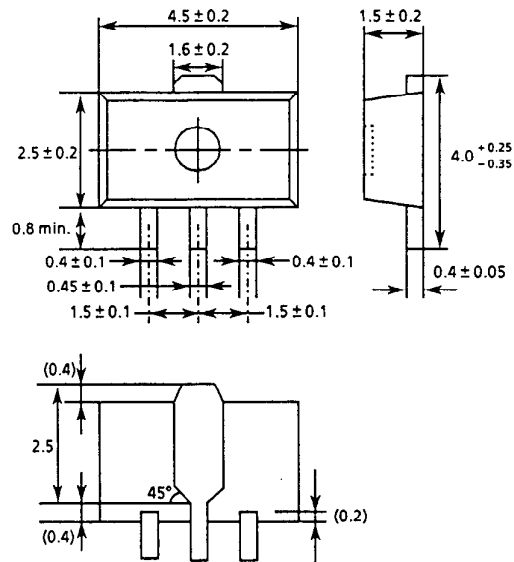

(3) SOT-23-5

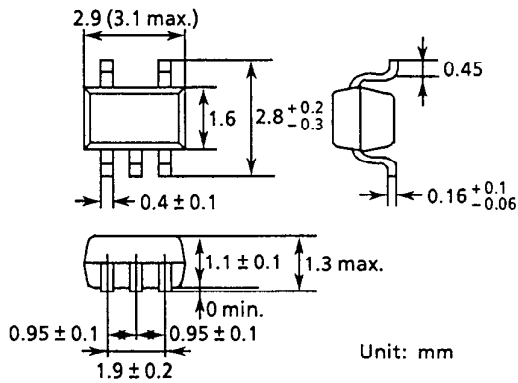
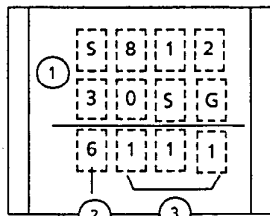

Figure 20

■ Markings

(1) TO-92



- ① Product name
- ② Last digit of the year
- ③ Lot No.

(2) SOT-89-3

(1) White label

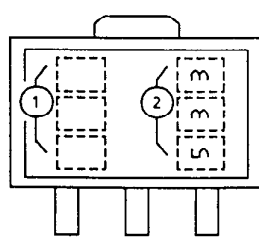

- ① Product name (abbreviation)
- ② Lot NO.

(2) Blue label

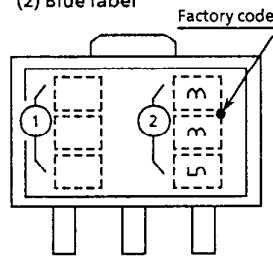

- ① Product name (abbreviation)
- ② Lot NO.

(3) SOT-23-5

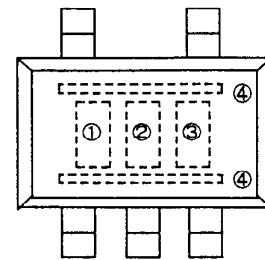

- ① to ② Product name (abbreviation)
- ③ to ④ Lot NO.
- ③: Alphabet
- ④: Dot on one side

Figure 21

# HIGH-PRECISION VOLTAGE REGULATOR

## S-812XXSG Series

### ■ Package Power Dissipation

(1) TO-92

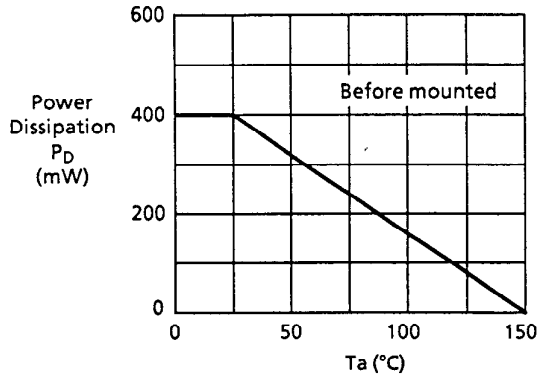

(2) SOT-89-3

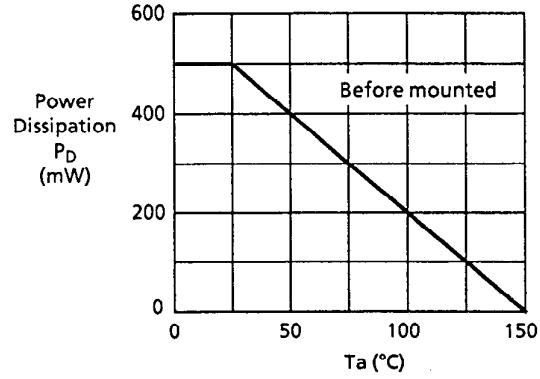

(3) SOT-23-5

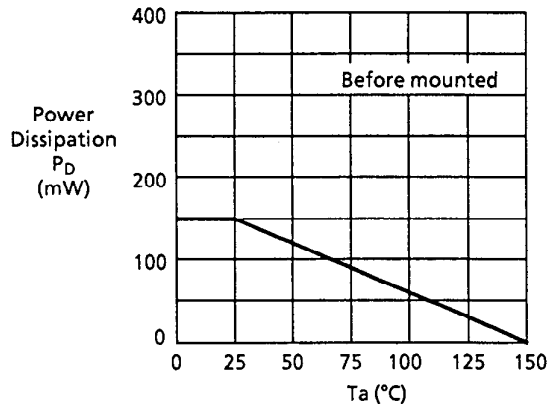

Figure 22

■ Taping Dimensions

1. SOT-89-3

1.1 Tape specifications

T1 and T2 types are available depending upon the direction of ICs on the tape.

(1) White label (without a hole in the center of embossed area)

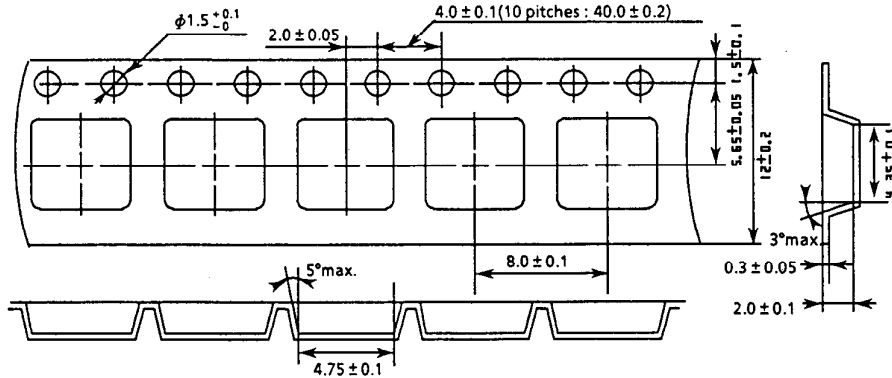
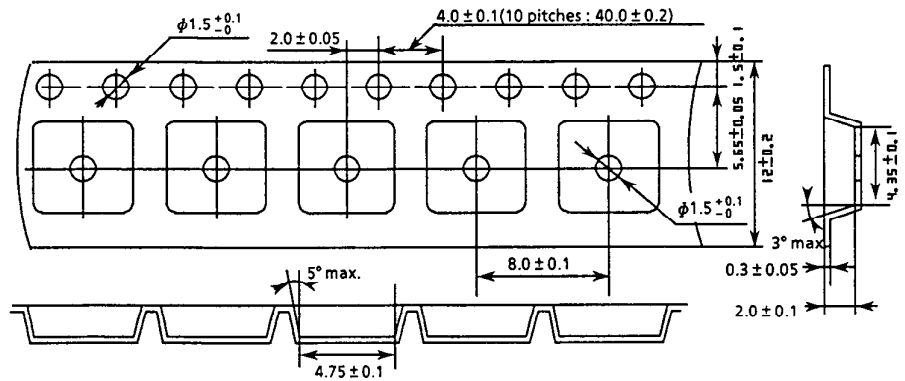

Figure 23

(2) Blue label (with a hole in the center of embossed area)



Unit: mm

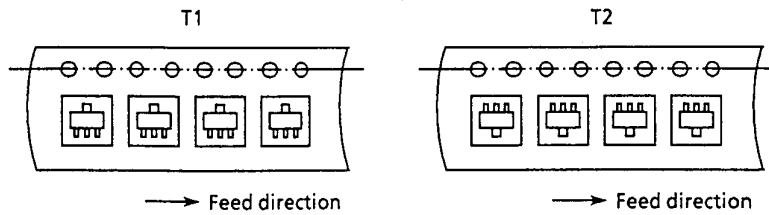

Figure 24

# HIGH-PRECISION VOLTAGE REGULATOR S-812XXSG Series

## 1.2 Reel specifications

1 reel holds 1000 regulators.

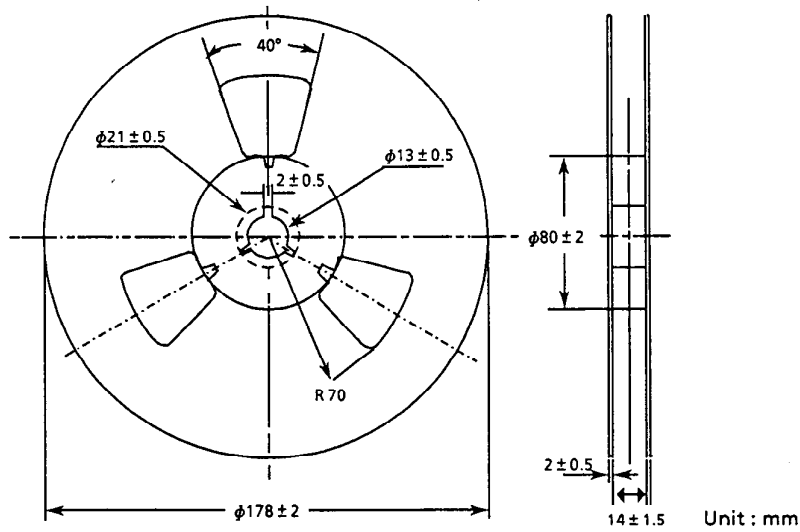

Figure 25

## 1.3 Magazine Dimensions

1 stick holds 25 regulators.

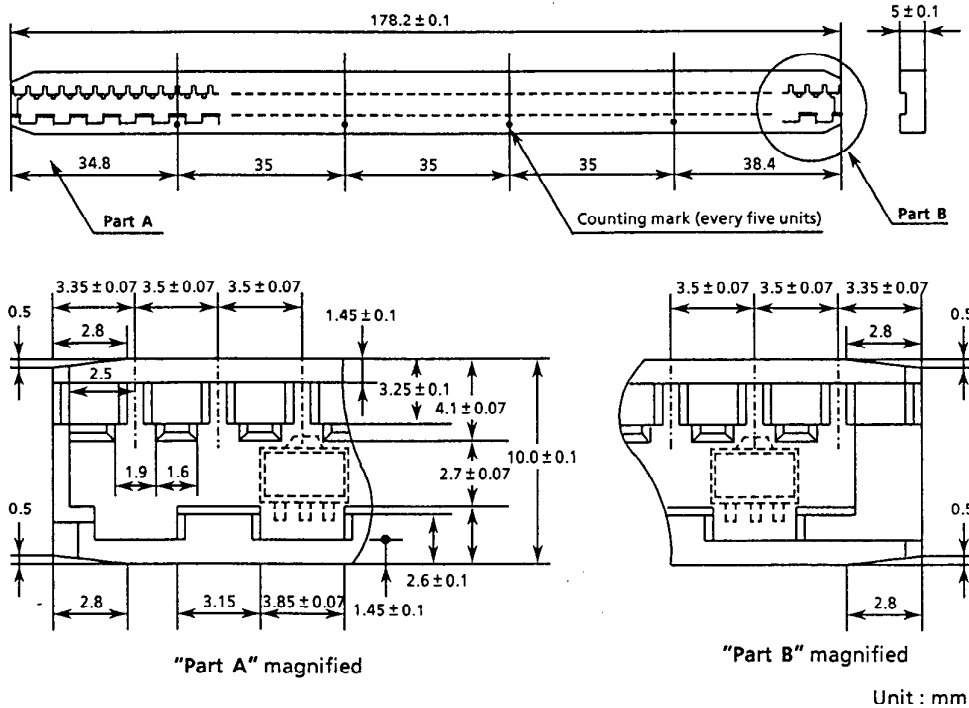

Figure 26

2. SOT-23-5

2.1 Tape specifications

T1 and T2 types are available depending upon the direction of ICs on the tape.

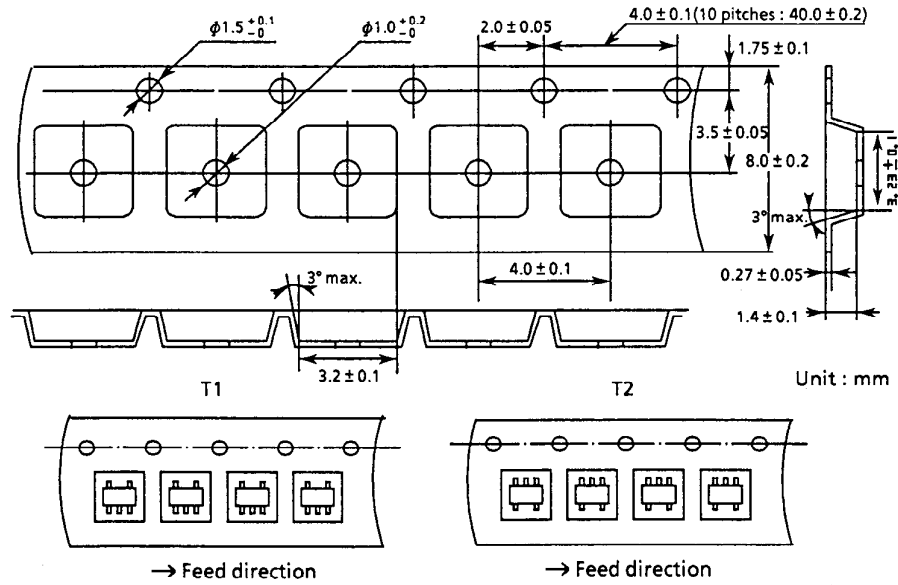

Figure 27

The top cover tape comes in 2 tones ; opaque, semi-transparent and transparent.

2.2 Reel specifications

1 reel holds 3000 regulators.

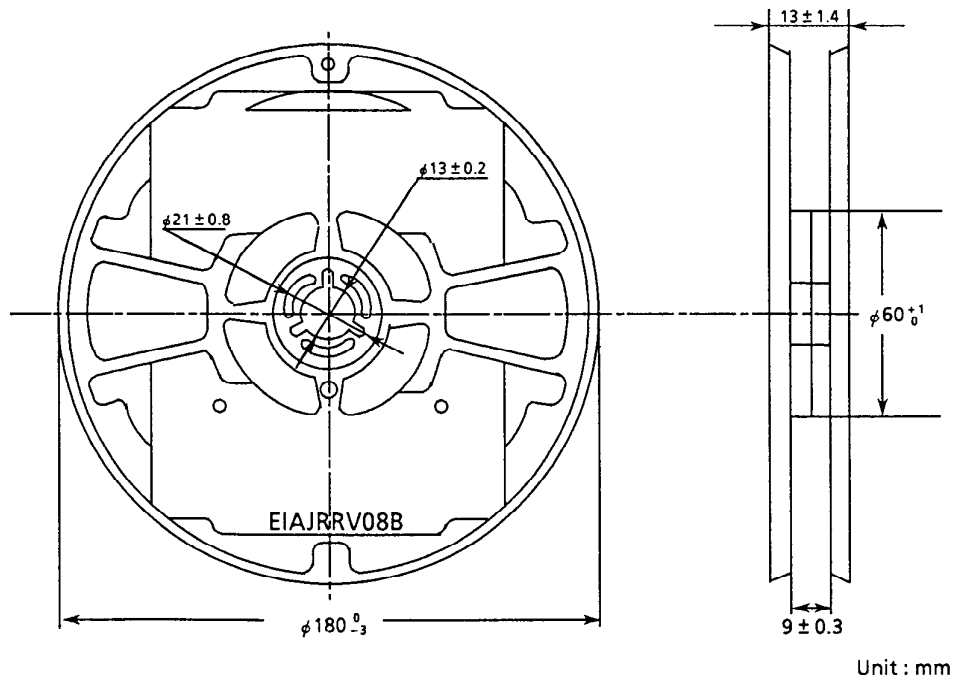

Figure 28



# HIGH-PRECISION VOLTAGE REGULATOR

## S-812XXSG Series

### Characteristics

#### 1 Input voltage - output voltage

##### 1.1 S-81211SG series

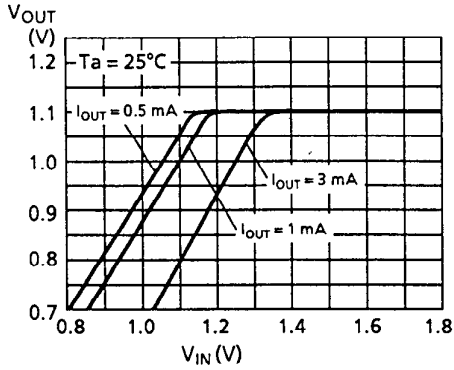

##### 1.2 S-81215SG series

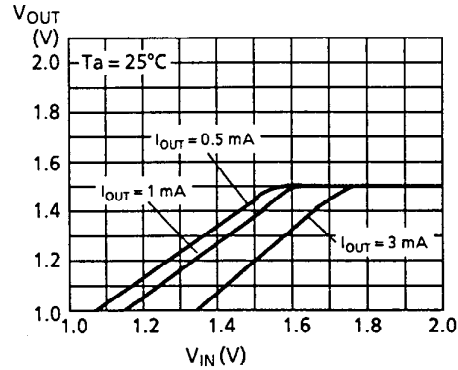

##### 1.3 S-81220SG series

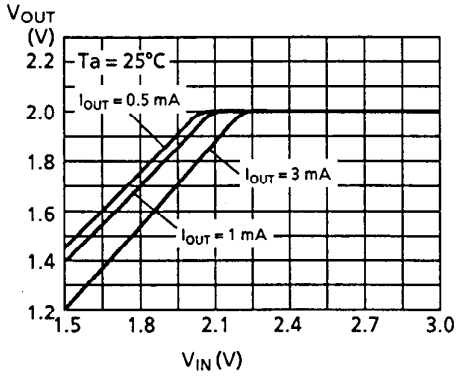

##### 1.4 S-81225SG series

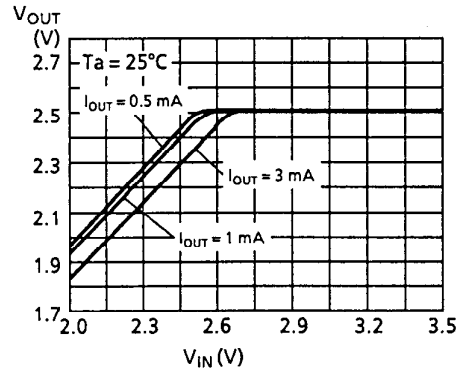

##### 1.5 S-81230SG series

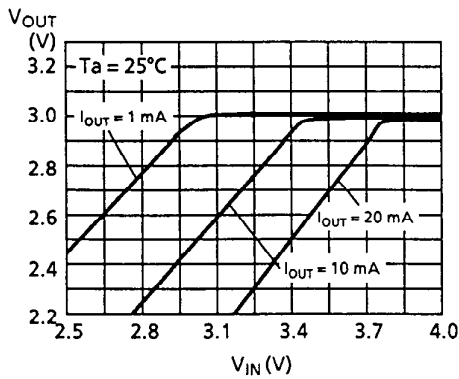

##### 1.6 S-81235SG series

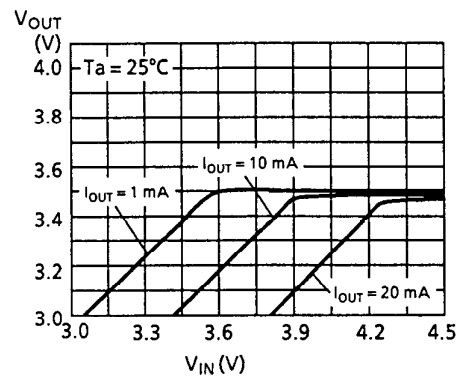

##### 1.7 S-81240SG series

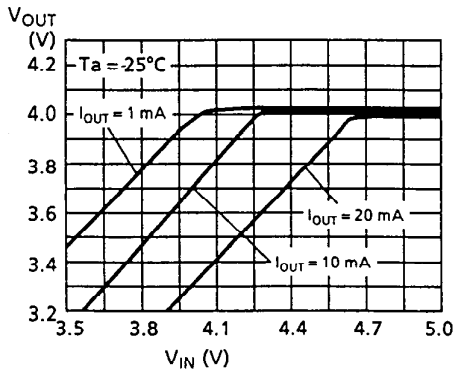

##### 1.8 S-81245SG series

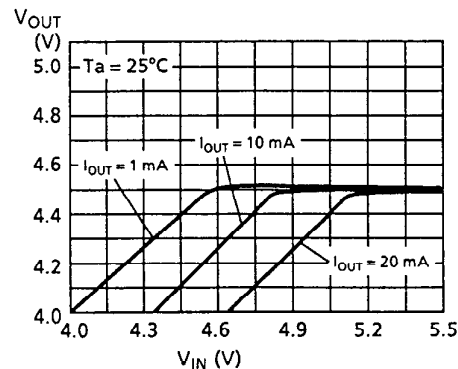

1.9 S-81250SG series

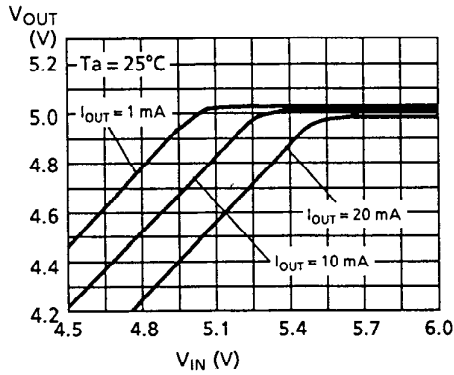

2. Output current - output voltage

2.1 S-81211SG series

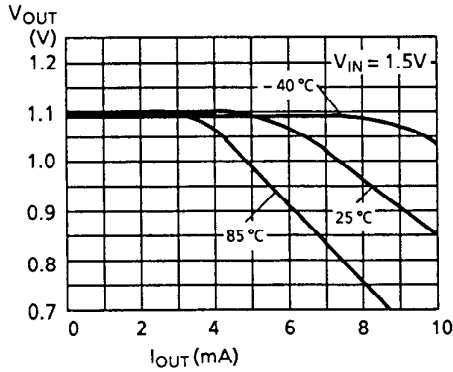

2.2 S-81215SG series

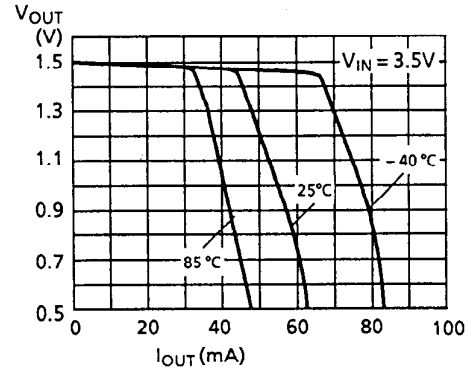

2.3 S-81220SG series

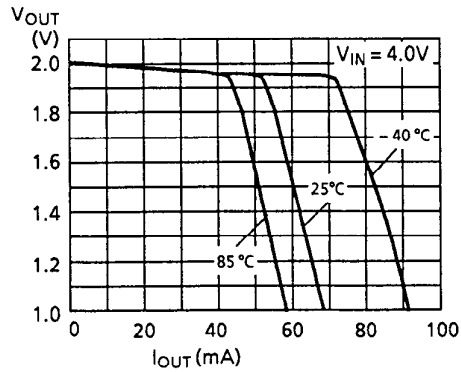

2.4 S-81225SG series

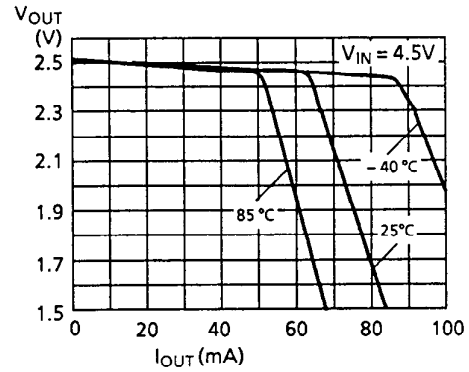

2.5 S-81230SG series

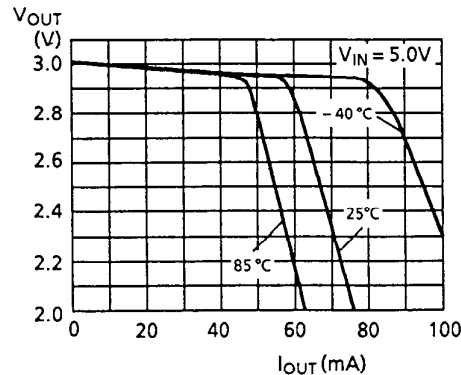

2.6 S-81235SG series

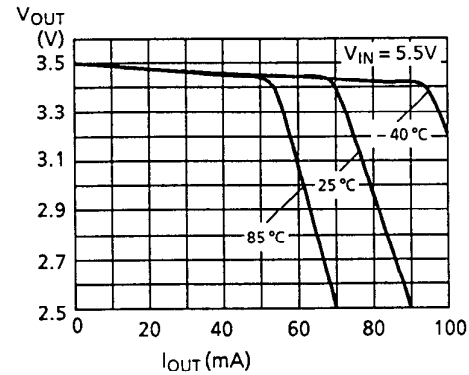

# HIGH-PRECISION VOLTAGE REGULATOR S-812XXSG Series

2.7 S-81240SG series

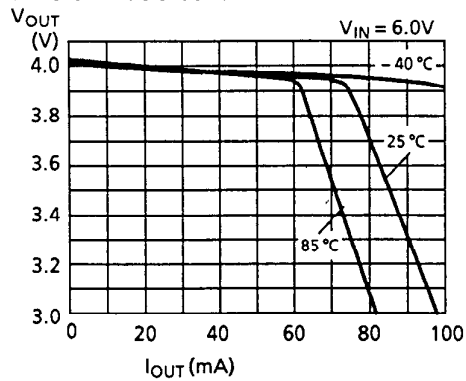

2.8 S-81245SG series

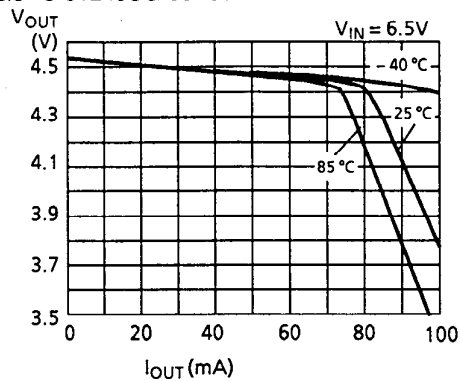

2.9 S-81250SG series

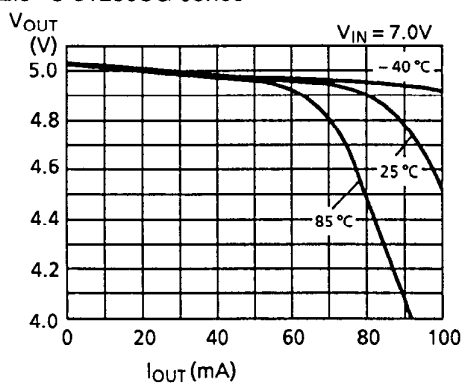

### 3. Output current - output voltage (at low load)

3.1  $V_{OUT} \leq 1.4V$

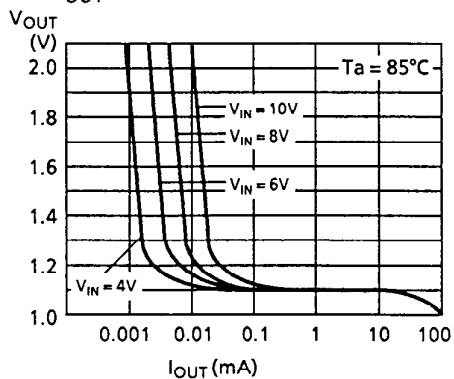

3.2  $1.5V \leq V_{OUT} \leq 2.6V$

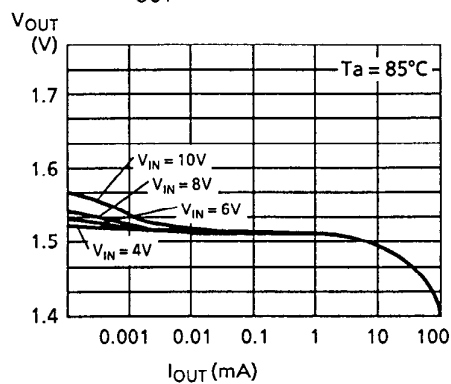

3.3  $V_{OUT} \leq 2.7V$

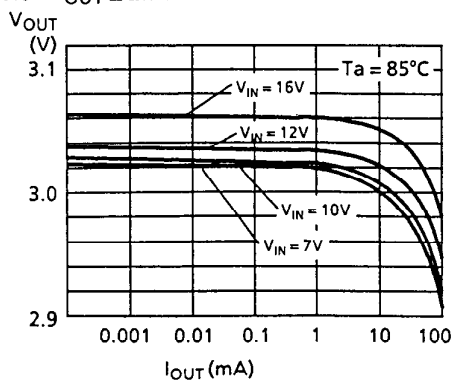

4. Input voltage - current consumption

S-81250SG series

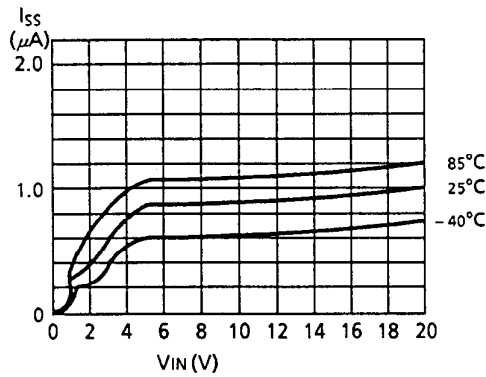

5. Temperature characteristic of output voltages

5.1  $V_{OUT} \leq 1.3 V$

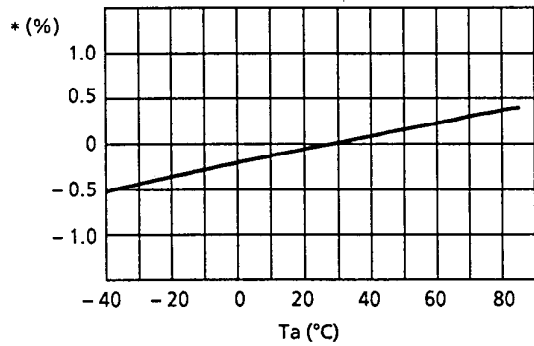

5.2  $V_{OUT} \geq 1.4 V$

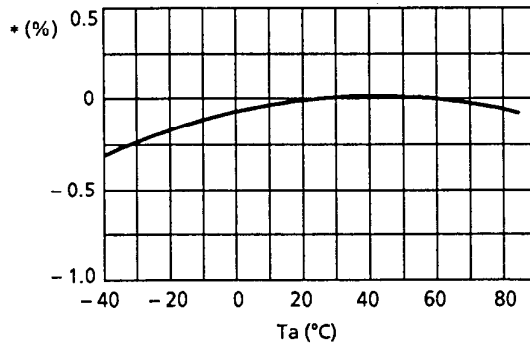

\* Definite with fluctuation ratio based on the output voltage at  $T_a = 25^{\circ}C$

6. I/O voltage difference characteristics

6.1 S-81211SG series

(V<sub>initial</sub>: Output voltage value at  $V_{IN} = 1.5 V$  and  $I_{OUT} = 0.5 mA$ )

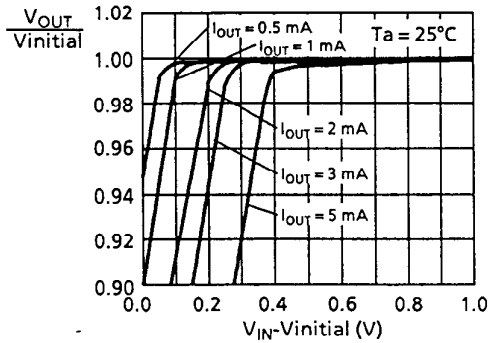

6.2 S-81215PG series

(V<sub>initial</sub>: Output voltage value at  $V_{IN} = 3.5 V$  and  $I_{OUT} = 0.5 mA$ )

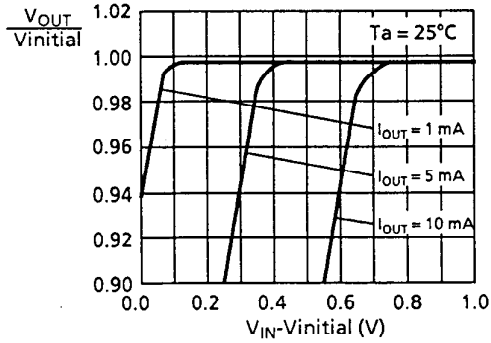

# HIGH-PRECISION VOLTAGE REGULATOR

## S-812XXSG Series

### 6.3 S-81220SG series

(Vinitial: Output voltage value at  $V_{IN} = 4.0\text{ V}$  and  $I_{OUT} = 10\text{ mA}$ )

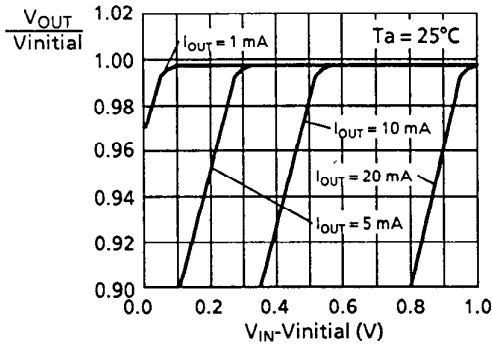

### 6.4 S-81225SG series

(Vinitial: Output voltage value at  $V_{IN} = 4.5\text{ V}$  and  $I_{OUT} = 10\text{ mA}$ )

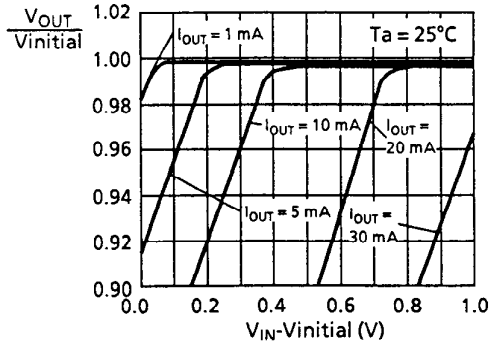

### 6.5 S-81230SG series

(Vinitial: Output voltage value at  $V_{IN} = 5.0\text{ V}$  and  $I_{OUT} = 10\text{ mA}$ )

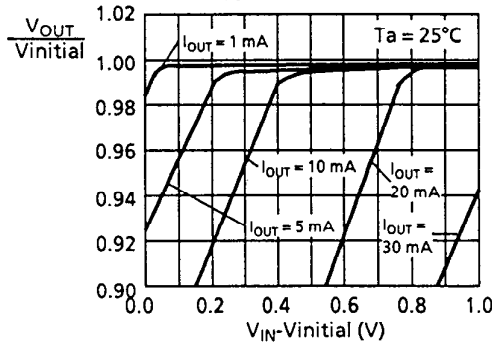

### 6.6 S-81235SG series

(Vinitial: Output voltage value at  $V_{IN} = 5.5\text{ V}$  and  $I_{OUT} = 10\text{ mA}$ )

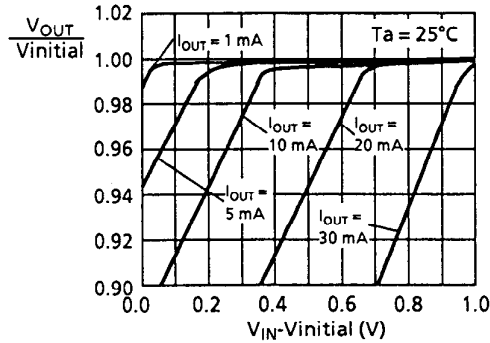

### 6.7 S-81240SG series

(Vinitial: Output voltage value at  $V_{IN} = 6.0\text{ V}$  and  $I_{OUT} = 10\text{ mA}$ )

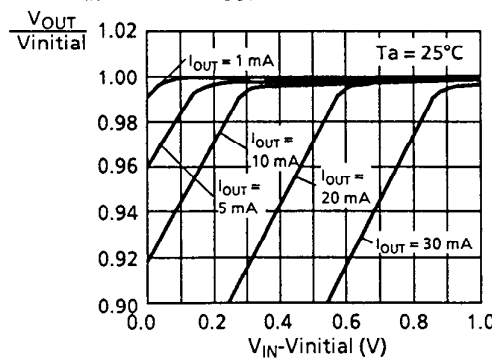

### 6.8 S-81245SG series

(Vinitial: Output voltage value at  $V_{IN} = 6.5\text{ V}$  and  $I_{OUT} = 10\text{ mA}$ )

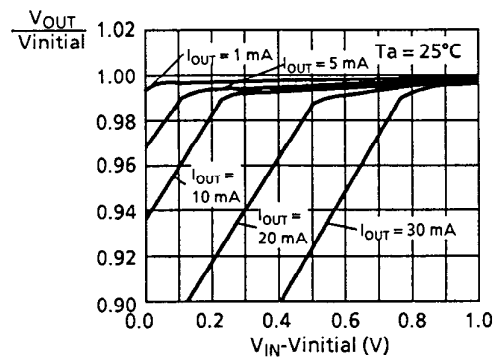

### 6.9 S-81250PG series

(Vinitial: Output voltage value at  $V_{IN} = 7.0\text{ V}$  and  $I_{OUT} = 10\text{ mA}$ )

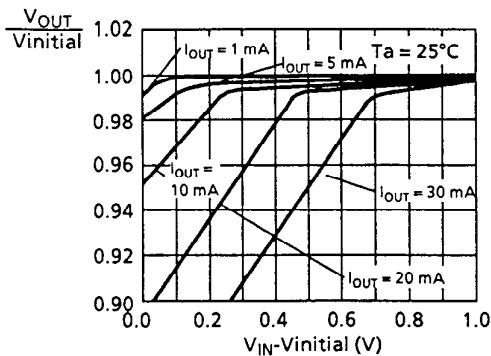

7. Temperature characteristic of I/O voltage difference

7.1 S-81211SG series

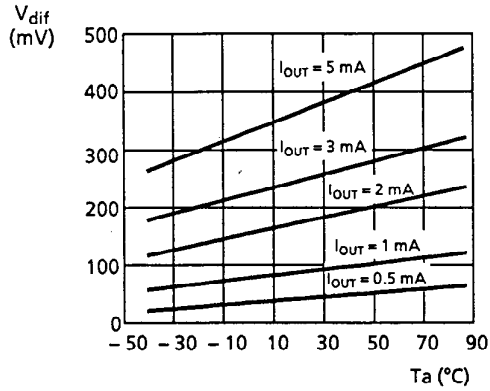

7.2 S-81215SG series

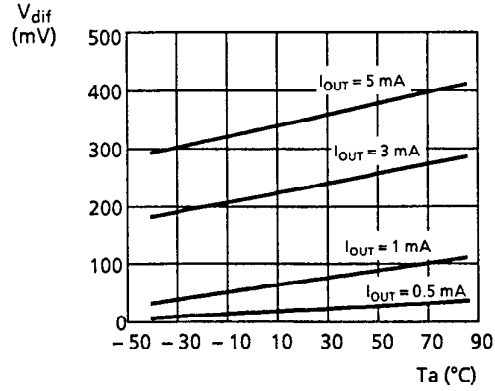

7.3 S-81220SG series

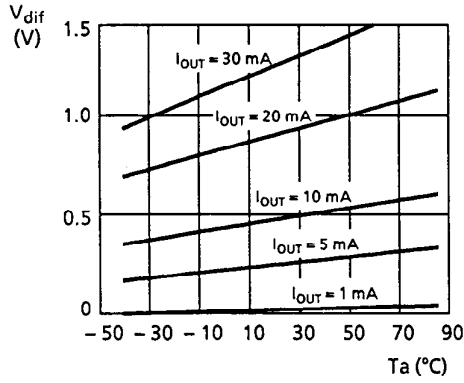

7.4 S-81225SG series

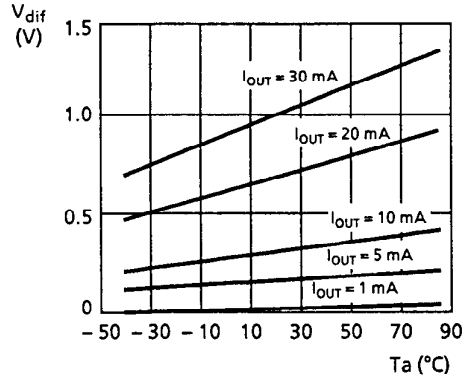

7.5 S-81230SG series

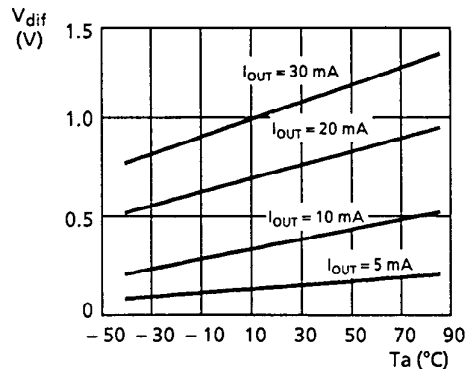

7.6 S-81235SG series

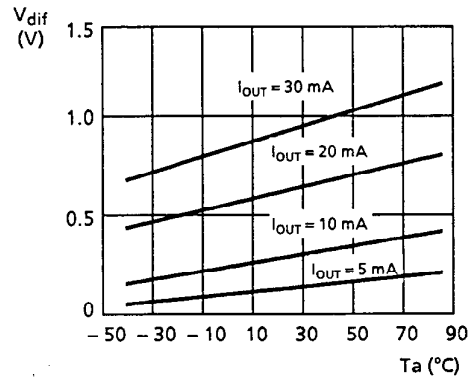

7.7 S-81240SG series

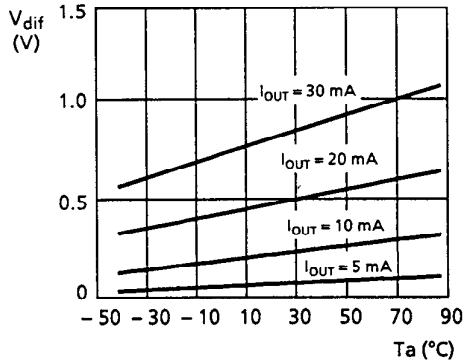

7.8 S-81245SG series

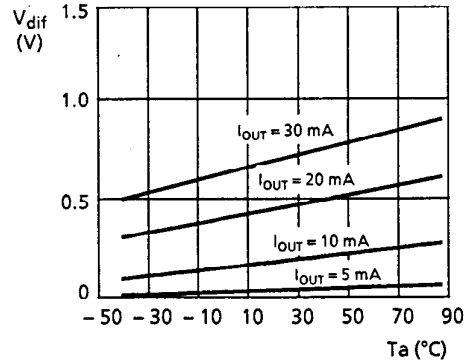

7.9 S-81250SG series

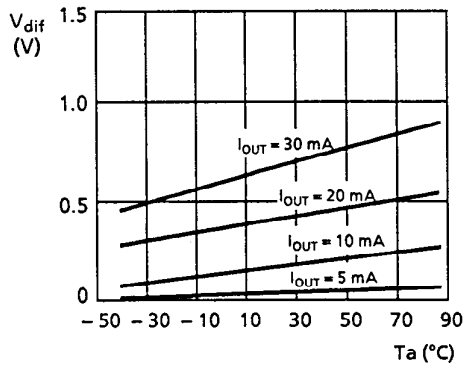

■ **Measuring Circuits**

1. Input voltage - output voltage

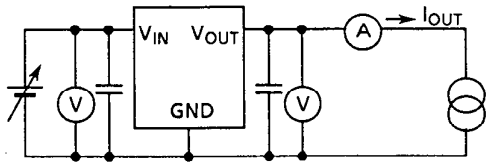

2. Output current - output voltage

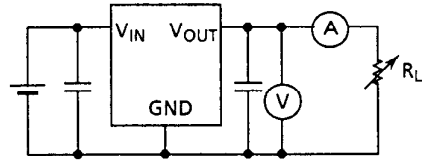

3. Current consumption

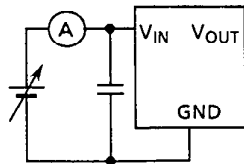

Figure 29