LOW DROPOUT CMOS VOLTAGE REGULATOR S-818 Series

The S-818 Series is a positive voltage regulator developed utilizing CMOS technology featured by low dropout voltage, high output voltage accuracy and low current consumption. Built-in low on-resistance transistor provides low dropout voltage and large output current. A ceramic capacitor of 2 μ F or more can be used as an output capacitor. A power-OFF circuit ensures long battery life.

The SOT-23-5 miniaturized package and the SOT-89-5 package are recommended for configuring portable devices and large output current applications, respectively.

■ Features

- Low current consumption
During operation: Typ. 30 μ A, Max. 40 μ A
During power off: Typ. 100 nA, Max. 500 nA
- Output voltage: 0.1 V steps between 2.0 and 6.0 V
- High accuracy output voltage: $\pm 2.0\%$
- Peak output current;
200 mA capable (3.0 V output product, $V_{IN}=4$ V) ^{Note}
300 mA capable (5.0 V output product, $V_{IN}=6$ V) ^{Note}
- Low dropout voltage
Typ. 170 mV (5.0 V output product, $I_{OUT} = 60$ mA)
A ceramic capacitor (2 μ F or more) can be used as an output capacitor.
- Built-in power-off circuit
- Compact package: SOT-23-5, SOT-89-5

■ Applications

- Power source for battery-powered devices
- Power source for personal communication devices
- Power source for home electric/electronic appliances

Note : Please consider power dissipation of the package when the output current is large.

■ Package

- 5-pin SOT-23-5 (Package drawing code: MP005-A)
- 5-pin SOT-89-5 (Package drawing code: UP005-A)

■ Block Diagram

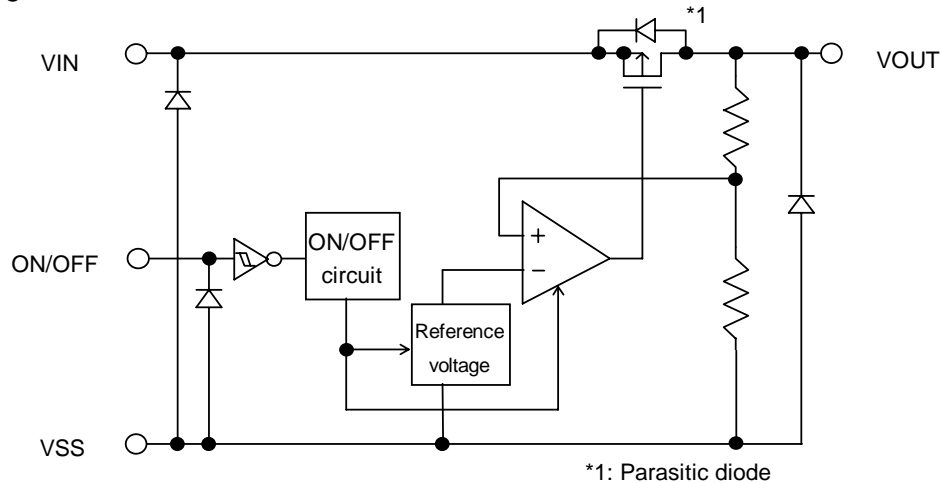

Figure 1 Block Diagram

■ Selection Guide

1. Product Name

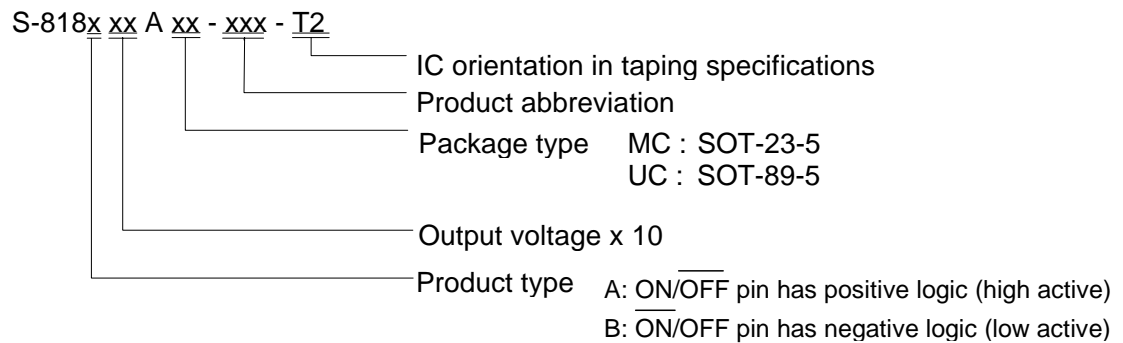

Table 1 Selection Guide

Output Voltage	SOT-23-5	SOT-89-5
2.0 V \pm 2.0%	S-818A20AMC-BGA-T2	S-818A20AUC-BGA-T2
2.5 V \pm 2.0%	S-818A25AMC-BGF-T2	S-818A25AUC-BGF-T2
2.8 V \pm 2.0%	S-818A28AMC-BGI-T2	S-818A28AUC-BGI-T2
3.0 V \pm 2.0%	S-818A30AMC-BGK-T2	S-818A30AUC-BGK-T2
3.3 V \pm 2.0%	S-818A33AMC-BGN-T2	S-818A33AUC-BGN-T2
3.8 V \pm 2.0%	S-818A38AMC-BGS-T2	S-818A38AUC-BGS-T2
4.0 V \pm 2.0%	S-818A40AMC-BGU-T2	S-818A40AUC-BGU-T2
5.0 V \pm 2.0%	S-818A50AMC-BHE-T2	S-818A50AUC-BHE-T2

Note:

Contact SII sales division for product with an output voltage other than those specified above or product type B, low active product.

■ Pin Configuration

Please refer to the package drawings at the end of this document for details.

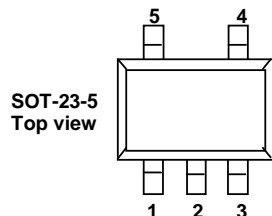

Figure 2 SOT-23-5

Table 2 Pin Assignment

Pin No.	Symbol	Description
1	VIN	Voltage input pin
2	VSS	GND pin
3	ON/OFF	Power off pin
4	NC ^{Note}	No connection
5	VOUT	Voltage output pin

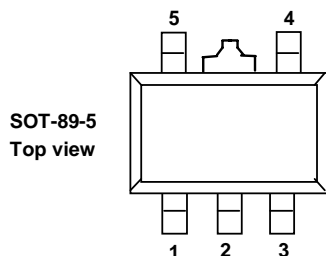

Figure 3 SOT-89-5

Table 3 Pin Assignment

Pin No.	Symbol	Description
1	VOUT	Voltage output pin
2	VSS	GND pin
3	NC ^{Note}	No connection
4	ON/OFF	Power off pin
5	VIN	Voltage input pin

Note: NC means electrical open. Connecting NC pin to VIN or VSS is allowed.

■ Absolute Maximum Ratings

Table 4 Absolute Maximum Ratings

(Ta=25°C unless otherwise specified)

Parameter	Symbol	Absolute Maximum Rating	Unit
Input voltage	VIN	12	V
	VON / OFF	VSS-0.3 to 12	V
Output voltage	VOUT	VSS-0.3 to VIN+0.3	V
Power dissipation	PD	250 (SOT-23-5) 500 (SOT-89-5)	mW
Operating temperature range	Tope	-40 to +85	°C
Storage temperature range	Tstg	-40 to +125	°C

The IC has a protection circuit against static electricity. DO NOT apply high static electricity or high voltage that exceeds the performance of the protection circuit to the IC.

■ Electrical Characteristics

S-818AXXAMC/UC, S-818BXXAMC/UC

Table 5 Electrical Characteristics (Ta=25°C unless otherwise specified)

Parameter	Symbol	Conditions	Min.	Typ.	Max.	Units	Test circuits	
Output voltage *1)	V _{OUT(E)}	V _{IN} =V _{OUT(S)} +1V, I _{OUT} =30mA	V _{OUT(S)} ×0.98	V _{OUT(S)}	V _{OUT(S)} ×1.02	V	1	
Output current *2)	I _{OUT}	V _{OUT(S)} +1V ≤ V _{IN} ≤10V	2.0V ≤ V _{OUT(S)} ≤ 2.4V	100 *5)	—	—	mA	3
			2.5V ≤ V _{OUT(S)} ≤ 2.9V	150 *5)	—	—	mA	3
			3.0V ≤ V _{OUT(S)} ≤ 3.9V	200 *5)	—	—	mA	3
			4.0V ≤ V _{OUT(S)} ≤ 4.9V	250 *5)	—	—	mA	3
			5.0V ≤ V _{OUT(S)} ≤ 6.0V	300 *5)	—	—	mA	3
Dropout voltage *3)	V _{drop}	I _{OUT} = 60mA	2.0V ≤ V _{OUT(S)} ≤ 2.4V	—	0.51	0.87	V	1
			2.5V ≤ V _{OUT(S)} ≤ 2.9V	—	0.38	0.61	V	1
			3.0V ≤ V _{OUT(S)} ≤ 3.4V	—	0.30	0.44	V	1
			3.5V ≤ V _{OUT(S)} ≤ 3.9V	—	0.24	0.33	V	1
			4.0V ≤ V _{OUT(S)} ≤ 4.4V	—	0.20	0.26	V	1
			4.5V ≤ V _{OUT(S)} ≤ 4.9V	—	0.18	0.22	V	1
			5.0V ≤ V _{OUT(S)} ≤ 5.4V	—	0.17	0.21	V	1
		5.5V ≤ V _{OUT(S)} ≤ 6.0V	—	0.17	0.20	V	1	
Line regulation 1	$\frac{\Delta V_{OUT1}}{\Delta V_{IN} \cdot V_{OUT}}$	V _{OUT(S)} + 0.5 V ≤ V _{IN} ≤ 10 V, I _{OUT} = 30mA	—	0.05	0.2	%/V	1	
Line regulation 2	$\frac{\Delta V_{OUT2}}{\Delta V_{IN} \cdot V_{OUT}}$	V _{OUT(S)} + 0.5 V ≤ V _{IN} ≤ 10 V, I _{OUT} = 10μA	—	0.05	0.2	%/V	1	
Load regulation	ΔV _{OUT3}	V _{IN} = V _{OUT(S)} + 1 V, 10μA ≤ I _{OUT} ≤ 80mA	—	30	50	mV	1	
Output voltage temperature coefficient *4)	$\frac{\Delta V_{OUT}}{\Delta T_a \cdot V_{OUT}}$	V _{IN} = V _{OUT(S)} + 1 V, I _{OUT} = 30mA -40°C ≤ T _a ≤ 85°C	—	±100	—	ppm/°C	1	
Current consumption during operation	I _{SS1}	V _{IN} = V _{OUT(S)} + 1 V, ON/OFF pin = ON, no load	—	30	40	μA	2	
Current consumption when power off	I _{SS2}	V _{IN} = V _{OUT(S)} + 1 V, ON/OFF pin = OFF, no load	—	0.1	0.5	μA	2	
Input voltage	V _{IN}		—	—	10	V	1	
Power-off pin input voltage "H"	V _{SH}	V _{IN} = V _{OUT(S)} + 1 V, R _L = 1kΩ, Judged by V _{OUT} output level.	1.5	—	—	V	4	
Power-off pin input voltage "L"	V _{SL}	V _{IN} = V _{OUT(S)} + 1 V, R _L = 1kΩ, Judged by V _{OUT} output level.	—	—	0.3	V	4	
Power-off pin input current "H"	I _{SH}	V _{IN} = V _{OUT(S)} + 1 V, ON/OFF = 7 V	—	—	0.1	μA	4	
Power-off pin input current "L"	I _{SL}	V _{IN} = V _{OUT(S)} + 1 V, ON/OFF = 0 V	—	—	-0.1	μA	4	
Ripple rejection	RR	V _{IN} = V _{OUT(S)} + 1 V, f = 100Hz, ΔV _{rip} = 0.5 V p-p, I _{OUT} =30mA	—	45	—	dB	5	

*1) V_{OUT(S)}=Specified output voltage

V_{OUT(E)}=Effective output voltage, i.e., the output voltage at fixet I_{OUT}(=30 mA) and input V_{OUT(S)}+1.0 V.

*2) Output current when the output voltage goes below 95% of V_{OUT(E)} after gradually increasing output current.

*3) V_{drop} = V_{IN1}-(V_{OUT(E)} × 0.98)

V_{IN1} = Input voltage when output voltage falls 98% of V_{OUT(E)} after gradually decreasing input voltage.

*4) Output voltage shift by temperature [mV/°C] is calculated using the following equation.

$$\frac{\Delta V_{OUT}}{\Delta T_a} [\text{mV}/^\circ\text{C}] = V_{OUT(S)} [\text{V}] \times \frac{\Delta V_{OUT}}{\Delta T_a \cdot V_{OUT}} [\text{ppm}/^\circ\text{C}] \div 1000$$

↑
↑
↑

Output voltage shift by temperature Specified output voltage Output voltage temperature coefficient

*5) Peak output current can exceed the minimum value.

■ Test Circuits

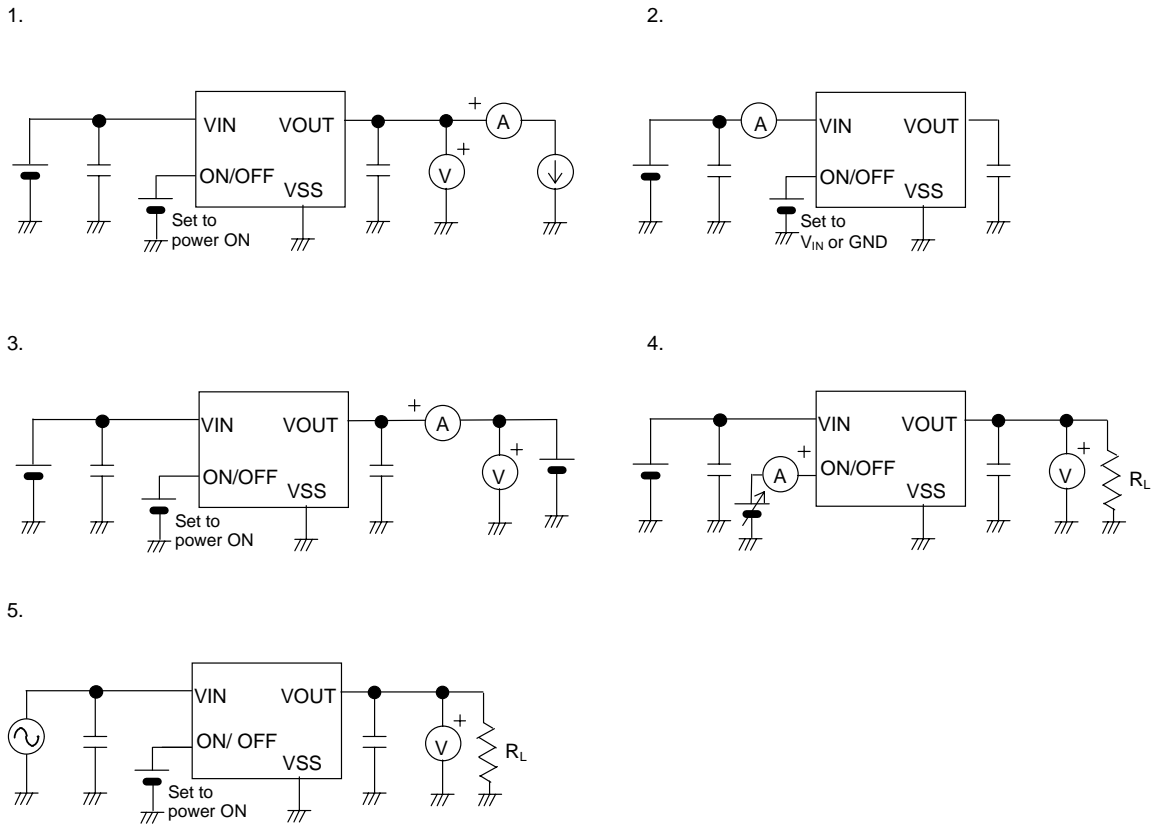

Figure 4 Test Circuits

■ Standard Circuit

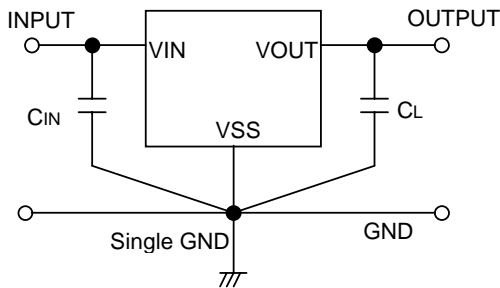

Figure 5 Standard Circuit

In addition to a tantalum capacitor, a ceramic capacitor of 2 μF or more can be used in CL. CIN is a capacitor used to stabilize input. Use a capacitor of 0.47 μF or more.

■ Operating Conditions

- Input capacitor (C_{IN}) : 0.47 μF or more
- Output capacitor (C_L) : 2 μF or more
- Equivalent Series Resistor (ESR) : 10 Ω or less
- Input Series Resistor (R_{IN}) : 10 Ω or less

■ Technical Terms

1. Low dropout voltage regulator

The low dropout voltage regulator is a voltage regulator having a low dropout voltage characteristic due to the internal low on-resistance transistor.

2. Output voltage (V_{OUT})

The accuracy of the output voltage is ensured at ± 2.0% under the specified conditions of input voltage, output current, and temperature, which differ product by product.

Note:

When the above conditions are changed, the output voltage may vary and go out of the accuracy range of the output voltage. See the electrical characteristics and characteristic data for details.

3. Line regulations 1 and 2 (ΔV_{OUT1}, ΔV_{OUT2})

Line regulation indicates the input voltage dependence of the output voltage. The value shows how much the output voltage changes due to the change of the input voltage when the output current is kept constant.

4. Load regulation (ΔV_{OUT3})

Load regulation indicates the output current dependence of output voltage. The value shows how much the output voltage changes due to the change of the output current when the input voltage is kept constant.

5. Dropout voltage (V_{drop})

Let V_{IN1} be an input voltage where the output voltage falls to the 98% of the actual output voltage V_{OUT(E)} when gradually decreasing input voltage. The dropout voltage is the difference between the V_{IN1} and the resultant output voltage defined as following equation.

$$V_{drop} = V_{IN1} - [V_{OUT(E)} \times 0.98]$$

6. Temperature coefficient of output voltage [ΔV_{OUT}/(ΔT_a • V_{OUT})]

The shadowed area in Figure 6 is the range where V_{OUT} varies in the operating temperature range when the temperature coefficient of the output voltage is ±100 ppm/°C.

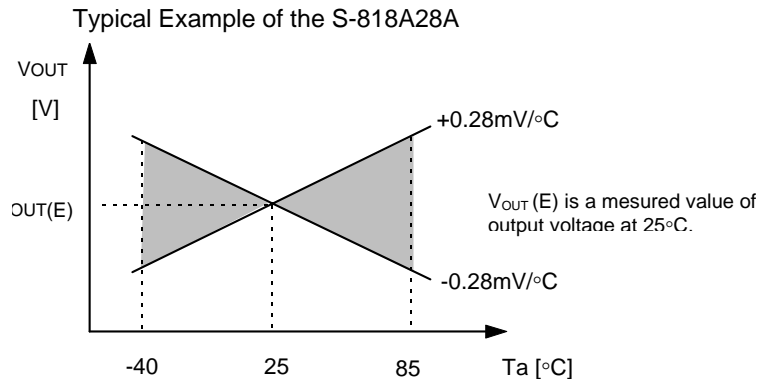

Figure 6 Temperature coefficient range of output voltage

A change of output voltage in temperature [mV/°C] is calculated using the following equation.

$$\frac{\Delta V_{OUT}}{\Delta T_a} [\text{mV}/^\circ\text{C}] = V_{OUT(S)} [\text{V}] \times \frac{\Delta V_{OUT}}{\Delta T_a \cdot V_{OUT}} [\text{ppm}/^\circ\text{C}] \div 1000$$

↑ Specified output voltage ↑ Output voltage temperature coefficient
 Change of output voltage in temperatures

■ Operation

1. Basic operation

Figure 7 shows the block diagram of the S-818 Series.

The error amplifier compares a reference voltage V_{REF} with the part of the output voltage divided by the feedback resistors R_s and R_f . It supplies the output transistor with the gate voltage, necessary to ensure certain output voltage free of any fluctuations of input voltage and temperature.

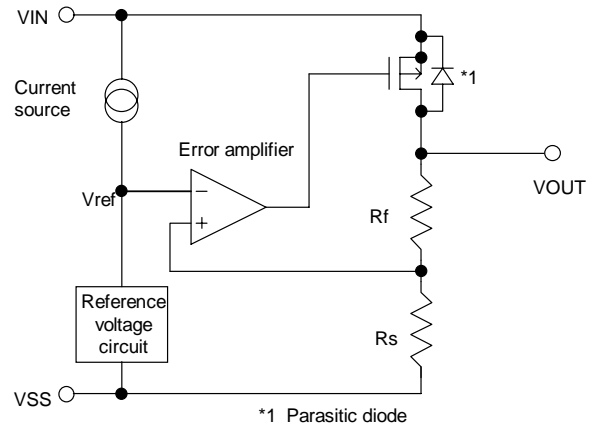

Figure 7 Typical Circuit Block Diagram

2. Output transistor

The S-818 Series uses a low on-resistance Pch MOS FET as the output transistor.

Be sure that V_{OUT} does not exceed $V_{IN}+0.3$ V to prevent the voltage regulator from being broken due to inverse current flowing from V_{OUT} pin to V_{IN} pin through the parasitic diode.

3. Power Off Pin (ON/OFF Pin)

This pin activates and inactivates the regulator.

When the ON/OFF pin is switched to the power off level, the operation of all internal circuit stops, the built-in Pch MOSFET output transistor between V_{IN} and V_{OUT} pin is switched off, suppressing current consumption. The V_{OUT} pin goes to the V_{SS} level due to internal divided resistance of several $M\Omega$ between V_{OUT} pin and V_{SS} pin.

The structure of the ON/OFF pin is shown in Figure 8. Since the ON/OFF pin is neither pulled down nor pulled up internally, do not keep it in the floating state. Current consumption increases if a voltage of 0.3 V to $V_{IN}-0.3$ V is applied to the ON/OFF pin. When the power off pin is not used, connect it to the V_{IN} pin for product type "A" and to the V_{SS} pin for product type "B".

Table 6 Power off pin function by product type

Product type	ON/OFF pin	Internal circuit	V_{OUT} pin voltage	Current consumption
A	"H" : Power on	Operating	Set value	I_{ss1}
A	"L" : Power off	Stop	V_{SS} level	I_{ss2}
B	"H" : Power off	Stop	V_{SS} level	I_{ss2}
B	"L" : Power on	Operating	Set value	I_{ss1}

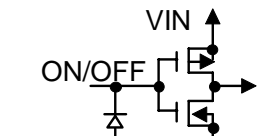

Figure 8 ON/OFF Pin

■ Selection of Output Capacitor (CL)

The S-818 series needs an output capacitor between VOUT pin and VSS pin for phase compensation. A small ceramic or an OS electrolytic capacitor of 2 μF or more can be used. If a tantalum or an aluminum electrolytic capacitor is used, its capacitance must be 2 μF or more and the ESR must be 10 Ω or less.

Attention should be paid not to cause an oscillation due to increase of ESR at low temperatures when using an aluminum electrolytic capacitor.

Evaluate the performance including temperature characteristics before prototyping the circuit.

Overshoot and undershoot characteristics differ depending upon the type of the output capacitor. Refer to output capacitor dependence data in transient response characteristics .

■ Design Considerations

- Design wiring patterns for VIN, VOUT and GND pins to decrease impedance.
When mounting an output capacitor, connection from the capacitor to the VOUT pin and to the VSS pin should be as close as possible.
- Note that output voltage may increase when the voltage regulator is used at low load current (less than 10 μA).
- To prevent oscillation, it is recommended to use the external components under the following conditions:
 - * Input capacitor (CIN): 0.47 μF or more
 - * Output capacitor (CL): 2 μF or more
 - * Equivalent Series Resistance (ESR): 10 Ω or less
 - * Input series resistance (RIN): 10 Ω or less
- The voltage regulator may oscillate when the impedance of the power supply is high and the input capacitor is small or not connected.
- Be sure that input voltage and load current do not exceed the power dissipation level of the package.
- SII claims no responsibility for any and all disputes arising out of or in connection with any infringement of the products including this IC upon patents owned by a third party.
- In determining necessary output current, consider the value of output current of Table 4 "Electrical Characteristics" and Note *5) (page 4).

■ Typical Characteristics (Typical Data)

(1) OUTPUT VOLTAGE vs. OUTPUT CURRENT (When load current increases)

S-818A20A (Ta=25°C)

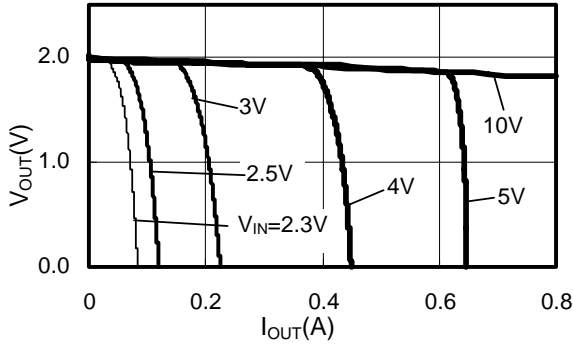

S-818A30A (Ta=25°C)

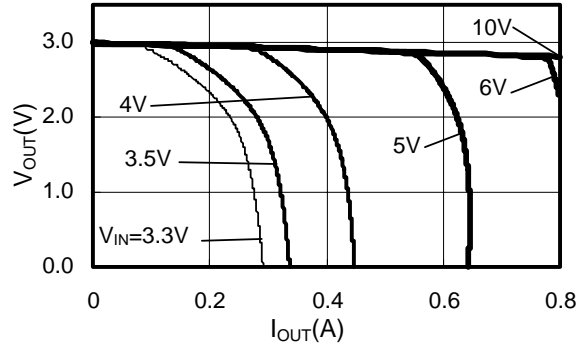

S-818A50A (Ta=25°C)

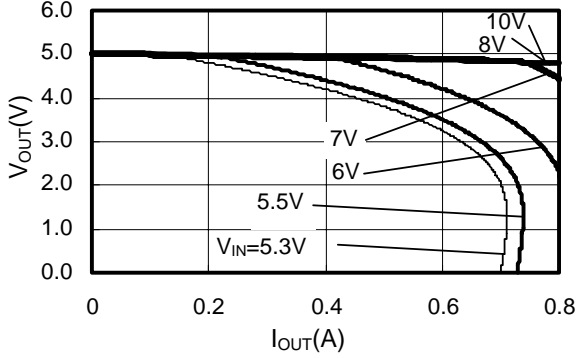

* In determining necessary output current, consider the following parameters:

- Minimum value of output current in Table 4 "Electrical Characteristics" and Note *5) (page 4);
- Power dissipation of the package

(2) OUTPUT VOLTAGE vs. INPUT VOLTAGE

S-818A20A (Ta=25°C)

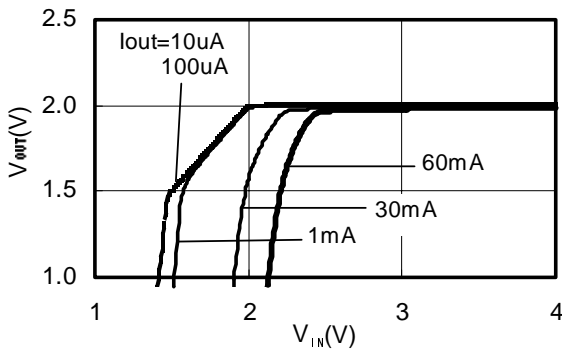

S-818A30A (Ta=25°C)

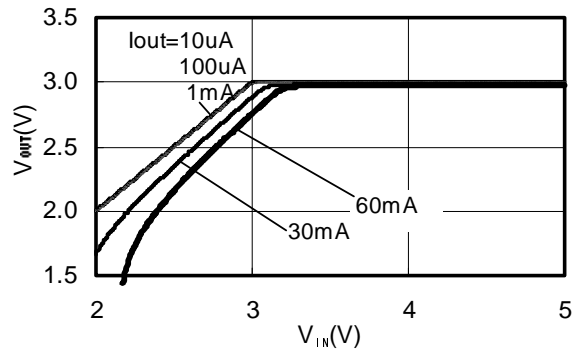

S-818A50A (Ta=25°C)

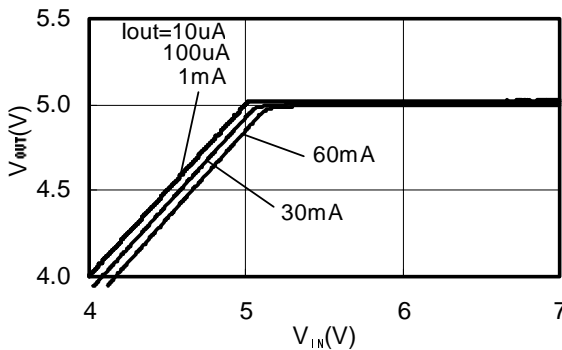

(3) MAXIMUM OUTPUT CURRENT vs. INPUT VOLTAGE

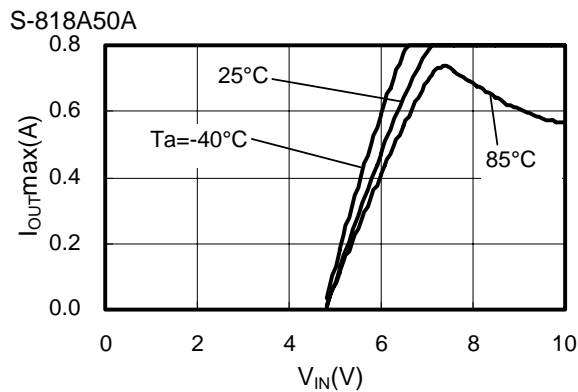
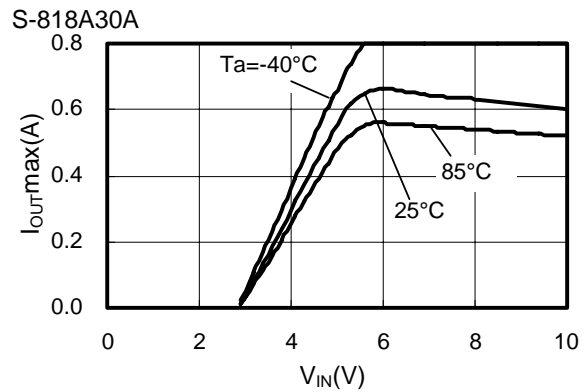
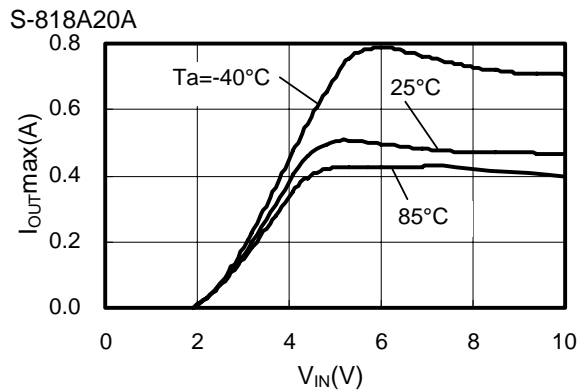

- * In determining necessary output current, consider the following parameters:
- Minimum value of output current in Table 4 "Electrical Characteristics" and Note *5) (page 4);
 - Power dissipation of the package

(4) DROPOUT VOLTAGE vs. OUTPUT CURRENT

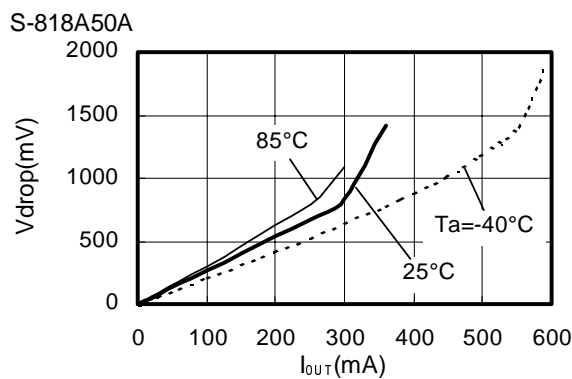
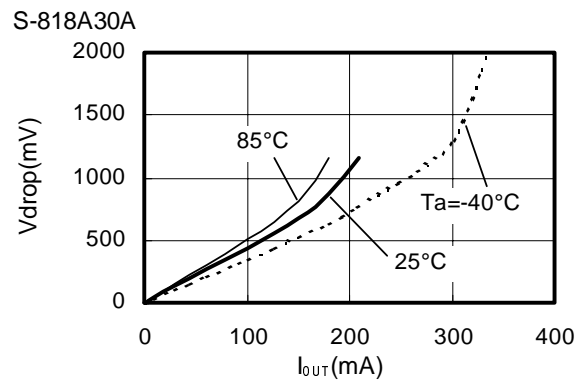
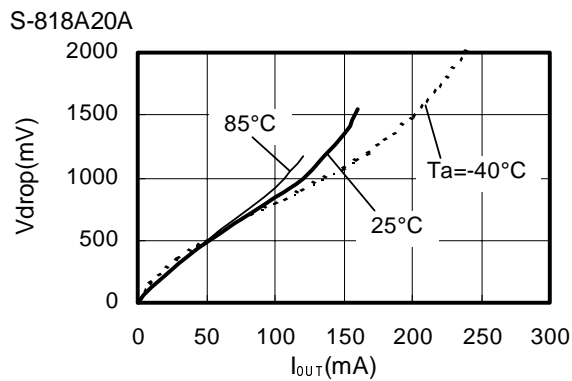

(5) OUTPUT VOLTAGE TEMPERATURE DEPENDENCE

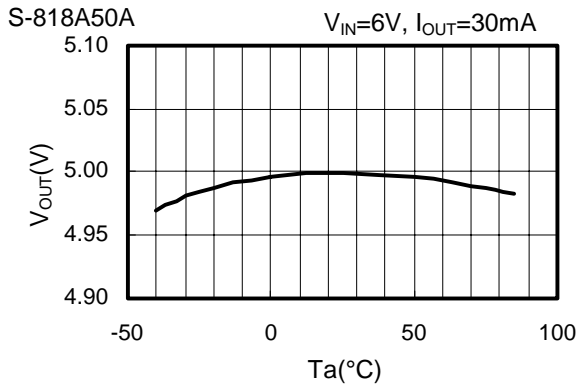
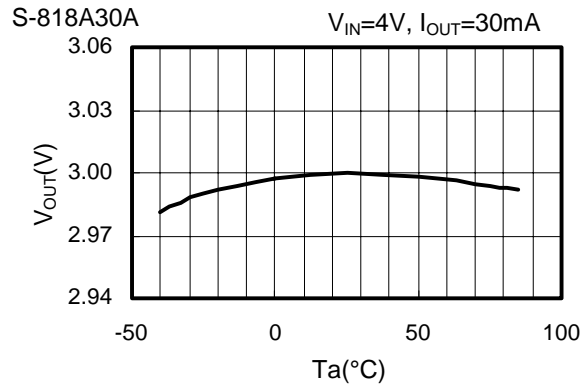
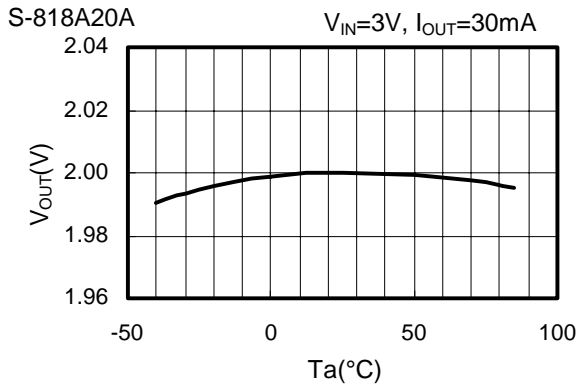

(6) LINE REGULATION TEMPERATURE DEPENDENCE

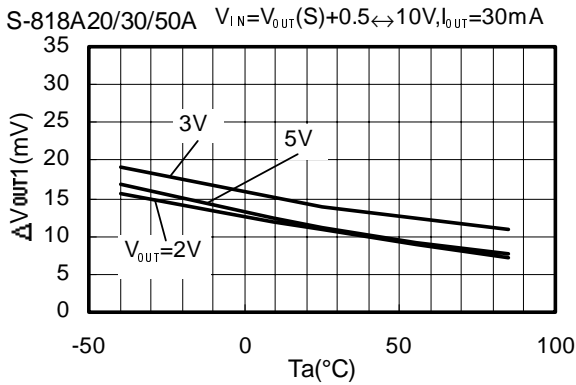

(7) LOAD REGULATION TEMPERATURE DEPENDENCE

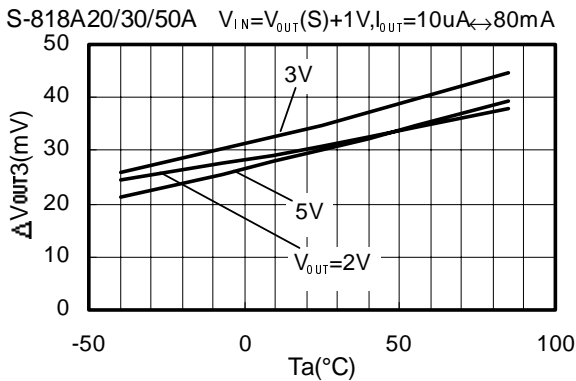

(8) CURRENT CONSUMPTION vs. INPUT VOLTAGE

S-818A20A

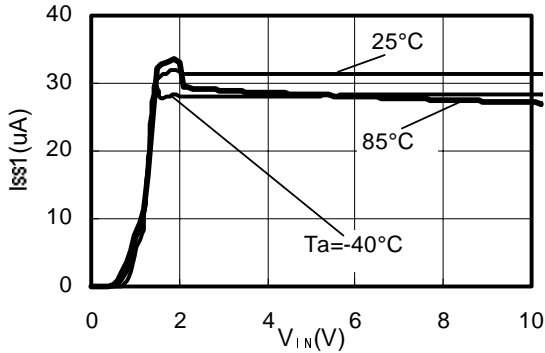

S-818A30A

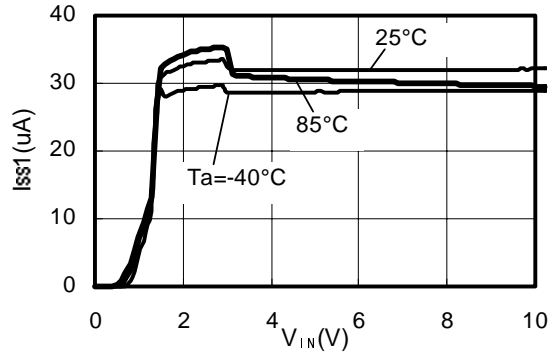

S-818A50A

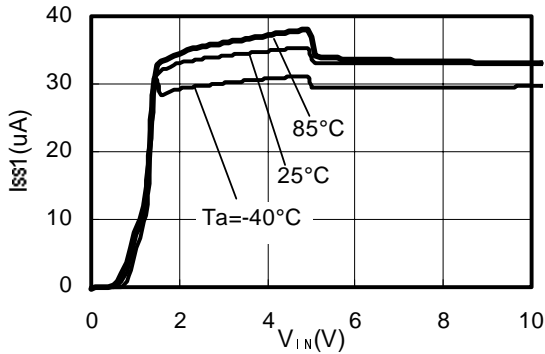

(9) THRESHOLD VOLTAGE OF POWER OFF PIN vs. INPUT VOLTAGE

S-818A20A

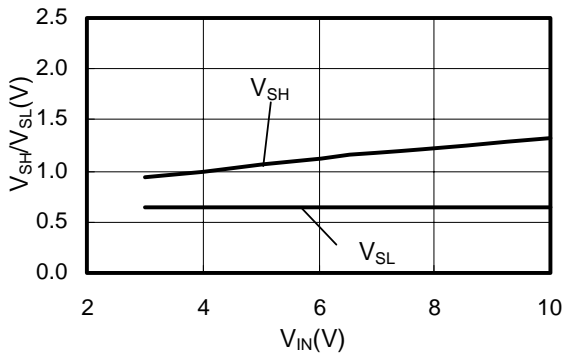

S-818A30A

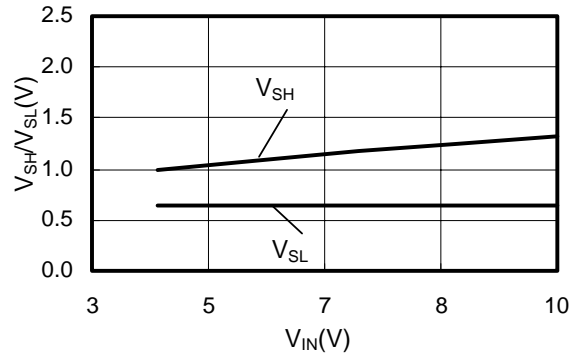

S-818A50A

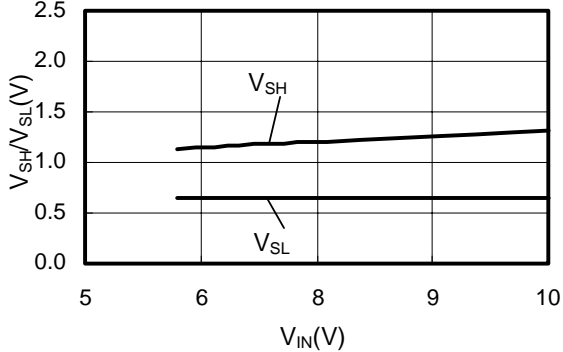

(10) RIPPLE REDUCTION RATE

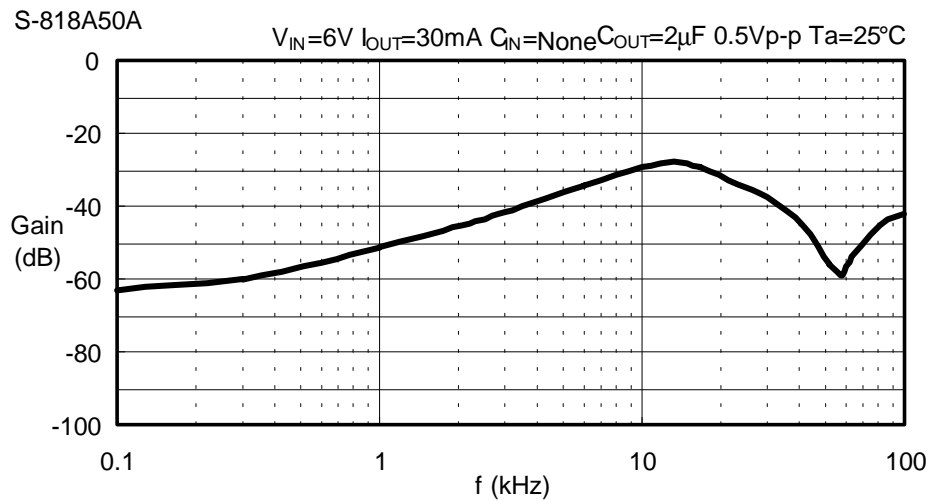
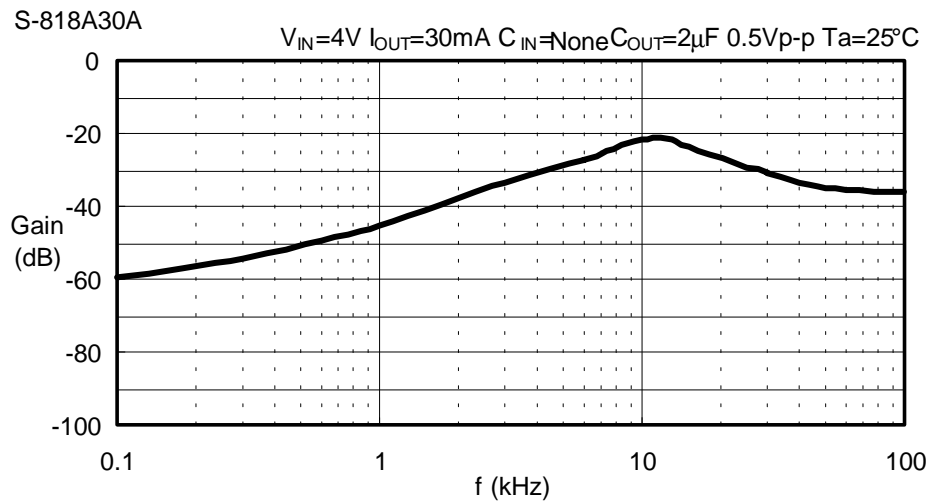
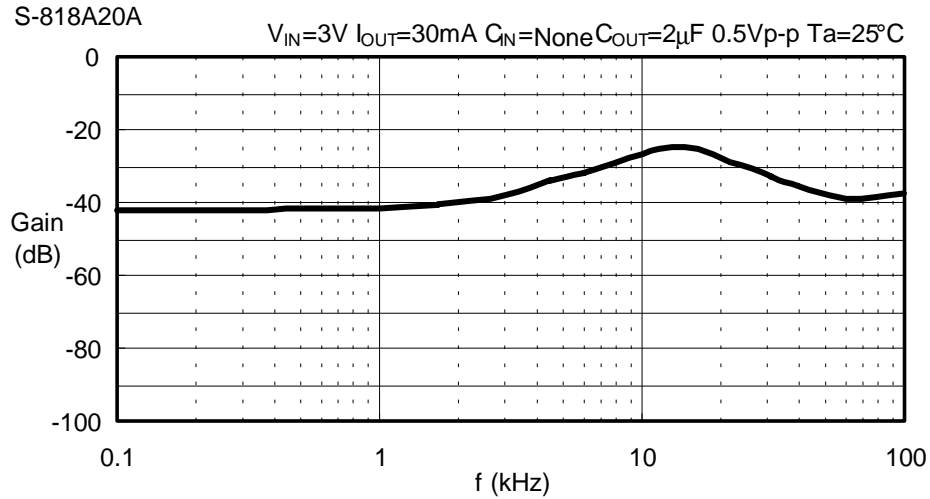

TRANSIENT RESPONSE CHARACTERISTICS (S-818A30A, Typical data: $T_a=25^\circ\text{C}$)

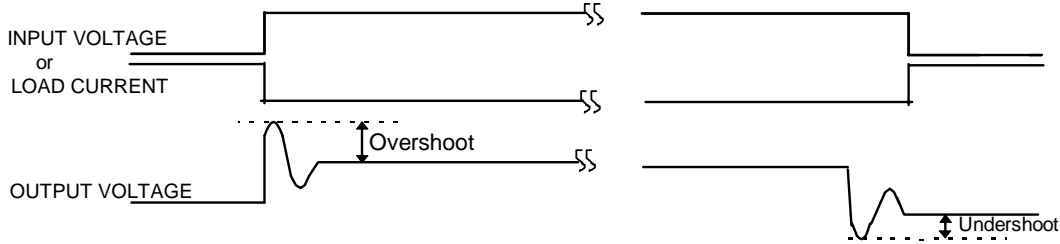

(1) Power on

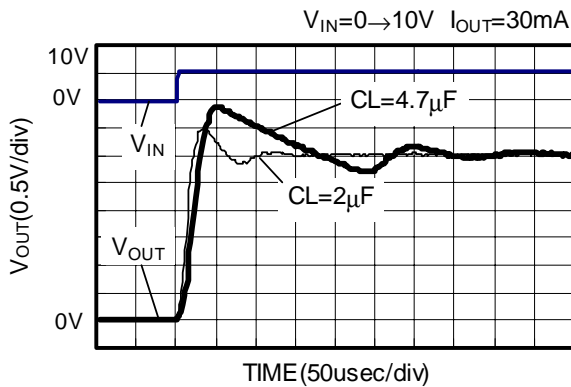

Load dependence of overshoot

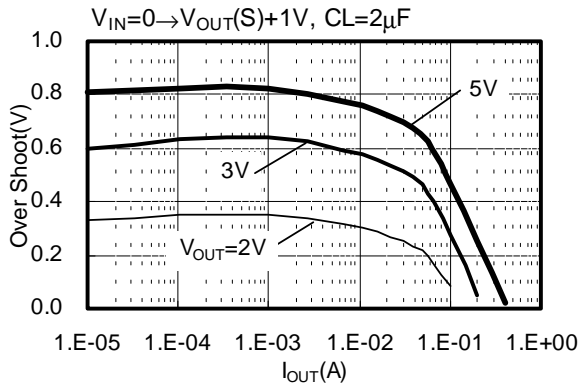

Output capacitor (CL) dependence of overshoot

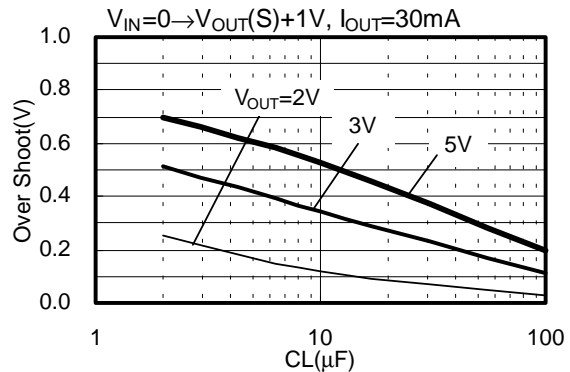

VDD dependence of overshoot

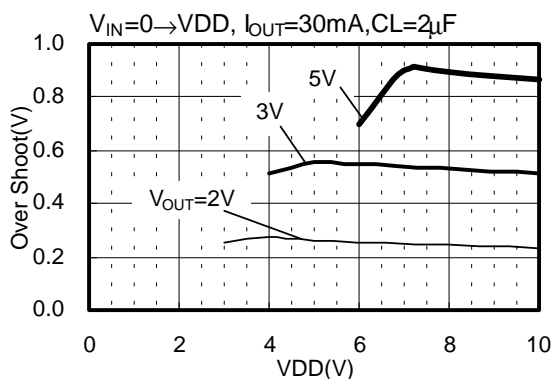

Temperature dependence of overshoot

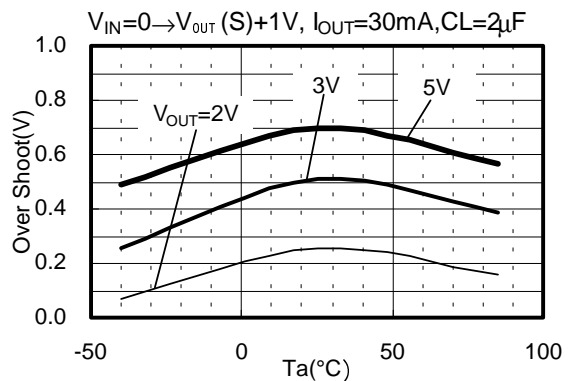

(2) Power on/off control

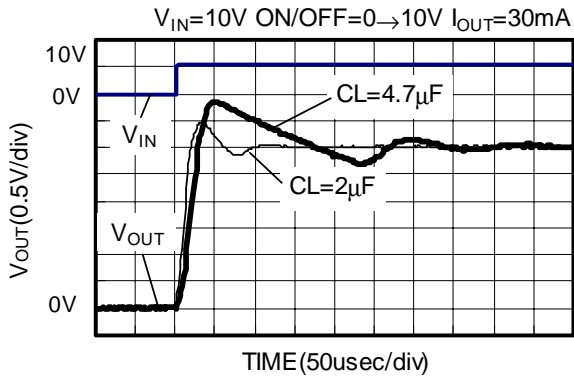

Load dependence of overshoot

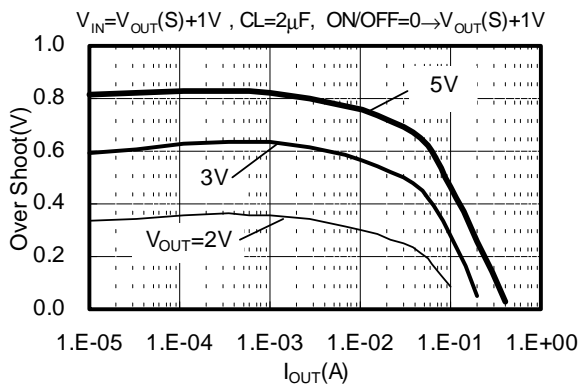

Output capacitor (CL) dependence of overshoot

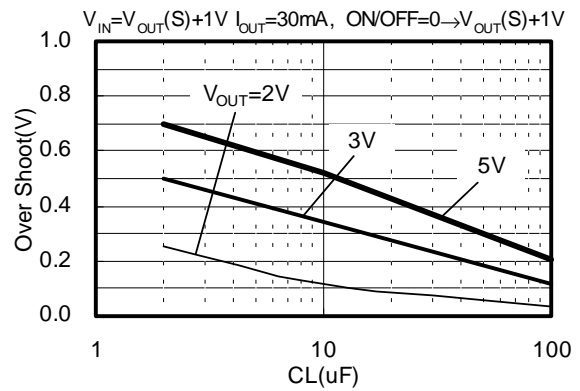

VDD dependence of overshoot

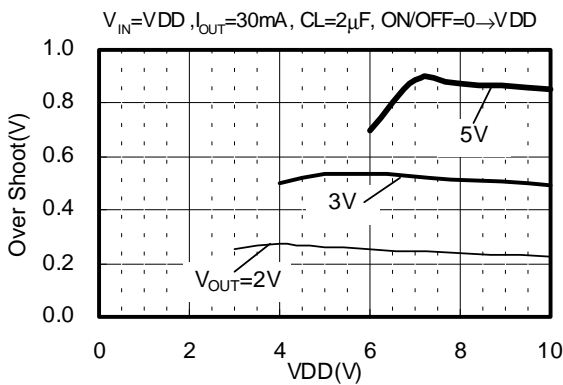

Temperature dependence of overshoot

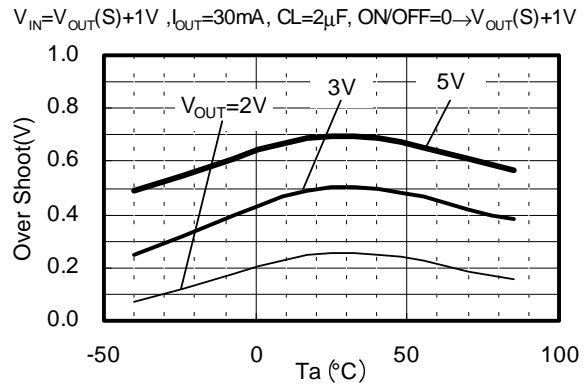

(3) Power fluctuation

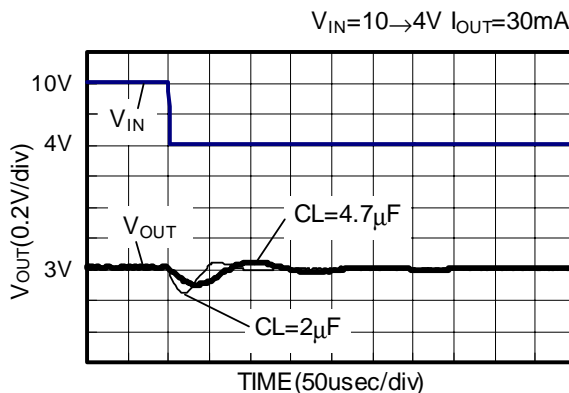
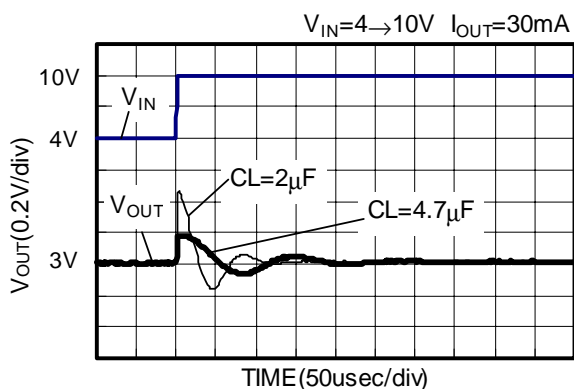

Load dependence of overshoot

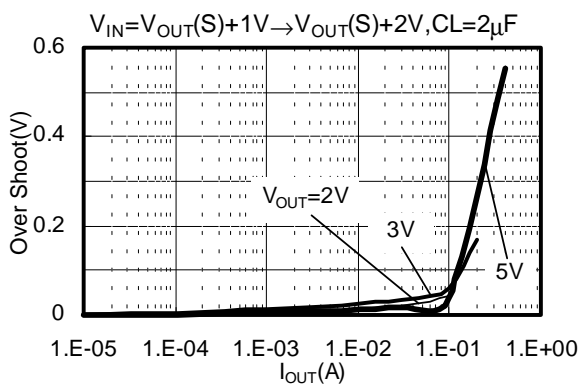

Output capacitor (CL) dependence of overshoot

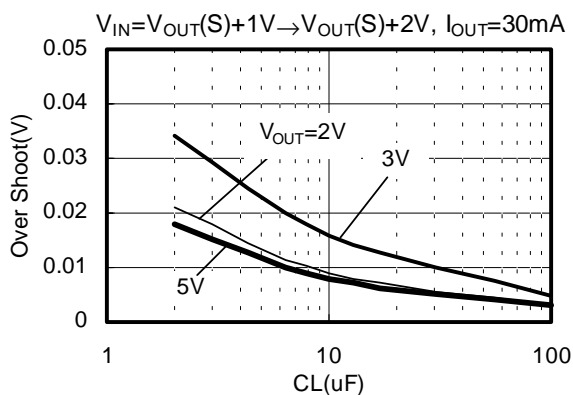

VDD dependence of overshoot

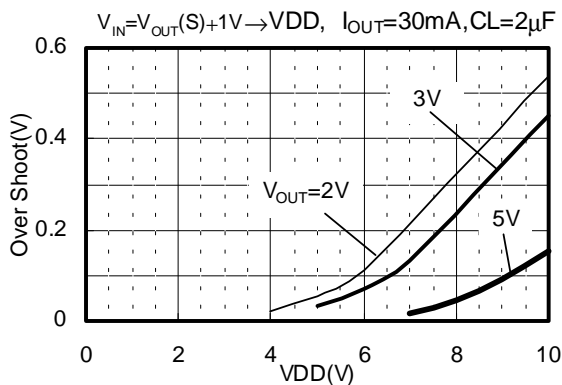

Temperature dependence of overshoot

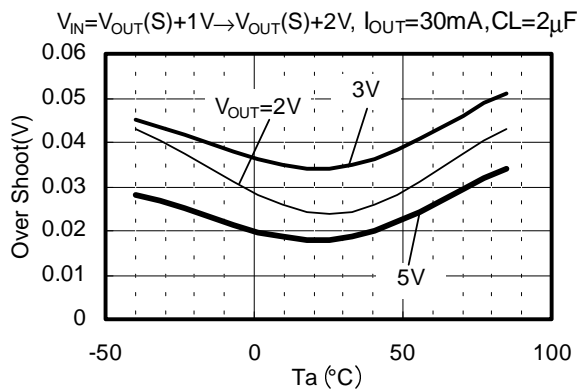

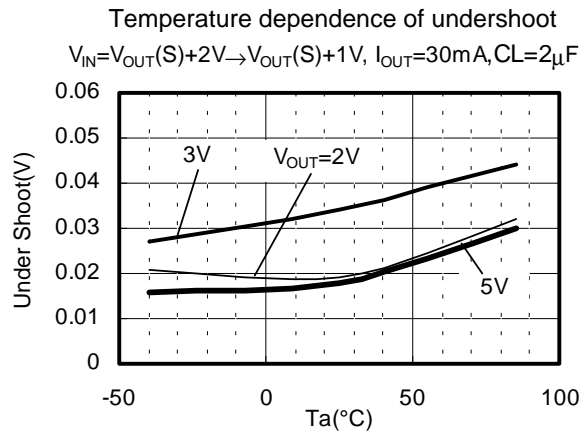
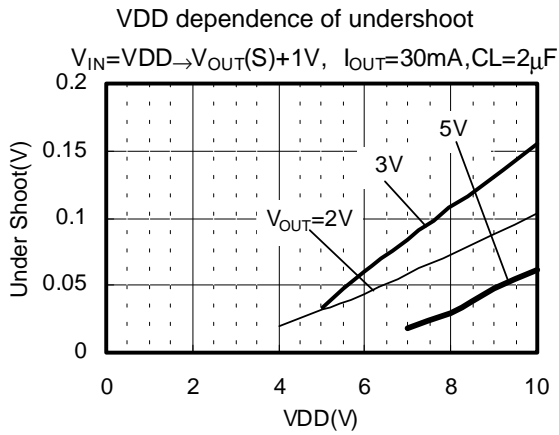
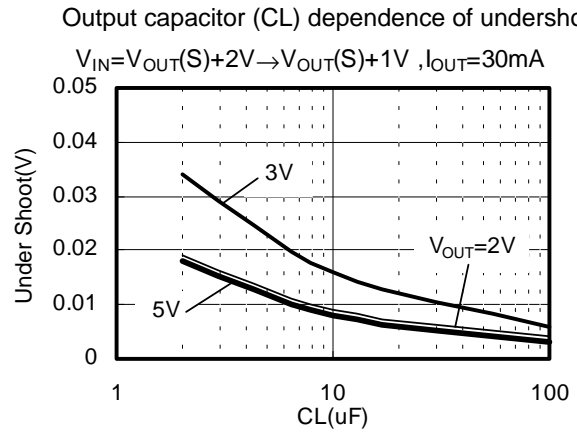
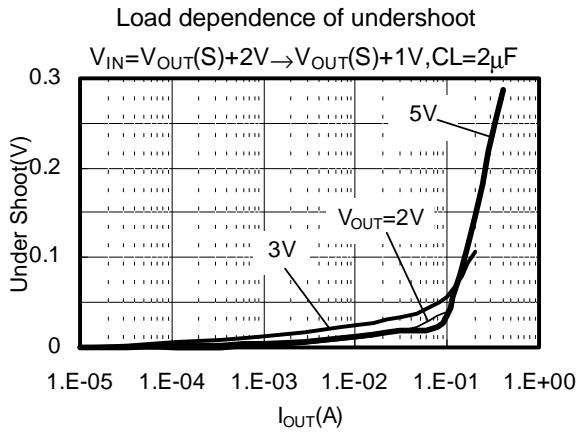

(4) Load fluctuation

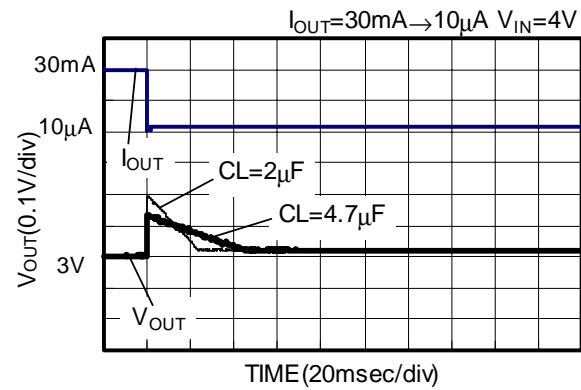
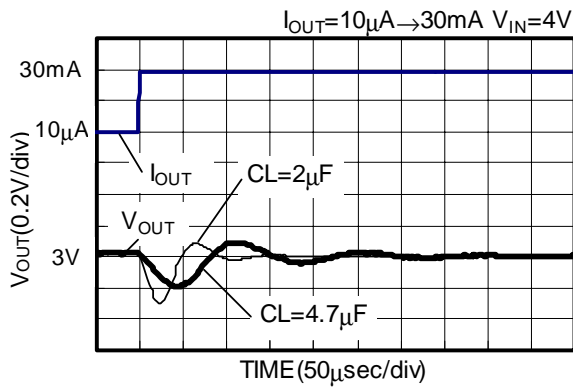

Load current dependence of load fluctuation overshoot

ΔI_{OUT} shows larger load current at load current fluctuation while smaller current is fixed to 10 μ A. For example $\Delta I_{OUT}=1.E-02$ (A) means load current fluctuation from 10 mA to 10 μ A.

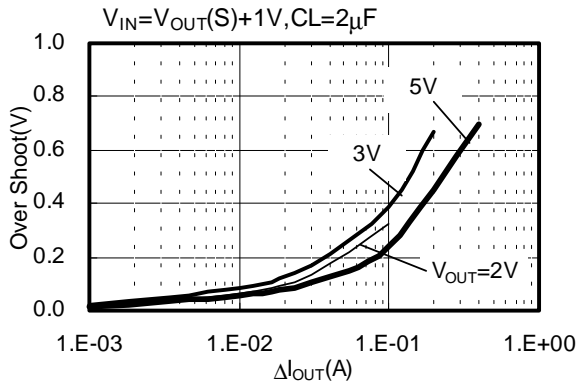

Output capacitor (CL) dependence of overshoot

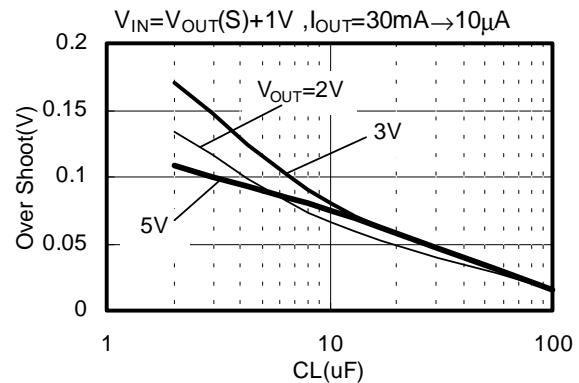

VDD dependence of overshoot

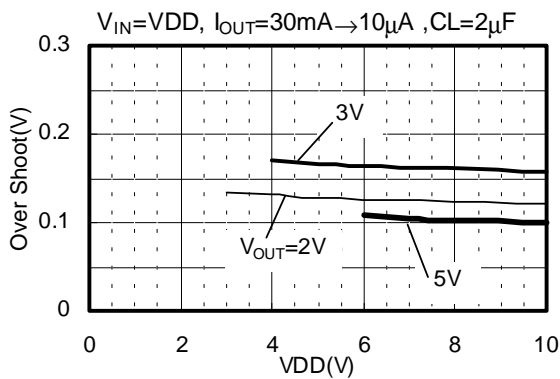

Temperature dependence of overshoot

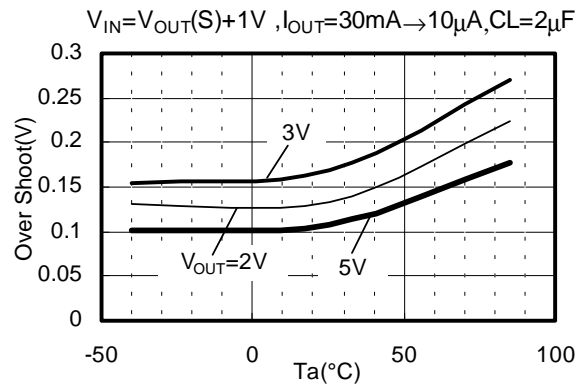

Load current dependence of load fluctuation undershoot

ΔI_{OUT} shows larger load current at load current fluctuation while smaller current is fixed to $10\ \mu\text{A}$. For example $\Delta I_{OUT}=1.E-02$ (A) means load current fluctuation from $10\ \mu\text{A}$ to $10\ \text{mA}$.

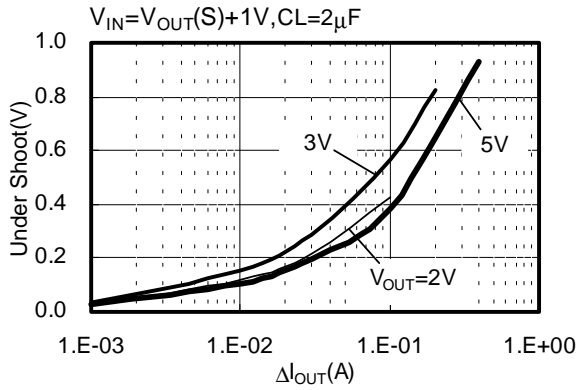

Output capacitor (CL) dependence of undershoot

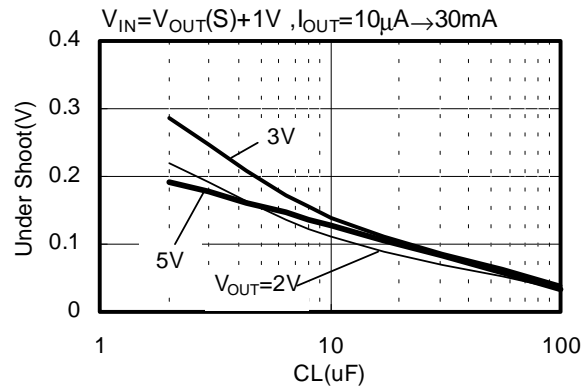

VDD dependence of undershoot

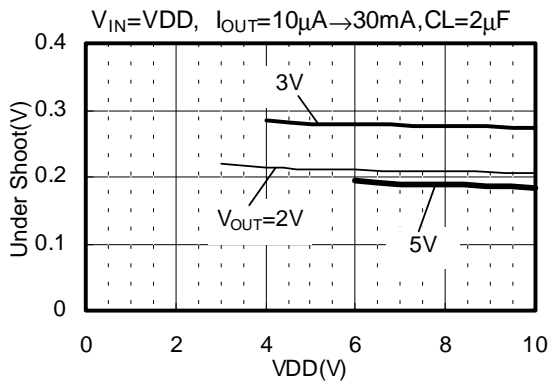

Temperature dependence of undershoot

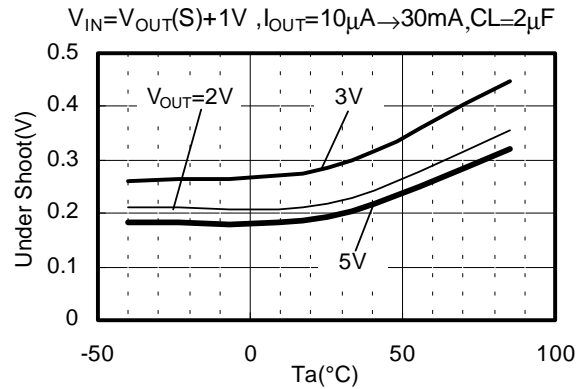

■ SOT-23-5

MP005-A 991105

● Dimensions 外形図

Unit : mm

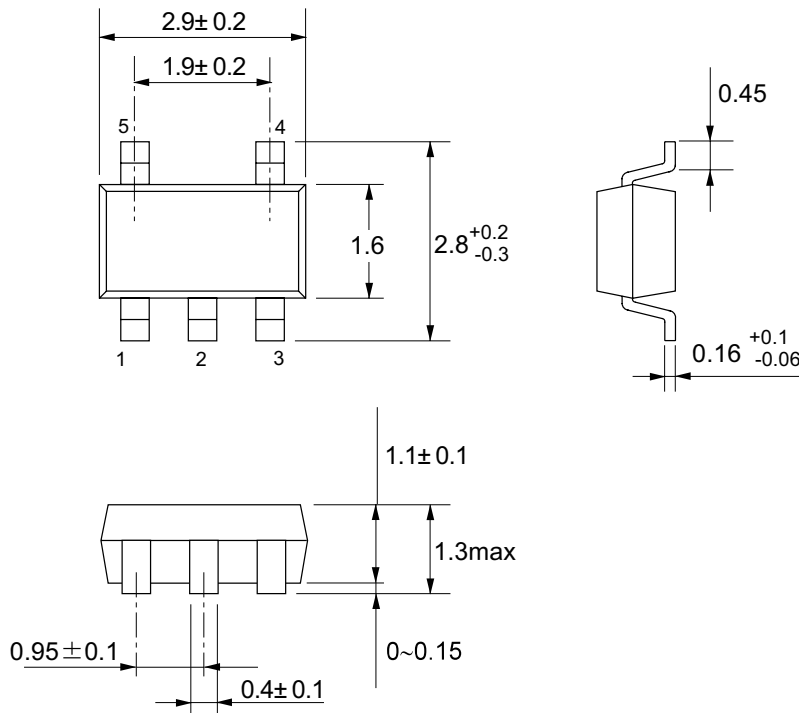

No. : MP005-A-P-SD-1.1

● Taping Specifications テーピング図

● Reel Specifications リール図

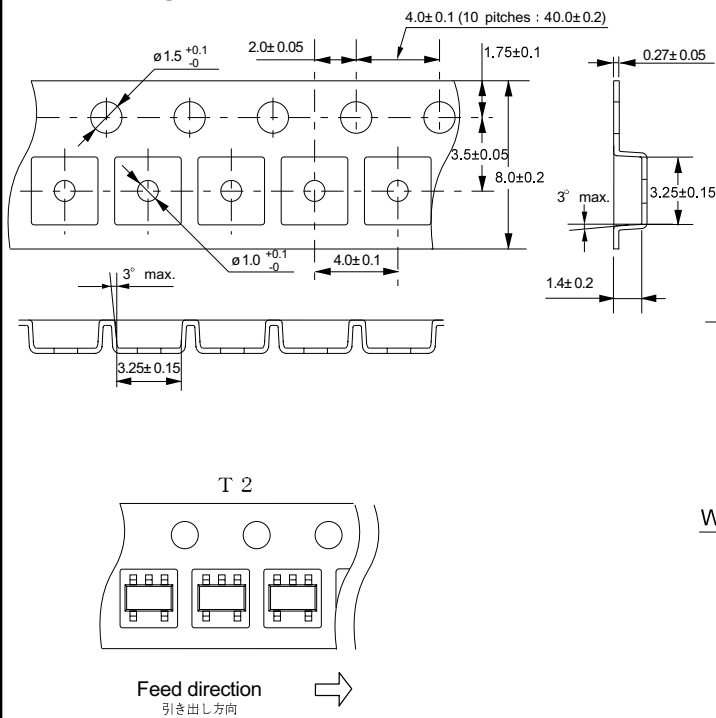

3000 pcs./reel

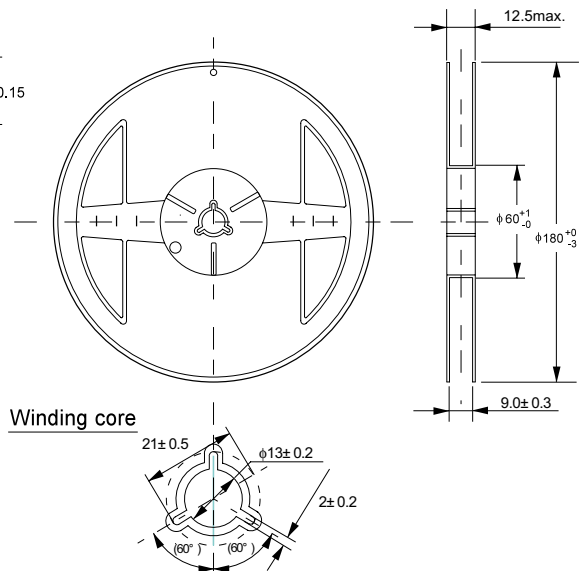

No. : MP005-A-R-SD-1.0

No. : MP005-A-C-SD-1.0

● SOT-23-5

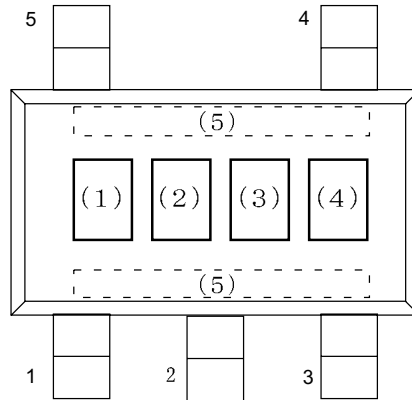

(1) to (3) : Product name (abbreviation)

(4) : Month of assembly

(5) : Dot on one side (Year and week of assembly)

No. : MP 0 0 5 - A - M - S 1 - 1 . 0

● SOT-89-5

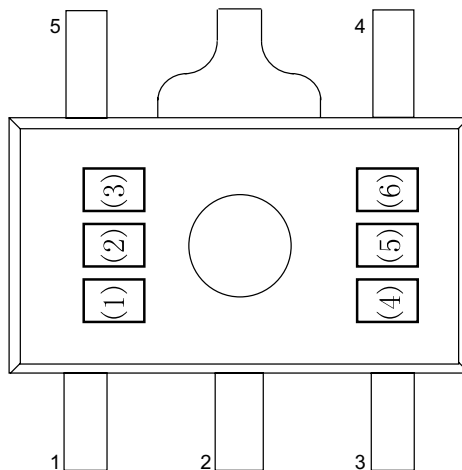

(1) to (3) : Product name (abbreviation)

(4) : Year of assembly

(5) : Month of assembly

(6) : Week of assembly

No. : UP 0 0 5 - A - M - S 1 - 1 . 0

- The information herein is subject to change without notice.
- Seiko Instruments Inc. is not responsible for any problems caused by circuits or other diagrams described herein whose industrial properties, patents or other rights belong to third parties. The application circuit examples explain typical applications of the products, and do not guarantee any mass-production design.
- When the products described herein include Strategic Products (or Service) subject to regulations, they should not be exported without authorization from the appropriate governmental authorities.
- The products described herein cannot be used as part of any device or equipment which influences the human body, such as physical exercise equipment, medical equipment, security system, gas equipment, vehicle or airplane, without prior written permission of Seiko Instruments Inc.