

# FAN256 — Dual Low Voltage Comparator

## Features

- Low Supply Current:  $I_{DD}=7\mu A$  (Typical)
- Single Power Supply Operation
- Wide Common-Mode Input Voltage Range: Rail-to-Rail
- Push-Pull Output Circuit
- Low Input Bias Current
- Internal Hysteresis
- Packaged in MicroPak™ 8 (1.6mm x 1.6mm)

## Applications

- Mobile Phones
- Alarm and Security Systems
- Personal Digital Assistants

## Description

The FAN256 is a low-power, dual comparator that typically consumes less than  $10\mu A$  supply current per comparator. Guaranteed to operate at a low voltage of 1.6V and fully operational up to 5.5V, it is convenient for use in 1.8, 3.0V, and 5.0V systems.

The FAN256 has a complementary push-pull P- and N-channel output stage capable of driving a rail-to-rail output swing with a load ranging up to 5.0mA.

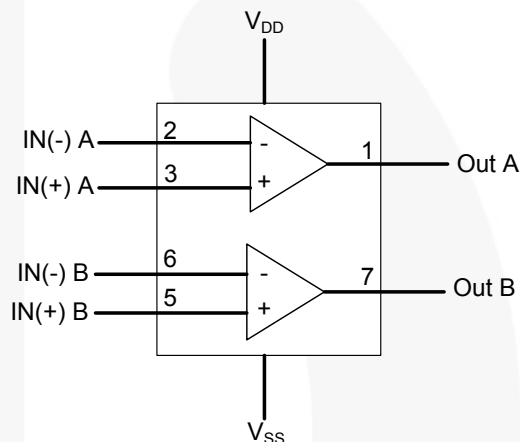

Figure 1. Functional Diagram

## Ordering Information

Part Number	Top Mark	Operating Temperature Range	Package	Packing Method
FAN256L8X	CP	-40 to 85°C	8-Lead, MicroPak™ 1.6mm x 1.6mm Package	5000 Units on Tape and Reel

### Pin Configuration

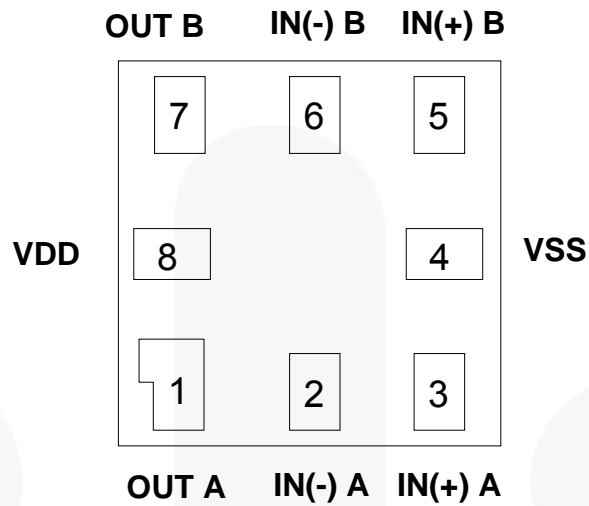

Figure 2. Pin Configuration (Top Through View)

### Pin Definitions

Pin #	Name	Description
1	OUT A	Comparator A Output
2	IN(-) A	Inverting Input of Comparator A
3	IN(+) A	Non-Inverting Input of Comparator A
4	VSS	Negative Supply Voltage
5	IN(+) B	Non-Inverting Input of Comparator B
6	IN(-) B	Inverting Input of Comparator B
7	OUT B	Comparator B Output
8	VDD	Positive Supply Voltage

### Function Table

Inputs	Outputs
$IN(-) > IN(+)$	Output LOW
$IN(+ > IN(-)$	Output HIGH

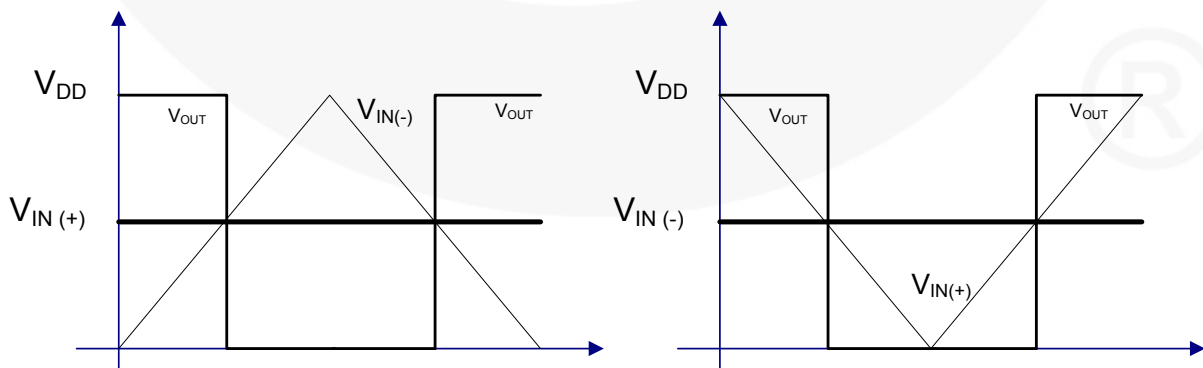

Figure 3.  $V_{IN}$  vs.  $V_{OUT}$

## Absolute Maximum Ratings

Stresses exceeding the absolute maximum ratings may damage the device. The device may not function or be operable above the recommended operating conditions and stressing the parts to these levels is not recommended. In addition, extended exposure to stresses above the recommended operating conditions may affect device reliability. The absolute maximum ratings are stress ratings only.

Symbol	Parameter	Condition	Min.	Max.	Unit
$V_{DD}$ to $V_{SS}$	Supply Voltage		-3.0	+3.0	V
			0	6.0	
$DV_{IN}$	Differential Input Voltage			$\pm 6$	
$V_{IN}$	Input Voltage			$V_{SS}$ to $V_{DD}$	V
$t_s$	Output Short Circuit Duration <sup>(1)</sup>			Indefinite	S
$T_J$	Junction Temperature			+150	°C
$T_{STG}$	Storage Temperature Range		-65	+150	°C
$P_D$	Power Dissipation			226	mW
$\Theta_{JA}$	Thermal Resistance			287	°C/W
ESD	IEC 61000-4-2 System ESD	Air Gap		15	kV
		Contact		8	
	JEDEC JESD22-A114, Human Body Model	All Pins		8	
		Pin to Pin: IN(-), IN(+) to $V_{DD}$ or $V_{SS}$		12	
JEDEC JESD22-C101, Charged Device Model	All Pins		2		

### Note:

- The maximum total power dissipation must not be exceeded.

## Recommended Operating Conditions

The Recommended Operating Conditions table defines the conditions for actual device operation. Recommended operating conditions are specified to ensure optimal performance to the datasheet specifications. Fairchild does not recommend exceeding them or designing to Absolute Maximum Ratings.

Symbol	Parameter	Condition	Min.	Max.	Unit
$V_{DD}$ to $V_{SS}$	Power Supply		-2.75	+2.75	V
			0	5.5	
$V_{DD}$	Power Supply	$V_{SS}=0V$	1.6	5.5	V
$V_{IN}$	Input Voltage			$V_{SS}$ to $V_{DD}$	V
$I_{OH}/I_{OL}$	Output Sink/Source Current	$V_{DD}=5.0V$		5	mA
		$V_{DD}=3.0V$		3	
		$V_{DD}=1.6V$		1	
$T_A$	Operating Temperature, Free Air		-40	+85	°C

## Electrical Characteristics

Symbol	Parameter	Condition	Min.	Typ.	Max.	Unit
<b>V<sub>DD</sub>=5.5V, V<sub>SS</sub>=GND, and T<sub>A</sub>=+25°C</b>						
V <sub>HYS</sub>	Input Hysteresis	V <sub>CM</sub> =0.5V <sub>DD</sub>		4		mV
V <sub>IO</sub>	Input Offset Voltage <sup>(2)</sup>	V <sub>CM</sub> =0.5V <sub>DD</sub>	-15	±1	+15	mV
I <sub>IO</sub>	Input Offset Current			10		pA
I <sub>I</sub>	Input Bias Current			10		pA
V <sub>CM</sub>	Common Mode Input Voltage		V <sub>SS</sub>		V <sub>DD</sub>	V
CMRR	Common Mode Rejection Ratio <sup>(3)</sup>	V <sub>CM</sub> =V <sub>DD</sub>		68		dB
I <sub>DD</sub>	Supply Current - Per Comparator			7	17	µA
PSRR	Power Supply Rejection Ratio <sup>(3)</sup>	ΔV <sub>DD</sub> =0.5V	45	80		dB
I <sub>OS</sub>	Output Short Circuit Current	V <sub>O</sub> =V <sub>DD</sub>		60		mA
		V <sub>O</sub> =V <sub>SS</sub>		90		
V <sub>OL</sub>	Low-Level Output Voltage	I <sub>SINK</sub> =5.0mA		0.1	0.3	V
V <sub>OH</sub>	High-Level Output Voltage	I <sub>SOURCE</sub> =5.0mA	5.2	5.4		V
t <sub>PLH</sub>	Propagation Delay (Turn-On)	Overdrive=20mV, C <sub>L</sub> =15pF		0.40		µs
t <sub>PHL</sub>	Propagation Delay (Turn-Off)	Overdrive=20mV, C <sub>L</sub> =15pF		0.42		µs
t <sub>TLH</sub>	Response Time, Output Rise/Fall <sup>(4)</sup>	C <sub>L</sub> =50pF		4.0		ns
t <sub>THL</sub>				5.4		
<b>V<sub>DD</sub>=3V, V<sub>SS</sub>=GND, and T<sub>A</sub>=+25°C</b>						
V <sub>HYS</sub>	Input Hysteresis	V <sub>CM</sub> =0.5V <sub>DD</sub>		4		mV
V <sub>IO</sub>	Input Offset Voltage <sup>(2)</sup>	V <sub>CM</sub> =0.5V <sub>DD</sub>	-15	±1	+15	mV
I <sub>IO</sub>	Input Offset Current			10		pA
I <sub>I</sub>	Input Bias Current			10		pA
V <sub>CM</sub>	Common Mode Input Voltage		V <sub>SS</sub>		V <sub>DD</sub>	V
CMRR	Common Mode Rejection Ratio <sup>(3)</sup>	V <sub>CM</sub> =V <sub>DD</sub>		60		dB
I <sub>DD</sub>	Supply Current(x) Per Comparator			6	15	µA
PSRR	Power Supply Rejection Ratio <sup>(3)</sup>	ΔV <sub>DD</sub> =0.5V	45	70		dB
I <sub>OS</sub>	Output Short Circuit Current	V <sub>O</sub> =V <sub>DD</sub>		27		mA
		V <sub>O</sub> =V <sub>SS</sub>		35		
V <sub>OL</sub>	Low-Level Output Voltage	I <sub>SINK</sub> =3.0mA		0.15	0.35	V
V <sub>OH</sub>	High-Level Output Voltage	I <sub>SOURCE</sub> =3.0mA	2.65	2.85		V
t <sub>PLH</sub>	Propagation Delay (Turn-On)	Overdrive=20mV, C <sub>L</sub> =15pF		0.45		µs
t <sub>PHL</sub>	Propagation Delay (Turn-Off)	Overdrive=20mV, C <sub>L</sub> =15pF		0.47		µs
t <sub>TLH</sub>	Response Time, Output Rise/Fall <sup>(4)</sup>	C <sub>L</sub> =50pF		6.1		ns
t <sub>THL</sub>				6.2		

Continued on the following page...

## Electrical Characteristics

Symbol	Parameter	Condition	Min.	Typ.	Max.	Unit
<b>V<sub>DD</sub>=1.6V, V<sub>SS</sub>=GND, and T<sub>A</sub>=+25°C</b>						
V <sub>HYS</sub>	Input Hysteresis	V <sub>CM</sub> =0.5V <sub>DD</sub>		3.5		mV
V <sub>IO</sub>	Input Offset Voltage <sup>(2)</sup>	V <sub>CM</sub> =0.5V <sub>DD</sub>	-15	±1	+15	mV
I <sub>IO</sub>	Input Offset Current			10		pA
I <sub>I</sub>	Input Bias Current			10		pA
V <sub>CM</sub>	Common Mode Input Voltage		V <sub>SS</sub>		V <sub>DD</sub>	V
CMRR	Common Mode Rejection Ratio <sup>(3)</sup>	V <sub>CM</sub> =V <sub>DD</sub>		56		dB
I <sub>DD</sub>	Supply Current(x) Per Comparator			5	13	µA
PSRR	Power Supply Rejection Ratio <sup>(3)</sup>	ΔV <sub>DD</sub> =0.5V	45	70		dB
I <sub>OS</sub>	Output Short Circuit Current	V <sub>O</sub> =V <sub>DD</sub>		5.5		mA
		V <sub>O</sub> =V <sub>SS</sub>		7.5		
V <sub>OL</sub>	Low-Level Output Voltage	I <sub>SINK</sub> =1.0mA		0.15	0.25	V
V <sub>OH</sub>	High-Level Output Voltage	I <sub>SOURCE</sub> =1.0mA	1.35	1.50		V
t <sub>PLH</sub>	Propagation Delay (Turn-On)	Overdrive=20mV, C <sub>L</sub> =15pF		0.52		µs
t <sub>PHL</sub>	Propagation Delay (Turn-Off)	Overdrive=20mV, C <sub>L</sub> =15pF		0.54		µs
t <sub>TLH</sub>	Response Time, Output Rise/Fall <sup>(4)</sup>	C <sub>L</sub> =50pF		16.5		ns
t <sub>THL</sub>				13.0		

**Notes:**

- Differential input switching level is guaranteed at the minimum or maximum offset voltage, minus or plus half the maximum hysteresis voltage.
- Guaranteed by design and characterization data
- Input signal: 1kHz, square-wave signal with 10ns edge rate.

## Typical Performance Characteristics

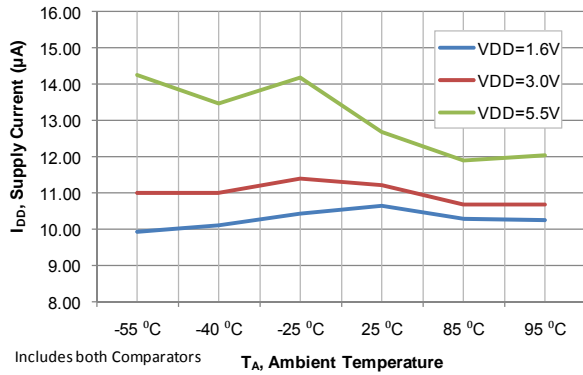

**Figure 4. Supply Current vs. Temperature**

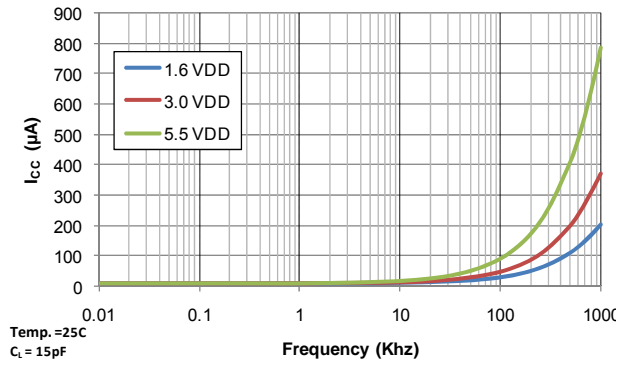

**Figure 5. Supply Current vs. Output Transition Frequency**

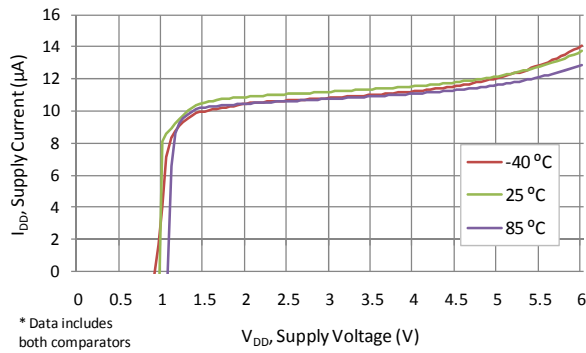

**Figure 6. Supply Current vs. Supply Voltage**

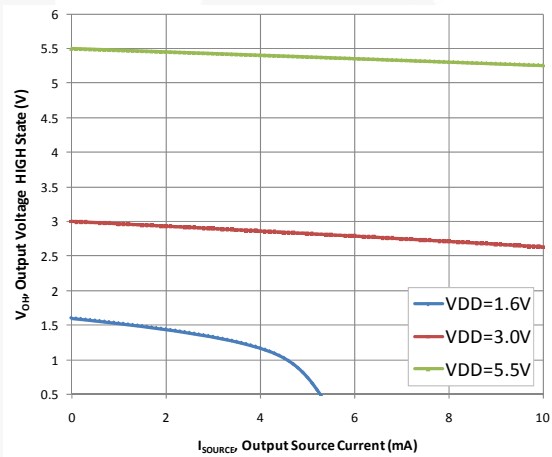

**Figure 7. Output HIGH vs. Output Drive Current**

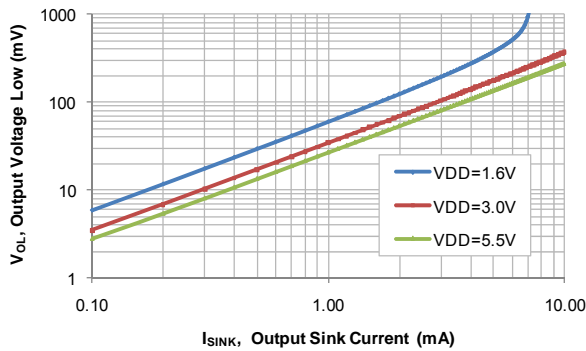

**Figure 8. Output LOW vs. Output Drive Current**

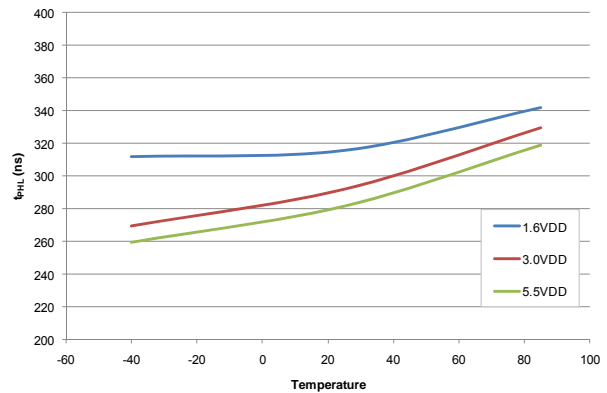

**Figure 9. Propagation Delay (t<sub>PLH</sub>) vs. Temperature**

Typical Performance Characteristics (Continued)

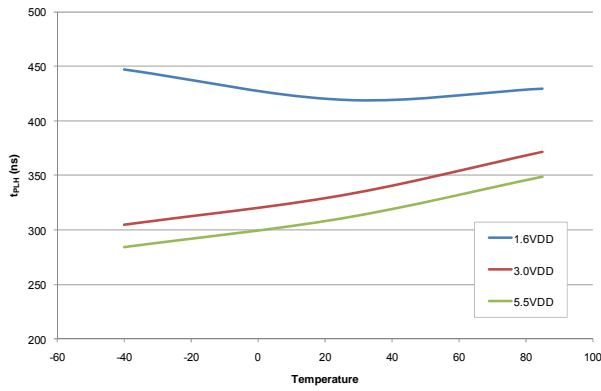

Figure 10. Propagation Delay ( $t_{PLH}$ ) vs. Temperature

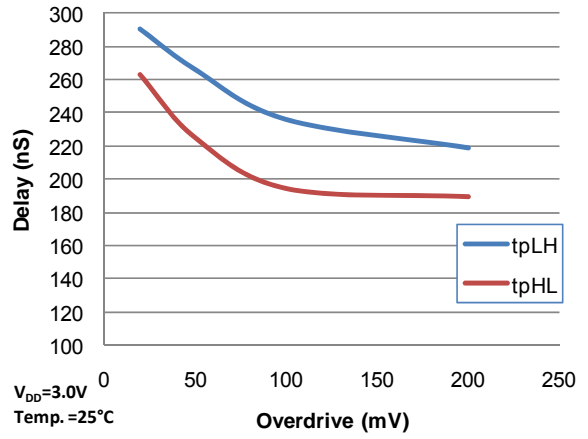

Figure 11. Propagation Delay vs. Input Overdrive

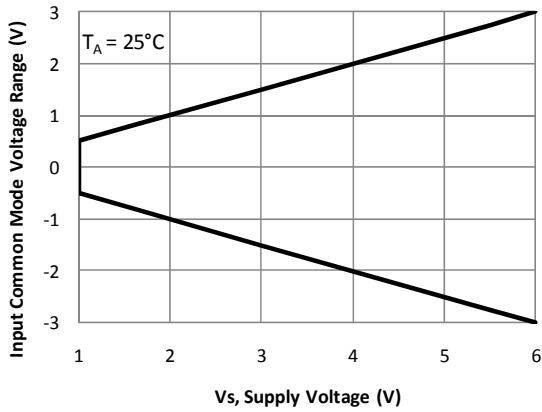

Figure 12. Input Common Mode Voltage Range vs. Supply Voltage

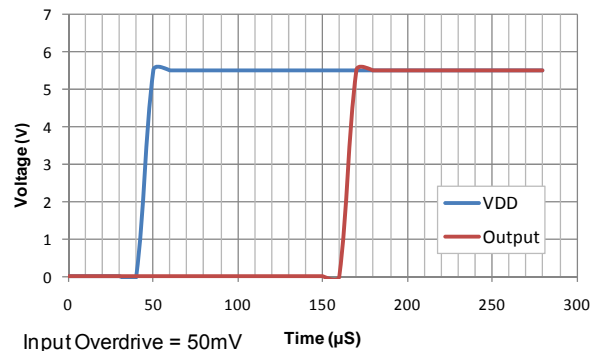
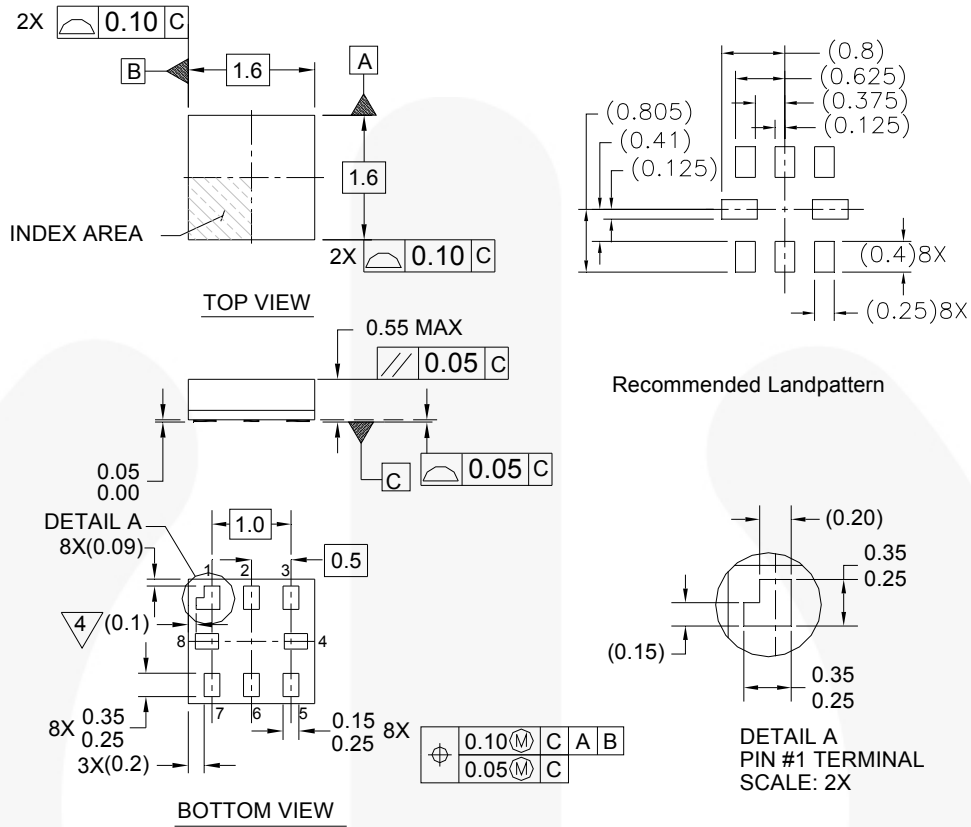

Figure 13. Power-Up Delay

Physical Dimensions



- Notes:
1. PACKAGE CONFORMS TO JEDEC MO-255 VARIATION UAAD
  2. DIMENSIONS ARE IN MILLIMETERS
  3. DRAWING CONFORMS TO ASME Y.14M-1994
  4. PIN 1 FLAG, END OF PACKAGE OFFSET
  5. DRAWING FILE NAME: MKT-MAC08AREV4

MAC08AREV4

Figure 14. 8-Lead, MicroPak™ 1.6mm Wide

Package drawings are provided as a service to customers considering Fairchild components. Drawings may change in any manner without notice. Please note the revision and/or date on the drawing and contact a Fairchild Semiconductor representative to verify or obtain the most recent revision. Package specifications do not expand the terms of Fairchild's worldwide terms and conditions, specifically the warranty therein, which covers Fairchild products.

Always visit Fairchild Semiconductor's online packaging area for the most recent package drawings:  
<http://www.fairchildsemi.com/packaging/>.

Tape and Reel Specifications





Please visit Fairchild Semiconductor's online packaging area for the most recent tape and reel specifications:  
[http://www.fairchildsemi.com/products/logic/pdf/micropak\\_tr.pdf/](http://www.fairchildsemi.com/products/logic/pdf/micropak_tr.pdf/)



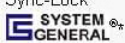

**TRADEMARKS**

The following includes registered and unregistered trademarks and service marks, owned by Fairchild Semiconductor and/or its global subsidiaries, and is not intended to be an exhaustive list of all such trademarks.

- |  |  |  |   |
|--|--|--|---|
| AccuPower™   | FPS™   | Power-SPM™   | The Power Franchise®  |
| Auto-SPM™  | F-PFS™   | PowerTrench®   | The Right Technology for Your Success™  |
| AX-CAPT™   | FRFET®   | PowerXS™   | <b>the power franchises</b>   |
| BitSic®  | Global Power Resource™   | Programmable Active Droop™   | TinyBoost™  |
| Build it Now™  | Green FPS™   | QFET®  | TinyBuck™   |
| CorePLUS™  | Green FPS™ e-Series™   | QS™  | TinyCalc™   |
| CorePOWER™   | Gmax™  | Quiet Series™  | TinyLogic®  |
| CROSSVOL7™   | GTO™   | RapidConfigure™  | TINYOPTO™   |
| CTL™   | IntelliMAX™  |  ™                | TinyPower™  |
| Current Transfer Logic™  | ISOPLANAR™   | Saving our world, 1mW/W at a time™   | TinyPVM™  |
| DEUXPEED®  | MegaBuck™  | SignalWise™  | TinyWire™   |
| Dual Cool™   | MICROCOUPLER™  | SmartMax™  | TranSIC®  |
| EcoSPARK®  | MicroFET™  | SMART START™   | TriFault Detect™  |
| EfficientMax™  | MicroPak™  | SPM®   | TRUECURRENT®*   |
| ESBC™  | MicroPak2™   | STEALTH™   | µSerDes™  |
|  Fairchild® | MillerDrive™   | SuperFET®  |  SerDes® |
| Fairchild Semiconductor®   | MotionMax™   | SuperSOT™-3  | UHC®  |
| FACT Quiet Series™   | Motion-SPM™  | SuperSOT™-8  | Ultra FRFET™  |
| FACT™  | mWSaver™   | SupreMOS®  | UniFET™   |
| FAST®  | OptoHiT™   | SyncFET™   | Vcx™  |
| FastvCore™   | OPTOLOGIC®   | Sync-Lock™   | VisualMax™  |
| FETBench™  | OPTOPLANAR®  |  SYSTEM GENERAL®* | XS™   |
| FlashWriter®*  |  PDP SPM™ |  |   |

\* Trademarks of System General Corporation, used under license by Fairchild Semiconductor.

**DISCLAIMER**

FAIRCHILD SEMICONDUCTOR RESERVES THE RIGHT TO MAKE CHANGES WITHOUT FURTHER NOTICE TO ANY PRODUCTS HEREIN TO IMPROVE RELIABILITY, FUNCTION, OR DESIGN. FAIRCHILD DOES NOT ASSUME ANY LIABILITY ARISING OUT OF THE APPLICATION OR USE OF ANY PRODUCT OR CIRCUIT DESCRIBED HEREIN, NEITHER DOES IT CONVEY ANY LICENSE UNDER ITS PATENT RIGHTS, NOR THE RIGHTS OF OTHERS. THESE SPECIFICATIONS DO NOT EXPAND THE TERMS OF FAIRCHILD'S WORLDWIDE TERMS AND CONDITIONS, SPECIFICALLY THE WARRANTY THEREIN, WHICH COVERS THESE PRODUCTS.

**LIFE SUPPORT POLICY**

FAIRCHILD'S PRODUCTS ARE NOT AUTHORIZED FOR USE AS CRITICAL COMPONENTS IN LIFE SUPPORT DEVICES OR SYSTEMS WITHOUT THE EXPRESS WRITTEN APPROVAL OF FAIRCHILD SEMICONDUCTOR CORPORATION.

As used herein:

1. Life support devices or systems are devices or systems which, (a) are intended for surgical implant into the body or (b) support or sustain life, and (c) whose failure to perform when properly used in accordance with instructions for use provided in the labeling, can be reasonably expected to result in a significant injury of the user.
2. A critical component in any component of a life support device, or system whose failure to perform can be reasonably expected to cause the failure of the life support device or system, or to affect its safety or effectiveness.

**ANTI-COUNTERFEITING POLICY**

Fairchild Semiconductor Corporation's Anti-Counterfeiting Policy. Fairchild's Anti-Counterfeiting Policy is also stated on our external website, [www.fairchildsemi.com](http://www.fairchildsemi.com), under Sales Support.

Counterfeiting of semiconductor parts is a growing problem in the industry. All manufacturers of semiconductor products are experiencing counterfeiting of their parts. Customers who inadvertently purchase counterfeit parts experience many problems such as loss of brand reputation, substandard performance, failed applications, and increased cost of production and manufacturing delays. Fairchild is taking strong measures to protect ourselves and our customers from the proliferation of counterfeit parts. Fairchild strongly encourages customers to purchase Fairchild parts either directly from Fairchild or from Authorized Fairchild Distributors who are listed by country on our web page cited above. Products customers buy either from Fairchild directly or from Authorized Fairchild Distributors are genuine parts, have full traceability, meet Fairchild's quality standards for handling and storage and provide access to Fairchild's full range of up-to-date technical and product information. Fairchild and our Authorized Distributors will stand behind all warranties and will appropriately address any warranty issues that may arise. Fairchild will not provide any warranty coverage or other assistance for parts bought from Unauthorized Sources. Fairchild is committed to combat this global problem and encourage our customers to do their part in stopping this practice by buying direct or from authorized distributors.

**PRODUCT STATUS DEFINITIONS**

**Definition of Terms**

Datasheet Identification	Product Status	Definition
Advance Information	Formative / In Design	Datasheet contains the design specifications for product development. Specifications may change in any manner without notice.
Preliminary	First Production	Datasheet contains preliminary data; supplementary data will be published at a later date. Fairchild Semiconductor reserves the right to make changes at any time without notice to improve design.
No Identification Needed	Full Production	Datasheet contains final specifications. Fairchild Semiconductor reserves the right to make changes at any time without notice to improve the design.
Obsolete	Not In Production	Datasheet contains specifications on a product that is discontinued by Fairchild Semiconductor. The datasheet is for reference information only.

Rev. 154