



Description

The SE5218 series of fixed output low dropout linear regulators are designed for portable battery powered applications, which require low noise environment, fast enable response time, and low dropout voltage. Each device contains a bandgap voltage reference, an error amplifier, a PMOS power transistor, and resistors for setting output voltage, and current limit and temperature limit protection circuits.

The SE5218 has been designed to be used with low cost capacitors and requires a minimum output capacitor of 1.0 μ F. Standard voltage versions are 1.5, 1.8, 2.5, 2.8, 3.0, and 3.3V.

Features

- Typical 175mV Dropout Voltage at 150mA.
- Fast Enable Turn-On Time of 20 μ s (Typ.)
- Excellent Line and Load Regulation.
- High Accuracy Output Voltage of 2%.
- Ultra-Low Ground Current at 65 μ A (Typ.)
- Disable Current Less than 0.3 μ A (Typ.)
- Thermal Protection.
- Standard SOT-23-5L Packages.

Applications

- USB removable devices
- MPEG4 devices
- Wireless LAN's
- Hand-Held Instrumentation.
- Portable DVD players
- Digital camera

Pin Configuration

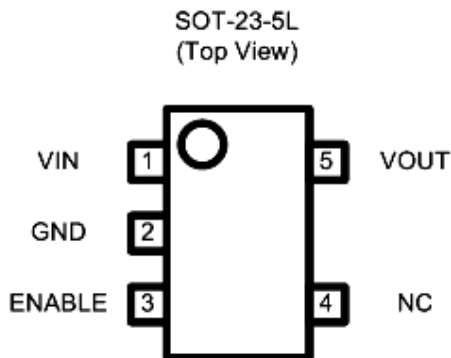

Application Diagram

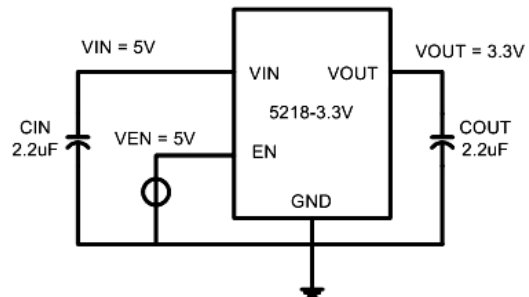



Ordering/Marking Information

Package	Ordering Information		Marking Information	
<p>SOT-23-5L (Top View)</p>	3.3V	SE5218ALG-LF	218Alz [•]	<p>Starting with 5, a bar on top of 5 is for production year 2001, and underlined 5 is for year 2002. The next character is marked on top for 2003, and underlined for 2004. The naming pattern continues with consecutive characters for later years.</p> <p>The last character is the week code. (A-Z: 1-26, a-z: 27-52)</p> <p>A dot on top right corner is for lead-free process.</p>
	2.8V	SE5218BLG-LF	218BLz [•]	
	2.5V	SE5218CLG-LF	218CLz [•]	
	1.8V	SE5218DLG-LF	218DLz [•]	
	1.5V	SE5218ELG-LF	218ELz [•]	
	3.0V	SE5218FLG-LF	218FLz [•]	

Absolute Maximum Rating ⁽¹⁾

Parameter	Symbol	Value	Units
Input Voltage	V _{IN}	6	V
Enable Voltage	V _{EN}	-0.3 to V _{IN}	V
Power Dissipation	P _D	Internally Limited ⁽³⁾	
Output Short Circuit Duration		Infinite	
Thermal Resistance, Junction-to-Ambient	Θ _{JA}	230 (SOT-23-5L)	°C/W
Lead Temperature (Soldering, 5 sec.)		260	°C
Junction Temperature	T _J	+150	°C
Storage Temperature	T _S	-40 to +150	°C

Operating Rating ⁽²⁾

Parameter	Symbol	Value	Units
Supply Input Voltage	V _{IN}	+2.8V to +5.5	V
Junction Temperature	T _J	0 to +125	°C



Electrical Characteristics

$V_{IN} = 5V$; $V_{EN} = V_{IN}$; $C_{IN} = 2.2\mu F$; $C_{OUT} = 2.2\mu F$ (Electrolytic capacitor) ; $I_{OUT} = 10mA$; $T_J = 25^\circ C$; unless otherwise specified.

Symbol	Parameter	Conditions	Min	Typ	Max	Unit	
V_{OUT}	Output Voltage Accuracy	SE5218 – 1.5($V_{IN} = 3.3V$)	1.470	1.5	1.530	V	
		SE5218 – 1.8($V_{IN} = 3.3V$)	1.764	1.8	1.836		
		SE5218 – 2.5	2.450	2.5	2.550		
		SE5218 – 2.8	2.744	2.8	2.856		
		SE5218 – 3.0	2.940	3.0	3.060		
		SE5218 – 3.3	3.234	3.3	3.366		
ΔV_{OUT}	Line Regulation	$V_{IN} = (V_{OUT} + 1)V$ to 5.5V	--	1.0	--	%/V	
ΔV_{OUT}	Load Regulation ⁽⁵⁾	$V_{IN} = (V_{OUT} + 0.8)V$ or 2.5V	$I_{OUT} = 10mA$ to 250mA	--	1.0	--	%
			$I_{OUT} = 10mA$ to 500mA	--	1.5	--	
$\Delta V_{OUT}/\Delta T$	Output Voltage Temperature Coefficient	Note 4	--	0.025	--	mV/°C	
$V_{IN} - V_{OUT}$	Dropout Voltage ⁽⁶⁾	$I_{OUT} = 10mA$	15			mV	
		$I_{OUT} = 150mA$	175				
		$I_{OUT} = 250mA$	320				
		$I_{OUT} = 400mA$	600				
$T_{PROTECTION}$	Thermal Protection	Thermal Protection Temperature	--	150	--	°C	
		Protection Hysteresis	--	20	--		
PSRR	Ripple Rejection	f = 120 Hz	--	59	--	dB	
I_Q	Quiescent Current	$V_{EN} = 0.4V$	--	0.3	--	μA	
		$V_{EN} = V_{IN}$	--	65	--		
$V_{TH(EN)}$	Enable Input Threshold Voltage	Voltage Increasing, Output Turns On, Logic High	1.6	--	--	V	
		Voltage Decreasing, Output Turns Off, Logic Low	--	--	0.4		
I_{LIMIT}	Current Limit		--	800	--	mA	



Note 1: Exceeding the absolute maximum rating may damage the device.

Note 2: The device is not guaranteed to function outside its operating rating.

Note 3: The maximum allowable power dissipation at any T_A (ambient temperature) is calculated using: $P_{D(MAX)} = (T_{J(MAX)} - T_A)/\theta_{JA}$. Exceeding the maximum allowable power dissipation will result in excessive die temperature, and the regulator will go into thermal shutdown. See "Thermal Consideration" section for details

Note 4: Output voltage temperature coefficient is the worst case voltage change divided by the total temperature range.

Note 5: Regulation is measured at constant junction temperature using low duty cycle pulse testing. Parts are tested for load regulation in the load range from 10mA to 500mA. Changes in output voltage due to heating effects are covered by the thermal regulation specification.

Note 6: Dropout voltage is defined as the input to output differential at which the output voltage drops 2% below its nominal value measured at 1V differential.

Note 7: The C_{in} or C_{out} should be chosen carefully. Please refer to the Application Hints

Block Diagram

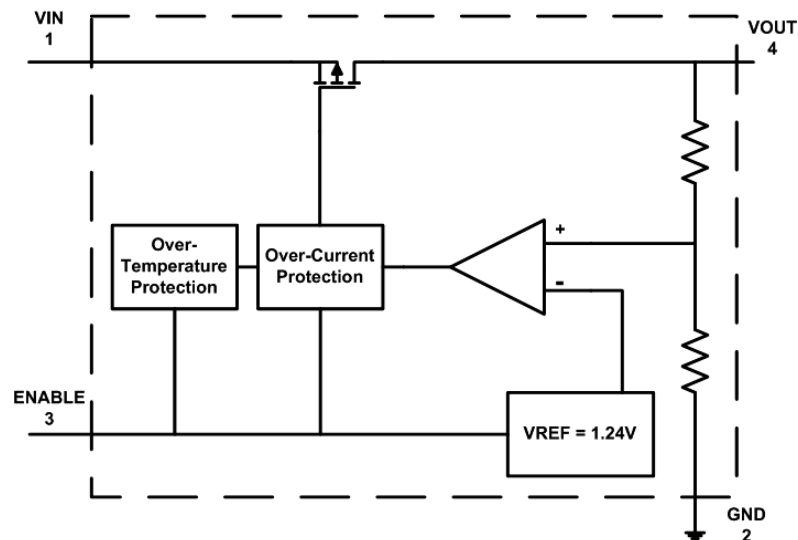



Line Regulation (VOUT = 3.3V)
(VIN = 4.3V to 6V, IOOUT = 10mA)

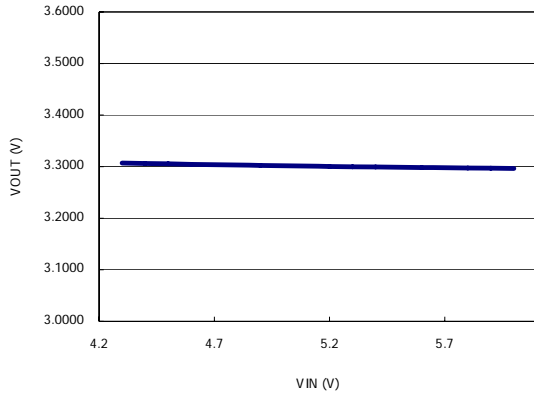

Load Regulation (VOUT = 3.3V)
(VIN = 5V, IOOUT = 10mA to 500mA)

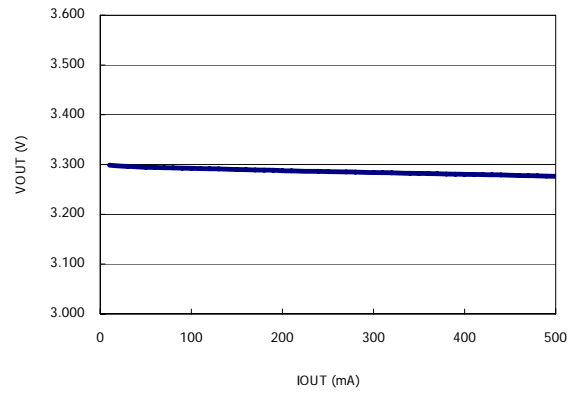

Output Voltage vs Temperature
(VIN = 5V, IOOUT = 10mA)

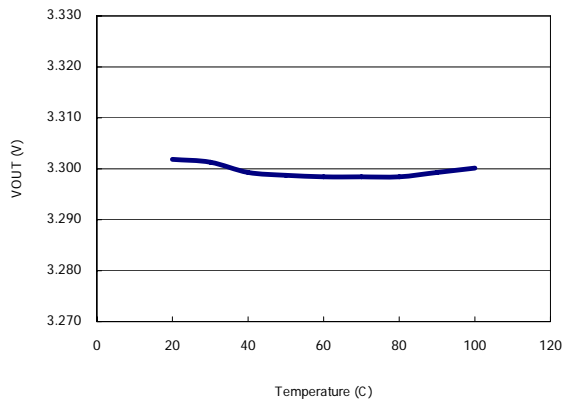

IQ vs IOOUT
(VIN = 5V, IOOUT = 10mA to 500mA)

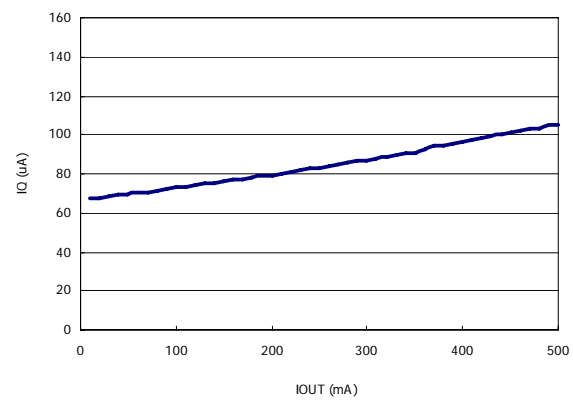

PSRR (VOUT = 3.3)
(VIN = 5V, VPP = 1V)

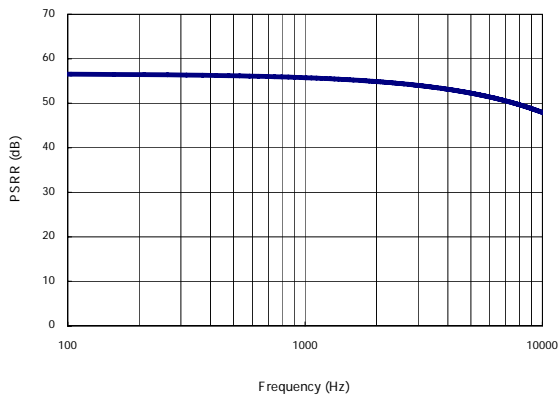

Transient Response (VOUT = 3.3V)
(IOOUT = 10mA to 40mA)

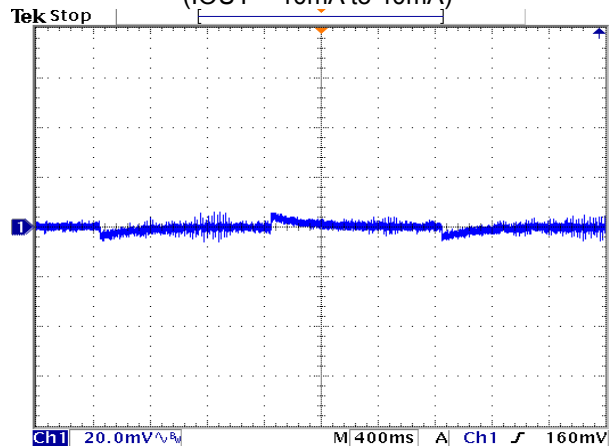



Application Hints

Like any low dropout regulator, SE5218 requires external capacitors to ensure stability. The external capacitors must be carefully selected to ensure performance.

Input Capacitor

An input capacitor of at least 1 μ F is required. The inexpensive Electrolytic capacitor is preferred. The value can be increased without upper limit.

Output Capacitor

An output capacitor is required for stability. It must be placed no more than 1 cm away from the V_{OUT} pin, and connected directly between V_{OUT} and GND pins. The inexpensive Electrolytic capacitor is recommended. The minimum value is 1 μ F but may be increased without limit.

Thermal Considerations

It is important that the thermal limit of the package is not exceeded. The SE5218 has built-in thermal protection. When the thermal limit is exceeded, the IC will enter protection, and V_{OUT} will be pulled to ground. The power dissipation for a given application can be calculated as following:

The power dissipation (P_D) is

$$P_D = I_{OUT} * [V_{IN} - V_{OUT}]$$

The thermal limit of the package is then limited to P_{D(MAX)} = [T_J - T_A]/ Θ_{JA} where T_J is the junction temperature, T_A is the ambient temperature, and Θ_{JA} for SOT-23-5L is around 230°C/W for SE5218. SE5218 is designed to enter thermal protection at 150°C. For example, if T_A is 25°C then the maximum P_D is limited to about 0.6W. In other words, if I_{OUT(MAX)} = 400mA, then [V_{IN} - V_{OUT}] cannot exceed 1.5V.



Outline Drawing SOT-23-5L

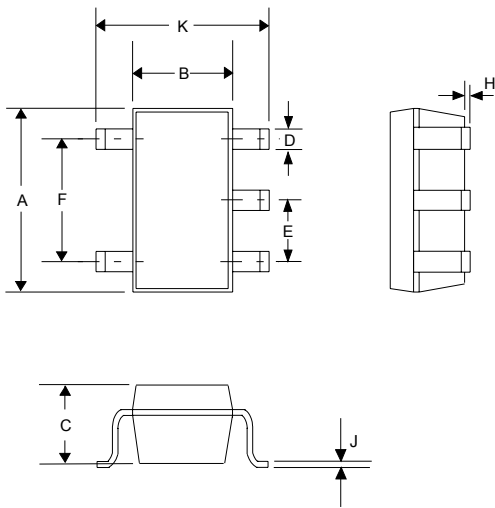

DIMENSIONS				
DIM ^N	INCHES		MM	
	MIN	MAX	MIN	MAX
A	0.110	0.120	2.80	3.05
B	0.059	0.070	1.50	1.75
C	0.036	0.051	0.90	1.30
D	0.014	0.020	0.35	0.50
E	-	0.037	-	0.95
F	-	0.075	-	1.90
H	-	0.006	-	0.15
J	0.0035	0.008	0.090	0.20
K	0.102	0.118	2.60	3.00

Customer Support

Seaward Electronics Incorporated – China

Section B, 2nd Floor, ShangDi Scientific Office Complex, #22 XinXi Road

Haidian District, Beijing 100085, China

Tel: 86-10-8289-5700/01/05

Fax: 86-10-8289-5706

Seaward Electronics Corporation – Taiwan

2F, #181, Sec. 3, Minguan East Rd,

Taipei, Taiwan R.O.C

Tel: 886-2-2712-0307

Fax: 886-2-2712-0191

Seaward Electronics Incorporated – North America

1512 Centre Pointe Dr.

Milpitas, CA95035, USA

Tel: 1-408-821-6600

Last Updated - 12/5/2008

Revision 12/5/2008

Preliminary and all contents are subject to change without prior notice.

© Seaward Electronics, Inc., 2005. • www.seawardinc.com.cn • Page 7