

LMV921 Single/ LMV922 Dual/ LMV924 Quad 1.8V, 1MHz, Low Power Operational Amplifiers with Rail-To-Rail Input and Output

General Description

The LMV921 Single/LMV922 Dual/LMV924 Quad are guaranteed to operate from +1.8V to +5.0V supply voltages and have rail-to-rail input and output. This rail-to-rail operation enables the user to make full use of the entire supply voltage range. The input common mode voltage range extends 300mV beyond the supplies and the output can swing rail-to-rail unloaded and within 100mV from the rail with 600Ω load at 1.8V supply. The LMV921/LMV922/LMV924 are optimized to work at 1.8V which make them ideal for portable two-cell battery-powered systems and single cell Li-Ion systems.

The LMV921/LMV922/LMV924 exhibit excellent speed-power ratio, achieving 1MHz gain bandwidth product at 1.8V supply voltage with very low supply current. The LMV921/LMV922/LMV924 are capable of driving 600Ω load and up to 1000pF capacitive load with minimal ringing. The LMV921/LMV922/LMV924's high DC gain of 100dB makes them suitable for low frequency applications.

The LMV921 (Single) is offered in a space saving SC70-5 and SOT23-5 packages. The SC70-5 package is only 2.0X2.1X1.0mm. These small packages are ideal solutions for area constrained PC boards and portable electronics such as cellphones and PDAs.

Features

(Typical 1.8V Supply Values; Unless Otherwise Noted)

- Guaranteed 1.8V, 2.7V and 5V specifications
- Rail-to-Rail input & output swing
 - w/600Ω load 100 mV from rail
 - w/2kΩ load 30 mV from rail
- V_{CM} 300mV beyond rails
- 90dB gain w/600Ω load
- Supply current 145μA/amplifier
- Gain bandwidth product 1MHz
- LMV921 Maximum V_{OS} 6mV
- LMV921 available in Ultra Tiny, SC70-5 package
- LMV922 available in MSOP-8 package
- LMV924 available in TSSOP-14 package

Applications

- Cordless/cellular phones
- Laptops
- PDAs
- PCMCIA
- Portable/battery-powered electronic Equipment
- Supply current Monitoring
- Battery monitoring

Connection Diagrams

5-Pin SC70-5/SOT23-5

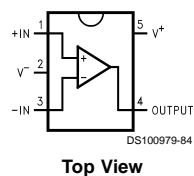

8-Pin MSOP/SOIC

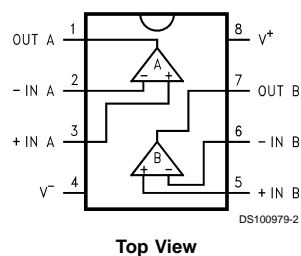
LMV921 Single/ LMV922 Dual/ LMV924 Quad 1.8V, 1MHz, Low Power Operational Amplifiers with Rail-To-Rail Input and Output

Connection Diagrams (Continued)

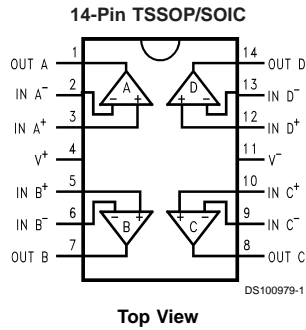

Ordering Information

Package	Temperature Range Industrial -40°C to +85°C	Packaging Marking	Transport Media	NSC Drawing
5-Pin SC70-5	LMV921M7	A21	1k Units Tape and Reel	MAA05A
	LMV921M7X	A21	3k Units Tape and Reel	
5-Pin SOT23-5	LMV921M5	A29A	1k Units Tape and Reel	MA05B
	LMV921M5X	A29A	3k Units Tape and Reel	
8-Pin MSOP	LMV922MM	LMV922	1k Units Tape and Reel	MUA08A
	LMV922MMX	LMV922	3.5k Units Tape and Reel	
14-Pin TSSOP	LMV924MT	LMV924	Rails	MTC14
	LMV924MTX	LMV924	2.5k Units Tape and Reel	
8-Pin SOIC	LMV922M	LMV922M	Rails	M08A
	LMV922MX	LMV922M	2.5k Units Tape and Reel	
14-Pin SOIC	LMV924M	LMV924M	Rails	M14A
	LMV924MX	LMV924M	2.5k Units Tape and Reel	

Absolute Maximum Ratings (Note 1)

If Military/Aerospace specified devices are required, please contact the National Semiconductor Sales Office/ Distributors for availability and specifications.

ESD Tolerance (Note 2)	
Machine Model	100V
Human Body Model	2000V
Differential Input Voltage	± Supply Voltage
Supply Voltage ($V^+ - V^-$)	5.5V
Output Short Circuit to V^+ (Note 3)	
Output Short Circuit to V^- (Note 3)	
Storage Temperature Range	-65°C to 150°C
Junction Temperature (Note 4)	150°C
Mounting Temp.	
Infrared or Convection (20 sec)	235°C

Operating Ratings (Note 1)

Supply Voltage	1.5V to 5.0V
Temperature Range	-40°C ≤ T_J ≤ 85°C
Thermal Resistance (θ_{JA})	
Ultra Tiny SC70-5 Package	
5-Pin Surface Mount	440 °C/W
Tiny SOT23-5 Package	
5-Pin Surface Mount	265 °C/W
MSOP Package	
8-Pin Surface Mount	235 °C/W
TSSOP Package	
14-Pin Surface Mount	155 °C/W
SOIC Package	
8-Pin Surface Mount	175 °C/W
14-Pin Surface Mount	127 °C/W

1.8V DC Electrical Characteristics

Unless otherwise specified, all limits guaranteed for $T_J = 25^\circ\text{C}$. $V^+ = 1.8\text{V}$, $V^- = 0\text{V}$, $V_{CM} = V^+/2$, $V_O = V^+/2$ and $R_L > 1\text{M}\Omega$. **Boldface** limits apply at the temperature extremes.

Symbol	Parameter	Condition	Typ (Note 5)	Limits (Note 6)	Units
V_{OS}	Input Offset Voltage	LMV921 (Single)	-1.8	6 8	mV max
		LMV922 (Dual) LMV924 (Quad)	-1.8	8 9.5	mV max
TCV_{OS}	Input Offset Voltage Average Drift		1		$\mu\text{V}/^\circ\text{C}$
I_B	Input Bias Current		12	35 50	nA max
I_{OS}	Input Offset Current		2	25 40	nA max
I_S	Supply Current	LMV921 (Single)	145	185 205	μA max
		LMV922 (Dual)	330	400 550	
		LMV924 (Quad)	560	700 850	
CMRR	Common Mode Rejection Ratio	$0 \leq V_{CM} \leq 0.6\text{V}$	82	62 60	dB min
		$-0.2\text{V} \leq V_{CM} \leq 0\text{V}$ $1.8\text{V} \leq V_{CM} \leq 2.0\text{V}$	74	50	
PSRR	Power Supply Rejection Ratio	$1.8\text{V} \leq V^+ \leq 5\text{V}$, $V_{CM} = 0.5\text{V}$	78	67 62	dB min
V_{CM}	Input Common-Mode Voltage Range	For CMRR ≥ 50dB	-0.3	-0.2 0	V max
			2.15	2.0 1.8	V min
A_V	Large Signal Voltage Gain LMV921 (Single)	$R_L = 600\Omega$ to 0.9V, $V_O = 0.2\text{V}$ to 1.6V, $V_{CM} = 0.5\text{V}$	91	77 73	dB min
		$R_L = 2\text{k}\Omega$ to 0.9V, $V_O = 0.2\text{V}$ to 1.6V, $V_{CM} = 0.5\text{V}$	95	80 75	
	Large Signal Voltage Gain LMV922 (Dual) LMV924 (Quad)	$R_L = 600\Omega$ to 0.9V, $V_O = 0.2\text{V}$ to 1.6V, $V_{CM} = 0.5\text{V}$	79	65 61	dB min
		$R_L = 2\text{k}\Omega$ to 0.9V, $V_O = 0.2\text{V}$ to 1.6V, $V_{CM} = 0.5\text{V}$	83	68 63	

1.8V DC Electrical Characteristics (Continued)

Unless otherwise specified, all limits guaranteed for $T_J = 25^\circ\text{C}$. $V^+ = 1.8\text{V}$, $V^- = 0\text{V}$, $V_{\text{CM}} = V^+/2$, $V_O = V^+/2$ and $R_L > 1\text{M}\Omega$. **Boldface** limits apply at the temperature extremes.

Symbol	Parameter	Condition	Typ (Note 5)	Limits (Note 6)	Units
V_O	Output Swing	$R_L = 600\Omega$ to 0.9V $V_{\text{IN}} = \pm 100\text{mV}$	1.7	1.65 1.63	V min
			0.075	0.090 0.105	V max
		$R_L = 2\text{k}\Omega$ to 0.9V $V_{\text{IN}} = \pm 100\text{mV}$	1.77	1.75 1.74	V min
			0.025	0.035 0.040	V max
I_O	Output Short Circuit Current	Sourcing, $V_O = 0\text{V}$ $V_{\text{IN}} = 100\text{mV}$	6	4 3.3	mA min
		Sinking, $V_O = 1.8\text{V}$ $V_{\text{IN}} = -100\text{mV}$	10	7 5	mA min

1.8V AC Electrical Characteristics

Unless otherwise specified, all limits guaranteed for $T_J = 25^\circ\text{C}$. $V^+ = 1.8\text{V}$, $V^- = 0\text{V}$, $V_{\text{CM}} = V^+/2$, $V_O = V^+/2$ and $R_L > 1\text{M}\Omega$. **Boldface** limits apply at the temperature extremes.

Symbol	Parameter	Conditions	Typ (Note 5)	Units
SR	Slew Rate	(Note 7)	0.39	V/ μs
GBW	Gain-Bandwidth Product		1	MHz
Φ_m	Phase Margin		60	Deg.
G_m	Gain Margin		10	dB
e_n	Input-Referred Voltage Noise	$f = 1\text{kHz}$, $V_{\text{CM}} = 0.5\text{V}$	45	$\frac{\text{nV}}{\sqrt{\text{Hz}}}$
i_n	Input-Referred Current Noise	$f = 1\text{kHz}$	0.1	$\frac{\text{pA}}{\sqrt{\text{Hz}}}$
THD	Total Harmonic Distortion	$f = 1\text{kHz}$, $A_V = +1$ $R_L = 600\text{k}\Omega$, $V_{\text{IN}} = 1\text{V}_{\text{PP}}$	0.089	%
	Amp-to-Amp Isolation	(Note 8)	140	dB

2.7V DC Electrical Characteristics

Unless otherwise specified, all limits guaranteed for $T_J = 25^\circ\text{C}$. $V^+ = 2.7\text{V}$, $V^- = 0\text{V}$, $V_{\text{CM}} = V^+/2$, $V_O = V^+/2$ and $R_L > 1\text{M}\Omega$. **Boldface** limits apply at the temperature extremes.

Symbol	Parameter	Condition	Typ (Note 5)	Limits (Note 6)	Units
V_{OS}	Input Offset Voltage	LMV921 (Single)	-1.6	6 8	mV max
		LMV922 (Dual)	-1.6	8 9.5	mV max
		LMV924 (Quad)			
TCV_{OS}	Input Offset Voltage Average Drift		1		$\mu\text{V}/^\circ\text{C}$
I_B	Input Bias Current		12	35 50	nA max
I_{OS}	Input Offset Current		2	25 40	nA max

2.7V DC Electrical Characteristics (Continued)

Unless otherwise specified, all limits guaranteed for $T_J = 25^\circ\text{C}$. $V^+ = 2.7\text{V}$, $V^- = 0\text{V}$, $V_{\text{CM}} = V^+/2$, $V_O = V^+/2$ and $R_L > 1\text{ M}\Omega$. **Boldface** limits apply at the temperature extremes.

Symbol	Parameter	Condition	Typ (Note 5)	Limits (Note 6)	Units
I_S	Supply Current	LMV921 (Single)	147	190 210	uA max
		LMV922 (Dual)	380	450 600	
		LMV924 (Quad)	580	750 900	
CMRR	Common Mode Rejection Ratio	$0\text{V} \leq V_{\text{CM}} \leq 1.5\text{V}$	84	62 60	dB min
		$-0.2\text{V} \leq V_{\text{CM}} \leq 0\text{V}$ $2.7\text{V} \leq V_{\text{CM}} < 2.9\text{V}$	73	50	
PSRR	Power Supply Rejection Ratio	$1.8\text{V} \leq V^+ \leq 5\text{V}$, $V_{\text{CM}} = 0.5\text{V}$	78	67 62	dB min
V_{CM}	Input Common-Mode Voltage Range	For CMRR $\geq 50\text{dB}$	-0.3	-0.2 0	V max
			3.050	2.9 2.7	V min
A_V	Large Signal Voltage Gain LMV921 (Single)	$R_L = 600\Omega$ to 1.35V, $V_O = 0.2\text{V}$ to 2.5V	98	80 75	dB min
		$R_L = 2\text{k}\Omega$ to 1.35V, $V_O = 0.2\text{V}$ to 2.5V	103	83 77	
	Large Signal Voltage Gain LMV922 (Dual) LMV924 (Quad)	$R_L = 600\Omega$ to 1.35V, $V_O = 0.2\text{V}$ to 2.5V	86	68 63	dB min
		$R_L = 2\text{k}\Omega$ to 1.35V, $V_O = 0.2\text{V}$ to 2.5V	91	71 65	
V_O	Output Swing	$R_L = 600\Omega$ to 1.35V $V_{\text{IN}} = \pm 100\text{mV}$	2.62	2.550 2.530	V min
			0.075	0.095 0.115	V max
		$R_L = 2\text{k}\Omega$ to 1.35V $V_{\text{IN}} = \pm 100\text{mV}$	2.675	2.650 2.640	V min
			0.025	0.040 0.045	V max
I_O	Output Short Circuit Current	Sourcing, $V_O = 0\text{V}$ $V_{\text{IN}} = 100\text{mV}$	27	20 15	mA min
		Sinking, $V_O = 2.7\text{V}$ $V_{\text{IN}} = -100\text{mV}$	28	22 16	mA min

2.7V AC Electrical Characteristics

Unless otherwise specified, all limits guaranteed for $T_J = 25^\circ\text{C}$. $V^+ = 2.7\text{V}$, $V^- = 0\text{V}$, $V_{\text{CM}} = 1.0\text{V}$, $V_O = 1.35\text{V}$ and $R_L > 1\text{ M}\Omega$. **Boldface** limits apply at the temperature extremes.

Symbol	Parameter	Conditions	Typ (Note 5)	Units
SR	Slew Rate	(Note 7)	0.41	V/ μs
GBW	Gain-Bandwidth Product		1	MHz
Φ_m	Phase Margin		65	Deg.
G_m	Gain Margin		10	dB
e_n	Input-Referred Voltage Noise	$f = 1\text{ kHz}$, $V_{\text{CM}} = 0.5\text{V}$	45	$\frac{\text{nV}}{\sqrt{\text{Hz}}}$
i_n	Input-Referred Current Noise	$f = 1\text{ kHz}$	0.1	$\frac{\text{pA}}{\sqrt{\text{Hz}}}$

2.7V AC Electrical Characteristics (Continued)

Unless otherwise specified, all limits guaranteed for $T_J = 25^\circ\text{C}$. $V^+ = 2.7\text{V}$, $V^- = 0\text{V}$, $V_{\text{CM}} = 1.0\text{V}$, $V_{\text{O}} = 1.35\text{V}$ and $R_L > 1\text{M}\Omega$. **Boldface** limits apply at the temperature extremes.

Symbol	Parameter	Conditions	Typ (Note 5)	Units
THD	Total Harmonic Distortion	$f = 1\text{ kHz}$, $A_V = +1$ $R_L = 600\text{k}\Omega$, $V_{\text{IN}} = 1\text{ V}_{\text{PP}}$	0.077	%
	Amp-to-Amp Isolation	(Note 8)	140	dB

5V DC Electrical Characteristics

Unless otherwise specified, all limits guaranteed for $T_J = 25^\circ\text{C}$. $V^+ = 5\text{V}$, $V^- = 0\text{V}$, $V_{\text{CM}} = V^+/2$, $V_{\text{O}} = V^+/2$ and $R_L > 1\text{M}\Omega$. **Boldface** limits apply at the temperature extremes.

Symbol	Parameter	Condition	Typ (Note 5)	Limits (Note 6)	Units
V_{OS}	Input Offset Voltage	LMV921 (Single)	-1.5	6 8	mV max
		LMV922 (Dual) LMV924 (Quad)	-1.5	8 9.5	mV max
TCV_{OS}	Input Offset Voltage Average Drift		1		$\mu\text{V}/^\circ\text{C}$
I_{B}	Input Bias Current		12	35 50	nA max
I_{OS}	Input Offset Current		2	25 40	nA max
I_{S}	Supply Current	LMV921 (Single)	160	210 230	μA max
		LMV922 (Dual)	400	500 700	
		LMV924 (Quad)	750	850 980	
CMRR	Common Mode Rejection Ratio	$0\text{V} \leq V_{\text{CM}} \leq 3.8\text{V}$	86	62 61	dB min
		$-0.2\text{V} \leq V_{\text{CM}} \leq 0\text{V}$ $5.0\text{V} \leq V_{\text{CM}} \leq 5.2\text{V}$	72	50	
PSRR	Power Supply Rejection Ratio	$1.8\text{V} \leq V^+ \leq 5\text{V}$ $V_{\text{CM}} = 0.5\text{V}$	78	67 62	dB min
V_{CM}	Input Common-Mode Voltage Range	For CMRR $\geq 50\text{dB}$	-0.3	-0.2 0	V max
			5.350	5.2 5.0	V min
A_V	Voltage Gain LMV921 (Single)	$R_L = 600\Omega$ to 2.5V $V_{\text{O}} = 0.2\text{V}$ to 4.8V	104	86 82	dB min
		$R_L = 2\text{k}\Omega$ to 2.5V $V_{\text{O}} = 0.2\text{V}$ to 4.8V	108	89 85	
	Voltage Gain LMV922 (Dual) LMV924 (Quad)	$R_L = 600\Omega$ to 2.5V $V_{\text{O}} = 0.2\text{V}$ to 4.8V	90	72 68	dB min
		$R_L = 2\text{k}\Omega$ to 2.5V $V_{\text{O}} = 0.2\text{V}$ to 4.8V	96	77 73	

5V DC Electrical Characteristics (Continued)

Unless otherwise specified, all limits guaranteed for $T_J = 25^\circ\text{C}$. $V^+ = 5\text{V}$, $V^- = 0\text{V}$, $V_{\text{CM}} = V^+/2$, $V_O = V^+/2$ and $R_L > 1\text{ M}\Omega$. **Boldface** limits apply at the temperature extremes.

Symbol	Parameter	Condition	Typ (Note 5)	Limits (Note 6)	Units
V_O	Output Swing	$R_L = 600\Omega$ to 2.5V $V_{\text{IN}} = \pm 100\text{mV}$	4.895	4.865 4.840	V min
			0.1	0.135 0.160	V max
		$R_L = 2\text{k}\Omega$ to 2.5V $V_{\text{IN}} = \pm 100\text{mV}$	4.965	4.945 4.935	V min
			0.035	0.065 0.075	V max
I_O	Output Short Circuit Current	LMV921 Sourcing, $V_O = 0\text{V}$ $V_{\text{IN}} = 100\text{mV}$	98	85 68	mA min
		LMV922, LMV924 Sourcing, $V_O = 0\text{V}$ $V_{\text{IN}} = 100\text{mV}$	60	35	
		Sinking, $V_O = 5\text{V}$ $V_{\text{IN}} = -100\text{mV}$	75	65 45	mA min

5V AC Electrical Characteristics

Unless otherwise specified, all limits guaranteed for $T_J = 25^\circ\text{C}$. $V^+ = 5\text{V}$, $V^- = 0\text{V}$, $V_{\text{CM}} = V^+/2$, $V_O = 2.5\text{V}$ and $R_L > 1\text{ M}\Omega$. **Boldface** limits apply at the temperature extremes.

Symbol	Parameter	Conditions	Typ (Note 5)	Units
SR	Slew Rate	(Note 7)	0.45	V/ μs
GBW	Gain-Bandwidth Product		1	MHz
Φ_m	Phase Margin		70	Deg.
G_m	Gain Margin		15	dB
e_n	Input-Referred Voltage Noise	$f = 1\text{ kHz}$, $V_{\text{CM}} = 1\text{V}$	45	$\frac{\text{nV}}{\sqrt{\text{Hz}}}$
i_n	Input-Referred Current Noise	$f = 1\text{ kHz}$	0.1	$\frac{\text{pA}}{\sqrt{\text{Hz}}}$
THD	Total Harmonic Distortion	$f = 1\text{ kHz}$, $A_V = +1$ $R_L = 600\Omega$, $V_O = 1\text{ V}_{\text{PP}}$	0.069	%
	Amp-to-Amp Isolation	(Note 8)	140	dB

Note 1: Absolute Maximum Ratings indicate limits beyond which damage to the device may occur. Operating Ratings indicate conditions for which the device is intended to be functional, but specific performance is not guaranteed. For guaranteed specifications and the test conditions, see the Electrical Characteristics.

Note 2: Human body model, 1.5 k Ω in series with 100 pF. Machine model, 200 Ω in series with 100 pF.

Note 3: Applies to both single-supply and split-supply operation. Continuous short circuit operation at elevated ambient temperature can result in exceeding the maximum allowed junction temperature of 150°C. Output currents in excess of 45 mA over long term may adversely affect reliability.

Note 4: The maximum power dissipation is a function of $T_{\text{J(max)}}$, θ_{JA} , and T_A . The maximum allowable power dissipation at any ambient temperature is $P_D = (T_{\text{J(max)}} - T_A) / \theta_{\text{JA}}$. All numbers apply for packages soldered directly into a PC board.

Note 5: Typical Values represent the most likely parametric norm.

Note 6: All limits are guaranteed by testing or statistical analysis.

Note 7: $V^+ = 5\text{V}$. Connected as voltage follower with 5V step input. Number specified is the slower of the positive and negative slew rates.

Note 8: Input referred, $V^+ = 5\text{V}$ and $R_L = 100\text{k}\Omega$ connected to 2.5V. Each amp excited in turn with 1kHz to produce $V_O = 3\text{V}_{\text{PP}}$.

Simplified Schematic

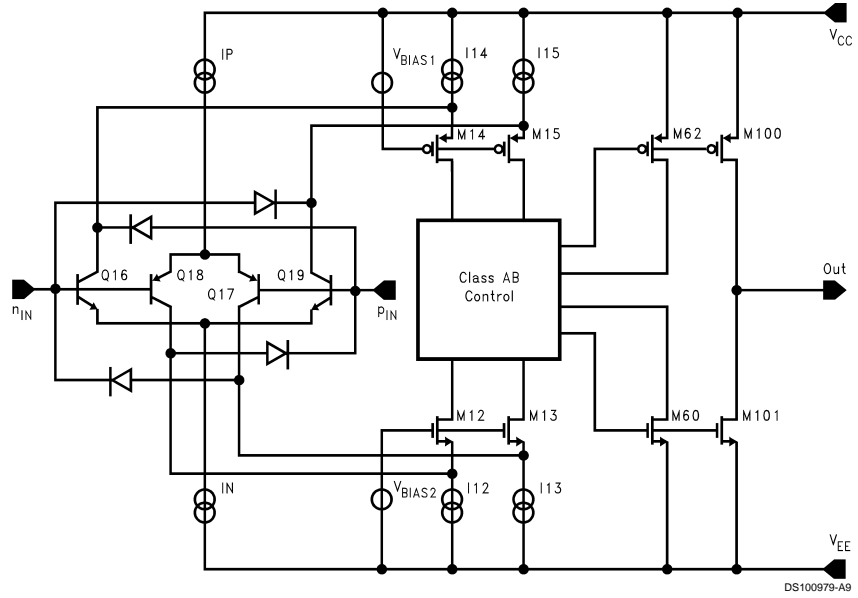

Typical Performance Characteristics Unless otherwise specified, $V_S = +5V$, single supply, $T_A = 25^\circ C$.

Supply Current vs. Supply Voltage (LMV921)

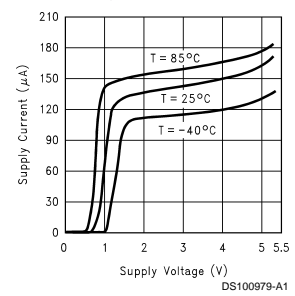

Input Bias Current vs. V_{CM}

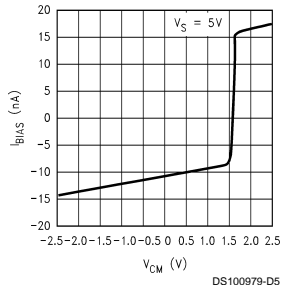

Sourcing Current vs. Output Voltage

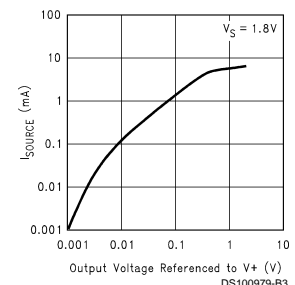

Sourcing Current vs. Output Voltage

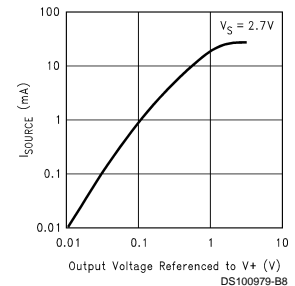

Sourcing Current vs. Output Voltage

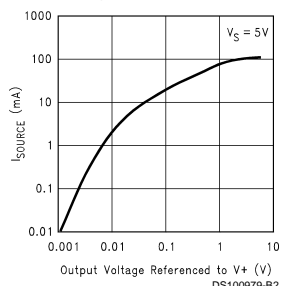

Sinking Current vs. Output Voltage

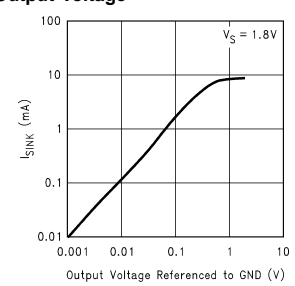

Sinking Current vs. Output Voltage

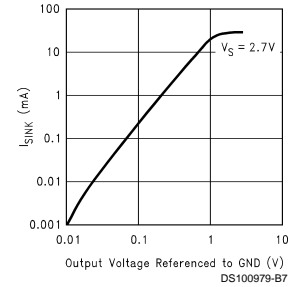

Sinking Current vs. Output Voltage

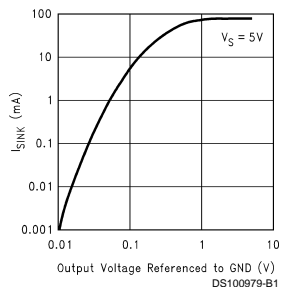

Offset Voltage vs. Common Mode Voltage

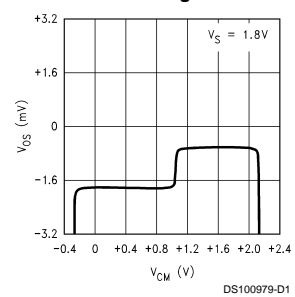

Typical Performance Characteristics Unless otherwise specified, $V_S = +5V$, single supply, $T_A = 25^\circ C$. (Continued)

Offset Voltage vs. Common Mode Voltage

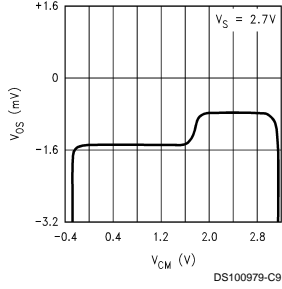

Offset Voltage vs. Common Mode Voltage

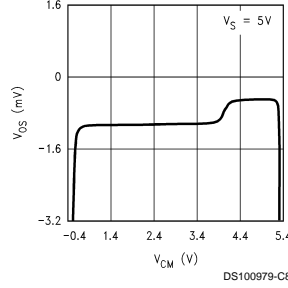

Output Voltage Swing vs. Supply Voltage

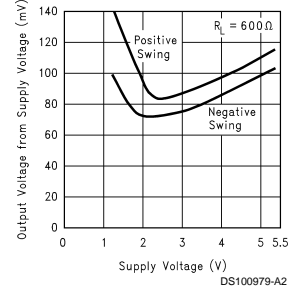

Output Voltage Swing vs. Supply Voltage

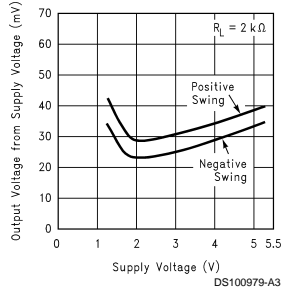

Gain and Phase Margin vs. Frequency

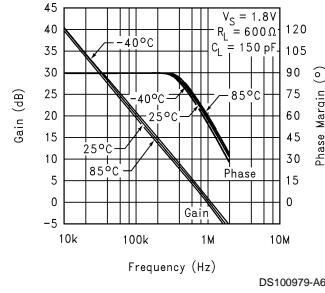

Gain and Phase Margin vs. Frequency

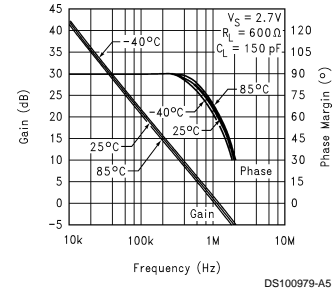

Gain and Phase Margin vs. Frequency

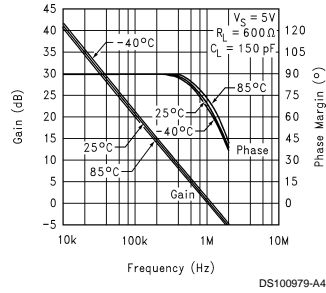

Gain and Phase Margin vs. Frequency

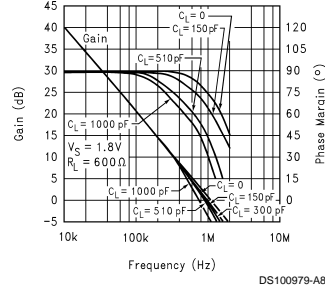

Gain and Phase Margin vs. Frequency

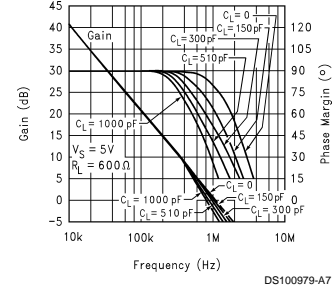

Typical Performance Characteristics Unless otherwise specified, $V_S = +5V$, single supply, $T_A = 25^\circ C$. (Continued)

CMRR vs. Frequency

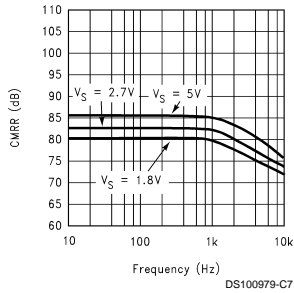

PSRR vs. Frequency

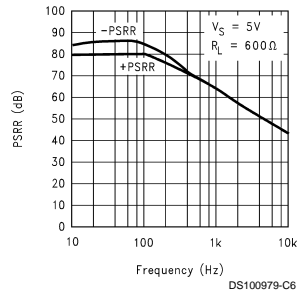

Input Voltage Noise vs. Frequency

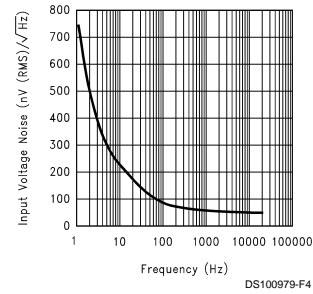

Input Current Noise vs. Frequency

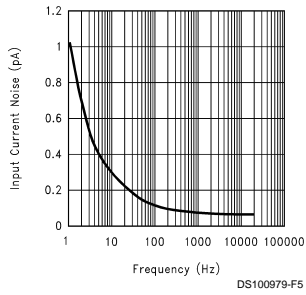

THD vs. Frequency

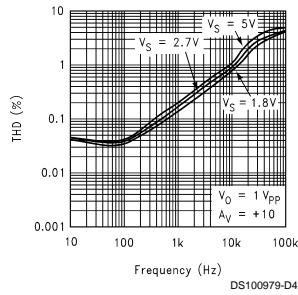

THD vs. Frequency

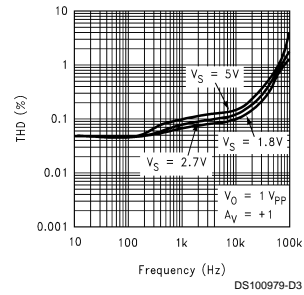

Slew Rate vs. Supply Voltage

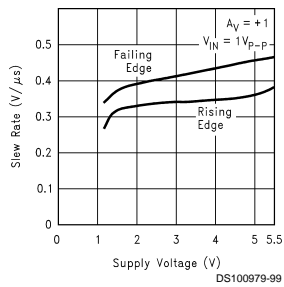

Small Signal Non-Inverting Response

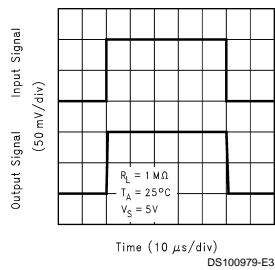

Small Signal Non-Inverting Response

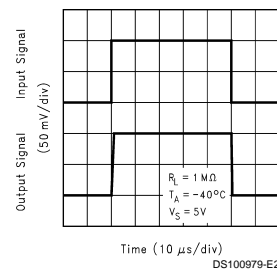

Typical Performance Characteristics Unless otherwise specified, $V_S = +5V$, single supply,
 $T_A = 25^\circ C$. (Continued)

Small Signal Non-Inverting Response

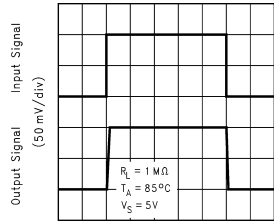

Time (10 μs /div)
 DS100979-E4

Small Signal Inverting Response

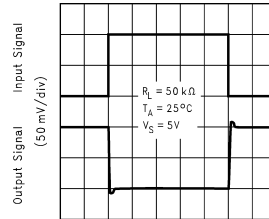

Time (10 μs /div)
 DS100979-E0

Small Signal Inverting Response

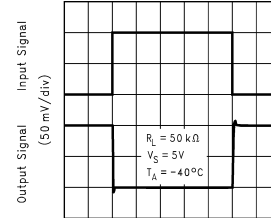

Time (10 μs /div)
 DS100979-D9

Small Signal Inverting Response

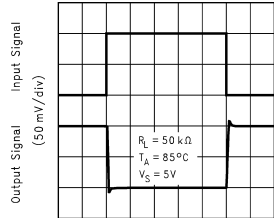

Time (10 μs /div)
 DS100979-D8

Small Signal Non-Inverting Response

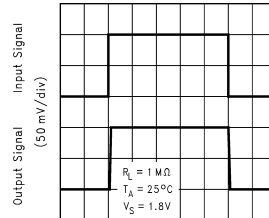

Time (10 μs /div)
 DS100979-E6

Small Signal Non-Inverting Response

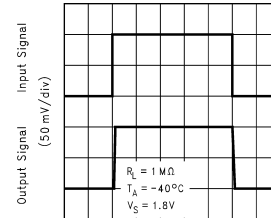

Time (10 μs /div)
 DS100979-E7

Small Signal Non-Inverting Response

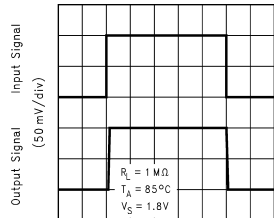

Time (10 μs /div)
 DS100979-E5

Small Signal Inverting Response

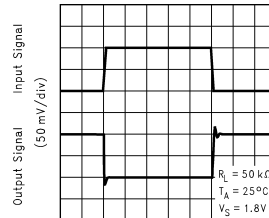

Time (10 μs /div)
 DS100979-G3

Small Signal Inverting Response

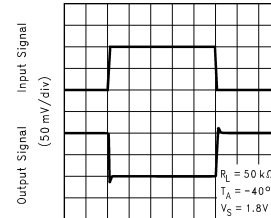

Time (10 μs /div)
 DS100979-G2

Typical Performance Characteristics Unless otherwise specified, $V_S = +5V$, single supply, $T_A = 25^\circ C$. (Continued)

Small Signal Inverting Response

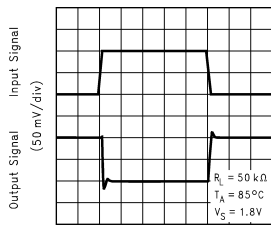

Time (10 μs /div)
DS100979-G1

***Large Signal Non-Inverting Response**

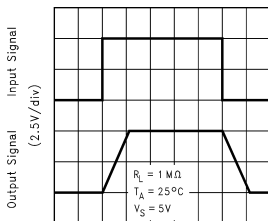

Time (10 μs /div)
DS100979-F0

***Large Signal Non-Inverting Response**

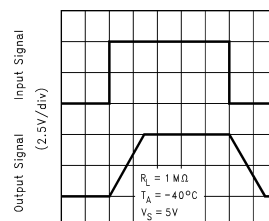

Time (10 μs /div)
DS100979-E9

***Large Signal Non-Inverting Response**

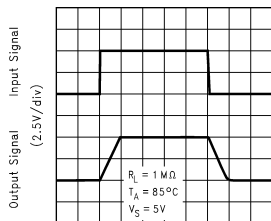

Time (10 μs /div)
DS100979-G0

***Large Signal Inverting Response**

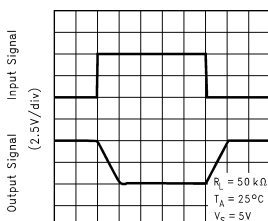

Time (10 μs /div)
DS100979-F9

***Large Signal Inverting Response**

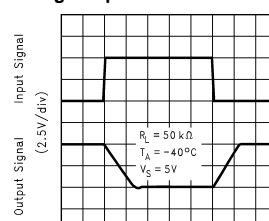

Time (10 μs /div)
DS100979-F8

***Large Signal Inverting Response**

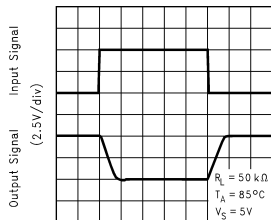

Time (10 μs /div)
DS100979-F7

***Large Signal Non-Inverting Response**

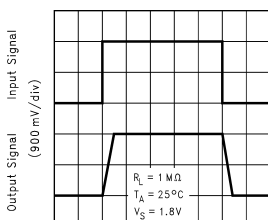

Time (10 μs /div)
DS100979-F1

***Large Signal Non-Inverting Response**

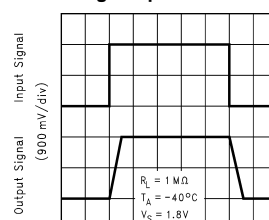

Time (10 μs /div)
DS100979-F2

*For large signal pulse response in the unity gain follower configuration, the input is 5mV below the positive rail and 5mV above the negative rail at 25°C and 85°C. At -40°C, input is 10mV below the positive rail and 10mV above the negative rail.

Typical Performance Characteristics Unless otherwise specified, $V_S = +5V$, single supply, $T_A = 25^\circ C$. (Continued)

***Large Signal Inverting Response**

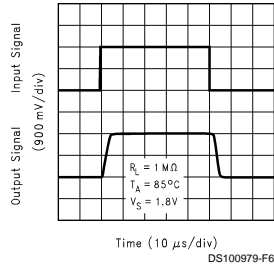

***Large Signal Inverting Response**

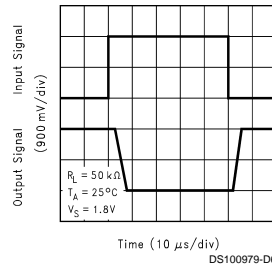

***Large Signal Inverting Response**

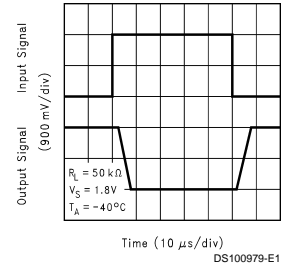

***Large Signal Inverting Response**

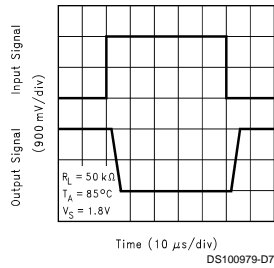

Short Circuit Current vs. Temperature (sinking)

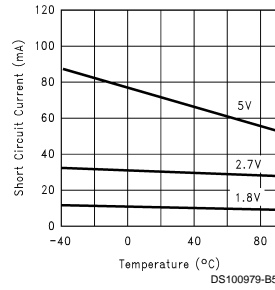

Short Circuit Current vs. Temperature (sourcing)

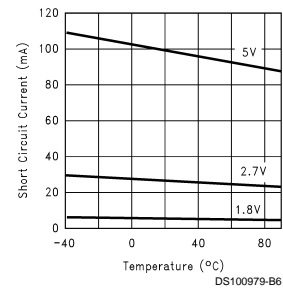

*For large signal pulse response in the unity gain follower configuration, the input is 5mV below the positive rail and 5mV above the negative rail at 25°C and 85°C. At -40°C, input is 10mV below the positive rail and 10mV above the negative rail.

Application Note

1.0 Unity Gain Pulse Response Considerations

The unity-gain follower is the most sensitive configuration to capacitive loading. The LMV921/LMV922/LMV924 family can directly drive 1nF in a unity-gain with minimal ringing. Direct capacitive loading reduces the phase margin of the amplifier. The combination of the amplifier's output impedance and the capacitive load induces phase lag. This results in either an underdamped pulse response or oscillation. The pulse response can be improved by adding a pull up resistor as shown in *Figure 1*

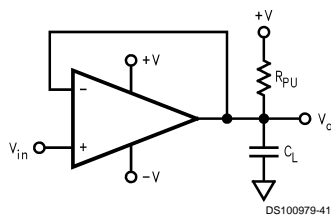

FIGURE 1. Using a Pull-Up Resistor at the Output for Stabilizing Capacitive Loads

Higher capacitances can be driven by decreasing the value of the pull-up resistor, but its value shouldn't be reduced beyond the sinking capability of the part. An alternate approach is to use an isolation resistor as illustrated in *Figure 2*.

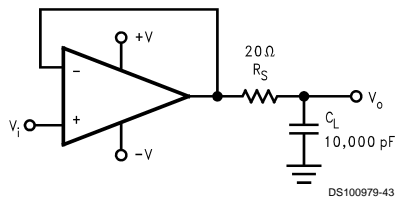

FIGURE 2. Using an Isolation Resistor to Drive Heavy Capacitive Loads

2.0 Input Bias Current Consideration

The LMV921/LMV922/LMV924 family has a bipolar input stage. The typical input bias current (I_B) is 12nA. The input bias current can develop a significant offset voltage. This offset is primarily due to I_B flowing through the negative feedback resistor, R_F . For example, if I_B is 50nA (max room) and R_F is 100k Ω , then an offset voltage of 5mV will develop ($V_{OS} = I_B \times R_F$). Using a compensation resistor (R_C), as shown in *Figure 3*, cancels this affect. But the input offset current (I_{OS}) will still contribute to an offset voltage in the same manner.

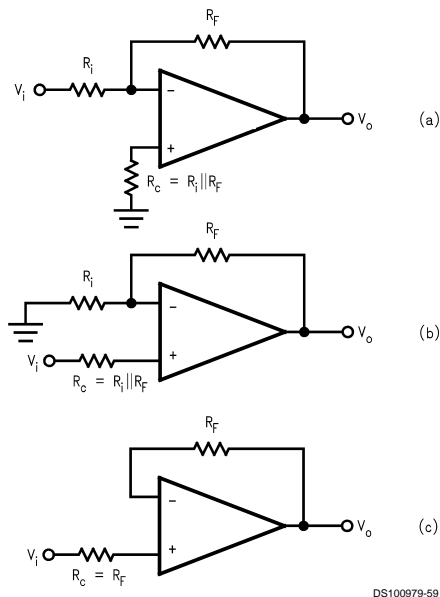

FIGURE 3. Canceling the Voltage Offset Effect of Input Bias Current

3.0 Operating Supply Voltage

The LMV921/LMV922/LMV924 family is guaranteed to operate from 1.8V to 5.0V. They will begin to function at power voltages as low as 1.2V at room temperature when unloaded. Start up voltage increases to 1.5V when the amplifier is fully loaded (600 Ω to mid-supply). Below 1.2V the output voltage is not guaranteed to follow the input. *Figure 4* below shows the output voltage vs. supply voltage with the LMV921/LMV922/LMV924 configured as a voltage follower at room temperature.

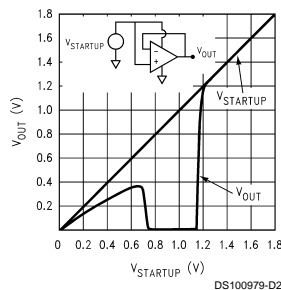

FIGURE 4.

4.0 Input and Output Stage

The rail-to-rail input stage of this family provides more flexibility for the designer. The LMV921/LMV922/LMV924 use a complimentary PNP and NPN input stage in which the PNP stage senses common mode voltage near V^- and the NPN stage senses common mode voltage near V^+ . The transition from the PNP stage to NPN stage occurs 1V below V^+ . Since both input stages have their own offset voltage, the offset of the amplifier becomes a function of the input common mode voltage and has a crossover point at 1V below V^+ as shown in the V_{OS} vs. V_{CM} curves.

Application Note (Continued)

This V_{OS} crossover point can create problems for both DC and AC coupled signals if proper care is not taken. For large input signals that include the V_{OS} crossover point in their dynamic range, this will cause distortion in the output signal. One way to avoid such distortion is to keep the signal away from the crossover. For example, in a unity gain buffer configuration and with $V_S = 5V$, a 5V peak-to-peak signal will contain input-crossover distortion while a 3V peak-to-peak signal centered at 1.5V will not contain input-crossover distortion as it avoids the crossover point. Another way to avoid large signal distortion is to use a gain of -1 circuit which avoids any voltage excursions at the input terminals of the amplifier. In that circuit, the common mode DC voltage can be set at a level away from the V_{OS} cross-over point.

For small signals, this transition in V_{OS} shows up as a V_{CM} dependent spurious signal in series with the input signal and can effectively degrade small signal parameters such as gain and common mode rejection ratio. To resolve this problem, the small signal should be placed such that it avoids the V_{OS} crossover point.

In addition to the rail-to-rail performance, the output stage can provide enough output current to drive 600 Ω loads. Because of the high current capability, care should be taken not to exceed the 150°C maximum junction temperature specification.

5.0 Power-Supply Considerations

The LMV921/LMV922/LMV924 are ideally suited for use with most battery-powered systems. The LMV921/LMV922/LMV924 operate from a single +1.8V to +5.0V supply and consumes about 145 μ A of supply current per Amplifier. A

high power supply rejection ratio of 78dB allows the amplifier to be powered directly off a decaying battery voltage extending battery life.

Table 1 lists a variety of typical battery types. Batteries have different voltage ratings; operating voltage is the battery voltage under nominal load. End-of-Life voltage is defined as the voltage at which 100% of the usable power of the battery is consumed. Table 1 also shows the typical operating time of the LMV921.

6.0 Distortion

The two main contributors of distortion in LMV921/LMV922/LMV924 family is:

1. Output crossover distortion occurs as the output transitions from sourcing current to sinking current.
2. Input crossover distortion occurs as the input switches from NPN to PNP transistor at the input stage.

To decrease crossover distortion:

1. Increase the load resistance. This lowers the output crossover distortion but has no effect on the input crossover distortion.
2. Operate from a single supply with the output always sourcing current.
3. Limit the input voltage swing for large signals between ground and one volt below the positive supply.
4. Operate in inverting configuration to eliminate common mode induced distortion.
5. Avoid small input signal around the input crossover region. The discontinuity in the offset voltage will effect the gain, CMRR and PSRR.

TABLE 1. LMV921 Characteristics with Typical Battery Systems.

Battery Type	Operating Voltage (V)	End-of-Life Voltage (V)	Capacity AA Size (mA - h)	LMV921 Operating time (Hours)
Alkaline	1.5	0.9	1000	6802
Lithium	2.7	2.0	1000	6802
Ni - Cad	1.2	0.9	375	2551
NMH	1.2	1.0	500	3401

Typical Applications

1.0 Half-wave Rectifier with Rail-To-Ground Output Swing

Since the LMV921 input common mode range includes both positive and negative supply rails and the output can also swing to either supply, achieving half-wave rectifier functions in either direction is an easy task. All that is needed are two external resistors; there is no need for diodes or matched resistors. The half wave rectifier can have either positive or negative going outputs, depending on the way the circuit is arranged.

In *Figure 5* the circuit is referenced to ground, while in *Figure 6* the circuit is biased to the positive supply. These configurations implement the half wave rectifier since the LMV921 can not respond to one-half of the incoming waveform. It can not respond to one-half because the amplifier can not swing the output beyond either rail therefore the output disengages during this half cycle. During the other half cycle, however, the amplifier achieves a half wave that can have a peak equal to the total supply voltage. R_1 should be large enough not to load the LMV921.

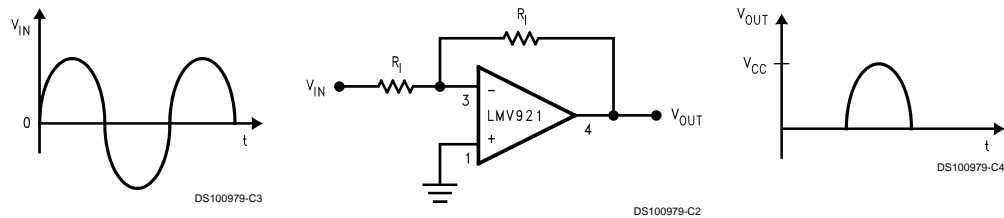

FIGURE 5. Half-Wave Rectifier with Rail-To-Ground Output Swing Referenced to Ground

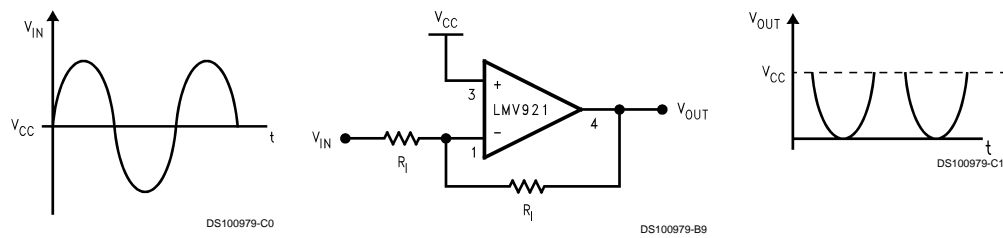

FIGURE 6. Half-Wave Rectifier with Negative-Going Output Referenced to V_{CC}

Typical Applications (Continued)

2.0 Instrumentation Amplifier with Rail-To-Rail Input and Output

Using three of the LMV924 Amplifiers, an instrumentation amplifier with rail-to-rail inputs and outputs can be made.

Some manufacturers use a precision voltage divider array of 5 resistors to divide the common mode voltage to get a rail-to-rail input range. The problem with this method is that it also divides the signal, so in order to get unity gain, the amplifier must be run at high loop gains. This raises the noise and drift by the internal gain factor and lowers the input impedance. Any mismatch in these precision resistors reduces the CMRR as well. Using the LMV924 eliminates all of these problems.

In this example, amplifiers A and B act as buffers to the differential stage. These buffers assure that the input imped-

ance is very high and require no precision matched resistors in the input stage. They also assure that the difference amp is driven from a voltage source. This is necessary to maintain the CMRR set by the matching R_1 - R_2 with R_3 - R_4 .

The gain is set by the ratio of R_2/R_1 and R_3 should equal R_1 and R_4 equal R_2 .

With both rail-to-rail input and output ranges, the input and output are only limited by the supply voltages. Remember that even with rail-to-rail outputs, the output can not swing past the supplies so the combined common mode voltages plus the signal should not be greater than the supplies or limiting will occur. For additional applications, see National Semiconductor application notes AN-29, AN-31, AN-71, and AN-127.

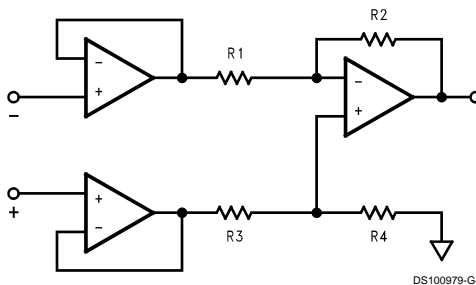
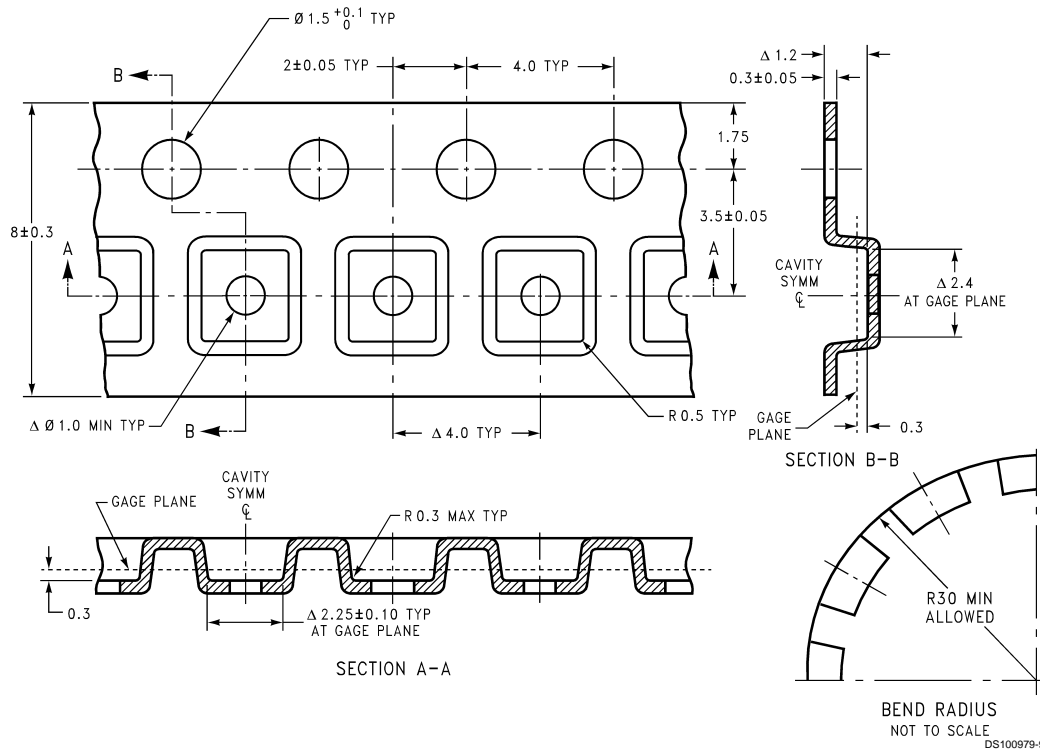

FIGURE 7. Rail-to-rail instrumentation amplifier

DS100979-G4

SC70-5 Tape Dimensions



SOT23-5 and SC70-5 Tape Format

Tape Format

Tape Section	# Cavities	Cavity Status	Cover Tape Status
Leader (Start End)	0 (min)	Empty	Sealed
	75 (min)	Empty	Sealed
Carrier	3000	Filled	Sealed
	250	Filled	Sealed
Trailer (Hub End)	125 (min)	Empty	Sealed
	0 (min)	Empty	Sealed

SOT23-5 Tape Dimensions

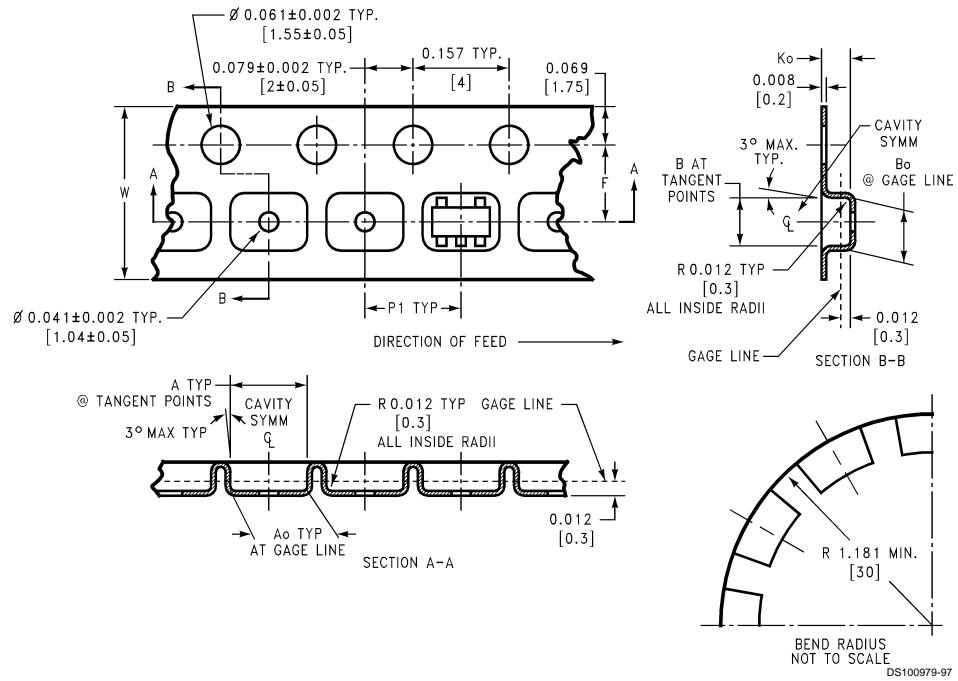

8 mm	0.130	0.124	0.130	0.126	0.138 ±0.002	0.055 ±0.004	0.157	0.315 ±0.012
	(3.3)	(3.15)	(3.3)	(3.2)	(3.5 ±0.05)	(1.4 ±0.11)	(4)	(8 ±0.3)
Tape Size	DIM A	DIM A _o	DIM B	DIM B _o	DIM F	DIM K _o	DIM P ₁	DIM W

SOT23-5 and SC70-5 Reel Dimensions

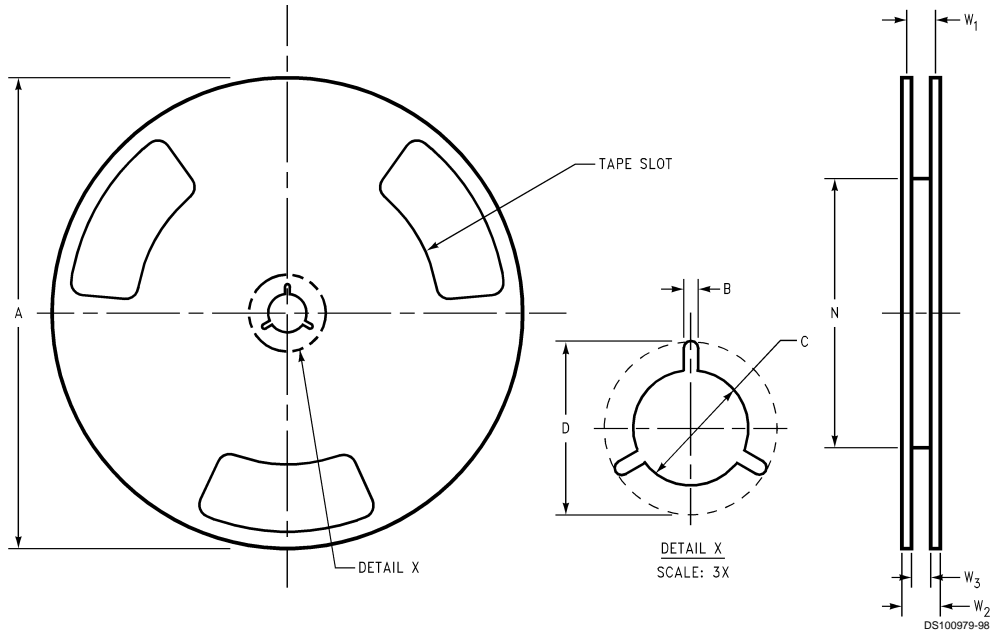

8 mm	7.00	0.059	0.512	0.795	2.165	$0.331 + 0.059/-0.000$	0.567	$W1 + 0.078/-0.039$
	330.00	1.50	13.00	20.20	55.00	$8.40 + 1.50/-0.00$	14.40	$W1 + 2.00/-1.00$
Tape Size	A	B	C	D	N	W1	W2	W3

LMV921 Single/ LMV922 Dual/ LMV924 Quad

Physical Dimensions inches (millimeters) unless otherwise noted

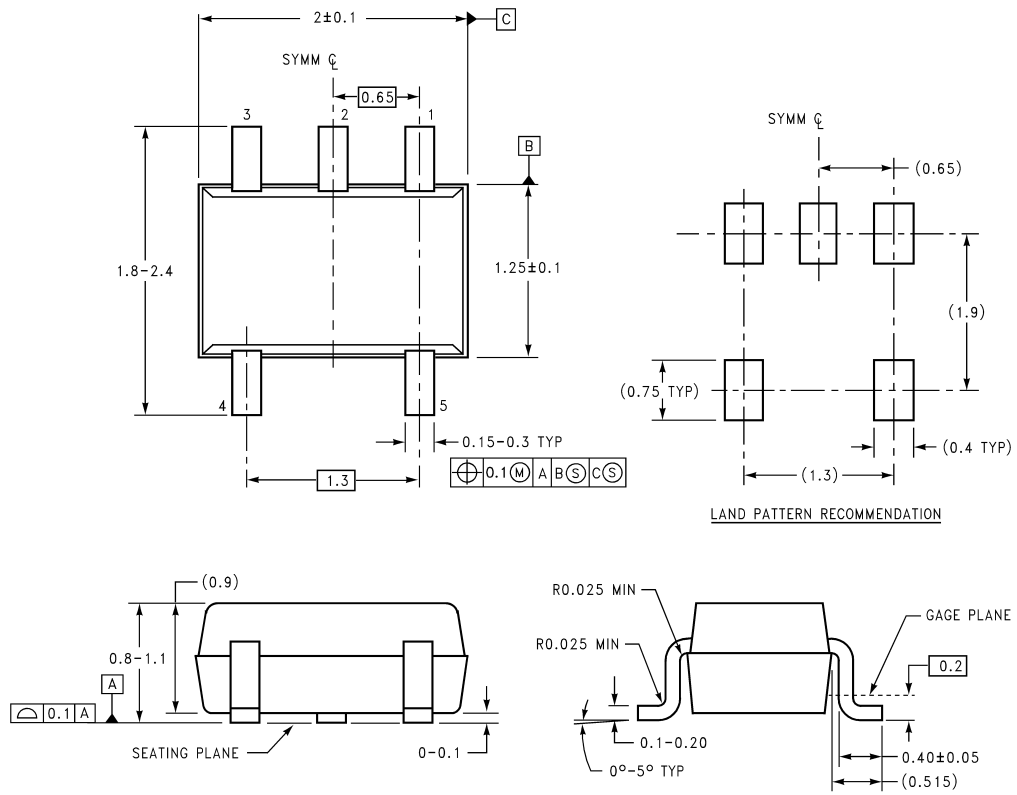

DIMENSIONS ARE IN MILLIMETERS

MAA05A (REV B)

SC70-5
Order Number LMV921M7 or LMV921M7X
NS Package Number MAA05A

Physical Dimensions inches (millimeters) unless otherwise noted (Continued)

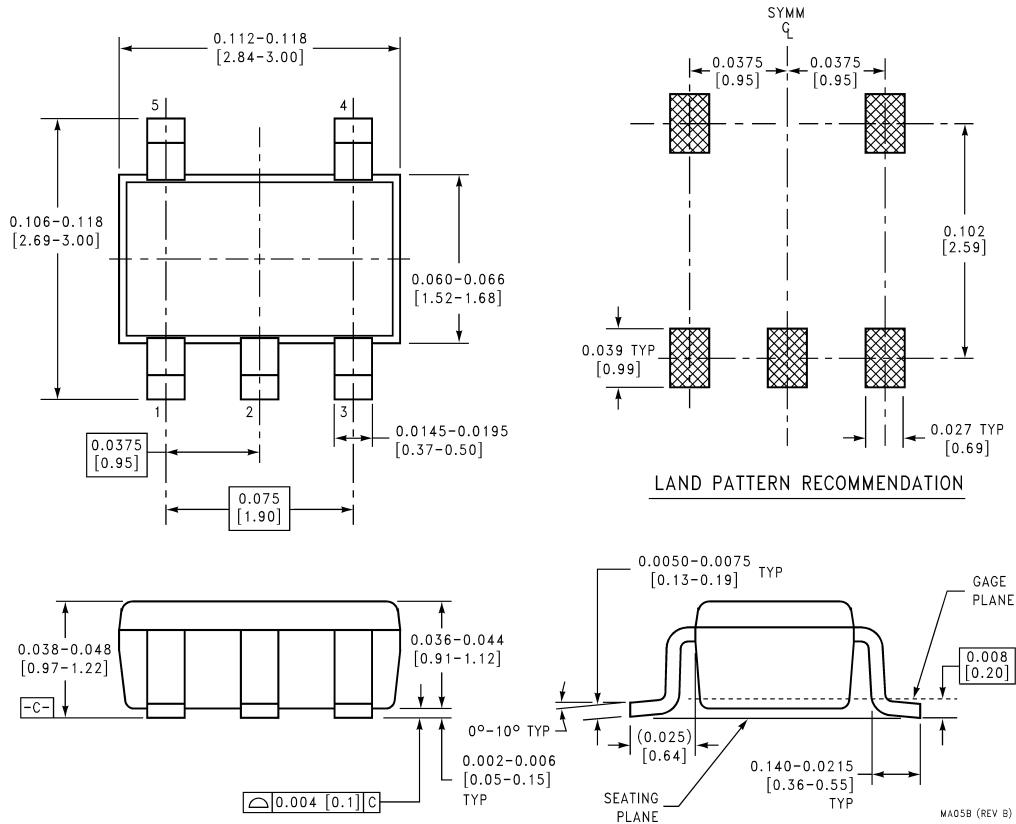

SOT 23-5
Order Number LMV921M5 or LMV921M5X
NS Package Number MA05B

Physical Dimensions inches (millimeters) unless otherwise noted (Continued)

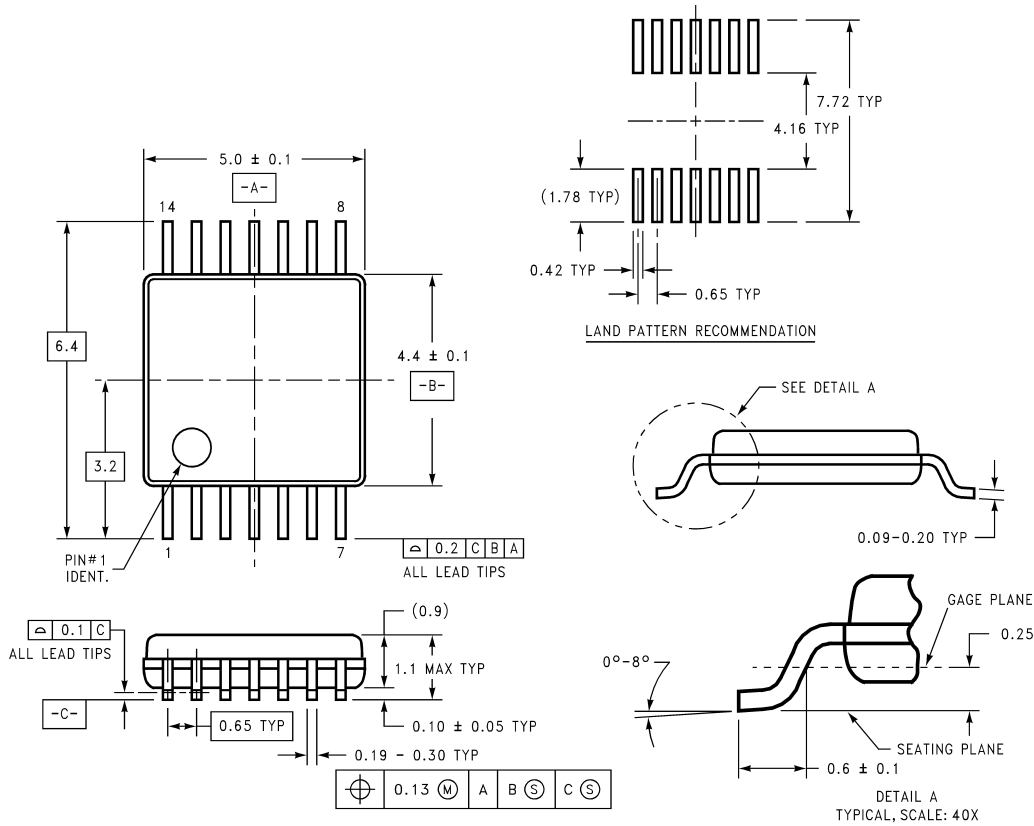

DIMENSIONS ARE IN MILLIMETERS

MTC14 (REV C)

14-Pin TSSOP
Order Number LMV924MT or LMV924MTX
NS Package Number MTC14

Physical Dimensions inches (millimeters) unless otherwise noted (Continued)

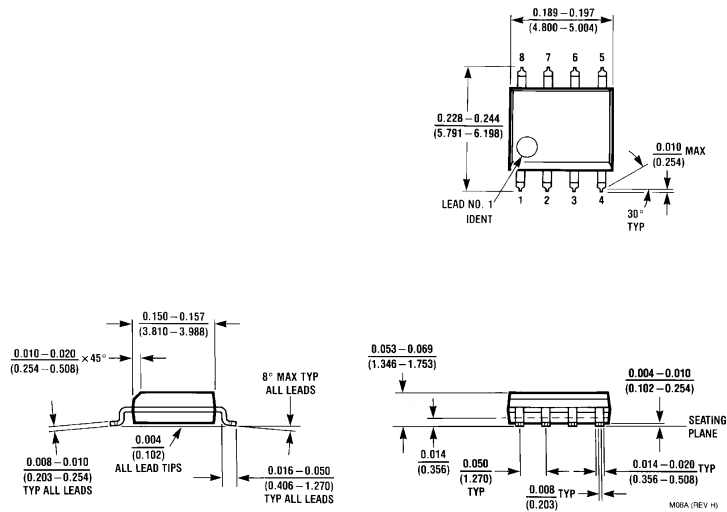

8-Pin SOIC
Order Number LMV922M or LMV922MX
NS Package Number M08A

Physical Dimensions inches (millimeters) unless otherwise noted (Continued)

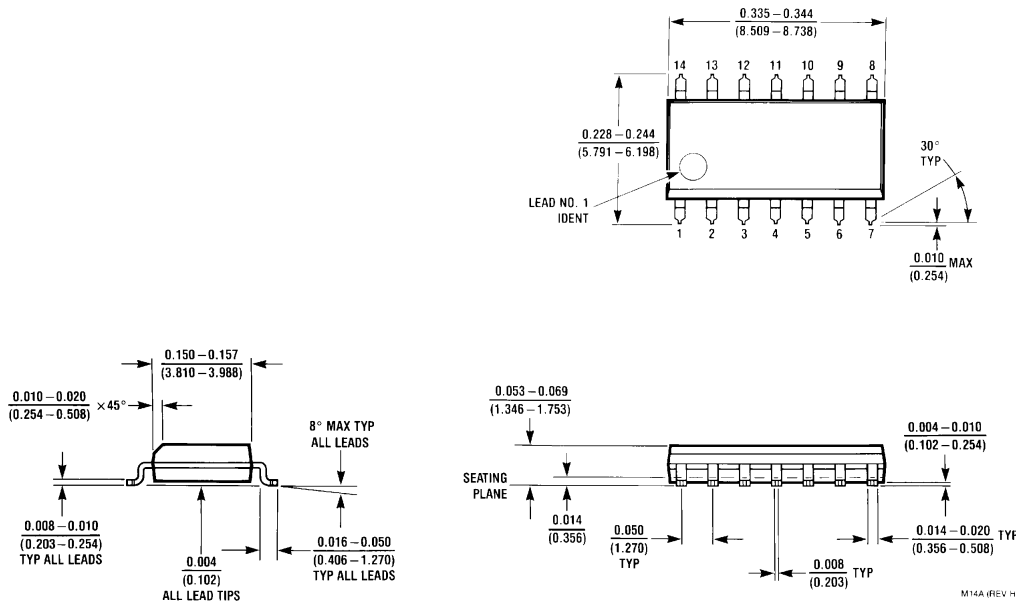

14-Pin SOIC
Order Number LMV924M or LMV924MX
NS Package Number MA14

LIFE SUPPORT POLICY

NATIONAL'S PRODUCTS ARE NOT AUTHORIZED FOR USE AS CRITICAL COMPONENTS IN LIFE SUPPORT DEVICES OR SYSTEMS WITHOUT THE EXPRESS WRITTEN APPROVAL OF THE PRESIDENT AND GENERAL COUNSEL OF NATIONAL SEMICONDUCTOR CORPORATION. As used herein:

1. Life support devices or systems are devices or systems which, (a) are intended for surgical implant into the body, or (b) support or sustain life, and whose failure to perform when properly used in accordance with instructions for use provided in the labeling, can be reasonably expected to result in a significant injury to the user.
2. A critical component is any component of a life support device or system whose failure to perform can be reasonably expected to cause the failure of the life support device or system, or to affect its safety or effectiveness.

National Semiconductor Corporation
 Americas
 Tel: 1-800-272-9959
 Fax: 1-800-737-7018
 Email: support@nsc.com
 www.national.com

National Semiconductor Europe
 Fax: +49 (0) 1 80-530 85 86
 Email: europe.support@nsc.com
 Deutsch Tel: +49 (0) 1 80-530 85 85
 English Tel: +49 (0) 1 80-532 78 32
 Français Tel: +49 (0) 1 80-532 93 58
 Italiano Tel: +49 (0) 1 80-534 16 80

National Semiconductor Asia Pacific Customer Response Group
 Tel: 65-2544466
 Fax: 65-2504466
 Email: sea.support@nsc.com

National Semiconductor Japan Ltd.
 Tel: 81-3-5639-7560
 Fax: 81-3-5639-7507

National does not assume any responsibility for use of any circuitry described, no circuit patent licenses are implied and National reserves the right at any time without notice to change said circuitry and specifications.