

LPV321 Single/ LPV358 Dual/ LPV324 Quad General Purpose, Low Voltage, Low Power, Rail-to-Rail Output Operational Amplifiers

General Description

The LPV321/358/324 are low power (9µA per channel at 5.0V) versions of the LMV321/358/324 op amps. This is another addition to the LMV321/358/324 family of commodity op amps.

The LPV321/358/324 are the most cost effective solutions for the applications where low voltage, low power operation, space saving and low price are needed. The LPV321/358/324 have rail-to-rail output swing capability and the input common-mode voltage range includes ground. They all exhibit excellent speed-power ratio, achieving 152 KHz of bandwidth with a supply current of only 9µA.

The LPV321 is available in space saving SC70-5, which is approximately half the size of SOT23-5. The small package saves space on pc boards, and enables the design of small portable electronic devices. It also allows the designer to place the device closer to the signal source to reduce noise pickup and increase signal integrity.

The chips are built with National's advanced submicron silicon-gate BiCMOS process. The LPV321/358/324 have bipolar input and output stages for improved noise performance and higher output current drive.

Features

(For $V^+ = 5V$ and $V^- = 0V$, Typical Unless Otherwise Noted)

- Guaranteed 2.7V and 5V Performance
- No Crossover Distortion
- Space Saving Package

SC70-5	2.0x2.1x1.0mm
--------	---------------
- Industrial Temp. Range

-40°C to +85°C

- Gain-Bandwidth Product

152KHz

- Low Supply Current

LPV321	9µA
LPV358	15µA
LPV324	28µA
- Rail-to-Rail Output Swing

@ 100kΩ Load	$V^+ - 3.5mV$
	$V^- + 90mV$
- V_{CM}

-0.2V to $V^+ - 0.8V$

Applications

- Active Filters
- General Purpose Low Voltage Applications
- General Purpose Portable Devices

Connection Diagrams

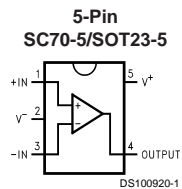

Top View

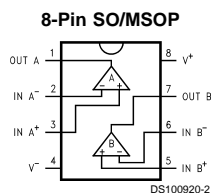

Top View

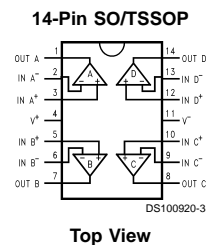

Top View

LPV321 Single/ LPV358 Dual/ LPV324 Quad General Purpose, Low Voltage, Low Power, Rail-to-Rail Output Operational Amplifiers

Ordering Information

Package	Temperature Range	Packaging Marking	Transport Media	NSC Drawing
	Industrial -40°C to +85°C			
5-Pin SC70-5	LPV321M7	A19	1k Units Tape and Reel	MAA05
	LPV321M7X	A19	3k Units Tape and Reel	
5-Pin SOT23-5	LPV321M5	A27A	1k Units Tape and Reel	MA05B
	LPV321M5X	A27A	3k Units Tape and Reel	
8-Pin Small Outline	LPV358M	LPV358M	Rails	M08A
	LPV358MX	LPV358M	2.5k Units Tape and Reel	
8-Pin MSOP	LPV358MM	P358	1k Units Tape and Reel	MUA08A
	LPV358MMX	P358	3.5k Units Tape and Reel	
14-Pin Small Outline	LPV324M	LPV324M	Rails	M14A
	LPV324MX	LPV324M	2.5k Units Tape and Reel	
14-Pin TSSOP	LPV324MT	LPV324MT	Rails	MTC14
	LPV324MTX	LPV324MT	2.5k Units Tape and Reel	

Absolute Maximum Ratings (Note 1)

If Military/Aerospace specified devices are required, please contact the National Semiconductor Sales Office/ Distributors for availability and specifications.

ESD Tolerance (Note 2)	
Machine Model	100V
Human Body Model	2000V
Differential Input Voltage	± Supply Voltage
Supply Voltage (V ⁺ -V ⁻)	5.5V
Output Short Circuit to V ⁺	(Note 3)
Output Short Circuit to V ⁻	(Note 4)
Soldering Information	
Infrared or Convection (20 sec)	235°C
Storage Temp. Range	-65°C to 150°C

Junction Temp. (T_J, max) (Note 5)

150°C

Operating Ratings (Note 1)

Supply Voltage	2.7V to 5V
Temperature Range	-40°C ≤ T _J ≤ 85°C
Thermal Resistance (θ _{JA})(Note 10)	
5-pin SC70-5	478°C/W
5-pin SOT23-5	265°C/W
8-Pin SOIC	190°C/W
8-Pin MSOP	235°C/W
14-Pin SOIC	145°C/W
14-Pin TSSOP	155°C/W

2.7V DC Electrical Characteristics

Unless otherwise specified, all limits guaranteed for T_J = 25°C, V⁺ = 2.7V, V⁻ = 0V, V_{CM} = 1.0V, V_O = V⁺/2 and R_L > 1 MΩ.

Symbol	Parameter	Conditions	Typ (Note 6)	Limit (Note 7)	Units
V _{OS}	Input Offset Voltage		1.2	7	mV max
TCV _{OS}	Input Offset Voltage Average Drift		2		µV/°C
I _B	Input Bias Current		1.7	50	nA max
I _{OS}	Input Offset Current		0.6	40	nA max
CMRR	Common Mode Rejection Ratio	0V ≤ V _{CM} ≤ 1.7V	70	50	dB min
PSRR	Power Supply Rejection Ratio	2.7V ≤ V ⁺ ≤ 5V V _O = 1V, V _{CM} = 1V	65	50	dB min
V _{CM}	Input Common-Mode Voltage Range	For CMRR ≥ 50dB	-0.2	0	V min
			1.9	1.7	V max
V _O	Output Swing	R _L = 100kΩ to 1.35V	V ⁺ -3	V ⁺ -100	mV min
			80	180	mV max
I _S	Supply Current	LPV321	4	8	µA max
		LPV358 Both amplifiers	8	16	µA max
		LPV324 All four amplifiers	16	24	µA max

2.7V AC Electrical Characteristics

Unless otherwise specified, all limits guaranteed for $T_J = 25^\circ\text{C}$, $V^+ = 2.7\text{V}$, $V^- = 0\text{V}$, $V_{\text{CM}} = 1.0\text{V}$, $V_O = V^+/2$ and $R_L > 1\text{M}\Omega$.

Symbol	Parameter	Conditions	Typ (Note 6)	Limit (Note 7)	Units
GBWP	Gain-Bandwidth Product	$C_L = 22\text{pF}$	112		KHz
Φ_m	Phase Margin		97		Deg
G_m	Gain Margin		35		dB
e_n	Input-Referred Voltage Noise	$f = 1\text{kHz}$	178		$\frac{\text{nV}}{\sqrt{\text{Hz}}}$
i_n	Input-Referred Current Noise	$f = 1\text{kHz}$	0.50		$\frac{\text{pA}}{\sqrt{\text{Hz}}}$

5V DC Electrical Characteristics

Unless otherwise specified, all limits guaranteed for $T_J = 25^\circ\text{C}$, $V^+ = 5\text{V}$, $V^- = 0\text{V}$, $V_{\text{CM}} = 2.0\text{V}$, $V_O = V^+/2$ and $R_L > 1\text{M}\Omega$.
Boldface limits apply at the temperature extremes.

Symbol	Parameter	Conditions	Typ (Note 6)	Limit (Note 7)	Units
V_{OS}	Input Offset Voltage		1.5	7 10	mV max
TCV_{OS}	Input Offset Voltage Average Drift		2		$\mu\text{V}/^\circ\text{C}$
I_B	Input Bias Current		2	50 60	nA max
I_{OS}	Input Offset Current		0.6	40 50	nA max
CMRR	Common Mode Rejection Ratio	$0\text{V} \leq V_{\text{CM}} \leq 4\text{V}$	71	50	dB min
PSRR	Power Supply Rejection Ratio	$2.7\text{V} \leq V^+ \leq 5\text{V}$ $V_O = 1\text{V}$, $V_{\text{CM}} = 1\text{V}$	65	50	dB min
V_{CM}	Input Common-Mode Voltage Range	For CMRR $\geq 50\text{dB}$	-0.2 4.2	0 4	V min V max
A_V	Large Signal Voltage Gain (Note 8)	$R_L = 100\text{k}\Omega$	100	15 10	V/mV min
V_O	Output Swing	$R_L = 100\text{k}\Omega$ to 2.5V	$V^+ - 3.5$ 90	$V^+ - 100$ $V^+ - 200$ 180 220	mV min mV max
I_O	Output Short Circuit Current	Sourcing, $V_O = 0\text{V}$ Sinking, $V_O = 5\text{V}$	17 72	2 20	mA min mA min
I_S	Supply Current	LPV321 LPV358 Both amplifiers LPV324 All four amplifiers	9 15 28	12 15 20 24 42 46	μA max μA max μA max

5V AC Electrical Characteristics

Unless otherwise specified, all limits guaranteed for $T_J = 25^\circ\text{C}$, $V^+ = 5\text{V}$, $V^- = 0\text{V}$, $V_{\text{CM}} = 2.0\text{V}$, $V_O = V^+/2$ and $R_L > 1\text{M}\Omega$. **Boldface** limits apply at the temperature extremes.

Symbol	Parameter	Conditions	Typ (Note 6)	Limit (Note 7)	Units
SR	Slew Rate	(Note 9)	0.1		V/ μs
GBWP	Gain-Bandwidth Product	$C_L = 22\text{ pF}$	152		KHz
Φ_m	Phase Margin		87		Deg
G_m	Gain Margin		19		dB
e_n	Input-Referred Voltage Noise	$f = 1\text{ kHz}$,	146		$\frac{\text{nV}}{\sqrt{\text{Hz}}}$
i_n	Input-Referred Current Noise	$f = 1\text{ kHz}$	0.30		$\frac{\text{pA}}{\sqrt{\text{Hz}}}$

Note 1: Absolute Maximum Ratings indicate limits beyond which damage to the device may occur. Operating Ratings indicate conditions for which the device is intended to be functional, but specific performance is not guaranteed. For guaranteed specifications and the test conditions, see the Electrical Characteristics.

Note 2: Human body model, 1.5 k Ω in series with 100 pF. Machine model, 0 Ω in series with 200 pF.

Note 3: Shorting output to V^+ will adversely affect reliability.

Note 4: Shorting output to V^- will adversely affect reliability.

Note 5: The maximum power dissipation is a function of $T_{J(\text{max})}$, θ_{JA} , and T_A . The maximum allowable power dissipation at any ambient temperature is $P_D = (T_{J(\text{max})} - T_A) / \theta_{JA}$. All numbers apply for packages soldered directly into a PC board.

Note 6: Typical values represent the most likely parametric norm.

Note 7: All limits are guaranteed by testing or statistical analysis.

Note 8: R_L is connected to V^- . The output voltage is $0.5\text{V} \leq V_O \leq 4.5\text{V}$.

Note 9: Connected as voltage follower with 3V step input. Number specified is the slower of the positive and negative slew rates.

Note 10: All numbers are typical, and apply for packages soldered directly onto a PC board in still air.

Typical Performance Characteristics Unless otherwise specified, $V_S = +5V$, single supply, $T_A = 25^\circ C$.

Supply Current vs Supply Voltage (LPV321)

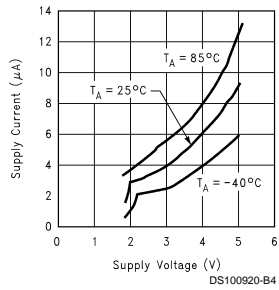

Input Current vs Temperature

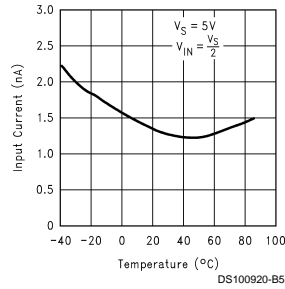

Sourcing Current vs Output Voltage

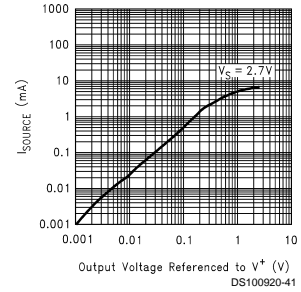

Sourcing Current vs Output Voltage

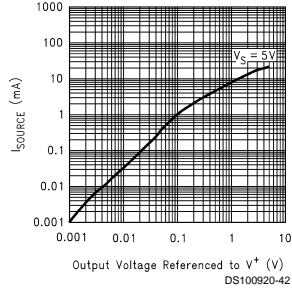

Sinking Current vs Output Voltage

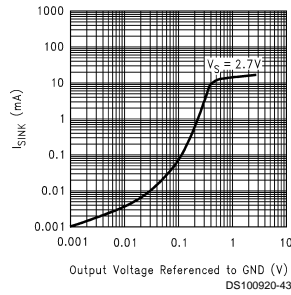

Sinking Current vs Output Voltage

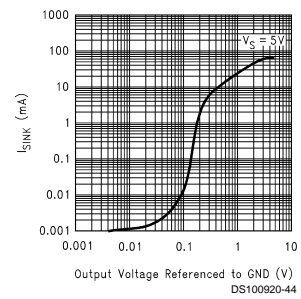

Output Voltage Swing vs Supply Voltage

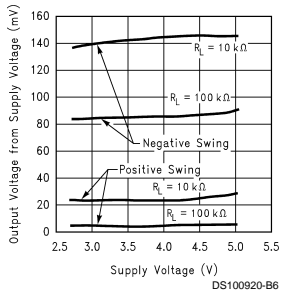

Input Voltage Noise vs Frequency

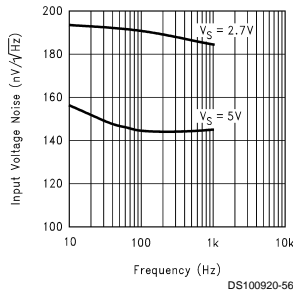

Input Current Noise vs Frequency

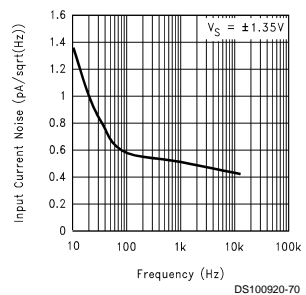

Typical Performance Characteristics Unless otherwise specified, $V_S = +5V$, single supply, $T_A = 25^\circ C$. (Continued)

Input Current Noise vs Frequency

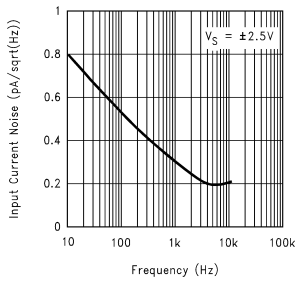

DS100920-68

Crosstalk Rejection vs Frequency

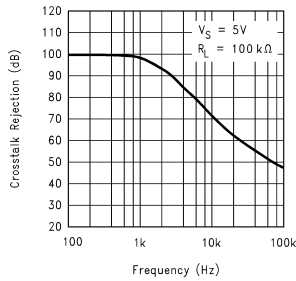

DS100920-73

PSRR vs Frequency

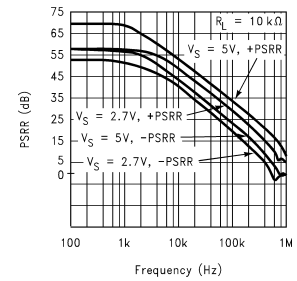

DS100920-72

CMRR vs Frequency

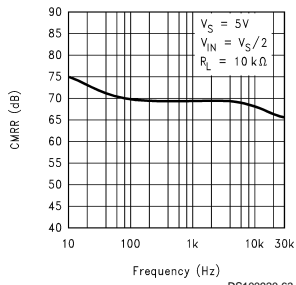

DS100920-63

CMRR vs Input Common Mode Voltage

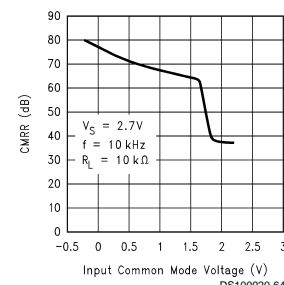

DS100920-64

CMRR vs Input Common Mode Voltage

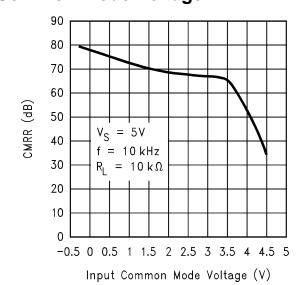

DS100920-65

ΔV_{OS} vs CMR

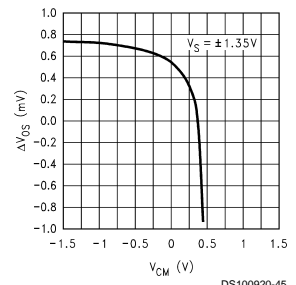

DS100920-45

ΔV_{OS} vs CMR

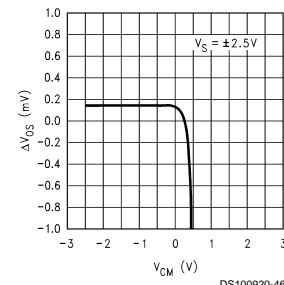

DS100920-46

Input Voltage vs Output Voltage

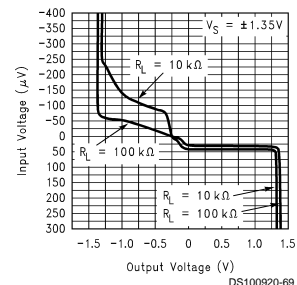

DS100920-69

Typical Performance Characteristics Unless otherwise specified, $V_S = +5V$, single supply, $T_A = 25^\circ C$. (Continued)

Input Voltage vs Output Voltage

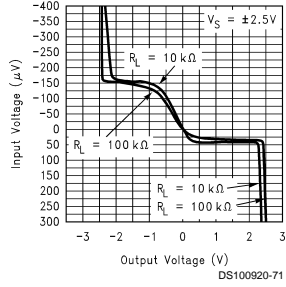

Open Loop Frequency Response

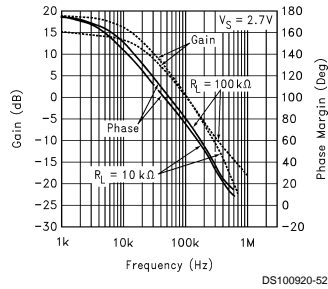

Open Loop Frequency Response

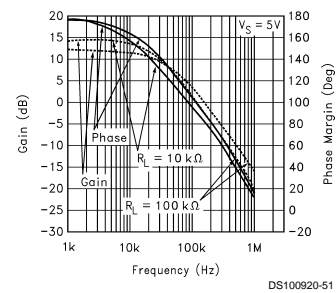

Gain and Phase vs Capacitive Load

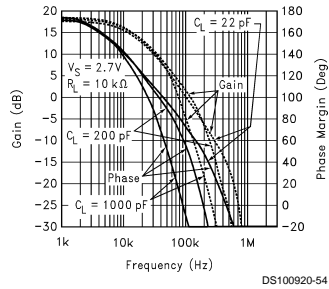

Gain and Phase vs Capacitive Load

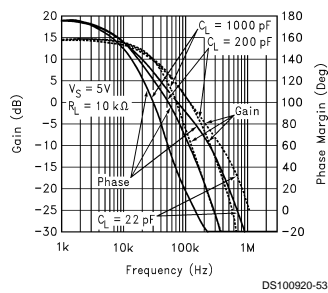

Slew Rate vs Supply Voltage

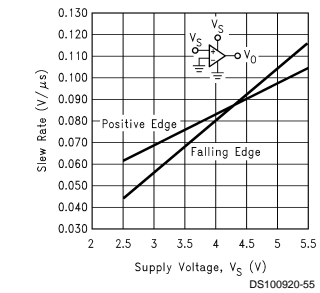

Non-Inverting Large Signal Pulse Response

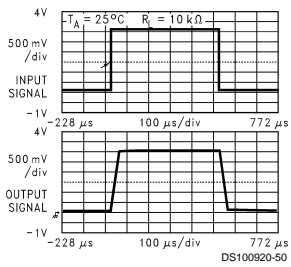

Non-Inverting Small Signal Pulse Response

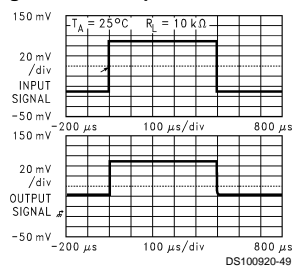

Inverting Large Signal Pulse Response

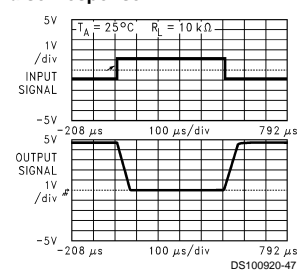

Typical Performance Characteristics Unless otherwise specified, $V_S = +5V$, single supply, $T_A = 25^\circ C$. (Continued)

Inverting Small Signal Pulse Response

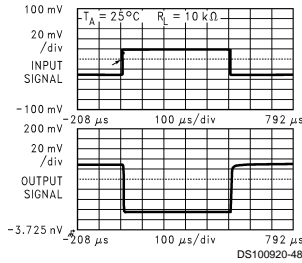

Stability vs Capacitive Load

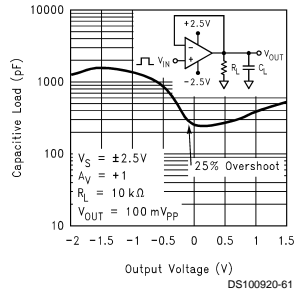

Stability vs Capacitive Load

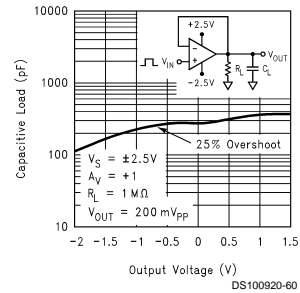

Stability vs Capacitive Load

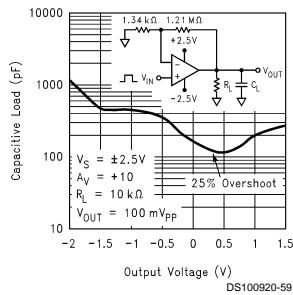

Stability vs Capacitive Load

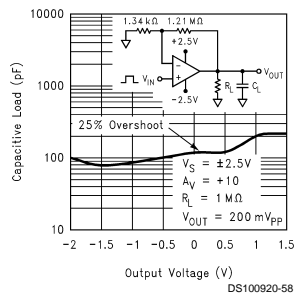

THD vs Frequency

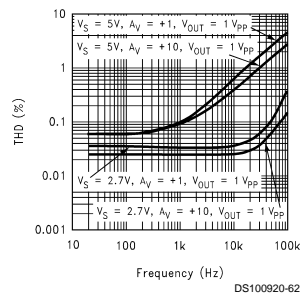

Open Loop Output Impedance vs Frequency

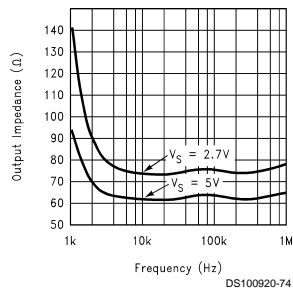

Short Circuit Current vs Temperature (Sinking)

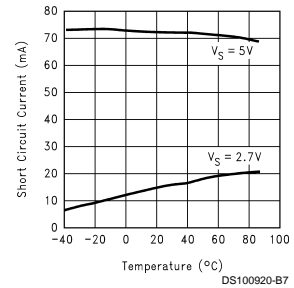

Short Circuit Current vs Temperature (Sourcing)

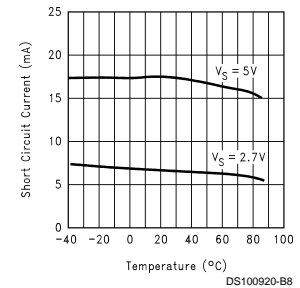

Application Notes

1.0 Benefits of the LPV321/358/324

Size. The small footprints of the LPV321/358/324 packages save space on printed circuit boards, and enable the design of smaller electronic products, such as cellular phones, pagers, or other portable systems. The low profile of the LPV321/358/324 make them possible to use in PCMCIA type III cards.

Signal Integrity. Signals can pick up noise between the signal source and the amplifier. By using a physically smaller

amplifier package, the LPV321/358/324 can be placed closer to the signal source, reducing noise pickup and increasing signal integrity.

Simplified Board Layout. These products help you to avoid using long pc traces in your pc board layout. This means that no additional components, such as capacitors and resistors, are needed to filter out the unwanted signals due to the interference between the long pc traces.

Low Supply Current. These devices will help you to maximize battery life. They are ideal for battery powered systems.

Application Notes (Continued)

Low Supply Voltage. National provides guaranteed performance at 2.7V and 5V. These guarantees ensure operation throughout the battery lifetime.

Rail-to-Rail Output. Rail-to-rail output swing provides maximum possible dynamic range at the output. This is particularly important when operating on low supply voltages.

Input Includes Ground. Allows direct sensing near GND in single supply operation.

The differential input voltage may be larger than V^+ without damaging the device. Protection should be provided to prevent the input voltages from going negative more than $-0.3V$ (at $25^\circ C$). An input clamp diode with a resistor to the IC input terminal can be used.

2.0 Capacitive Load Tolerance

The LPV321/358/324 can directly drive 200 pF in unity-gain without oscillation. The unity-gain follower is the most sensitive configuration to capacitive loading. Direct capacitive loading reduces the phase margin of amplifiers. The combination of the amplifier's output impedance and the capacitive load induces phase lag. This results in either an underdamped pulse response or oscillation. To drive a heavier capacitive load, circuit in *Figure 1* can be used.

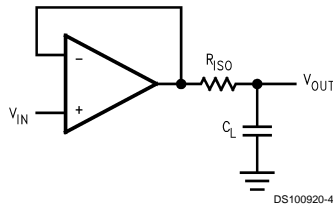

FIGURE 1. Indirectly Driving A Capacitive Load Using Resistive Isolation

In *Figure 1*, the isolation resistor R_{ISO} and the load capacitor C_L form a pole to increase stability by adding more phase margin to the overall system. The desired performance depends on the value of R_{ISO} . The bigger the R_{ISO} resistor value, the more stable V_{OUT} will be. *Figure 2* is an output waveform of *Figure 1* using $100k\Omega$ for R_{ISO} and $1000pF$ for C_L .

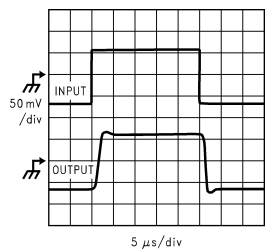

FIGURE 2. Pulse Response of the LPV324 Circuit in Figure 1

The circuit in *Figure 3* is an improvement to the one in *Figure 1* because it provides DC accuracy as well as AC stability. If there were a load resistor in *Figure 1*, the output would be voltage divided by R_{ISO} and the load resistor. Instead, in *Figure 3*, R_F provides the DC accuracy by using feed-forward techniques to connect V_{IN} to R_L . Caution is needed in choos-

ing the value of R_F due to the input bias current of the LPV321/358/324. C_F and R_{ISO} serve to counteract the loss of phase margin by feeding the high frequency component of the output signal back to the amplifier's inverting input, thereby preserving phase margin in the overall feedback loop. Increased capacitive drive is possible by increasing the value of C_F . This in turn will slow down the pulse response.

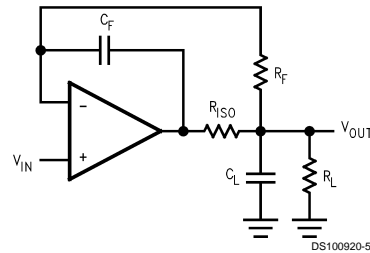

FIGURE 3. Indirectly Driving A Capacitive Load with DC Accuracy

3.0 Input Bias Current Cancellation

The LPV321/358/324 family has a bipolar input stage. The typical input bias current of LPV321/358/324 is $1.5nA$ with $5V$ supply. Thus a $100k\Omega$ input resistor will cause $0.15mV$ of error voltage. By balancing the resistor values at both inverting and non-inverting inputs, the error caused by the amplifier's input bias current will be reduced. The circuit in *Figure 4* shows how to cancel the error caused by input bias current.

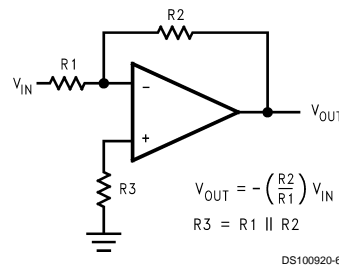

FIGURE 4. Cancelling the Error Caused by Input Bias Current

4.0 Typical Single-Supply Application Circuits

4.1 Difference Amplifier

The difference amplifier allows the subtraction of two voltages or, as a special case, the cancellation of a signal common to two inputs. It is useful as a computational amplifier, in making a differential to single-ended conversion or in rejecting a common mode signal.

Application Notes (Continued)

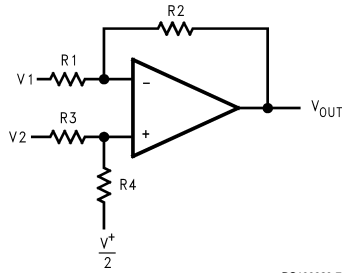

DS100920-7

$$V_{OUT} = \left(\frac{R1+R2}{R3+R4} \right) \frac{R4}{R1} V_2 - \frac{R2}{R1} V_1 + \left(\frac{R1+R2}{R3+R4} \right) \frac{R3}{R1} \cdot \frac{V^+}{2}$$

for $R1 = R3$ and $R2 = R4$

$$V_{OUT} = \frac{R2}{R1} (V_2 - V_1) + \frac{V^+}{2}$$

FIGURE 5. Difference Amplifier

4.2 Instrumentation Circuits

The input impedance of the previous difference amplifier is set by the resistor R_1 , R_2 , R_3 , and R_4 . To eliminate the problems of low input impedance, one way is to use a voltage follower ahead of each input as shown in the following two instrumentation amplifiers.

4.2.1 Three-op-amp Instrumentation Amplifier

The quad LPV324 can be used to build a three-op-amp instrumentation amplifier as shown in *Figure 6*

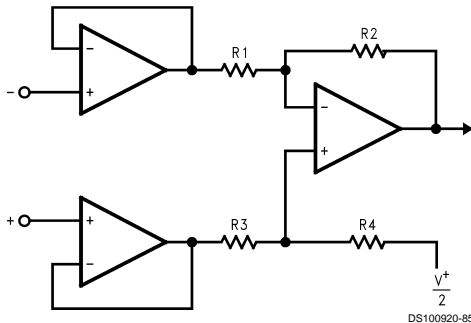

DS100920-85

FIGURE 6. Three-op-amp Instrumentation Amplifier

The first stage of this instrumentation amplifier is a differential-input, differential-output amplifier, with two voltage followers. These two voltage followers assure that the input impedance is over $100M\Omega$. The gain of this instrumentation amplifier is set by the ratio of R_2/R_1 . R_3 should equal R_1 and R_4 equal R_2 . Matching of R_3 to R_1 and R_4 to R_2 affects the CMRR. For good CMRR over temperature, low drift resistors should be used. Making R_4 slightly smaller than R_2 and adding a trim pot equal to twice the difference between R_2 and R_4 will allow the CMRR to be adjusted for optimum.

4.2.2 Two-op-amp Instrumentation Amplifier

A two-op-amp instrumentation amplifier can also be used to make a high-input-impedance DC differential amplifier (*Figure 7*). As in the three-op-amp circuit, this instrumentation amplifier requires precise resistor matching for good CMRR. R_4 should equal to R_1 and R_3 should equal R_2 .

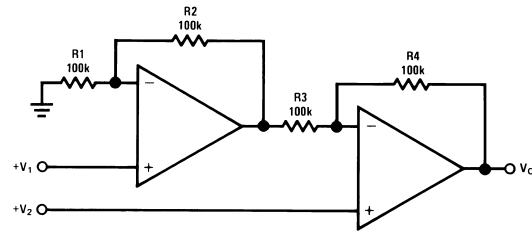

DS100920-11

$$V_0 = \left(1 + \frac{R4}{R3} \right) (V_2 - V_1), \text{ where } R1 = R4 \text{ and } R2 = R3$$

$$\text{As shown: } V_0 = 2(V_2 - V_1)$$

FIGURE 7. Two-op-amp Instrumentation Amplifier

4.3 Single-Supply Inverting Amplifier

There may be cases where the input signal going into the amplifier is negative. Because the amplifier is operating in single supply voltage, a voltage divider using R_3 and R_4 is implemented to bias the amplifier so the input signal is within the input common-mode voltage range of the amplifier. The capacitor C_1 is placed between the inverting input and resistor R_1 to block the DC signal going into the AC signal source, V_{IN} . The values of R_1 and C_1 affect the cutoff frequency, $f_c = 1/2\pi R_1 C_1$.

As a result, the output signal is centered around mid-supply (if the voltage divider provides $V^+/2$ at the non-inverting input). The output can swing to both rails, maximizing the signal-to-noise ratio in a low voltage system.

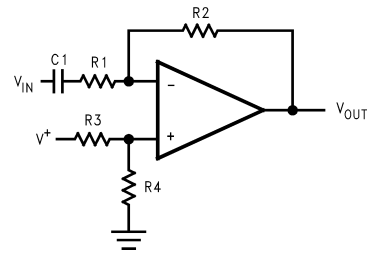

DS100920-13

$$V_{OUT} = -\frac{R2}{R1} V_{IN}$$

FIGURE 8. Single-Supply Inverting Amplifier

4.4 Active Filter

4.4.1 Simple Low-Pass Active Filter

The simple low-pass filter is shown in *Figure 9*. Its low-frequency gain ($\omega \rightarrow 0$) is defined by $-R_3/R_1$. This allows low-frequency gains other than unity to be obtained. The filter has a -20dB/decade roll-off after its corner frequency f_c . R_2 should be chosen equal to the parallel combination of R_1 and R_3 to minimize errors due to bias current. The frequency response of the filter is shown in *Figure 10*

Application Notes (Continued)

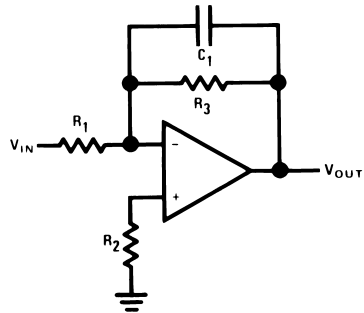

DS100920-14

$$A_L = -\frac{R_3}{R_1}$$

$$f_c = \frac{1}{2\pi R_3 C_1}$$

$$R_2 = R_1 \parallel R_3$$

FIGURE 9. Simple Low-Pass Active Filter

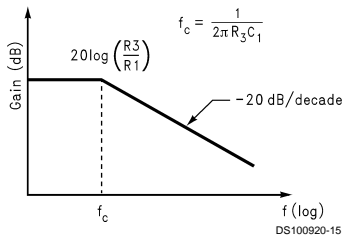

DS100920-15

FIGURE 10. Frequency Response of Simple Low-pass Active Filter in Figure 9

Note that the single-op-amp active filters are used in to the applications that require low quality factor, $Q (\leq 10)$, low frequency ($\leq 5\text{KHz}$), and low gain (≤ 10), or a small value for the product of gain times $Q (\leq 100)$. The op amp should have an open loop voltage gain at the highest frequency of interest at least 50 times larger than the gain of the filter at this frequency. In addition, the selected op amp should have a slew rate that meets the following requirement:

$$\text{SlewRate} \geq 0.5 \times (\omega_H V_{OPP}) \times 10^{-6} \text{V}/\mu\text{sec}$$

Where ω_H is the highest frequency of interest, and V_{OPP} is the output peak-to-peak voltage.

SC70-5 Tape and Reel Specification

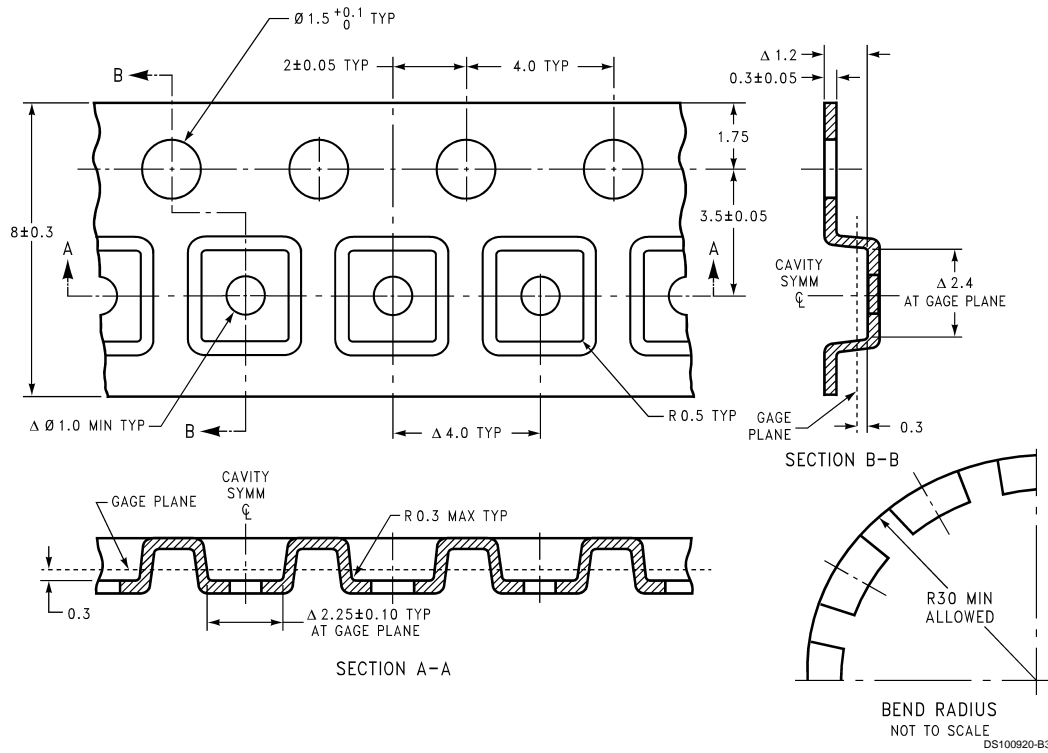

SOT-23-5 Tape and Reel Specification

TAPE FORMAT

Tape Section	# Cavities	Cavity Status	Cover Tape Status
Leader (Start End)	0 (min)	Empty	Sealed
	75 (min)	Empty	Sealed
Carrier	3000	Filled	Sealed
	250	Filled	Sealed
Trailer (Hub End)	125 (min)	Empty	Sealed
	0 (min)	Empty	Sealed

SOT-23-5 Tape and Reel Specification (Continued)

TAPE DIMENSIONS

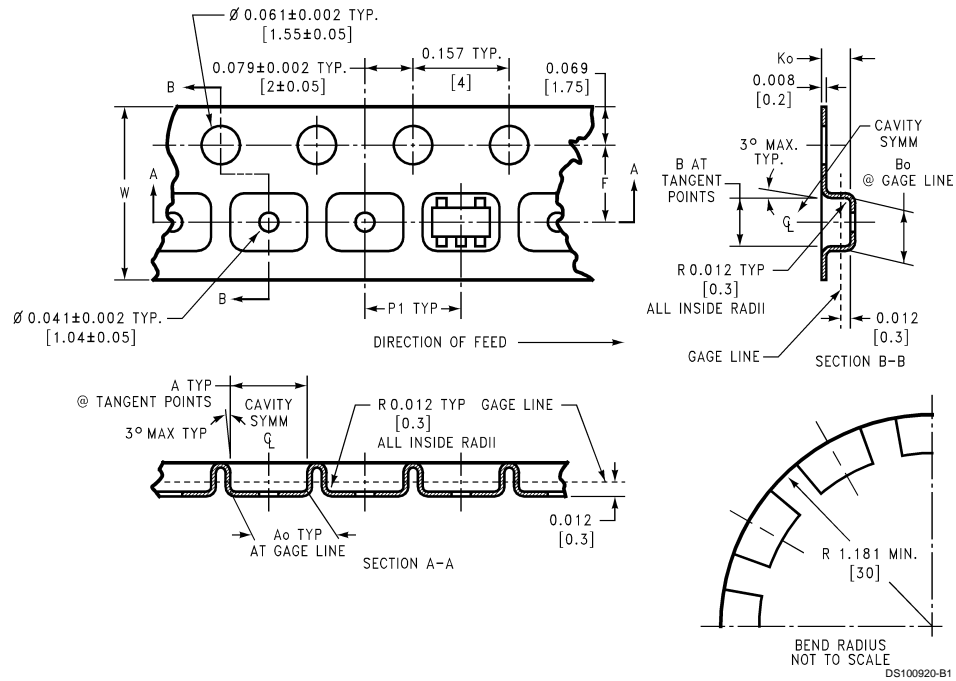

8 mm	0.130	0.124	0.130	0.126	0.138 ±0.002	0.055 ±0.004	0.157	0.315 ±0.012
	(3.3)	(3.15)	(3.3)	(3.2)	(3.5 ±0.05)	(1.4 ±0.11)	(4)	(8 ±0.3)
Tape Size	DIM A	DIM Ao	DIM B	DIM Bo	DIM F	DIM Ko	DIM P1	DIM W

SOT-23-5 Tape and Reel Specification (Continued)

REEL DIMENSIONS

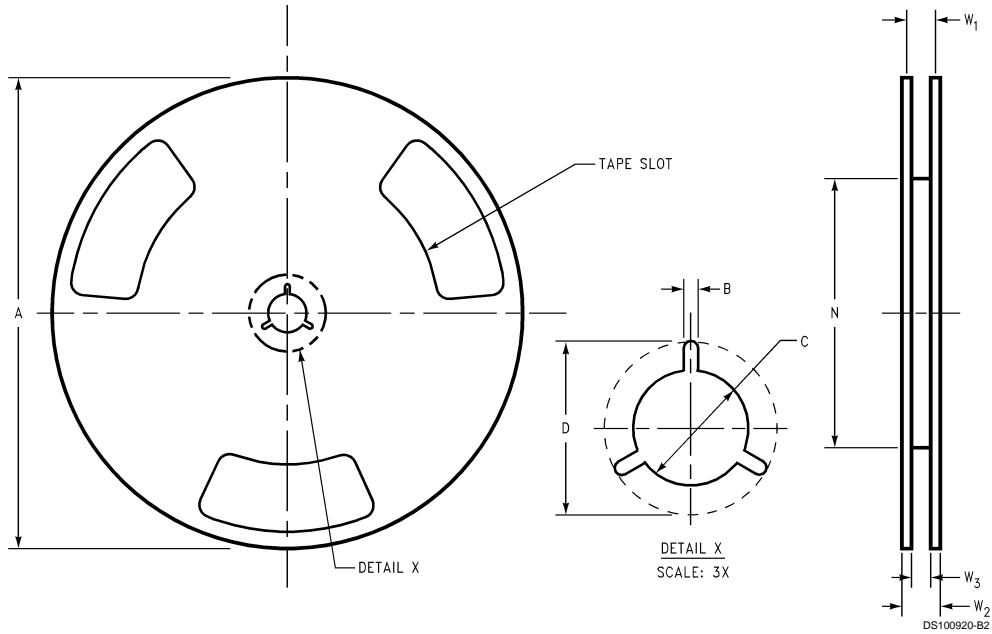

8 mm	7.00	0.059	0.512	0.795	2.165	$0.331 + 0.059/-0.000$	0.567	$W1 + 0.078/-0.039$
	330.00	1.50	13.00	20.20	55.00	$8.40 + 1.50/-0.00$	14.40	$W1 + 2.00/-1.00$
Tape Size	A	B	C	D	N	W1	W2	W3

Physical Dimensions inches (millimeters) unless otherwise noted

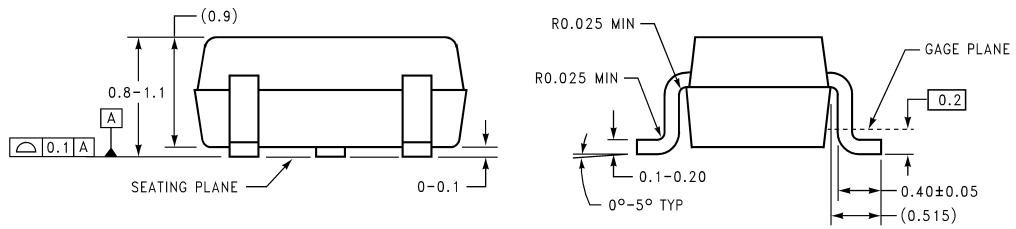
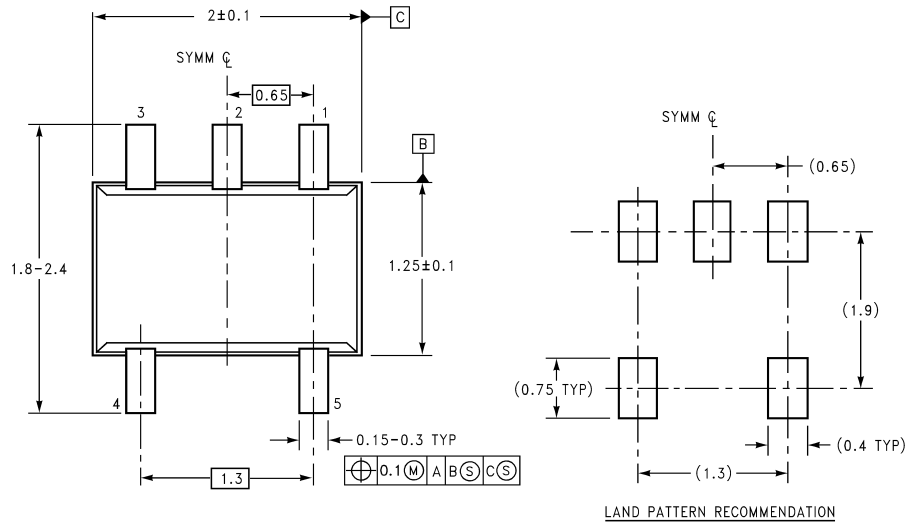

DIMENSIONS ARE IN MILLIMETERS

MAA05A (REV B)

5-Pin SC70-5 Tape and Reel
Order Number LPV321M7 and LPV321M7X
NS Package Number MAA05A

Physical Dimensions inches (millimeters) unless otherwise noted (Continued)

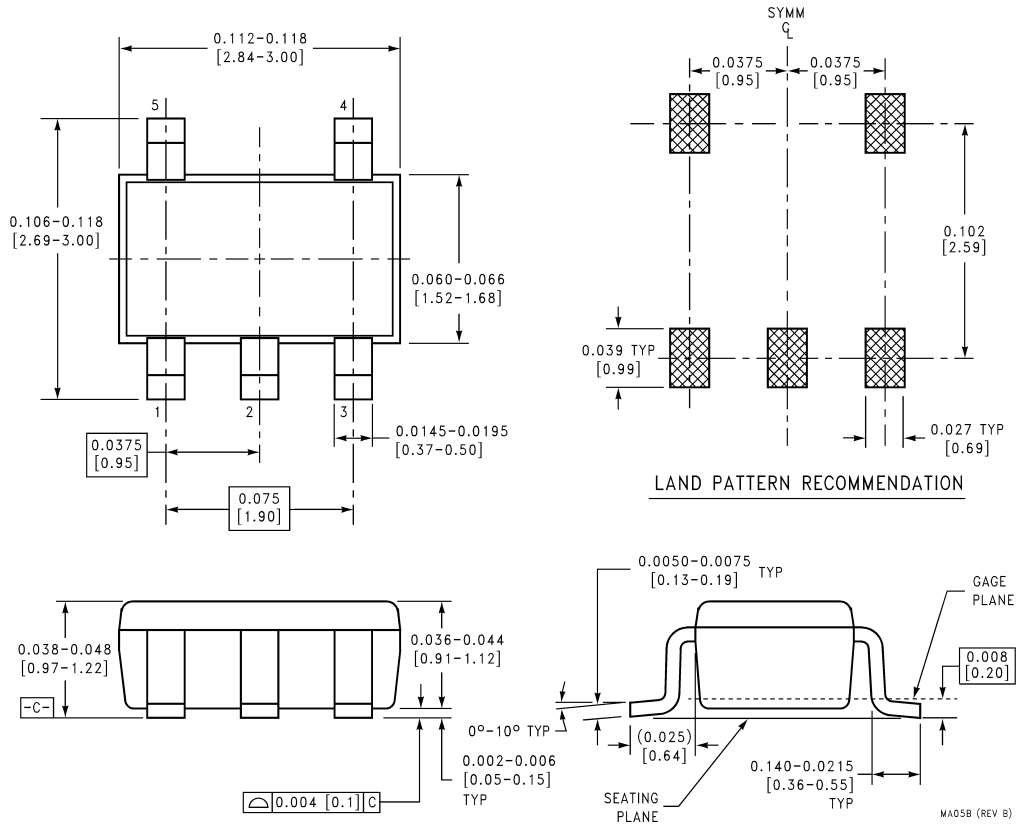

5-Pin SOT23-5 Tape and Reel
Order Number LPV321M5 and LPV321M5X
NS Package Number MA05B

MA05B (REV B)

Physical Dimensions inches (millimeters) unless otherwise noted (Continued)

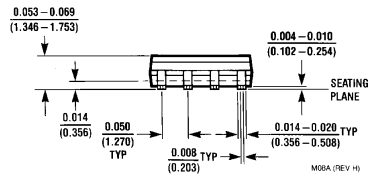
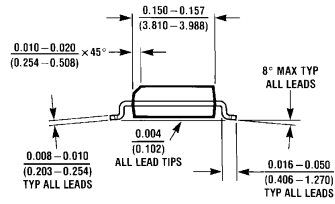
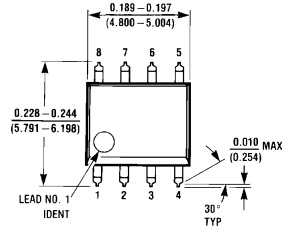

8-Pin Small Outline
Order Number LPV358M and LPV358MX
NS Package Number M08A

Physical Dimensions inches (millimeters) unless otherwise noted (Continued)

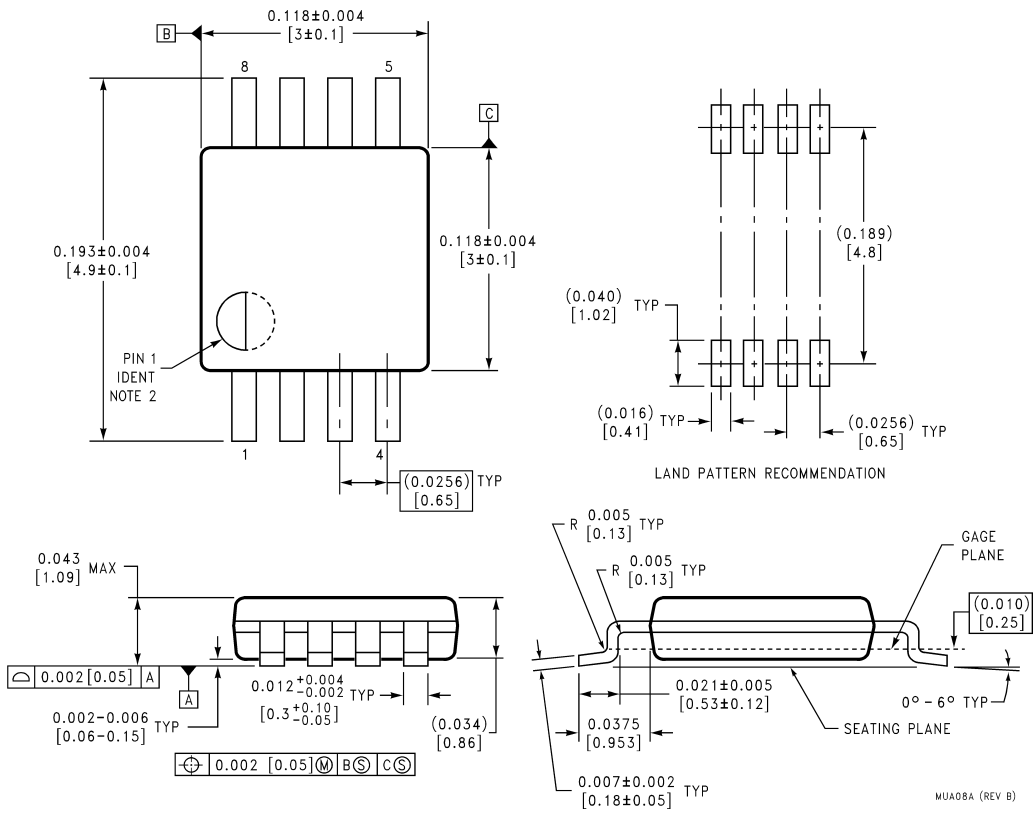

8-Pin MSOP
Order Number LPV358MM and LPV358MMX
NS Package Number MUA08A

MUA08A (REV B)

Physical Dimensions inches (millimeters) unless otherwise noted (Continued)

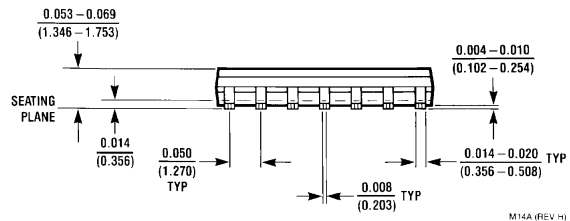
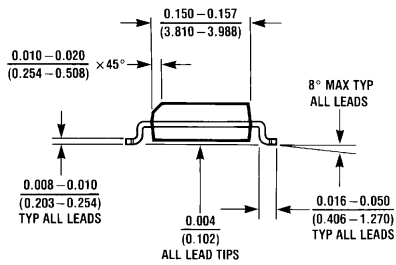
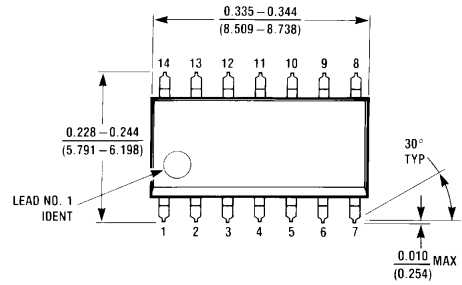

14-Pin Small Outline
Order Number LPV324M and LPV324MX
NS Package Number M14A

M14A (REV H)

Physical Dimensions inches (millimeters) unless otherwise noted (Continued)

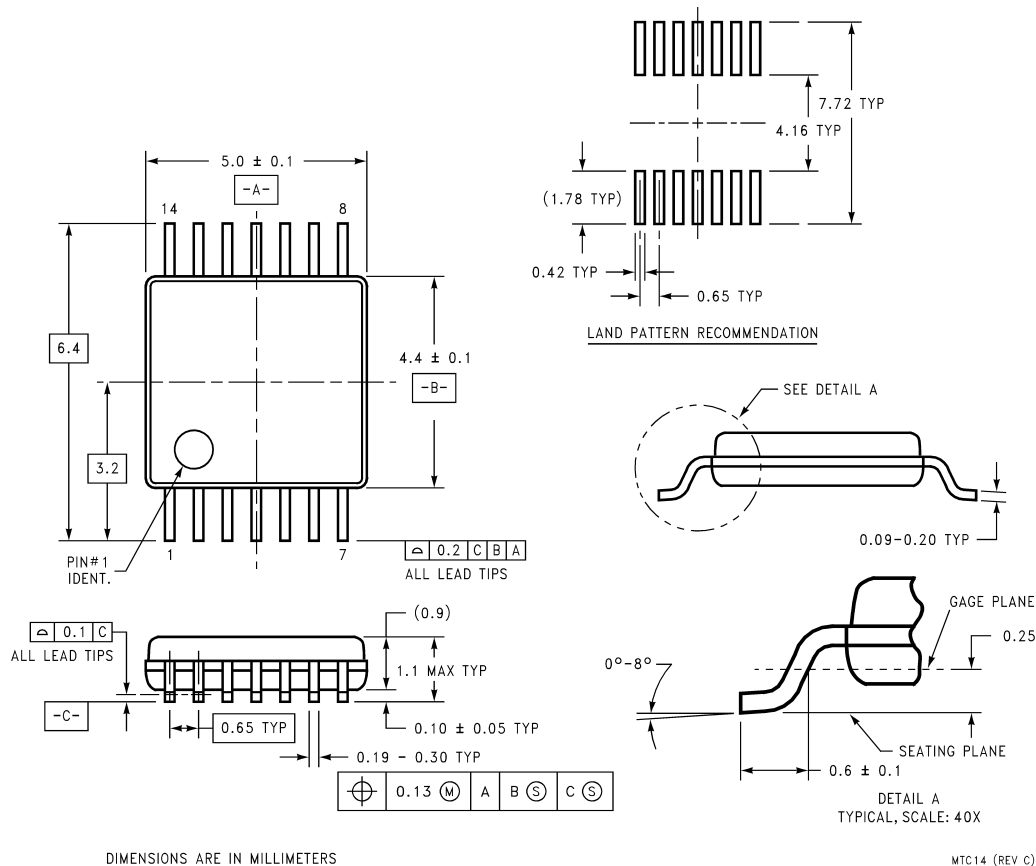

14-Pin TSSOP
Order Number LPV324MT and LPV324MTX
NS Package Number MTC14

LIFE SUPPORT POLICY

NATIONAL'S PRODUCTS ARE NOT AUTHORIZED FOR USE AS CRITICAL COMPONENTS IN LIFE SUPPORT DEVICES OR SYSTEMS WITHOUT THE EXPRESS WRITTEN APPROVAL OF THE PRESIDENT AND GENERAL COUNSEL OF NATIONAL SEMICONDUCTOR CORPORATION. As used herein:

1. Life support devices or systems are devices or systems which, (a) are intended for surgical implant into the body, or (b) support or sustain life, and whose failure to perform when properly used in accordance with instructions for use provided in the labeling, can be reasonably expected to result in a significant injury to the user.
2. A critical component is any component of a life support device or system whose failure to perform can be reasonably expected to cause the failure of the life support device or system, or to affect its safety or effectiveness.

National Semiconductor Corporation
 Americas
 Tel: 1-800-272-9959
 Fax: 1-800-737-7018
 Email: support@nsc.com
 www.national.com

National Semiconductor Europe
 Fax: +49 (0) 1 80-530 85 86
 Email: europe.support@nsc.com
 Deutsch Tel: +49 (0) 1 80-530 85 85
 English Tel: +49 (0) 1 80-532 78 32
 Français Tel: +49 (0) 1 80-532 93 58
 Italiano Tel: +49 (0) 1 80-534 16 80

National Semiconductor Asia Pacific Customer Response Group
 Tel: 65-2544466
 Fax: 65-2504466
 Email: sea.support@nsc.com

National Semiconductor Japan Ltd.
 Tel: 81-3-5639-7560
 Fax: 81-3-5639-7507

National does not assume any responsibility for use of any circuitry described, no circuit patent licenses are implied and National reserves the right at any time without notice to change said circuitry and specifications.