

MCR72-3, MCR72-6, MCR72-8

Preferred Device

Sensitive Gate Silicon Controlled Rectifiers

Reverse Blocking Thyristors

Designed for industrial and consumer applications such as temperature, light and speed control; process and remote controls; warning systems; capacitive discharge circuits and MPU interface.

- Center Gate Geometry for Uniform Current Density
- All Diffused and Glass-Passivated Junctions for Parameter Uniformity and Stability
- Small, Rugged Thermowatt Construction for Low Thermal Resistance, High Heat Dissipation and Durability
- Low Trigger Currents, 200 μ A Maximum for Direct Driving from Integrated Circuits
- Device Marking: Logo, Device Type, e.g., MCR72-3, Date Code

MAXIMUM RATINGS ($T_J = 25^\circ\text{C}$ unless otherwise noted)

Rating	Symbol	Value	Unit
Peak Repetitive Off-State Voltage ⁽¹⁾ ($T_J = -40$ to 110°C , Sine Wave, 50 to 60 Hz, Gate Open) MCR72-3 MCR72-6 MCR72-8	V_{DRM} , V_{RRM}	100 400 600	Volts
On-State RMS Current (180° Conduction Angles; $T_C = 83^\circ\text{C}$)	$I_T(\text{RMS})$	8.0	Amps
Peak Non-Repetitive Surge Current (1/2 Cycle, 60 Hz, $T_J = 110^\circ\text{C}$)	I_{TSM}	100	Amps
Circuit Fusing Considerations ($t = 8.3$ ms)	I^2t	40	A^2s
Forward Peak Gate Voltage ($t \leq 10$ μs , $T_C = 83^\circ\text{C}$)	V_{GM}	± 5.0	Volts
Forward Peak Gate Current ($t \leq 10$ μs , $T_C = 83^\circ\text{C}$)	I_{GM}	1.0	Amp
Forward Peak Gate Power ($t \leq 10$ μs , $T_C = 83^\circ\text{C}$)	P_{GM}	5.0	Watts
Average Gate Power ($t = 8.3$ ms, $T_C = 83^\circ\text{C}$)	$P_{G(AV)}$	0.75	Watt
Operating Junction Temperature Range	T_J	-40 to +110	$^\circ\text{C}$
Storage Temperature Range	T_{stg}	-40 to +150	$^\circ\text{C}$
Mounting Torque	—	8.0	in. lb.

(1) V_{DRM} and V_{RRM} for all types can be applied on a continuous basis. Ratings apply for zero or negative gate voltage; however, positive gate voltage shall not be applied concurrent with negative potential on the anode. Blocking voltages shall not be tested with a constant current source such that the voltage ratings of the devices are exceeded.



ON Semiconductor

<http://onsemi.com>

SCRs
8 AMPERES RMS
100 thru 600 VOLTS

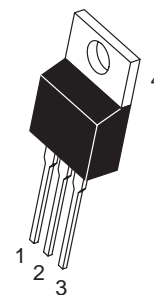

TO-220AB
CASE 221A
STYLE 3

PIN ASSIGNMENT	
1	Cathode
2	Anode
3	Gate
4	Anode

ORDERING INFORMATION

Device	Package	Shipping
MCR72-3	TO220AB	500/Box
MCR72-6	TO220AB	500/Box
MCR72-8	TO220AB	500/Box

Preferred devices are recommended choices for future use and best overall value.

MCR72-3, MCR72-6, MCR72-8

THERMAL CHARACTERISTICS

Characteristic	Symbol	Max	Unit
Thermal Resistance, Junction to Case	$R_{\theta JC}$	2.2	$^{\circ}C/W$
Thermal Resistance, Junction to Ambient	$R_{\theta JA}$	60	$^{\circ}C/W$
Maximum Lead Temperature for Soldering Purposes 1/8" from Case for 10 Seconds	T_L	260	$^{\circ}C$

ELECTRICAL CHARACTERISTICS ($T_C = 25^{\circ}C$ unless otherwise noted.)

Characteristic	Symbol	Min	Typ	Max	Unit
----------------	--------	-----	-----	-----	------

OFF CHARACTERISTICS

Peak Repetitive Forward or Reverse Blocking Current ⁽¹⁾ ($V_{AK} = \text{Rated } V_{DRM} \text{ or } V_{RRM}; R_{GK} = 1 \text{ k}\Omega$)	I_{DRM}, I_{RRM}	—	—	10	μA
$T_J = 25^{\circ}C$		—	—	500	μA
$T_J = 110^{\circ}C$		—	—		

ON CHARACTERISTICS

Peak Forward On-State Voltage ($I_{TM} = 16 \text{ A Peak, Pulse Width } \leq 1 \text{ ms, Duty Cycle } \leq 2\%$)	V_{TM}	—	1.7	2.0	Volts
Gate Trigger Current (Continuous dc) ⁽²⁾ ($V_D = 12 \text{ V, } R_L = 100 \Omega$)	I_{GT}	—	30	200	μA
Gate Trigger Voltage (Continuous dc) ⁽²⁾ ($V_D = 12 \text{ V, } R_L = 100 \Omega$)	V_{GT}	—	0.5	1.5	Volts
Gate Non-Trigger Voltage ($V_D = 12 \text{ Vdc, } R_L = 100 \Omega, T_J = 110^{\circ}C$)	V_{GD}	0.1	—	—	Volts
Holding Current ($V_D = 12 \text{ V, Initiating Current} = 200 \text{ mA, Gate Open}$)	I_H	—	—	6.0	mA
Gate Controlled Turn-On Time ($V_D = \text{Rated } V_{DRM}, I_{TM} = 16 \text{ A, } I_G = 2 \text{ mA}$)	t_{gt}	—	1.0	—	μs

DYNAMIC CHARACTERISTICS

Critical Rate-of-Rise of Off-State Voltage ($V_D = \text{Rated } V_{DRM}, R_{GK} = 1 \text{ k}\Omega, T_J = 110^{\circ}C, \text{ Exponential Waveform}$)	dv/dt	—	10	—	$V/\mu s$
---	---------	---	----	---	-----------

(1) Ratings apply for negative gate voltage or $R_{GK} = 1 \text{ k}\Omega$. Devices shall not have a positive gate voltage concurrently with a negative voltage on the anode. Devices should not be tested with a constant current source for forward and reverse blocking capability such that the voltage applied exceeds the rated blocking voltage.

(2) R_{GK} current not included in measurement.

MCR72-3, MCR72-6, MCR72-8

Voltage Current Characteristic of SCR

Symbol	Parameter
V_{DRM}	Peak Repetitive Off State Forward Voltage
I_{DRM}	Peak Forward Blocking Current
V_{RRM}	Peak Repetitive Off State Reverse Voltage
I_{RRM}	Peak Reverse Blocking Current
V_{TM}	Peak On State Voltage
I_H	Holding Current

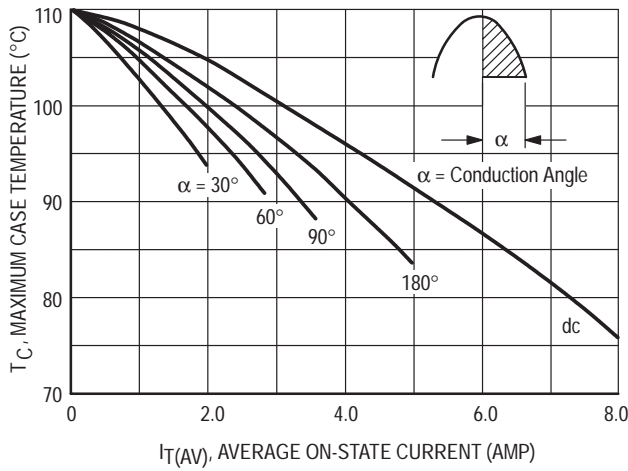
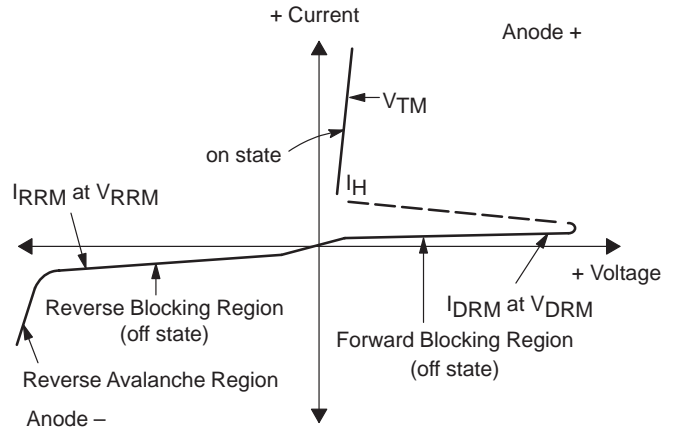

Figure 1. Average Current Derating

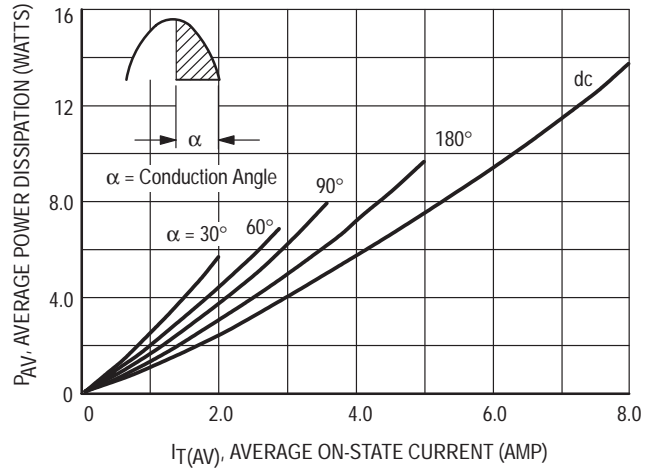

Figure 2. On-State Power Dissipation

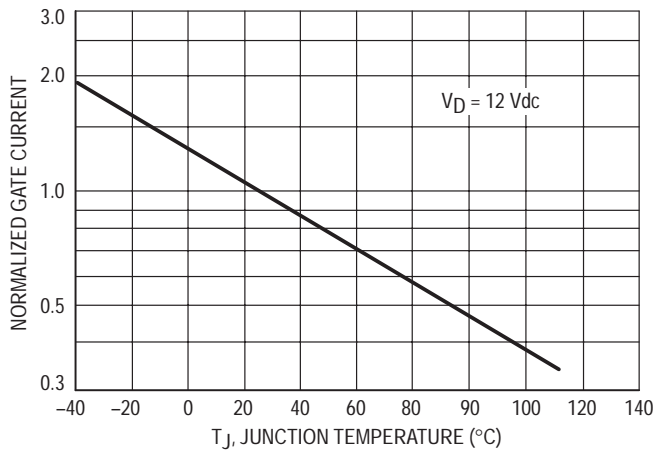

Figure 3. Normalized Gate Current

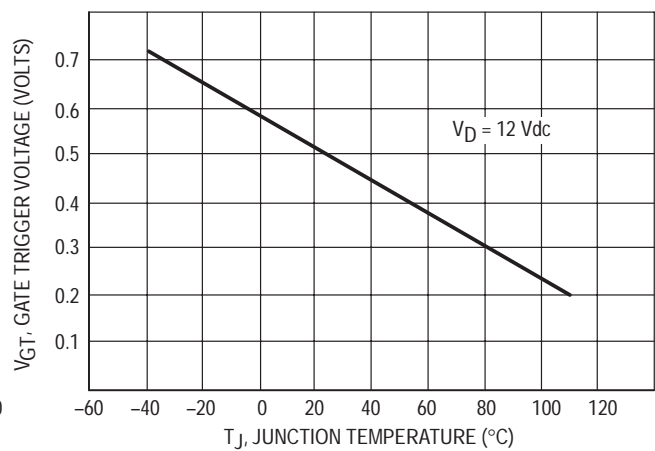
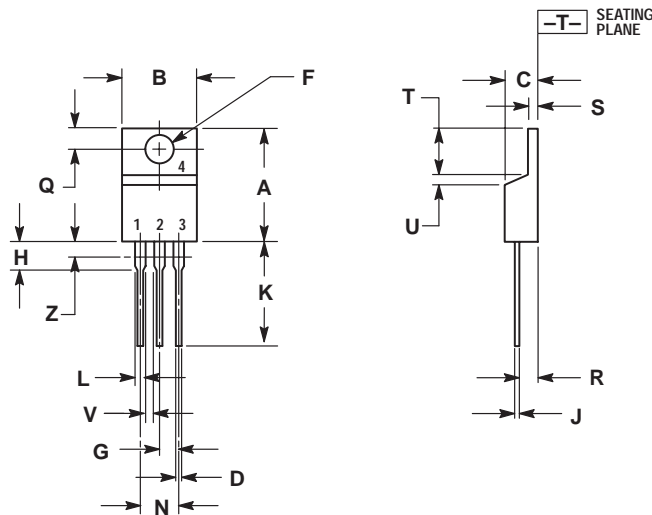

Figure 4. Gate Voltage

MCR72-3, MCR72-6, MCR72-8

PACKAGE DIMENSIONS

TO-220AB CASE 221A-07 ISSUE Z



NOTES:

1. DIMENSIONING AND TOLERANCING PER ANSI Y14.5M, 1982.
2. CONTROLLING DIMENSION: INCH.
3. DIMENSION Z DEFINES A ZONE WHERE ALL BODY AND LEAD IRREGULARITIES ARE ALLOWED.

DIM	INCHES		MILLIMETERS	
	MIN	MAX	MIN	MAX
A	0.570	0.620	14.48	15.75
B	0.380	0.405	9.66	10.28
C	0.160	0.190	4.07	4.82
D	0.025	0.035	0.64	0.88
F	0.142	0.147	3.61	3.73
G	0.095	0.105	2.42	2.66
H	0.110	0.155	2.80	3.93
J	0.014	0.022	0.36	0.55
K	0.500	0.562	12.70	14.27
L	0.045	0.060	1.15	1.52
N	0.190	0.210	4.83	5.33
Q	0.100	0.120	2.54	3.04
R	0.080	0.110	2.04	2.79
S	0.045	0.055	1.15	1.39
T	0.235	0.255	5.97	6.47
U	0.000	0.050	0.00	1.27
V	0.045	---	1.15	---
Z	---	0.080	---	2.04

STYLE 3:

1. CATHODE
2. ANODE
3. GATE
4. ANODE

ON Semiconductor and  are trademarks of Semiconductor Components Industries, LLC (SCILLC). SCILLC reserves the right to make changes without further notice to any products herein. SCILLC makes no warranty, representation or guarantee regarding the suitability of its products for any particular purpose, nor does SCILLC assume any liability arising out of the application or use of any product or circuit, and specifically disclaims any and all liability, including without limitation special, consequential or incidental damages. "Typical" parameters which may be provided in SCILLC data sheets and/or specifications can and do vary in different applications and actual performance may vary over time. All operating parameters, including "Typicals" must be validated for each customer application by customer's technical experts. SCILLC does not convey any license under its patent rights nor the rights of others. SCILLC products are not designed, intended, or authorized for use as components in systems intended for surgical implant into the body, or other applications intended to support or sustain life, or for any other application in which the failure of the SCILLC product could create a situation where personal injury or death may occur. Should Buyer purchase or use SCILLC products for any such unintended or unauthorized application, Buyer shall indemnify and hold SCILLC and its officers, employees, subsidiaries, affiliates, and distributors harmless against all claims, costs, damages, and expenses, and reasonable attorney fees arising out of, directly or indirectly, any claim of personal injury or death associated with such unintended or unauthorized use, even if such claim alleges that SCILLC was negligent regarding the design or manufacture of the part. SCILLC is an Equal Opportunity/Affirmative Action Employer.

PUBLICATION ORDERING INFORMATION

NORTH AMERICA Literature Fulfillment:

Literature Distribution Center for ON Semiconductor
P.O. Box 5163, Denver, Colorado 80217 USA
Phone: 303-675-2175 or 800-344-3860 Toll Free USA/Canada
Fax: 303-675-2176 or 800-344-3867 Toll Free USA/Canada
Email: ONlit@hibbertco.com
Fax Response Line: 303-675-2167 or 800-344-3810 Toll Free USA/Canada

N. American Technical Support: 800-282-9855 Toll Free USA/Canada

EUROPE: LDC for ON Semiconductor – European Support

German Phone: (+1) 303-308-7140 (M-F 1:00pm to 5:00pm Munich Time)
Email: ONlit-german@hibbertco.com
French Phone: (+1) 303-308-7141 (M-F 1:00pm to 5:00pm Toulouse Time)
Email: ONlit-french@hibbertco.com
English Phone: (+1) 303-308-7142 (M-F 12:00pm to 5:00pm UK Time)
Email: ONlit@hibbertco.com

EUROPEAN TOLL-FREE ACCESS*: 00-800-4422-3781

*Available from Germany, France, Italy, England, Ireland

CENTRAL/SOUTH AMERICA:

Spanish Phone: 303-308-7143 (Mon-Fri 8:00am to 5:00pm MST)
Email: ONlit-spanish@hibbertco.com

ASIA/PACIFIC: LDC for ON Semiconductor – Asia Support

Phone: 303-675-2121 (Tue-Fri 9:00am to 1:00pm, Hong Kong Time)
Toll Free from Hong Kong & Singapore:
001-800-4422-3781
Email: ONlit-asia@hibbertco.com

JAPAN: ON Semiconductor, Japan Customer Focus Center

4-32-1 Nishi-Gotanda, Shinagawa-ku, Tokyo, Japan 141-8549
Phone: 81-3-5740-2745
Email: r14525@onsemi.com

ON Semiconductor Website: <http://onsemi.com>

For additional information, please contact your local Sales Representative.

MCR72/D