



SANYO Semiconductors

# DATA SHEET

An ON Semiconductor Company

NPN Epitaxial Planar Silicon Transistor

## MCH4009 — UHF to X Band Low-Noise Amplifier and OSC Applications

### Features

- Low-noise use : NF=1.1dB typ (f=2GHz).
- High cut-off frequency :  $f_T=25\text{GHz}$  typ ( $V_{CE}=3\text{V}$ ).
- Low operating voltage.
- High gain :  $|S_{21e}|^2=17\text{dB}$  typ (f=2GHz).

### Specifications

Absolute Maximum Ratings at  $T_a=25^\circ\text{C}$ 

Parameter	Symbol	Conditions	Ratings	Unit
Collector-to-Base Voltage	$V_{CBO}$		10	V
Collector-to-Emitter Voltage	$V_{CEO}$		3.5	V
Emitter-to-Base Voltage	$V_{EBO}$		2.5	V
Collector Current	$I_C$		40	mA
Collector Dissipation	$P_C$		120	mW
Junction Temperature	$T_j$		150	$^\circ\text{C}$
Storage Temperature	$T_{stg}$		-55 to +150	$^\circ\text{C}$

Electrical Characteristics at  $T_a=25^\circ\text{C}$ 

Parameter	Symbol	Conditions	Ratings			Unit
			min	typ	max	
Collector Cutoff Current	$I_{CBO}$	$V_{CB}=5\text{V}, I_E=0\text{A}$			1.0	$\mu\text{A}$
Emitter Cutoff Current	$I_{EBO}$	$V_{EB}=1\text{V}, I_C=0\text{A}$			1.0	$\mu\text{A}$
DC Current Gain	$h_{FE}$	$V_{CE}=1\text{V}, I_C=5\text{mA}$	50		120	
Gain-Bandwidth Product	$f_T$	$V_{CE}=3\text{V}, I_C=20\text{mA}$	20	25		GHz
Reverse Transfer Capacitance	$C_{re}$	$V_{CB}=1\text{V}, f=1\text{MHz}$		0.15		pF
Forward Transfer Gain	$ S_{21e} ^{21}$	$V_{CE}=1\text{V}, I_C=5\text{mA}, f=2\text{GHz}$	9	13.5		dB
	$ S_{21e} ^{22}$	$V_{CE}=3\text{V}, I_C=20\text{mA}, f=2\text{GHz}$		17		dB
Noise Figure	NF	$V_{CE}=1\text{V}, I_C=5\text{mA}, f=2\text{GHz}$		1.1	1.5	dB
1dB Compression Point	$PO(1\text{dB})$	$V_{CE}=3\text{V}, I_C=20\text{mA}, f=2\text{GHz}$		13.5		dBm
3rd Order Intercept Point	$OIP_3$	$V_{CE}=3\text{V}, I_C=20\text{mA}, f=2\text{GHz}$		23		dBm

Marking : GG

■ Any and all SANYO Semiconductor products described or contained herein do not have specifications that can handle applications that require extremely high levels of reliability, such as life-support systems, aircraft's control systems, or other applications whose failure can be reasonably expected to result in serious physical and/or material damage. Consult with your SANYO Semiconductor representative nearest you before using any SANYO Semiconductor products described or contained herein in such applications.

■ SANYO Semiconductor assumes no responsibility for equipment failures that result from using products at values that exceed, even momentarily, rated values (such as maximum ratings, operating condition ranges, or other parameters) listed in products specifications of any and all SANYO Semiconductor products described or contained herein.

**SANYO Semiconductor Co., Ltd.**

TOKYO OFFICE Tokyo Bldg., 1-10, 1 Chome, Ueno, Taito-ku, TOKYO, 110-8534 JAPAN

# MCH4009

## Package Dimensions

unit : mm  
7020A-002

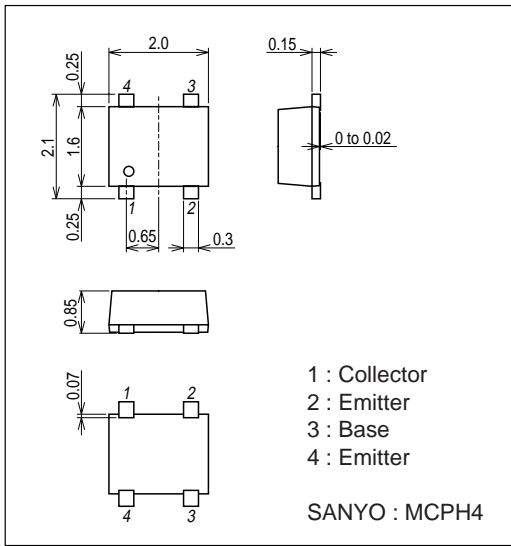

## Type No. Indication

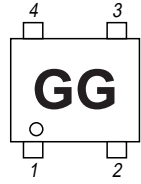

1 : Collector  
2 : Emitter  
3 : Base  
4 : Emitter

Top view

Pay attention to handling since it is liable to be affected by static electricity due to the high-frequency process adopted.

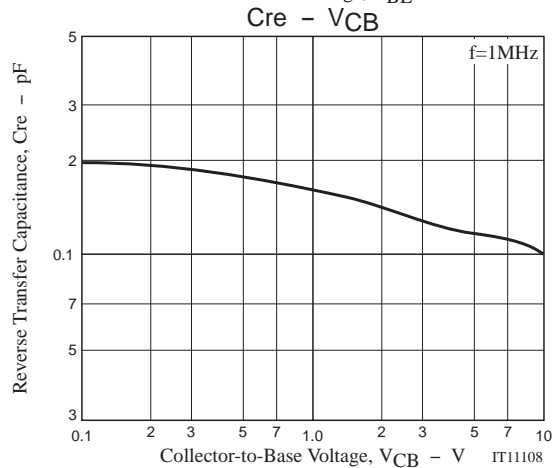
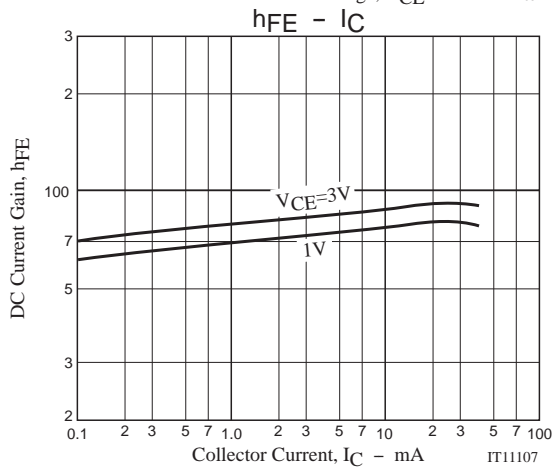
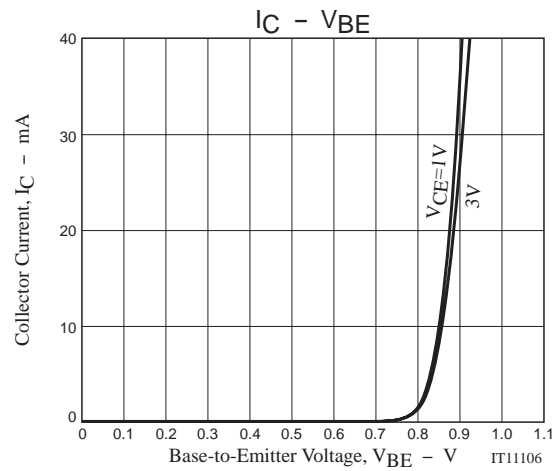
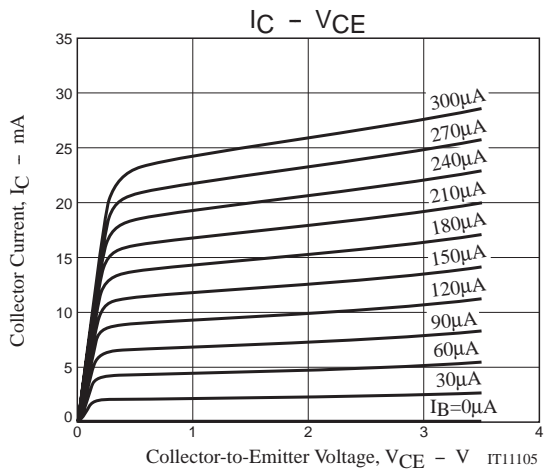

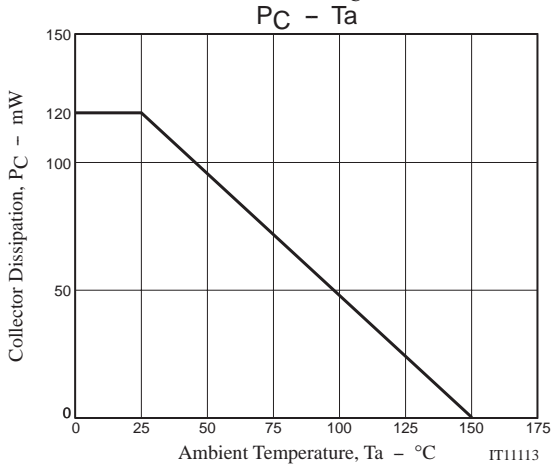
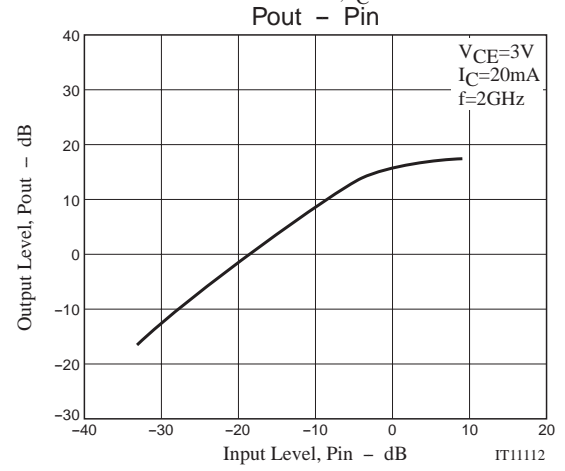
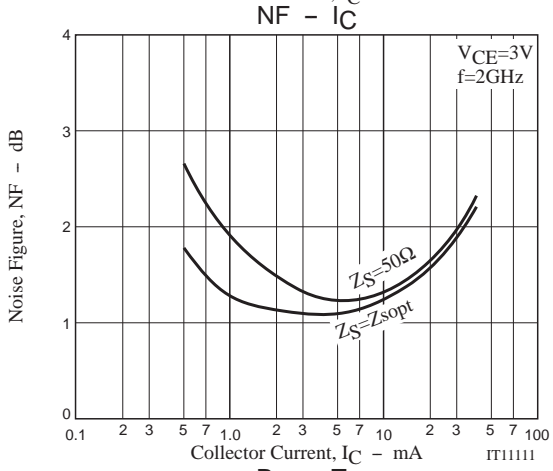
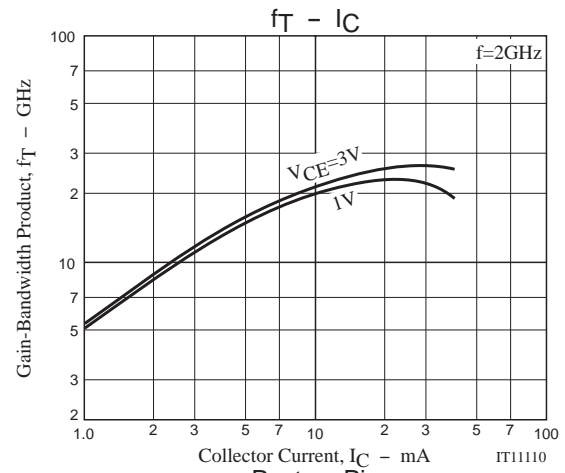
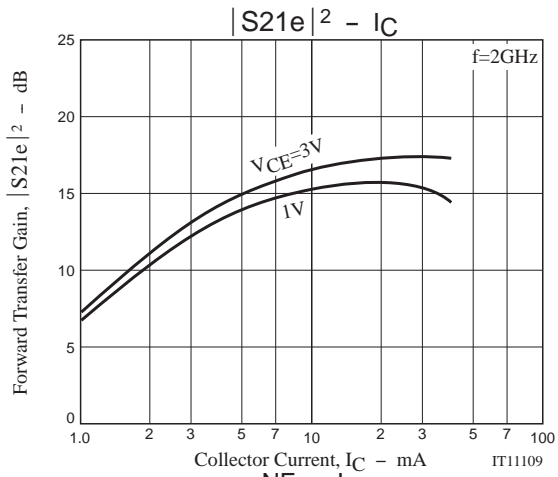

# MCH4009

## SPICE Parameters

model : Gummel-Poon

Parameter	Value	Unit	Parameter	Value	Unit																																										
IS	38.78a	A	XTF	11.00f																																											
BF	107.6		VTF	81.1	V																																										
NF	1.002		ITF	1.55	A																																										
VAF	34.79	V	PTF	32	°C																																										
IKF	199.6m	A	CJC	214.0f	F																																										
ISE	138.1f	A	VJC	111.7m	V																																										
NE	2.5		MJC	118.0m																																											
BR	1.5		XCJC	833.8m																																											
NR	1.05		TR	50.00p	S																																										
VAR	200	V	FC	8.105m																																											
IKR	20.00m	A	CJS	123.2f	F																																										
ISC	0	A	VJS	140.0f	V																																										
NC	2		MJS	150																																											
RB	8.5	Ω	Lwb	415p	H																																										
IRB	143.2μ	A	Llb	210p	H																																										
RBM	1.584	Ω	Lwe	243.6p	H																																										
RE	1.022	Ω	Lle	12.8p	H																																										
RC	3.675	Ω	Lwc	330p	H	XTB	0		Llc	651.5p	H	EG	1.11	eV	Ccb	26.7f	F	XTI	3		Cec1	185.4f	F	CJE	250.0f	F	Cec2	40f	F	VJE	23.00m	V	Cbe1	65f	F	MJE	21.60m		Cbe2	25.2f	F	TF	5.398p	S			
XTB	0		Llc	651.5p	H																																										
EG	1.11	eV	Ccb	26.7f	F																																										
XTI	3		Cec1	185.4f	F																																										
CJE	250.0f	F	Cec2	40f	F																																										
VJE	23.00m	V	Cbe1	65f	F																																										
MJE	21.60m		Cbe2	25.2f	F																																										
TF	5.398p	S																																													

## Schematic

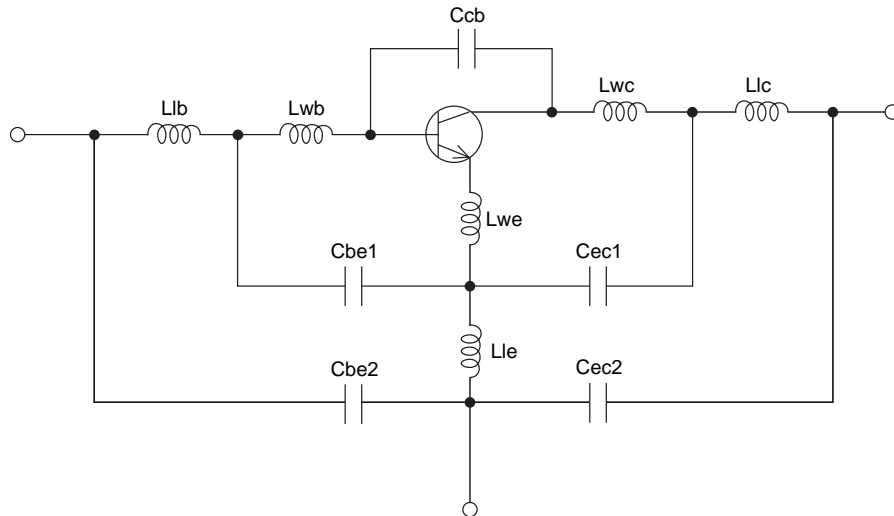

IT11114

\*Information (including circuit diagrams and circuit parameters) herein is for example only ; it is not guaranteed for volume production.

## MCH4009

### S Parameters (Common emitter)

$V_{CE}=1V, I_C=5mA$

Freq(MHz)	$ S_{11} $	$\angle S_{11}$	$ S_{21} $	$\angle S_{21}$	$ S_{12} $	$\angle S_{12}$	$ S_{22} $	$\angle S_{22}$
500	0.801	-49.4	10.891	140.0	0.046	63.0	0.783	-36.9
1000	0.662	-87.0	8.137	115.4	0.071	46.0	0.571	-58.5
1500	0.567	-113.5	6.269	98.7	0.083	37.4	0.431	-72.5
2000	0.521	-131.1	4.982	86.7	0.091	32.9	0.346	-82.4
2500	0.479	-147.7	4.152	77.3	0.097	30.1	0.294	-91.0
3000	0.461	-160.2	3.534	68.0	0.102	28.1	0.253	-95.9
3500	0.454	-170.5	3.096	60.2	0.107	27.1	0.223	-100.3
4000	0.450	-179.1	2.762	52.9	0.113	25.3	0.201	-103.1
4500	0.445	173.1	2.524	45.8	0.120	24.0	0.178	-106.4
5000	0.437	165.9	2.327	38.7	0.127	21.9	0.161	-109.5
5500	0.426	158.4	2.132	32.0	0.135	18.9	0.161	-112.6
6000	0.409	147.6	2.059	24.2	0.143	16.1	0.130	-124.6
6500	0.401	135.5	1.948	16.5	0.152	12.1	0.121	-137.7
7000	0.408	121.5	1.840	8.4	0.157	7.8	0.117	-154.8
7500	0.435	108.4	1.725	0.5	0.161	3.3	0.117	-171.6
8000	0.466	97.5	1.613	-7.2	0.164	-0.9	0.112	168.6
8500	0.509	90.3	1.513	-14.4	0.168	-5.5	0.114	148.9
9000	0.541	84.6	1.412	-21.3	0.169	-9.8	0.117	127.8
9500	0.568	80.7	1.338	-27.7	0.172	-13.7	0.132	107.8
10000	0.588	75.4	1.276	-34.8	0.175	-18.9	0.164	91.3
10500	0.599	70.5	1.213	-42.0	0.173	-24.2	0.201	82.3
11000	0.610	60.8	1.150	-49.4	0.176	-29.9	0.240	77.0
11500	0.622	51.5	1.093	-57.0	0.177	-36.1	0.275	74.3
12000	0.653	41.6	1.029	-65.3	0.172	-42.7	0.311	70.8
12500	0.687	33.1	0.959	-72.8	0.167	-48.5	0.331	67.0
13000	0.711	27.0	0.886	-80.1	0.161	-53.6	0.347	60.4
13500	0.741	23.6	0.824	-86.4	0.158	-58.4	0.351	52.6
14000	0.757	22.1	0.774	-92.9	0.154	-63.4	0.364	42.7
14500	0.757	20.6	0.725	-98.7	0.157	-67.6	0.382	33.0
15000	0.758	19.4	0.684	-104.8	0.159	-73.0	0.404	27.4

# MCH4009

## S Parameters (Common emitter)

$V_{CE}=1V, I_C=10mA$

Freq(MHz)	$ S_{11} $	$\angle S_{11}$	$ S_{21} $	$\angle S_{21}$	$ S_{12} $	$\angle S_{12}$	$ S_{22} $	$\angle S_{22}$
500	0.665	-68.4	16.105	129.6	0.040	58.4	0.676	-48.9
1000	0.536	-109.6	10.494	105.3	0.056	46.4	0.437	-72.8
1500	0.475	-134.8	7.518	90.9	0.067	42.6	0.310	-87.7
2000	0.448	-150.5	5.820	80.6	0.076	41.3	0.240	-98.9
2500	0.428	-164.9	4.763	72.3	0.085	40.3	0.200	-108.1
3000	0.421	-175.6	4.030	64.4	0.094	39.2	0.167	-114.4
3500	0.419	175.8	3.511	57.3	0.104	37.4	0.141	-119.4
4000	0.418	168.6	3.130	50.5	0.113	35.3	0.120	-122.6
4500	0.416	162.1	2.843	43.9	0.122	32.9	0.098	-126.9
5000	0.409	155.7	2.616	37.1	0.132	30.1	0.082	-130.0
5500	0.398	148.7	2.430	30.6	0.143	26.7	0.074	-132.1
6000	0.387	138.2	2.296	23.2	0.153	22.4	0.061	-154.0
6500	0.385	126.4	2.162	15.8	0.162	17.6	0.066	-174.5
7000	0.399	113.2	2.034	8.0	0.169	12.6	0.078	163.9
7500	0.429	101.2	1.904	0.5	0.174	7.4	0.094	147.2
8000	0.463	91.5	1.774	-6.8	0.178	2.7	0.110	128.3
8500	0.506	85.3	1.661	-13.7	0.181	-2.2	0.128	112.1
9000	0.538	80.6	1.555	-20.5	0.183	-7.1	0.148	95.7
9500	0.566	77.1	1.473	-26.6	0.187	-11.8	0.174	82.1
10000	0.586	72.4	1.395	-33.5	0.188	-17.1	0.211	72.4
10500	0.596	67.5	1.327	-40.3	0.187	-22.4	0.249	66.3
11000	0.611	58.0	1.261	-47.4	0.188	-28.5	0.282	63.3
11500	0.623	48.9	1.199	-54.8	0.188	-34.8	0.312	61.6
12000	0.654	39.3	1.131	-62.7	0.183	-41.8	0.345	59.4
12500	0.691	31.0	1.056	-70.1	0.177	-47.7	0.361	55.5
13000	0.715	25.2	0.978	-77.2	0.172	-52.7	0.375	49.4
13500	0.744	22.0	0.912	-83.5	0.169	-57.4	0.380	41.4
14000	0.756	20.6	0.859	-89.6	0.167	-62.0	0.394	32.0
14500	0.759	19.4	0.808	-95.4	0.168	-67.2	0.410	23.1
15000	0.756	18.1	0.774	-101.1	0.171	-72.6	0.428	16.9

## MCH4009

### S Parameters (Common emitter)

$V_{CE}=1V, I_C=20mA$

Freq(MHz)	$ S_{11} $	$\angle S_{11}$	$ S_{21} $	$\angle S_{21}$	$ S_{12} $	$\angle S_{12}$	$ S_{22} $	$\angle S_{22}$
500	0.537	-90.6	19.515	119.9	0.033	56.6	0.560	-60.3
1000	0.463	-131.2	11.501	98.0	0.047	50.3	0.333	-86.0
1500	0.437	-152.5	7.973	85.6	0.058	49.6	0.233	-102.7
2000	0.425	-165.4	6.106	76.7	0.070	49.8	0.179	-116.2
2500	0.417	-177.7	4.959	69.1	0.081	48.1	0.149	-127.4
3000	0.416	173.4	4.188	61.8	0.093	46.1	0.126	-136.7
3500	0.417	166.1	3.640	55.1	0.104	43.9	0.104	-144.6
4000	0.417	159.8	3.241	48.6	0.115	41.2	0.086	-151.3
4500	0.416	154.1	2.933	42.2	0.127	38.2	0.068	-162.2
5000	0.408	148.1	2.702	35.7	0.138	34.3	0.053	-173.4
5500	0.398	141.4	2.526	29.3	0.148	30.1	0.044	176.8
6000	0.391	131.4	2.359	22.1	0.160	25.4	0.051	150.8
6500	0.392	119.9	2.216	14.7	0.169	20.1	0.068	139.9
7000	0.410	107.5	2.078	7.1	0.177	15.0	0.091	130.4
7500	0.442	96.4	1.944	-0.2	0.181	9.3	0.112	120.9
8000	0.478	87.6	1.804	-7.5	0.187	4.2	0.136	108.3
8500	0.520	81.9	1.687	-14.1	0.188	-0.9	0.161	96.9
9000	0.550	77.7	1.579	-20.7	0.191	-6.0	0.186	83.7
9500	0.576	74.5	1.497	-26.6	0.194	-10.9	0.215	73.0
10000	0.596	69.9	1.411	-33.4	0.195	-16.4	0.252	65.4
10500	0.607	65.3	1.345	-40.0	0.195	-21.5	0.288	60.1
11000	0.623	56.0	1.276	-47.0	0.195	-27.9	0.320	57.3
11500	0.635	47.0	1.214	-54.2	0.195	-34.3	0.346	55.8
12000	0.666	37.5	1.146	-62.0	0.190	-41.3	0.375	53.5
12500	0.700	29.5	1.068	-69.1	0.183	-46.7	0.391	49.9
13000	0.725	23.9	0.990	-76.1	0.176	-52.1	0.405	43.7
13500	0.752	21.0	0.923	-82.2	0.175	-56.9	0.409	36.0
14000	0.766	19.6	0.869	-88.3	0.171	-61.8	0.423	26.6
14500	0.765	18.3	0.816	-94.0	0.172	-66.5	0.439	18.2
15000	0.763	17.1	0.794	-99.4	0.176	-71.9	0.455	12.0

## MCH4009

### S Parameters (Common emitter)

$V_{CE}=1V, I_C=30mA$

Freq(MHz)	$ S_{11} $	$\angle S_{11}$	$ S_{21} $	$\angle S_{21}$	$ S_{12} $	$\angle S_{12}$	$ S_{22} $	$\angle S_{22}$
500	0.489	-105.9	19.643	115.2	0.031	55.0	0.490	-66.6
1000	0.453	-142.8	11.260	94.8	0.044	52.3	0.286	-93.3
1500	0.441	-161.4	7.725	83.4	0.056	52.4	0.202	-111.9
2000	0.435	-172.7	5.906	74.8	0.068	52.5	0.158	-126.9
2500	0.432	176.2	4.789	67.3	0.082	50.9	0.135	-139.4
3000	0.433	168.2	4.041	60.3	0.094	48.4	0.117	-149.3
3500	0.435	161.4	3.509	53.7	0.105	46.0	0.099	-159.4
4000	0.434	155.5	3.125	47.3	0.117	43.0	0.083	-168.8
4500	0.433	150.1	2.821	40.9	0.129	39.6	0.069	176.7
5000	0.426	144.2	2.604	34.4	0.140	35.6	0.059	161.8
5500	0.415	137.6	2.447	28.0	0.151	31.5	0.052	150.0
6000	0.411	127.7	2.271	20.7	0.163	26.3	0.065	132.1
6500	0.413	116.6	2.129	13.3	0.173	20.9	0.083	126.0
7000	0.432	104.5	1.989	5.7	0.180	15.3	0.108	119.9
7500	0.465	93.9	1.860	-1.6	0.186	9.8	0.129	112.7
8000	0.500	85.4	1.723	-8.7	0.189	4.4	0.155	102.6
8500	0.541	80.1	1.608	-15.5	0.192	-0.5	0.181	92.0
9000	0.569	76.0	1.506	-21.8	0.194	-5.8	0.206	80.5
9500	0.594	72.9	1.428	-27.7	0.197	-10.6	0.235	70.8
10000	0.613	68.4	1.342	-34.5	0.199	-16.4	0.272	63.4
10500	0.622	63.8	1.280	-41.0	0.197	-21.3	0.308	58.2
11000	0.638	54.6	1.215	-47.9	0.197	-27.7	0.338	55.5
11500	0.650	45.6	1.155	-55.1	0.198	-34.2	0.364	53.8
12000	0.682	36.4	1.088	-62.7	0.192	-41.3	0.392	51.6
12500	0.715	28.4	1.013	-69.8	0.185	-46.9	0.406	47.7
13000	0.736	23.0	0.938	-76.7	0.179	-52.2	0.420	41.5
13500	0.760	20.1	0.872	-82.6	0.177	-57.0	0.424	34.2
14000	0.772	18.9	0.822	-88.7	0.173	-61.9	0.440	25.2
14500	0.773	17.5	0.773	-94.1	0.174	-66.2	0.452	16.9
15000	0.771	16.3	0.756	-99.3	0.177	-71.7	0.470	10.3



# MCH4009

## S Parameters (Common emitter)

$V_{CE}=3V, I_C=5mA$

Freq(MHz)	$ S_{11} $	$\angle S_{11}$	$ S_{21} $	$\angle S_{21}$	$ S_{12} $	$\angle S_{12}$	$ S_{22} $	$\angle S_{22}$
500	0.832	-42.0	11.342	143.7	0.035	67.9	0.835	-29.1
1000	0.693	-76.2	8.817	119.7	0.057	52.4	0.646	-47.2
1500	0.581	-101.6	6.951	102.7	0.068	42.9	0.507	-58.3
2000	0.519	-119.3	5.587	90.5	0.076	37.6	0.420	-65.5
2500	0.465	-135.9	4.695	80.9	0.081	35.3	0.364	-71.4
3000	0.436	-149.0	3.997	71.6	0.085	33.3	0.327	-74.4
3500	0.422	-160.1	3.507	63.8	0.090	32.4	0.300	-77.0
4000	0.414	-169.2	3.129	56.6	0.096	31.1	0.284	-78.7
4500	0.406	-177.3	2.861	49.6	0.101	30.6	0.266	-80.3
5000	0.395	-175.4	2.637	42.7	0.107	29.0	0.255	-82.3
5500	0.383	-168.1	2.397	36.3	0.114	26.4	0.257	-86.0
6000	0.359	-157.5	2.340	28.9	0.122	23.8	0.227	-90.3
6500	0.345	-145.1	2.218	21.4	0.130	20.8	0.215	-97.8
7000	0.347	-130.0	2.105	13.5	0.137	16.9	0.201	-107.2
7500	0.370	-115.2	1.981	5.8	0.141	12.7	0.188	-117.5
8000	0.400	-103.2	1.865	-1.8	0.145	8.7	0.168	-126.7
8500	0.444	-95.1	1.756	-9.0	0.151	5.1	0.147	-137.3
9000	0.480	-89.2	1.645	-16.0	0.153	0.6	0.120	-148.1
9500	0.510	-85.2	1.566	-22.3	0.157	-3.0	0.093	-163.7
10000	0.531	-79.9	1.507	-29.4	0.162	-7.8	0.075	-165.4
10500	0.547	-75.2	1.436	-36.6	0.161	-13.2	0.090	-132.6
11000	0.559	-65.3	1.371	-44.2	0.164	-18.6	0.122	-114.0
11500	0.574	-55.7	1.310	-52.0	0.167	-24.2	0.162	-106.3
12000	0.608	-45.4	1.242	-60.7	0.165	-31.6	0.206	-99.1
12500	0.645	-36.2	1.159	-68.6	0.160	-37.3	0.232	-93.2
13000	0.677	-29.8	1.076	-76.3	0.156	-42.6	0.252	-85.4
13500	0.710	-26.1	1.001	-82.9	0.154	-47.7	0.258	-76.6
14000	0.729	-24.4	0.939	-89.7	0.151	-52.4	0.266	-64.8
14500	0.734	-23.0	0.889	-95.8	0.152	-57.7	0.284	-52.0
15000	0.735	-21.6	0.828	-102.4	0.156	-63.5	0.310	-45.1

## MCH4009

### S Parameters (Common emitter)

$V_{CE}=3V, I_C=10mA$

Freq(MHz)	$ S_{11} $	$\angle S_{11}$	$ S_{21} $	$\angle S_{21}$	$ S_{12} $	$\angle S_{12}$	$ S_{22} $	$\angle S_{22}$
500	0.702	-56.3	17.369	134.5	0.030	64.1	0.751	-37.2
1000	0.548	-95.2	11.870	109.5	0.047	51.6	0.521	-56.1
1500	0.460	-120.2	8.647	94.5	0.056	47.3	0.386	-65.7
2000	0.417	-137.4	6.729	84.0	0.064	45.7	0.308	-71.4
2500	0.384	-152.5	5.523	75.6	0.072	44.9	0.263	-75.7
3000	0.371	-164.2	4.678	67.6	0.080	43.7	0.234	-77.6
3500	0.364	-173.8	4.075	60.6	0.088	42.4	0.212	-78.7
4000	0.360	-178.4	3.626	53.9	0.096	40.8	0.199	-78.7
4500	0.356	-171.7	3.298	47.5	0.105	38.7	0.188	-78.3
5000	0.347	-165.1	3.031	41.0	0.113	35.8	0.179	-78.7
5500	0.335	-158.3	2.799	34.7	0.122	33.1	0.177	-80.7
6000	0.317	-147.9	2.664	27.8	0.131	29.5	0.161	-84.8
6500	0.310	-135.5	2.518	20.6	0.140	25.5	0.150	-93.0
7000	0.320	-120.9	2.381	13.2	0.147	21.1	0.136	-104.2
7500	0.348	-107.1	2.239	5.8	0.152	16.0	0.124	-117.2
8000	0.383	-96.4	2.101	-1.4	0.157	11.5	0.103	-129.8
8500	0.428	-89.7	1.978	-8.3	0.162	7.0	0.083	-145.3
9000	0.464	-84.7	1.859	-15.0	0.164	2.9	0.057	-166.6
9500	0.493	-81.3	1.769	-21.2	0.169	-1.5	0.041	153.8
10000	0.517	-77.1	1.691	-28.0	0.173	-6.9	0.057	106.2
10500	0.533	-72.1	1.616	-35.0	0.173	-12.3	0.095	88.8
11000	0.549	-62.7	1.546	-42.2	0.176	-17.9	0.132	83.0
11500	0.564	-53.3	1.479	-49.9	0.176	-24.3	0.169	82.2
12000	0.602	-43.2	1.405	-58.1	0.175	-31.1	0.211	80.5
12500	0.639	-34.3	1.317	-65.8	0.171	-37.1	0.236	76.7
13000	0.672	-28.2	1.226	-73.5	0.165	-42.7	0.257	69.9
13500	0.704	-24.8	1.141	-80.0	0.163	-47.9	0.262	61.4
14000	0.725	-23.3	1.078	-86.6	0.160	-52.4	0.275	49.6
14500	0.728	-21.9	1.014	-92.8	0.161	-58.5	0.292	38.2
15000	0.729	-20.5	0.966	-99.0	0.163	-63.4	0.315	30.9

## MCH4009

### S Parameters (Common emitter)

$V_{CE}=3V, I_C=20mA$

Freq(MHz)	$ S_{11} $	$\angle S_{11}$	$ S_{21} $	$\angle S_{21}$	$ S_{12} $	$\angle S_{12}$	$ S_{22} $	$\angle S_{22}$
500	0.562	-72.2	22.269	125.7	0.026	62.0	0.659	-43.9
1000	0.442	-113.0	13.651	102.2	0.039	56.1	0.421	-61.7
1500	0.389	-136.8	9.560	89.2	0.049	54.2	0.302	-69.8
2000	0.364	-152.5	7.334	79.9	0.059	52.9	0.237	-74.2
2500	0.347	-165.9	5.959	72.3	0.069	52.3	0.200	-77.4
3000	0.341	-176.1	5.031	65.2	0.078	50.2	0.178	-78.2
3500	0.340	175.8	4.372	58.6	0.089	48.3	0.162	-77.7
4000	0.339	169.1	3.886	52.3	0.098	46.2	0.153	-76.0
4500	0.335	163.4	3.524	46.1	0.108	43.5	0.145	-74.3
5000	0.328	157.5	3.238	39.9	0.117	40.2	0.140	-72.7
5500	0.316	150.9	3.007	33.7	0.127	36.6	0.137	-73.7
6000	0.302	140.8	2.833	27.1	0.137	32.4	0.126	-77.4
6500	0.298	128.4	2.670	20.0	0.145	27.8	0.116	-86.6
7000	0.313	114.4	2.520	12.8	0.153	23.1	0.102	-99.7
7500	0.346	101.7	2.367	5.7	0.159	18.1	0.088	-115.9
8000	0.382	91.9	2.218	-1.4	0.164	13.3	0.070	-132.1
8500	0.428	86.2	2.088	-8.0	0.168	8.5	0.051	-156.7
9000	0.462	81.8	1.964	-14.6	0.171	3.9	0.033	156.9
9500	0.492	79.1	1.867	-20.6	0.174	-0.6	0.043	102.7
10000	0.514	75.0	1.781	-27.3	0.178	-6.1	0.075	79.7
10500	0.532	70.2	1.705	-34.1	0.180	-11.2	0.115	72.5
11000	0.549	61.0	1.628	-41.2	0.181	-17.4	0.152	70.6
11500	0.566	51.8	1.559	-48.5	0.183	-23.7	0.184	72.3
12000	0.603	41.9	1.484	-56.7	0.180	-30.6	0.224	71.7
12500	0.644	33.2	1.390	-64.3	0.175	-36.3	0.248	68.6
13000	0.675	27.2	1.295	-71.8	0.169	-41.8	0.267	62.1
13500	0.707	23.9	1.210	-78.3	0.167	-47.1	0.275	53.7
14000	0.724	22.5	1.142	-84.7	0.165	-52.1	0.289	42.7
14500	0.729	21.2	1.074	-91.0	0.165	-57.2	0.306	31.7
15000	0.730	19.9	1.032	-96.8	0.167	-62.9	0.328	24.1

# MCH4009

## S Parameters (Common emitter)

$V_{CE}=3V, I_C=30mA$

Freq(MHz)	$ S_{11} $	$\angle S_{11}$	$ S_{21} $	$\angle S_{21}$	$ S_{12} $	$\angle S_{12}$	$ S_{22} $	$\angle S_{22}$
500	0.490	-81.8	23.946	121.7	0.024	63.5	0.613	-46.5
1000	0.404	-123.0	14.101	99.2	0.036	57.8	0.381	-62.8
1500	0.368	-145.3	9.747	87.1	0.047	57.2	0.271	-69.8
2000	0.353	-159.9	7.456	78.4	0.057	56.8	0.213	-73.4
2500	0.342	-172.5	6.032	70.9	0.068	55.1	0.180	-75.7
3000	0.340	178.3	5.086	64.0	0.078	53.1	0.161	-76.2
3500	0.340	170.8	4.418	57.7	0.088	50.9	0.148	-75.1
4000	0.337	164.6	3.925	51.5	0.098	48.4	0.141	-73.4
4500	0.336	159.1	3.556	45.4	0.108	45.3	0.135	-70.8
5000	0.327	153.5	3.267	39.2	0.118	41.8	0.131	-69.6
5500	0.317	147.1	3.039	33.1	0.128	38.0	0.130	-70.0
6000	0.306	137.1	2.856	26.4	0.138	33.5	0.120	-73.8
6500	0.303	124.9	2.689	19.5	0.147	29.3	0.110	-83.6
7000	0.320	111.4	2.535	12.3	0.154	24.3	0.096	-96.2
7500	0.354	99.2	2.380	5.3	0.161	19.0	0.082	-113.2
8000	0.391	90.0	2.226	-1.7	0.165	14.2	0.062	-130.2
8500	0.435	84.6	2.096	-8.4	0.170	9.4	0.044	-158.2
9000	0.469	80.4	1.971	-14.8	0.172	4.3	0.029	146.9
9500	0.499	77.8	1.874	-20.7	0.177	0.4	0.044	92.7
10000	0.522	73.8	1.786	-27.5	0.180	-5.4	0.078	75.3
10500	0.537	69.3	1.709	-34.2	0.182	-10.4	0.120	69.4
11000	0.555	59.9	1.634	-41.3	0.184	-16.6	0.154	68.1
11500	0.573	50.9	1.564	-48.6	0.184	-22.9	0.187	69.9
12000	0.611	41.2	1.487	-56.7	0.182	-30.1	0.225	70.0
12500	0.649	32.4	1.394	-64.2	0.177	-36.0	0.248	67.0
13000	0.681	26.5	1.298	-71.6	0.172	-41.1	0.268	60.7
13500	0.711	23.4	1.210	-78.1	0.169	-46.4	0.278	52.2
14000	0.730	22.0	1.142	-84.6	0.166	-51.5	0.291	40.9
14500	0.735	20.6	1.074	-90.7	0.166	-56.6	0.309	30.6
15000	0.734	19.3	1.037	-96.5	0.169	-62.7	0.332	23.0

- Specifications of any and all SANYO Semiconductor products described or contained herein stipulate the performance, characteristics, and functions of the described products in the independent state, and are not guarantees of the performance, characteristics, and functions of the described products as mounted in the customer's products or equipment. To verify symptoms and states that cannot be evaluated in an independent device, the customer should always evaluate and test devices mounted in the customer's products or equipment.
- SANYO Semiconductor Co., Ltd. strives to supply high-quality high-reliability products. However, any and all semiconductor products fail with some probability. It is possible that these probabilistic failures could give rise to accidents or events that could endanger human lives, that could give rise to smoke or fire, or that could cause damage to other property. When designing equipment, adopt safety measures so that these kinds of accidents or events cannot occur. Such measures include but are not limited to protective circuits and error prevention circuits for safe design, redundant design, and structural design.
- In the event that any or all SANYO Semiconductor products (including technical data, services) described or contained herein are controlled under any of applicable local export control laws and regulations, such products must not be exported without obtaining the export license from the authorities concerned in accordance with the above law.
- No part of this publication may be reproduced or transmitted in any form or by any means, electronic or mechanical, including photocopying and recording, or any information storage or retrieval system, or otherwise, without the prior written permission of SANYO Semiconductor Co., Ltd.
- Any and all information described or contained herein are subject to change without notice due to product/technology improvement, etc. When designing equipment, refer to the "Delivery Specification" for the SANYO Semiconductor product that you intend to use.
- Information (including circuit diagrams and circuit parameters) herein is for example only; it is not guaranteed for volume production. SANYO Semiconductor believes information herein is accurate and reliable, but no guarantees are made or implied regarding its use or any infringements of intellectual property rights or other rights of third parties.

This catalog provides information as of June, 2006. Specifications and information herein are subject to change without notice.